

**SHORT
FORM
CATALOG**

THE TECHNICAL MATERIEL CORPORATION



Radio Transmitters,
Radio Receivers and
Antennas for
UHF, VHF, HF, MF, LF,
VLF and ELF

Antenna accessories

Transportable installations

Single and independent
sideband exciters and
terminals

Frequency shift terminal
and transmitting
equipment

MAIN OFFICE	THE TECHNICAL MATERIEL CORPORATION 700 Fenimore Road Mamaroneck, New York	Area Code 914 698-4800 TWX 914-835-3782
CANADIAN SALES	TMC (CANADA) LTD. RR #5 Ottawa, Ontario, Canada	Area Code 613 822-0244
SOUTHWESTERN REGION	TMC SYSTEMS (ARIZONA) INC. Unit 26 930 West 23rd St. Tempe, Arizona	Area Code 602 967-7874 TWX 910-950-1943
SPRINGFIELD VIRGINIA	THE TMC SYSTEMS AND POWER CORP. 6621 Electronics Dr. Springfield, Va.	Area Code 703 354-7400 TWX 710-832-9826
SOUTHEASTERN REGION	TMC SYSTEMS (FLORIDA) INC. P. O. Box 1525 Pompano Beach, Fla.	Area Code 305 943-4310 TWX 510-956-9879
EUROPE	TMC SYSTEMS AG Haldenstrasse 37 Luzern, Switzerland	Tel. 20144 TLX 57144

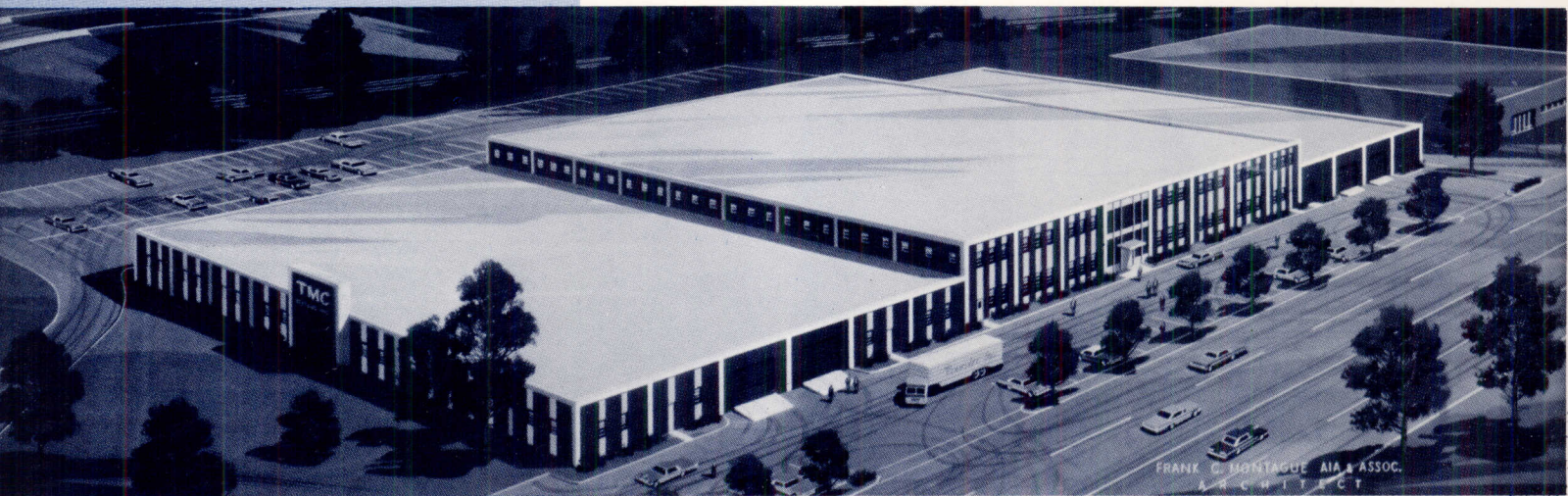

Plugs and connectors
Integrated circuits
Crystal filters
Compensated oscillators
Real time measuring
equipment
Synthesizers
Radio frequency
transformers
Transmitter test
equipment
Diesel Engines
Diesel Generators
No-break power
installation, solid state
or rotary
Field engineering
Training for radio
operators
Aeronautical installation
and service

SALES REPRESENTATIVES:

Aeromarine Corporation
1112 Magazine Street
New Orleans, Louisiana 70130
504-522-0217
Mr. Robert Levi

Dyna-Reps
200 South Grants Lane
P.O. Box 5154
Fort Worth, Texas 76108
817-732-6621
Mr. James S. Neely
Mr. Ted Carter

Dyna-Reps
6400 Southwest Freeway
Suite 110
Houston, Texas 77036
713-782-0311
Mr. James C. Neely

Gassner and Clark
6644 Northwestern Avenue
Chicago, Illinois 60645
312-764-6121
Mr. Frank Gassner

Faust Associates
606 Edmondson Avenue
Baltimore, Maryland 21228
301-744-6403
Mr. Ben Faust

Gentry Associates, Inc.
6646 Central Avenue
St. Petersburg, Florida 33733
813-347-5131
Mr. Richard Gentry

Richard J. Homer and Associates
14436 Sherman Way
Van Nuys, California 91405
213-781-1236
Mr. Richard Homer

Industrial Electronic, Inc.
P.O. Box 135
656 South Queen Street
Honolulu, Hawaii 96813
Mr. Richard Yamaoka
Mr. Nick Carter
Mr. Ed Dorman

Techcom Associates
P.O. Box 71
Chelmsford, Massachusetts 01824
617-256-3431
Mr. William Young
Mr. John Tamanakis

Mr. Walter Werner
131 Woodland Manor
New Shrewsbury, New Jersey 06820
203-655-1133

Westec Electronics
4117 El Camino Way
Palo Alto, California 94306
415-327-5850
Mr. Tom Collins

Westec Electronics
P.O. Box 781
El Segundo, California 90246
213-322-1561
Mr. Bill Vanbebber
Mr. Shawn McCarty

P.O. Box 66521
Burien Branch
Seattle, Washington 98166
206-243-7070
Mr. E. J. (Red) Underwood



Ray de Pasquale
PRESIDENT



George C. Dixon
EXEC. VICE PRES.



John Galione
SENIOR VICE PRES.



Ernest A. Matson Jr.
VICE PRES. ADM.



William Deans
VICE PRES. GOVT. COM'L SALES

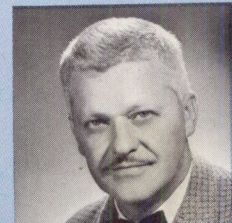

Alexander Lennox
VICE PRES. MKTG.

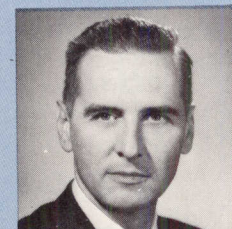

David A. Hillmann
VICE PRES. INT'L MKTG.

350 TO 1000 WATT GENERAL PURPOSE

350 WATTS

TMC's Models GPT-350 general purpose transmitters are specifically designed to fulfill requirements of general purpose communications from 2 to 32 Mcs. Models GPT-350 provide AM, CW, MCW, and FSK modes of operation and three oven crystal control positions or external VMO, with a wide choice of audio inputs and push-to-talk operation. Modular construction of this group of transmitters affords many customer options as to operational modes and shock or base mounts. The final linear amplifier allows economical transition to sideband modes of operation when required. GPT-350 are housed in sturdy 19" cabinets and provided with filtered forced air cooling.



MODEL GPT-750

BULLETIN 1007

750 WATTS

The TMC GPT-750 series of general purpose transmitters emphasize the dependable characteristics that have been engineered into these sturdy hardworking transmitters. The GPT-750 is in service aboard ships, in civil defense installations, in ham shacks, and at commercial and military shore stations all over the world. The GPT-750 series feature continuous tuning from 2-32 megacycles and provide 750 watts PEP SSB and ISB, 750 watts high level AM, and 1000 watts CW and FSK operation. GPT-750 are housed in attractive reinforced metal cabinets with filtered forced air for cooling.

AN/FRT-17A

AN/FRT-55

1000 WATTS

GPT-1K series of transmitters by TMC includes building block versatility for customer selection incorporating AM, CW, MCW, and FSK modes of operation from 2 to 32 mcs with three oven stabilized crystal positions or external VMO operation. A wide choice of audio inputs with push-to-talk operation is available. Simplex operation is provided by means of a coaxial antenna relay. The 1000 watt final linear amplifier affords an economical means of changing to sideband operation at a future date.

THESE TRANSMITTERS ARE AVAILABLE WITH SOLID STATE POWER SUPPLIES

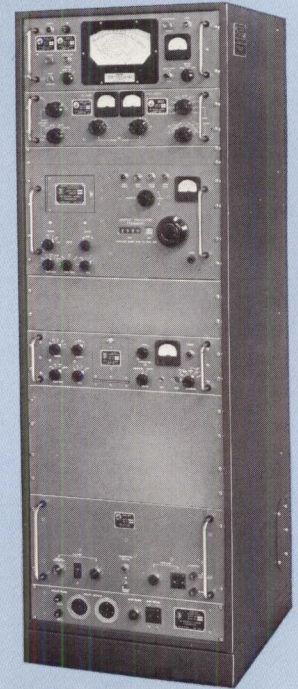

MODEL GPT-350

BULLETIN 1002

MODEL GPT-1K

BULLETIN 1002

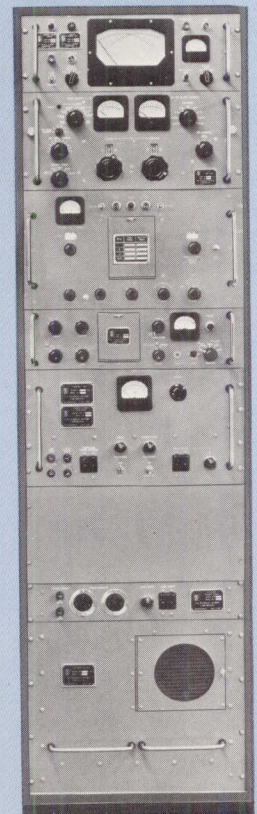

POSE AND SSB TRANSMITTERS

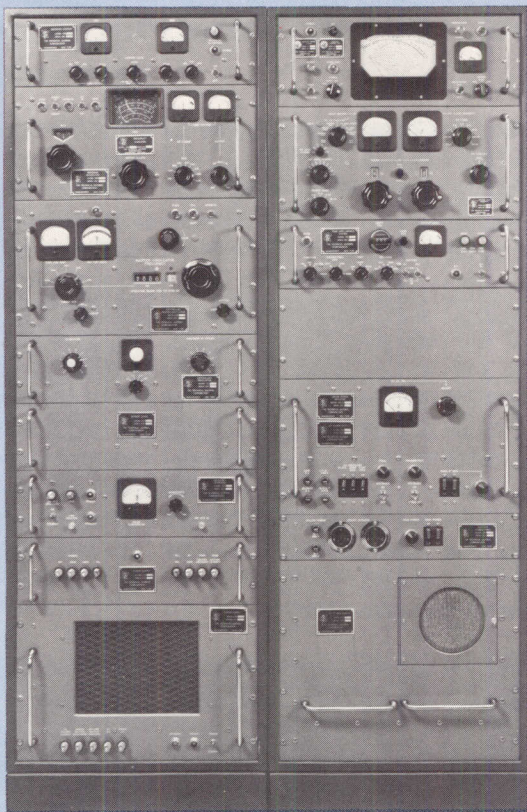

1000 WATTS SSB (SYNTHESIZED)

Models SBT-1K synthesized transmitters provide ISB, SSB, AM, CW, FSK and FAX modes of operation over the frequency range of 2 to 32 megacycles with 1000 watts PEP output and 100 cycles incremental tuning with stability and accuracy of 1 part in 10^8 per day. Models SBT-1K feature 350 to 3300 cycles or 250 to 7500 cycles in both upper and lower sidebands dependent upon the model ordered. Standing wave ratio indicators or complete antenna tuning systems are provided in the options of the five models offered in this series. Coaxial antenna relay that mutes the receiver upon transmitting is provided to facilitate half duplex operation. These transmitters can be provided with either base or shipboard shock mounts in attractive semi-pressurized cabinets.

MODEL SBT-1K

BULLETIN 1001

AN/FRT-70

AN/FRT-81A

MODEL SBT-350

BULLETIN 1003

350 WATTS SSB

The SBT-350 family of 18 transmitters covers the frequency range of 2-32 mcs and provides AM, SSB, ISB, AM, CW and FSK modes of operation with a minimum of 40 db signal to distortion ratio at full PEP output. SBT-350 transmitters use TMC PAL-350 linear amplifier, which has received OCD and Canadian DOT approval. This family of transmitters is built on the building block principle, using many standard TMC items, such as narrow or wide band exciters, the ATS Antenna Tuning System, the XFK Frequency Shift Keyer, the VOX-5 Variable Frequency Oscillator and the TIS-3 Tone Intelligence System. All SBT-350s are housed in semi-pressurized cabinets and can be provided with either base or standard shipboard type of shock mounts. A coaxial antenna relay, which mutes the receiving circuit, is provided for half duplex type of operation. Voice operated relay with anti-trip features and adjustable gain and squelch is also available.

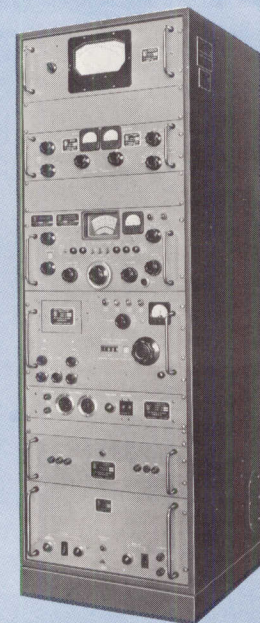

MODEL SBT-1K

BULLETIN 1001

1000 WATTS SSB

The SBT-1K unsynthesized group of transmitters are general purpose transmitters providing 1000 watts output over the frequency range of 2 to 32 megacycles, with stability of one part on 10^6 and a minimum signal to distortion ratio of 35 db at full PEP output. Eleven different configurations of the SBT-1K transmitter have been manufactured and sold, using the PAL-1K linear amplifier as the heart of the system. The PAL-1K linear amplifier has received OCD and DOT approval. 50 or 70 ohms unbalanced output is available dependent upon the model of the SWR or ATS-2 ordered. Coaxial antenna relay that mutes the receiver upon transmit is provided to facilitate half duplex operation. Models SBT-1K are furnished in semi-pressurized cabinets with filtered forced air cooling and are available in either 350 to 3300 cps, or 250 to 7500 cps operation in both upper and lower sideband. Models SBT-1K provide SSB, ISB, AM, CW, FSK and FAX operation over the total frequency range.

AN/URT-19(v)

AN/FRT-53

AN/FRT-57

AN/FRT-56

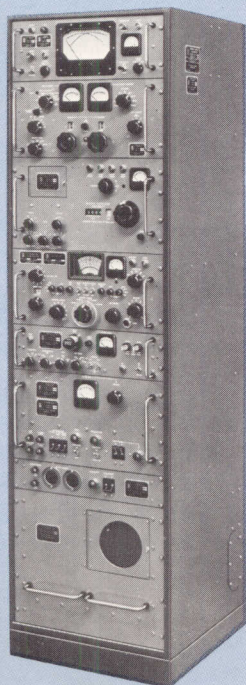

10 KW-40 KW GENERAL PURPOSE

AN/FRT-52()

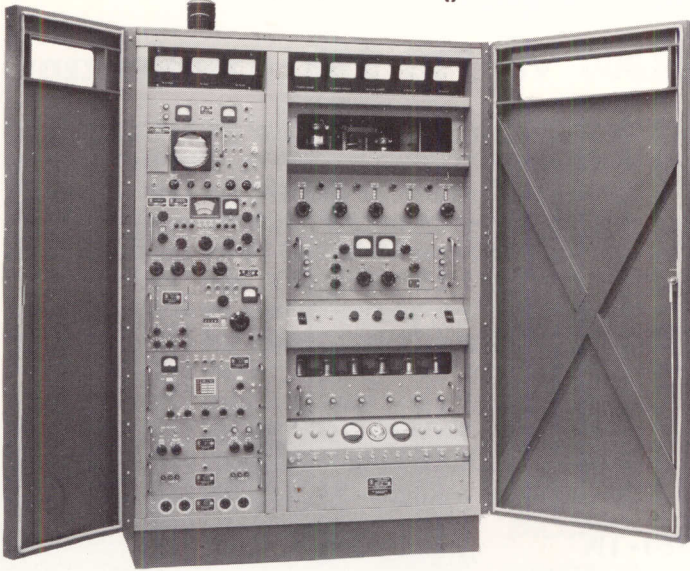

MODEL GPT-10K

BULLETIN 1008A

TMC's Model GPT-10K general purpose radio transmitters provide SSB, ISB, AM, CW, FSK and FAX modes of operation from 2 to 28 Mcs at 10,000 watts PEP and 5,000 watts average power. Under conditions of a 64 tones voice frequency modulation GPT-10K transmitters provide approximately 50 Kw PEP at 20% duty cycle with 35 DB signal to distortion ratio. The linear amplifiers provide 20 Kc band pass, throughout the tuning range, between 3 DB voltage points. GPT-10K transmitters have found service in commercial and governmental installations worldwide, in fixed station, mobile and shipboard application. The modular building block concept of this series of transmitters provides many customer options with approximately 24 individual models to select from. The final PI-L output of this transmitter will match a load with a maximum VSWR of 2 to 1 with either balanced or unbalanced output.

TECHNICAL SPECIFICATIONS

FREQUENCY RANGE: 2-28 megacycles bandswitched • **OPERATING MODES:** SSB, ISB, CW, AM, FSK and FAX. • **POWER OUTPUT:** 10,000 watts to 2 tone PEP signal to distortion ratio at least 35 db. 5000 watts average CW or FSK. • **CARRIER INSERTION:** —55 db to full output. • **HARMONIC SUPPRESSION:** Second harmonic at least 50 db down from PEP output,

third harmonic at least 65 db down from PEP output. • **OUTPUT IMPEDANCE:** 50 or 70 ohms unbalanced. 600 ohms balanced. Pi-L network will match a load with VSWR of 2:1 maximum. • **VSWR PROTECT:** Meter with preset VSWR of up to 2:1 disables transmitter when this value is reached.

THESE TRANSMITTERS ARE AVAILABLE WITH SOLID STATE POWER SUPPLIES AND VAPOR COOLING.

AN/FRT-39()

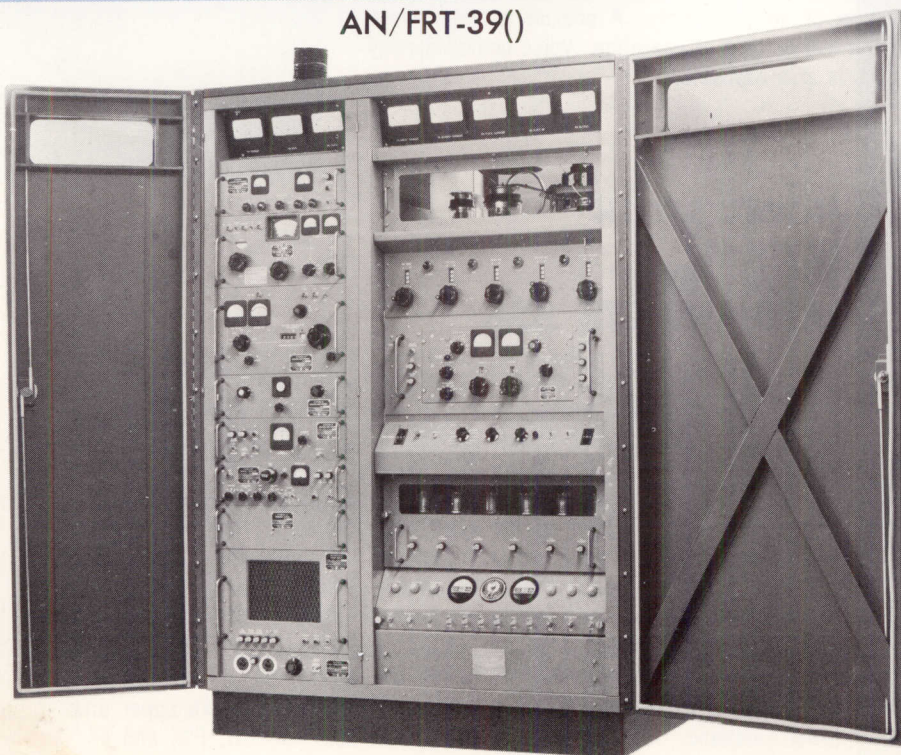

MODEL GPT-10K-R

GPT-10K-AC

BULLETIN 1005

Model GPT-10K-R and GPT-10K-AC Synthesized General Purpose Transmitters provide SSB, ISB, AM, CW, FSK, and FAX modes of operation from 2-28 megacycles at 10,000 watts PEP and 5,000 watts average power. Synthesized accuracy and stability of 1 part in 10^8 with 100 cycle incremental tuning throughout the frequency range are featured in these transmitters.

With 64 tone voice frequency modulation, these transmitters provide approximately 50 kw PEP at 20% duty cycle with 35 db signal to distortion ratio. The modulator building block concept provides ease in operation and maintenance, with most of the units installed on tilting drawer slides.

SINGLE SIDE BAND TRANSMITTERS

MODEL GPT-40K

BULLETIN 1009

Models GPT-40K general purpose transmitters are conservatively rated at 40 Kw PEP and 20 Kw average power output. With 64 tone voice frequency modulation, GPT-40K will deliver approximately 100 Kw PEP on a 20% duty cycle with better than 35 db signal to distortion ratio.

A newly designed automatic load and drive control is incorporated with front panel control for adjustment of the level at which the ALDC takes effect.

Models GPT-40KA and GPT-40KF transmitters are completely bandswitched from the front panel and contain a built-in spectrum analyzer for operator and maintenance adjustment of the transmitter. 50 or 70 ohm unbalanced output with 3/8" EIA flanges or 600 ohm balanced output is available at the option of the user, and the Pi-L tuning network of the final amplifier will match a load with a maximum VSWR of 2:1.

AN/FRT-40

AN/FRT-54

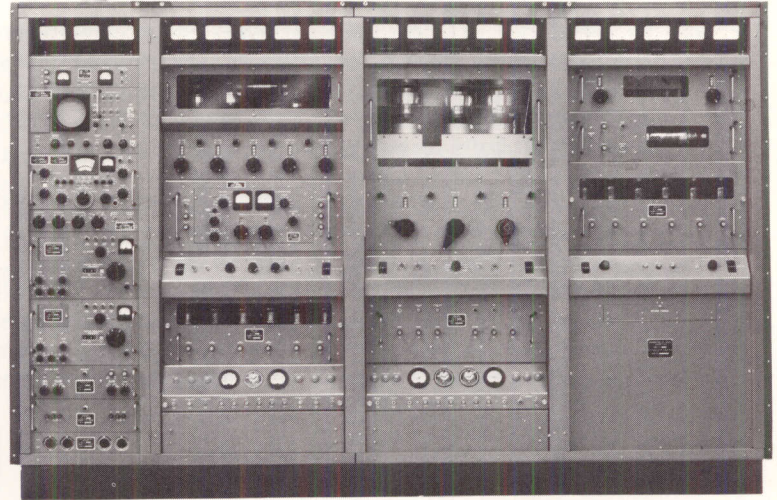

TECHNICAL SPECIFICATIONS

FREQUENCY RANGE: 2-28 megacycles • **MODES OF OPERATION:** SSB, ISB, AM, CW, FSK, and FAX. • **POWER OUTPUT:** 40,000 watts PEP, signal to distortion ratio at least 35 db. 20,000 watts PEP, signal to distortion ratio at least 40 db. 20,000 watts average, CW or FS. • **TUNING:** All tuning and band-switching controls are on the front panel. No plug-in components or mechanical adjustments. Self-cleaning contacts on RF band-switches. • **SPURIOUS SIGNALS:** At least 60 db below full PEP output when using SBE-3 and SBE-4. At

least 55 db below full PEP output when SBE-2 is used. • **CARRIER INSERTION:** —55 db to full PEP output. • **HARMONIC SUPPRESSION:** Second harmonic at least 50 db down from PEP output. Third harmonic at least 65 db down from PEP output. • **AUDIO RESPONSE:** SBE-3 Crystal lattice filters flat within ± 1.5 db 250-7500 cps. SBE-4 Crystal lattice filters flat within ± 1.5 db 250-6000 cps. • **VSWR PROTECT:** Meter with preset VSWR of up to 2:1 disables transmitter when this value is reached.

THESE TRANSMITTERS ARE AVAILABLE WITH SOLID STATE POWER SUPPLIES AND VAPOR COOLING.

MODEL GPT-40KE

BULLETIN 1006

Model GPT-40KE synthesized general purpose transmitter provides SSB, ISB, AM, CW, FSK, and FAX modes of operation from 2-28 megacycles, in 100 cycle-steps with minimum stability and accuracy of 1 part in 10^8 per day. The synthesizer portion of the GPT-40KE may be "locked" to a station standard if higher stability of the transmitted signal is desired.

GPT-40KE amplifiers provide greater than 20 kc bandwidth between 3 db voltage points over the entire frequency range of the transmitter.

With 64 tone voice frequency modulation, GPT-40K transmitters will deliver approximately 100 Kw PEP on 20% duty cycle with better than 35 db signal to distortion ratio.

AN/FRT-40()

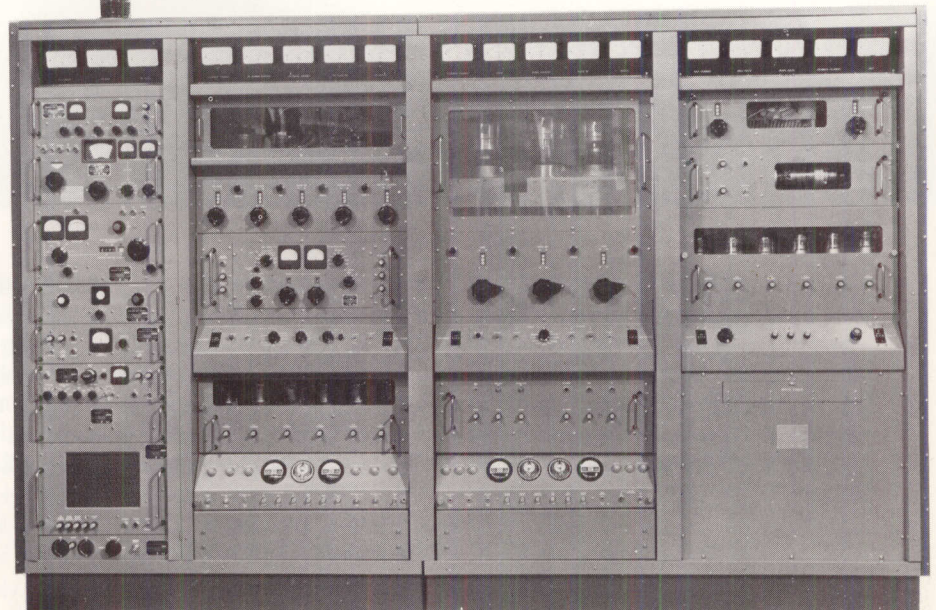

POINT-TO-POINT HI- POWER

TMC Model GPT-200K General Purpose Synthesized Transmitter features 260,000 synthesized channels from 2 to 28 megacycles at 200 KW PEP output in SSB, ISB, AM, AM equivalent, CW, FSK, and FAX operating modes. Under conditions of 64 tone modulation, this transmitter will deliver approximately 500,000 watts peak power at 20% duty cycle, with better than 35 db signal to distortion ratio, or 1,000,000 watts on an absolute peak basis.

The GPT-200K features synthesized frequency control with 100 cps incremental tuning throughout the tuning range, with stability and accuracy of 1 part in 10^8 for a 24 hour period. The synthesizer may be "locked" to a higher stability station standard if desired. The overall minimum bandwidth of the linear amplifier is at least 20 kc between 3 db voltage points over the entire frequency range. 40 kw, 10 kw, and 1 kw outputs may be connected to antenna for emergency or reduced power. Front panel bandswitching and tuning reduces frequency changeover time to a minimum (no plug-in components or mechanical adjustments). Bandswitches are self-cleaning, with no rolling contacts.

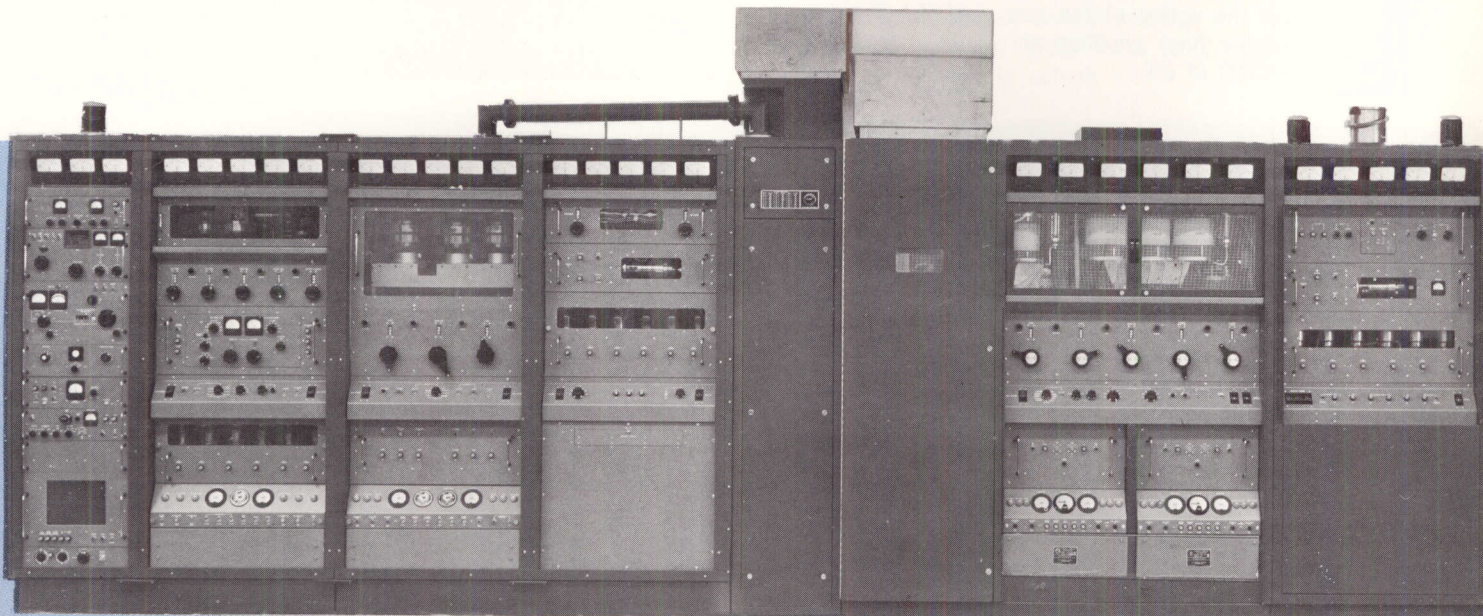

MODEL GPT-200KA

BULLETIN 1014B

AN/FRT-62

FREQUENCY RANGE: 2 to 28 megacycles bandswitched. • **OPERATING MODES:** SSB, ISB, CW, AM, AME, FSK and FAX. • **POWER OUTPUT:** GPT-200K, 200 kw two tone PEP. Signal to distortion ratio at least 35 db. 125 kw, CW or FSK. GPT-100K, 100 kw two tone PEP. Signal to distortion ratio at least 45 db. 60 kw average, CW or FSK. • **OUTPUT IMPEDANCE:** 50 ohms nominal unbalanced, 6 $\frac{1}{8}$ " EIA flange, 600 ohms balanced. Pi-L network will match a load with VSWR of 2:1 maximum. • **STABILITY:** 1 part in 10^8 per day. • **UNWANTED SIDEBAND REJECTION:** 500 cps single tone 60 db down from full PEP output. • **SPURIOUS SIGNALS:** (As per CCIR Standards) At least 60 db below full PEP output.

MULTIMODE TRANSMITTERS

One hundred kilowatt PEP output with 260,000 synthesized channels from 2-28 megacycles for SSB, ISB, AM, AM equivalent, CW, FSK and FAX operation are featured in TMC's Model GPT-100K transmitter. Under conditions of 64 tone modulation, this transmitter will deliver approximately 250,000 watts peak power at 20 per cent duty cycle with better than 35 db signal to distortion ratio. The transmitter is housed in an attractive cabinet assembly and constructed on a modular basis for ease in installation, operation, and maintenance. Access to all but one of the high level stages and almost all operating components is available from front. Positive contact is obtained by bandswitched tuning elements with no rolling contacts. Air cooling is used throughout and the transmitter is so designed that the intake and exhaust may be ducted to the exterior of a building or mobile container.

THESE TRANSMITTERS ARE AVAILABLE WITH SOLID STATE
POWER SUPPLIES AND VAPOR COOLING.

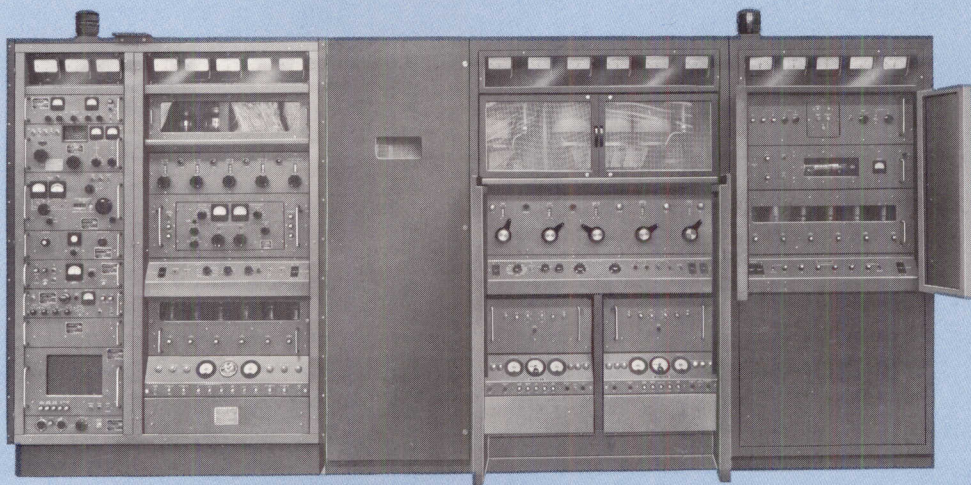

MODEL GPT-100K

BULLETIN 1016

- **CARRIER INSERTION:** —55 db to full PEP output.
- **HARMONIC SUPPRESSION:** All harmonics better than 65 db down from full PEP output (no greater than 50 milliwatts).
- **AUDIO RESPONSE:** Crystal lattice filters flat within ± 1.5 db 250 to 7500 cps ± 25 cps.
- **SPECIAL FEATURES:** ALDC (Automatic Load and Drive Control) is provided to improve linearity, limit distortion, and deliver a relatively constant RF output level during high modulation peaks or load changes. Front panel control allows adjustment of the level at which the ALDC takes effect or switching off the ALDC, if desired.
- **COOLING:** Filtered forced air cooling, sempressurized cabinet. Vapor cooling available as optional.
- **NOISE:** Power supply ripple 55 db down from full PEP output. Other, 70 db down from full PEP output.
- **PRIMARY POWER REQUIREMENTS:** Transformer Primary tapped for 190/200/210/220/240/250 volts AC, 50-60 cycles, 3 phase
- **PRIMARY POWER REQUIREMENTS:** GPT-200K, approximately 400 kw. GPT-100K, approximately 250 kw. Primary of transformer may be connected to either DELTA or WYE input.
- **VSWR PROTECT:** De-energizes transmitter when preset VSWR (up to 2:1) is exceeded.

10 KW BROADCAST TRANSMITTER BCT-10KA

NEW

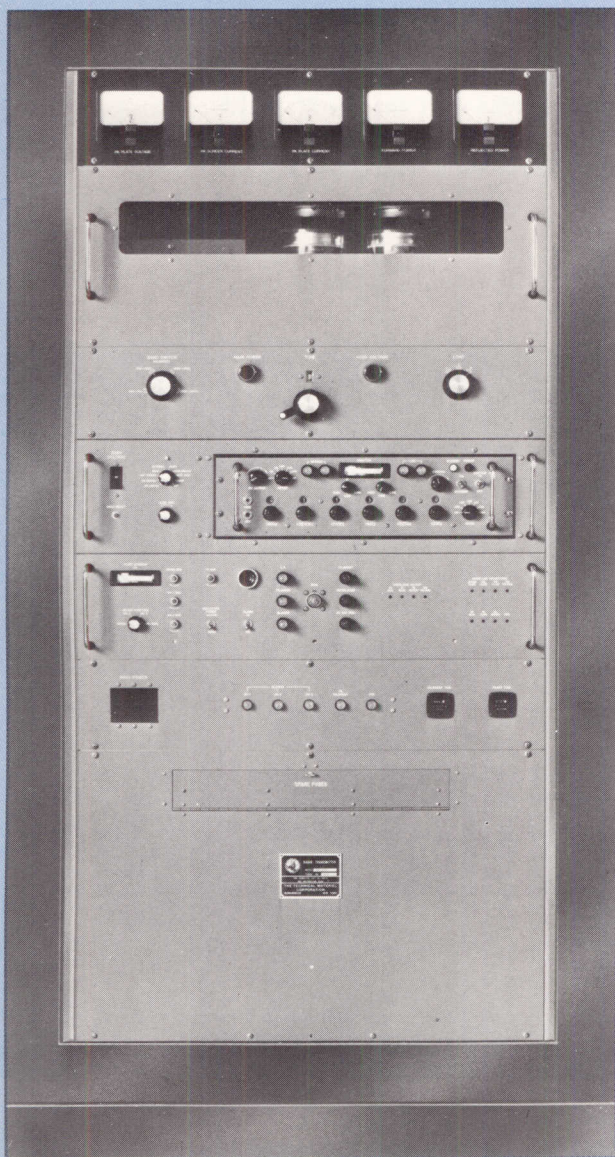

MODEL BCT-10KA
BULLETIN 1021

450 to 2000 KHz

- SINGLE KNOB TUNING
- LIGHTWEIGHT AND COMPACT
- SOLID STATE RELIABILITY
- ULTRA STABLE
- HIGH FIDELITY TRANSMISSION
- MULTI-MODE OPERATION

The BCT-10KA is a high power, air cooled, multi-mode MF broadcast transmitter designed to provide an extremely high-fidelity transmission in the 450 to 2000 KHz range, while employing the advantages of compactness, simplicity and economy.

This transmitter is especially suitable for air and other transportable applications due to its small physical size and weight.

The simplicity of the tuning controls coupled with the digitally controlled synthesized exciter, make it possible to retune to a new frequency within a matter of seconds. The versatility of the multi-mode exciter provides operation in CW, AM, AME, SSB, ISB, and FSK Modes. The frequency indicator displays an instantaneous reading of the carrier frequency.

Power cutback can be "readily" adjusted by the RF gain control for any desired output power level, while still maintaining 100% modulation, with nominal distortion as depicted in the specifications.

FREQUENCY RANGE: 450 to 2000 KHz. • **MODES OF OPERATION:** CW, AM, AME, SSB, ISB and FSK. • **POWER OUTPUT:** 10,000 watt average carrier power. • **OUTPUT IMPEDANCE:** 50 ohms unbalanced. Will match any antenna with a VSWR of less than 2:1. • **FREQUENCY STABILITY:** 1 part 10^6 per day for ambient temperature change of 15° C. within the range of 0-50° C. 1 part in 10^7 or 10^8 per day (optional extra). • **TUNING SYSTEM:** Continuous tuning across the band with all power tuning and band switching controls on the front panel. • **VSWR PROTECTION:** Automatic protection against mismatch exceeding 2 to 1 is provided. A higher VSWR can be tolerated with reduced power output. • **SPURIOUS SIGNALS:** Spurious signals greater than 120 Hz removed from the carrier at least 50 db. below carrier output. • **NOISE LEVEL:** Noise level is at least 60 db. down from either

tone of a two tone test. • **CARRIER INSERTION:** Carrier insertion continuously variable from full carrier to -55 db. • **HARMONIC SUPPRESSION:** Harmonics are at least 50 db. below full carrier output. • **AUDIO RESPONSE:** 1. AM - 100 Hz to 10 KHz \pm 2 db. 2. SSB - 350 to 3.5 KHz \pm 1.5; 250 to 3.04 KHz \pm 1.5 (optional extra); 250 to 6.08 KHz \pm 1.5 (optional extra). • **AUDIO INPUT:** 600 ohm balanced or unbalanced. -20 dbm. input to +10 dbm. -20 dbm. input will provide full RF output. • **ALTITUDE:** The transmitter is designed to provide full output at an altitude of 10,000 feet. • **INSTALLATION DATA:** Weight: Approximately 1250 lbs. Height: 65 inches. Width: 32 inches. Depth: 35 inches. • **PRIMARY POWER:** 208 three phase, 50/60 Hz. Primary of the transformer may be connected to either delta or "wye" input.

2-30 MHz SERIES 2.5 KW. TRANSMITTERS

NEW

The TMC GPT-2.5 transmitter series is a group of system oriented equipments which will fulfill a broad range of HF communication applications without modification or design compromise. The GPT-2.5 is especially suitable for operation in high performance transportable or fixed station SSB transmitting installations on land, sea or air. The GPT-2.5 will provide 2500 watts PEP and average. The Linear Amplifier requires only 100 milliwatts RF drive power, and, in the automated version, will automatically tune from 2-30 MHz in 20 seconds or less. Prepositioning of the Amplifier tuning elements is accomplished directly from information taken from the exciter, thus making the Linear Amplifier suitable for use with many TMC exciters capable of producing 0.1 watts of drive power and furnishing the prepositioning information. In the completely manual configuration, the Linear Amplifier can be driven by any conventional exciter providing a power output of 0.1 watt into 50 ohms in the frequency range of 2 to 30 MHz.

The new specifications of the Federal Communications Commission for sideband operation are very stringent, both as to stability and spurious emission, including harmonics. This dictates the care that must be taken in choosing an exciter, since frequency stability for the transmitter is determined in the exciter. All TMC synthesized exciters will meet both the FCC and CCIR stability specifications. Other TMC exciters meet these specifications on fixed frequencies by high quality oven oscillators and precise oven control.

As to harmonics and spurious, TMC transmitters are traditionally excellent in this regard. The use of an antenna tuner obviously further attenuates harmonic and spurious emission. TMC has gone even further, however, and has developed both fixed and switched optional filters to enable all of these transmitters to meet all standard harmonic and spurious specifications.

This transmitter series may be provided in various configurations most adapted to customer requirements. Units are available with completely manual tuning or may be automatically tunable from the front panel or, alternatively, configured for remote tuning. Manual override of automatic tuning features are an inherent design bonus in all TMC automated transmitters.

A variety of multi-mode exciters, settable automatic power output level control, automatic high-low band antenna coax switch selection (usable for antenna send-recvie switching), settable VSWR level protection, programmed or automatic antenna tuning features can be provided to meet customer needs. The versatility of this series of transmitters, with the many features already available, make it exceptionally valuable for the many fixed and transportable applications in this power range.

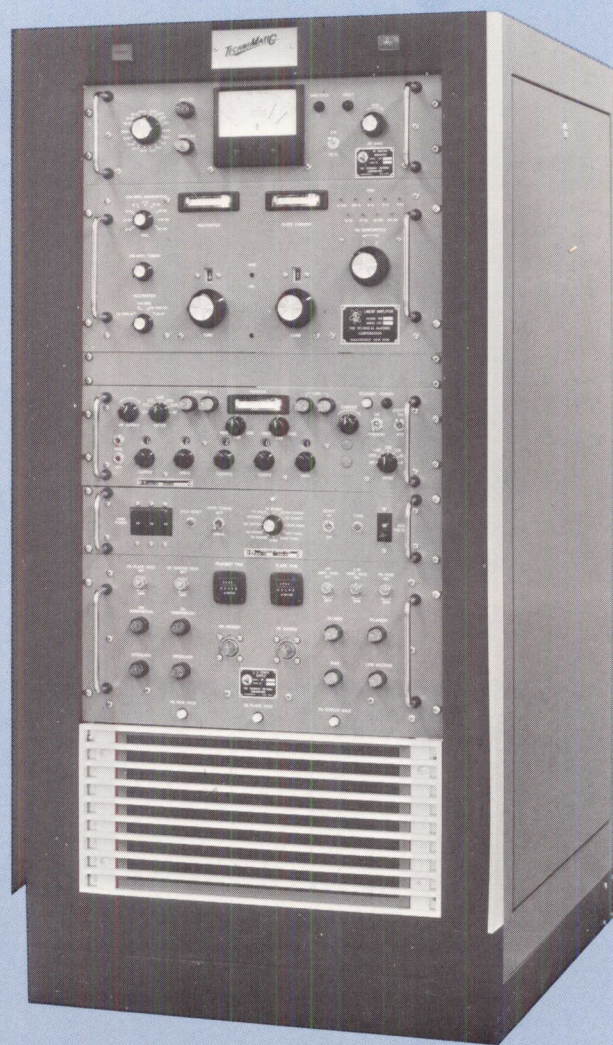

MODEL GPT-2.5
BULLETIN 1019

SOLID STATE TRANSMITTER/RECEIVER

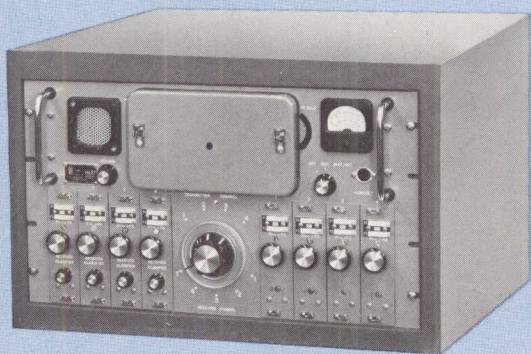

MODEL TTR-20

BULLETIN 1004

SOLID STATE SSB T/R

For harbor circuits, pleasure yachts, extension telephone services, pipeline operations, tactical voice circuits, amphibious landing operations, this highly versatile solid state transmitter/receiver has four fixed tuned channels in the frequency range of 2.0-24 mcs and provides 100 watts PEP output. A wide variety of power supplies, including 115/230 VAC and external converters for 12, 24 and 32 VDC, makes this unit ideal in almost any operational environment. Remote operation of both the transmitter and receiver in either simplex or duplex modes of operation is available.

NEW



The unit is also available in a transit/operating case for mobility. Accessory equipment includes: pre-tuned antenna tuner; telephone pushbutton remote control system, carbon or dynamic microphone and oven control of operating crystals in both the send and receive modules.

VERY LOW FREQUENCY TRANSMITTER

MODEL GPT-10KLF

BULLETIN 1015

10 KW GENERAL PURPOSE TRANSMITTER

Model GPT-10KLF transmitter will provide 15 kc independent sideband operation at 10 kw PEP output with 100 cycle tuning increments from 5 kc to 540 kcs with a stability of 1 part in 10^8 per day. Bandwidth output of this transmitter is limited principally by the transmission media and would be more limited at the low end of the frequency range.

Output circuitry is broadband tuned in two stages across the total band. The transmitter is cooled by filtered forced air cooling and all tubes and components less the finals are accessible from the front of the unit. Shipboard mil/spec shock mounts are available for mobile use.

GPT-10KLF can be used for communication circuits, sonar head drivers, or for laboratory type shaker tables requiring variable frequency and high power drive. Approximately 85% of the parts used in this transmitter are directly interchangeable with the widely acceptable AN/FRT-39 series of transmitters currently in wide use throughout the world.

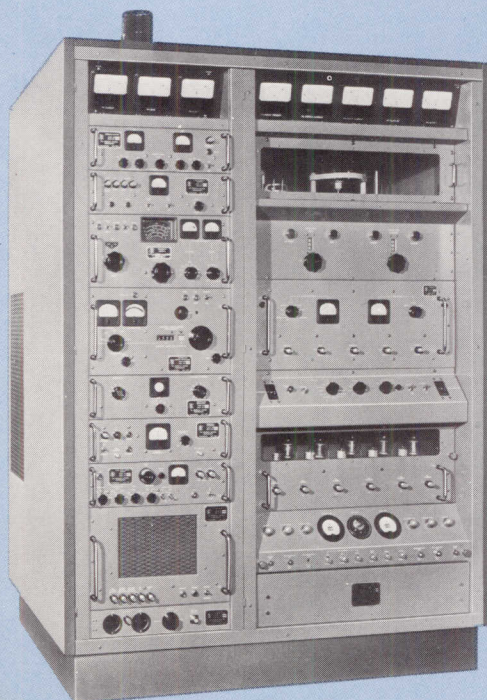

AVAILABLE WITH SOLID STATE POWER SUPPLIES AND VAPOR COOLING.

SOLID STATE EXCITERS

SOLID STATE EXCITER

The TMC Model SME-6 Solid State Exciter, provides rapid selection of any one of up to ten crystal controlled channels in the 1.6 to 30 mc. range, with a basic CW capability and optional plug-in modules for USB, LSB, ISB, AM and FSK/FAX operating modes. When using the FSK/FAX option, only nine channels are available. Frequency stability meets FCC and CCIR specifications. A unique voice processing circuit provides a much higher average power level in the speech envelope and prevents overloading the associated RF liner amplifier. Remote control of channel selection, operating mode, power output level plus selected carrier insertion level is available as options. This versatile Exciter, with options bought only as and when needed, is ideal for a wide range of applications.

FREQUENCY RANGE: 1.6-30 mc. on ten preset channels

MODES OF OPERATION: CW with optional USB or LSB, ISB; AM, FSK/FAX

POWER OUTPUT: 0 to 250 milliwatts PEP, adjustable.

MODEL SME-6
BULLETIN 2030

NEW

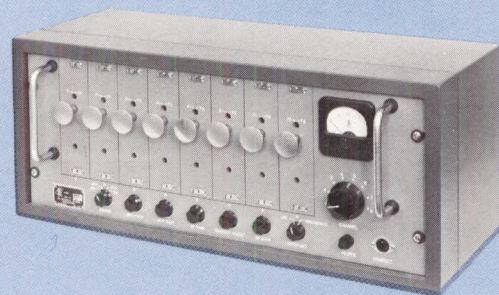

MODEL STE-5
BULLETIN 2032

NEW



SOLID STATE "STRIP" EXCITER

This solid state "strip" exciter occupies but 1 3/4" of panel space, requires but 16 watts of power to operate and four front panel plug-in RF modules from 2-4, 4-8, 8-16 and 16-24 mcs provides 100 milliwatts of RF power to a 50 ohm load. Oven control of crystals is available for stability of at least 1 part in 10⁶ per day. The low heat generated by this unit allows rack mounting of many exciters in a standard 19" relay rack.

Provides USB, LSB, CW, MCW, AME, AFAX and AFSK modes.

VERY LOW FREQUENCY EXCITER

MODEL SBG-1LB
BULLETIN 2013

LOW FREQUENCY SIDE BAND GENERATOR

Model SBG-1L Low Frequency Sideband Generator provides SSB, ISB, AM and CW modes of operation over the frequency range of 5 to 600 kc with 5 watts output and 1.75 to 33.75 mc with 1 watt output. 100 cycle incremental tuning, with stability and accuracy of 1 part in 10⁸ per day, is featured. FSK and FAX modes are available with an external keyer, such as TMC Model TIS-3.

Audio bandwidth up to 7500 cps for each sideband is provided, flat to ± 1.5 db from 250-7500 cps. Signal to distortion ratio is at least 45 db from full PEP output.

AN/URA-41

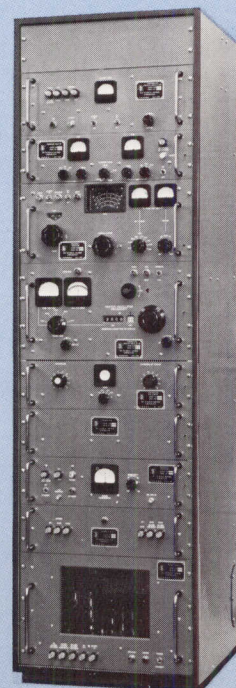

TRANSMITTING ACCESSORY

MULTI-MODE EXCITER

NEW



MODEL MMX- ()

BULLETIN 2039

The MMX- () is all solid state, compact, high quality, multi-mode exciter providing the basis for a whole new generation of TMC transmitters. It will undoubtedly become the multi-purpose workhorse of the industry, surpassing such veterans as the AN/URA-23, AN/URA-28 and AN/URA-30 in commercial and military applications.

The small size, versatility and operational simplicity of this exciter make it especially suitable for transportable applications.

Radio operators will immediately appreciate the simplicity of the ease of operation. Frequencies are determined without any calculation and are displayed clearly in numerical form. No tuning or peaking is required. Installation in a central console of a transmitter station will permit an operator to remotely control the output frequency of a transmitter.

FREQUENCY RANGE: 1.6-31.999 mc. (MHz) in 100 cycle incremental steps. For remote tuning, see OPTIONS/ACCESSORIES. Direct reading. • **MODES OF OPERATION:** CW, AM, SSB (ISB, FSK-FAX, optional extra). • **OUTPUT POWER:** 1. Continuously adjustable to 1 watt, CW, FSK, FAX. 2. Continuously adjustable to 250 mw. PEP, SSB, ISB, AM. • **OUTPUT IMPEDANCE:** 50 ohms nominal. • **FREQUENCY STABILITY:** 1 part in 10^6 per day for ambient temperature change of 15° C. within the range of $0-50^{\circ}$ C. 1 part in 10^7 or 10^8 per day (optional extra). 1 part in 10^9 per day (optional with external standard). • **INSTALLATION DATA:** Size: $5\frac{1}{4}$ " H. x 19 " W. x 18 " D. • **PRIMARY POWER:** 115/230 v. \pm 10% 50/60 cps. (Hz), single phase, 60 watts.

SOLID STATE VARIABLE OSCILLATOR



NEW

MODEL VOX-7

BULLETIN 2040

The VOX-7 is a compact, solid state, ultra stable, incrementally tuned oscillator. This unit has been designed for transmitter/RF exciter frequency control and the control of HFO, IFO and BFO oscillators of receiving systems in either diversity or single receiver operation.

The primary output of the VOX-7 is displayed numerically from 1.6 to 32 MHz in tuning increments down to 10 Hz. Tuning can be accomplished by remote control, as an optional extra.

The very high stability of this variable oscillator (upwards of 1 part in 10^8 per day) makes it extremely suitable as a laboratory RF signal generator. High reliability and compactness is assured by employing the advantages of solid state construction.

FREQUENCY RANGE: 1.6-31.999,990 mc (MHz). Direct reading. Remote control of the frequency selection knobs is available (see OPTIONS/ACCESSORIES.) Remote control of frequency selection either hard wire or teletype signal format. • **INCREMENTAL TUNING:** 10 MHz, 1 MHz, 100 kHz, 10 kHz, 100 Hz, and 10 Hz. • **OUTPUT IMPEDANCE:** 50 ohms. • **OUTPUT LEVEL:** Variable up to 1 watt.

LOW FREQUENCY MULTI-MODE EXCITER

NEW



MODEL LFE- ()

BULLETIN 2042

The LFE, a versatile, convenient and reliable Low Frequency Exciter will surpass the AN/URA-41 as a replacement for the master oscillator of conventional transmitters. As an option, this unit can also be used for Frequency Shift Keying and will replace the C-2749 URT in commercial and military applications.

Transportable applications are ideal as this exciter employs the advantages of small size and operational simplicity.

Frequencies in the 30 KHz to 2 MHz range can be determined without any calculation and are displayed on the front panel in numerical form. Tuning is in 10 cycle incremental steps and can be remotely controlled as an optional extra.

FREQUENCY RANGE: 30 kHz-1.999,990 mc (MHz) in 10 cycle incremental steps. For remote tuning, see OPTIONS/ACCESSORIES. Direct reading • **MODES OF OPERATION:** CW, AM, SSB, FSK, FAX (ISB, optional extra.) • **OUTPUT POWER:** 1. Continuously adjustable to 1 watt, CW, FSK, FAX. 2. Continuously adjustable to 250 mw. PEP, SSB, ISB, AM. • **OUTPUT IMPEDANCE:** 50 ohms nominal. • **FREQUENCY STABILITY:** 1 part in 10^6 per day for ambient temperature change of 15° C. within the range of $0-50^{\circ}$ C. 1 part in 10^7 or 10^8 per day (optional extra). 1 part in 10^9 per day (optional with external standard). • **FREQUENCY CONTROL:** All frequency determining elements referenced to a built-in 1 mc (MHz) source. • **METERING:** Built in multi-meter allows monitor of critical circuits and RF output. • **TUNING:** Digital frequency selection by front panel control. • **INSTALLATION DATA:** Size: $5\frac{1}{4}$ " H. x 19 " W. x 18 " D. Weight: Approximately 30 lbs. • **PRIMARY POWER:** 115/230 v. \pm 10% 50/60 cps. (Hz), single phase, 60 watts.

AND EXCITER EQUIPMENT

SIDEBAND GENERATORS

TMC Models SBG-1 and SBG-2 are stabilized general purpose exciter systems adjustable to 320,000 frequencies over the frequency range of 1.75 to 33.75 megacycles in 100 cycle steps, with stability of 1 part in 10^8 per day. Models SBG-1 and SBG-2 provide SSB, ISB, AM, and CW operating modes. A phase detector comparison circuit with direct meter indication allows the built-in standard to be compared to a master or station standard.

AUDIO RESPONSE: SBG-1 Crystal lattice filter flat within ± 1.5 db, 250 to 7500 cps. SBG-2 Crystal lattice filter flat within ± 1.5 db, 250 to 3300 cps. • **FREQUENCY RANGE:** 1.75 to 33.75 megacycles in 100 cps steps. • **FREQUENCY CONTROL:** All frequency determining elements referenced to a built-in 1 mc source. • **FREQUENCY STABILITY:** 1 part in 10^8 per day. • **OUTPUT POWER:** Continuously adjustable from zero to 1 watt PEP. • **OUTPUT IMPEDENCE:** 72 ohms nominal. • **CARRIER SUPPRESSION:** At least 55 db down from PEP level.

**MODEL
SBG-2**
BULLETIN 2010

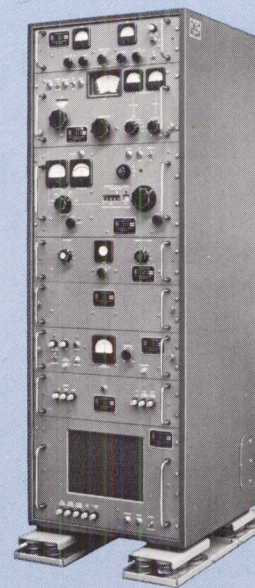

AN/URA-30 A

SIDEBAND GENERATORS

- 2 to 32 mcs
- 100 cycle tuning
- Digital frequency presentation
- Four independent audio channels or symmetrical filter
- SSB, ISB, AM, AME, CW, FSK, FAX, Pulse and Phase modes
- VOX and Anti-VOX
- TechniMatic* tuning available

**MODEL
SBG-3**
BULLETIN 2012

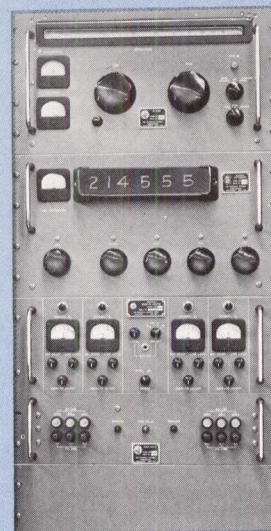

*Trademark applied for

SPEECH PROCESSING UNIT

The TMC Speech Processing Unit, Model SPU-2, is a completely transistorized volume compressed, peak clipped and filtered audio amplifier for use with a voice modulated AM or SSB transmitter to provide additional overall system efficiency. Clinical articulation tests have indicated 50% to 65% improvement of intelligibility under adverse signal to noise conditions.

The SPU-2 combines compression and clipping with a special pre-emphasis circuit. Pre-emphasis commences at 200 cycles and has been peaked at approximately 2500 cycles with a 6 db per octave slope through the audio passband to provide uniform power density in the transmitted intelligence.

Provision is made in the SPU to disable the clipper circuits when the unit is used as a constant level amplifier with a receiver. When used in the output of a receiver in conjunction with a hybrid junction, the SPU-2 will provide constant output to minimize circuit ringing.

**MODEL
SPU-2**
BULLETIN 2026



AM-3905/URT

TRANSMITTING ACCESSORY

MODEL PAL-350

BULLETIN 2002

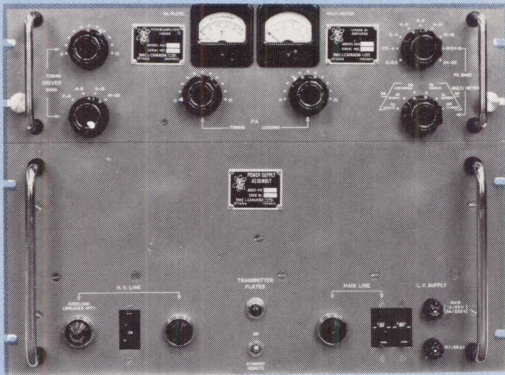

AM-2867/GRT-9

LINEAR POWER AMPLIFIER

TMC Linear Power Amplifier Model PAL-350C (OCD and Canadian DOT certification) will accept SSB, ISB, AM, CW, MCW, FSK and FAX excitation over the frequency range of 2 to 32 mc and will provide 350 watts PEP output for sideband transmission and 175 watts average power output for conventional and FSK modes of operation.

Particular attention has been given to the suppression of distortion products (-40 DB at full PEP), amplifier stability (automatic load and drive control incorporated), and power supply hum content (-50 DB).

Full interlock, overload and fuse protection have been provided for the safety of operating personnel and protection of the equipment. A filtered forced air blower system is included as an integral part of the PAL-350. The PAL-350 occupies only 14" of panel space in a standard 19" cabinet.

SIDEBAND EXCITER

The TMC Models SBE-8 and SBE-9 and SBE-10 are universal sideband exciters providing at least 250 MW PEP output for use with any appropriate RF linear amplifier. SBE units provide excitation from 2 to 32 megacycles in SSB, ISB, and AM modes, with carrier insertion adjustable from 0 to -55 db. Conventional CW operation is also available.

Frequency control for all modes of operation available with SBE is accomplished by means of oven controlled crystals, with the added advantage of external VFO insertion. Sideband selection is accomplished by specially designed filters. Second harmonic suppression on two tone test is at least 40 db down, and all others are at least 50 db down from full output. Spurious (as defined by CCIR) is at least 60 db down for the SBE-3 and SBE-4, and at least 55 db down for the SBE-2.

• **AUDIO BANDPASS:** SBE-8 Flat within ± 1.5 db 250-3040 cps. SBE-9 Flat within ± 1.5 db 250-7500 cps. SBE-10 Flat within ± 1.5 db 250-6080 cps

MODEL SBE BULLETIN 2008



AN/URA-23A

AN/URA-28

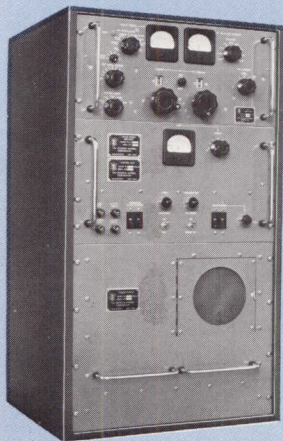

MODEL PAL-1KB

BULLETIN 2003A

AN/URA-36B

LINEAR POWER AMPLIFIER

The TMC Model PAL-1KB Linear Power Amplifier is conservatively rated to deliver 1000 watts PEP output when either SSB or ISB excitation is applied or 1000 watts average power output with an AM, CW, MCW, FSK or FAX input. The PAL-1KB covers the frequency range from 2 to 32 mc and features:

- Front panel bandswitching and tuning
- A ceramic type tube for high efficiency
- Automatic load and drive control to improve linearity and suppress unwanted transmission products (-40 DB from full PEP)
- Metering of all critical circuits
- Filtered forced air cooling and complete interlock and overload protection.

AND EXCITER EQUIPMENT

VARIABLE FREQUENCY OSCILLATOR

TMC Model VOX-5 is a direct reading, precision, frequency device designed to control the oscillators of a diversity receiver or of a transmitter exciter. This oscillator is also used as a secondary frequency standard.

Model VOX provides a continuously variable output over the range 2 to 64 mc, with direct reading calibration over the basic oscillator range with better than 0.002% long term stability. Frequency calibration is provided by means of an oven controlled 100 Kc crystal oscillator with visual zero beat indication.

FREQUENCY RANGE: 2 to 64 megacycles. • **OUTPUT LEVEL:** 2 watts, 2 to 4 mc; 0.5 watts, 4 to 64 mc. • **STABILITY:** 20 cycles per megacycle for any fixed temperature from 0 to 50 degrees C. • **RESET-ABILITY:** Better than 20 parts per million to a previously calibrated frequency. • **ADDITIONAL FEATURES:** 1. Crystal BFO for receiver control. 2. Crystal IFO for receiver control. 3. Three HFO crystal positions. **INPUT POWER:** 115/230 volts, 50-60 cycles, single phase.

MODEL VOX-5

BULLETIN 2018

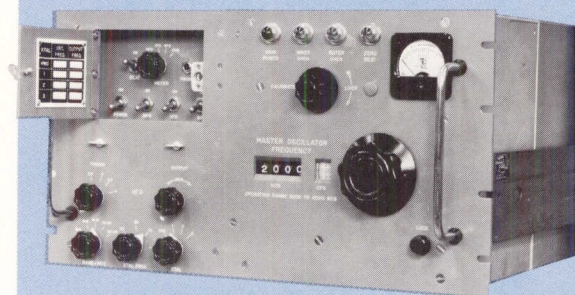

O-330B/FR

MODEL PMO

BULLETIN 2007



O-459A/URT

PRECISION MASTER OSCILLATOR

The Model PMO Portable Master Oscillator and Heterodyne Frequency Meter is a highly stable, precision, direct reading device used as a transmitter exciter, frequency meter or receiver calibrator. It provides output over the range 2 to 8 mcs and is directly calibrated by means of a counter-dial system over the range of 2 to 4 mcs. An oven controlled 100 Kc oscillator provides visual calibration of the unit.

FREQUENCY RANGE: 2 to 8 mcs. • **OUTPUT:** At least 2 watts adjustable • **STABILITY:** Better than 20 parts per million for a 30°C change in ambient. • **CALIBRATION:** Direct reading in cycles, 2 to 4 mcs. • **READABILITY, RESETABILITY:** 20 parts per million to a previously calibrated frequency • **CALIBRATION:** Against a crystal controlled 100 kc oscillator with visual indication.

FREQUENCY SHIFT EXCITER

The Model XFK Frequency Shift Exciter is a high stability radio frequency oscillator which replaces the crystal oscillator in the transmitter and provides the mark and space pulses necessary for the transmission of teletypewriter, narrow band FM telephone, or facsimile intelligence. The XFK features two precision temperature controlled ovens providing the high stability required for unattended operation.

FREQUENCY RANGE: 1 to 6.9 mcs. • **FREQUENCY SHIFT:** Linear to 1000 cycles. • **OUTPUT:** 3 watts adjustable into 70 ohms. • **CONTROLS:** Directly calibrated in frequency. • **FREQUENCY CONTROL:** 3 crystal positions and one external oscillator position. • **KEYING SPEED:** 1000 wpm. • **STABILITY:** 10 cycles for an ambient change of 50 degrees C.

MODEL XFK-2

BULLETIN 2020

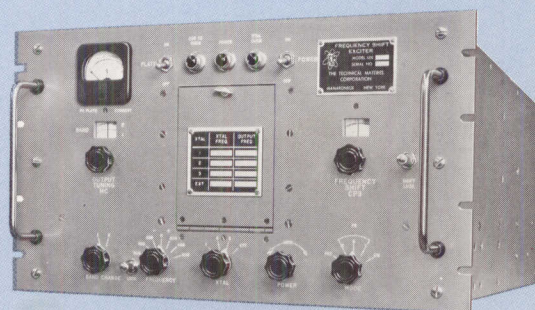

C-2749A/URT

TRANSMITTING ACCESSORY

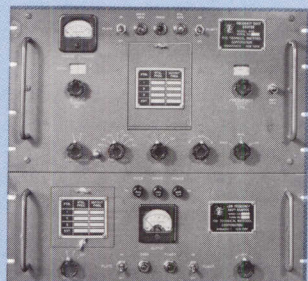

MODEL XFL-2

**BULLETIN
2021**

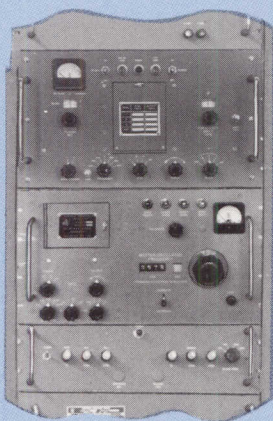

**MODEL FXS
AN/URA-33**

**BULLETIN
2027**

NEW

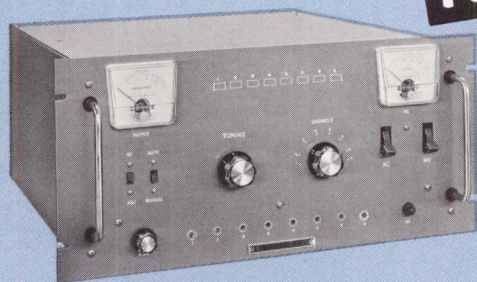

MODEL LPA-2 BULLETIN 2041



MODEL TIS-3

BULLETIN 2025



TH-39B/UGT

FREQUENCY SHIFT EXCITER SYSTEM

The XFL-2 Frequency Shift Exciter System combines TMC Models LFA Low Frequency Adapter and XFK Frequency Shift Exciter, to provide FSK mode of operation over the frequency ranges of 5-600 kcs and 1 to 6.9 Mcs. Providing 5 watt push-pull output with less than 5% distortion, the XFL-2 has excellent linearity and stability. Keys up to 1000 WPM. The LFA-4 Low Frequency Shift Adapter may be obtained separately for use with existing keyers to provide low frequency operation.

FREQUENCY SHIFT EXCITER SYSTEM

TMC Model FXS Frequency Exciter System provides CW, FSK and FAX modes of operation over the frequency range of 2 to 64 megacycles. Model FXS is particularly suited to the application of these modes of operation with a linear amplifier. Variable frequency control is available as well as fixed crystal operation. Carrier shift of up to 1000 cycles, either linear with applied voltage, or independent of applied voltage amplitude variation is featured. Carrier center frequency and shift control adjustments can be made simply and rapidly as these two adjustments are independent. Adjustment of carrier center frequency does not affect shift amplitude and vice versa.

1 KW LINEAR POWER AMPLIFIER

FREQUENCY RANGE: 1.6 to 23 MHz.

The LPA-2 is a 1,000 watt linear power amplifier ideal for ship-shore-ship services, extended telephone applications, pipeline service and contingency transportable requirements.

The LPA-2 combined with the TTR-20, or any other exciter providing 50 watts average input will provide full output over the frequency range of 1.6 to 23 MHz.

Featured in the amplifier is a safety interlock system to protect the operator from shock.

The LPA-2 may be switched manually to any one of eight pre-determined channels by a channel select control on the front panel or automatic channel selection may be slaved to any suitable exciter, such as the TMC TTR-20.

TONE INTELLIGENCE UNIT

Model TIS-3 fulfills a requirement for FSK and FAX modes of operation when used with any sideband transmitter where shift of the transmitter carrier would defeat the inherent stability of the equipment. Model TIS-3 provides a simple approach to this problem by means of frequency shifted audio tones with the total spread of the signal being indicated on a digital counter dial for FSK operation (with up to 1000 cycle shift). 1200 cycle linear shift for facsimile operation (depending upon the amplitude of the applied FAX DC controlled voltage) is also provided.

Not limited to single sideband transmitters, TIS-3 can be used on telephone lines or microwave links. Selectable center frequencies for FSK and FAX modes of operation are available, as well as a 1000 cycle note for CW keying. The unit mounts in 5¼" of a standard 19" panel and has received wide acceptance from both military and commercial users.

AND EXCITER EQUIPMENT

ANTENNA TUNING SYSTEM

Model ATS-2 is a complete antenna tuning system that can be fitted to any transmitter with 50 or 70 ohm output to couple 1000 watts of RF energy with 100% modulation into any suitable antenna wherever the VSWR does not exceed 4 to 1. Whenever the VSWR of 4 to 1 is exceeded, or when power ratings are exceeded in the tune or operate position, a safety overload opens the transmitter interlock circuit. The tuner is housed in a fiberglass weather-proof case which contains a desiccant. Presence of moisture in the tuner is indicated by a meter on the front panel of the unit.

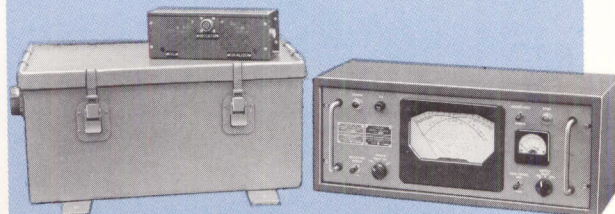

MODEL ATS-2 **BULLETIN 2001**
AN/URA-27A AN/URA-34A

VSWR INDICATOR

Model SWR-1K provides accurate indication of voltage standing wave ratio from 2 to 30 mcs at 1000 watts average power with VSWR up to 5 to 1, and greater VSWR with reduced RF power. Unique design of the instrument permits simultaneous indications of forward and reflected RF power for direct VSWR readings. Directional couplers are available for 50 or 70 ohm unbalanced transmission systems.

The unit may be mounted in an optional cabinet or your standard 19" rack.

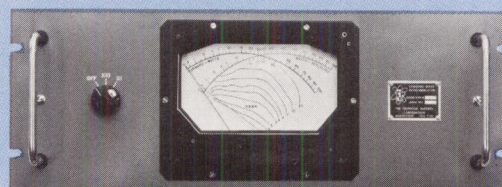

MODEL SWR-1K **BULLETIN 2014**
IM-166/URT

VSWR INDICATOR

TMC Model SWR-3000 Standing Wave Ratio Indicator Systems provides accurate visual readings of forward power, reflected power, and VSWR. Any 2-32 mc transmission up to 3000 watts PEP operating into a 50 or 70 ohm transmission line with VSWR as high as 5:1 can be accommodated by the SWR-3000 with negligible insertion loss.

For transmitting stations, electronic plants, laboratory analysis and "hams", the SWR-3000 models RM, PM, CU, or JB1 meet any customer requirement to indicate transmitter efficiency immediately.

Model SWR-10K and Model SWR-60K are also available for 10 KW average power and 60 KW average power applications.

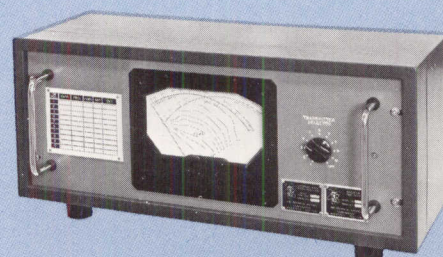

MODEL SWR-3000 **BULLETIN 2015**
MODEL SWR-60K **BULLETIN 2029**
MODEL SWR-10K **BULLETIN 2031**

GENERAL PURPOSE RECEIVERS

COMPLETELY SOLID STATE COMMUNICATIONS RECEIVER

NEW



MODEL GPR-10
BULLETIN 3012

- **EXCEPTIONAL DYNAMIC RANGE**
- **AM, SSB, CW.**
(ISB AVAILABLE)
- **CONTINUOUS ONE KNOB TUNING 0.5MHz-32.0MHz**

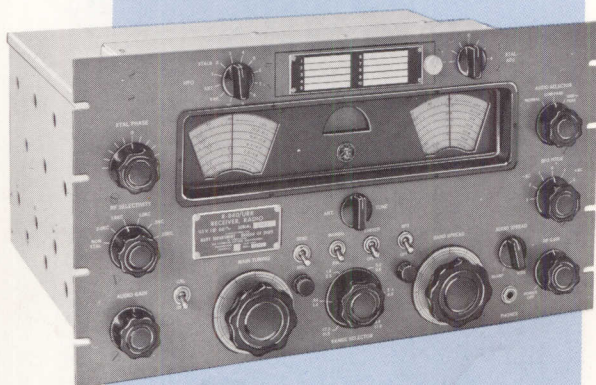

MODEL GRP-90RXDS
BULLETIN 3005
MODEL GPR-91RXDS
BULLETIN 3009

- Incorporates Maximum Overall Selectivity over the Entire Frequency Range.
- Most Advanced Design Techniques with Pre-planned Plug-in Flexibility.
- Planned for Building-Block Expansion as Customer Needs require.
- Integral Preselector to overcome Strong Interference.

The Model GPR-10 receiver was designed by The Technical Materiel Corporation simultaneously with the development of the latest U.S. military remote control receiver system. This design effort was dedicated to the objective of creating an entirely new, practical and economical receiver oriented to the commercial, export and maritime markets, in addition to meeting those military requirements not involving the more expensive and esoteric frills.

The variation of components incorporated to meet the anticipated requirements of a wide variety of customers was deliberately planned on a plug-in basis with appropriate front panel modifications. This flexibility eliminates the major portion of the time, expense and effort otherwise required in modifying equipments in the field in accordance with a customer's increasing needs over the years. The unit is designed for synthesis, and doubtless those who have in the past striven to synthesize an already purchased receiver will much appreciate this concept.

Even a remote control capability has been designed, although not otherwise mentioned in this bulletin, in order that such may be economically and quickly provided should a customer find he has a relatively large volume requirement for such capabilities.

Consequently the GPR-10 is by far the leading receiver for all professional applications worldwide, incorporating as it does advanced design techniques not employed in any other commercial receiver — and at an economical price!

This completely solid state receiver also offers a very wide variety of special features including counter readout of the frequency to which the receiver is tuned, AFC, ISB and Independent AGC control for the ISB channels. An IF Monitor output of 12 KHz bandwidth is provided for the purpose of processing four channel ISB reception.

A selective front end prevents adjacent channel interference and allows operation of the receiver in fields of very high signal strength which precludes the usual overloading and blocking of the receiver. Note the overall selectivity of the receiver at 250 KHz IF output of 12 KHz bandwidth. In addition, the RF AGC threshold (independent of the final IF AGC's) is at an antenna signal of approximately 100 microvolts, which is in the neighborhood of 60 db above the noise level of the receiver.

Full explanation of these and the many other features incorporated in the GPR-10 are contained in TMC Sales Bulletin.

The 130 db dynamic operating range from 10 db (S+N)/N threshold provides less than 3 db variation of audio output in SSB operation with 3 KHz bandwidth. The time constants may be designated by the customer to meet own requirements, on a special order basis.

COMMUNICATIONS RECEIVER

Models GPR-90RXDS and GPR-91RXDS are general purpose communications receivers that provide for the reception of SSB, AM, MCW, CW, FSK and FAX operation over the frequency range of .54 to 31.5 mcs. Ten built-in crystal positions provide high stability to match that of typical voice SSB transmitters.

Model GPR-91RXD with its 15 kc bandpass capability provides facilities for ISB reception. Both receivers, in conjunction with appropriate adapters, such as TMC Models MSR and SBS, can cope with almost any mode of communication used today. This series of receivers features very selective high sensitivity input circuits with low intermodulation, delayed AGC, variable IF audio selectivity and accurate dial calibration. Both receivers are 10½" high and 19" wide.

FIXED TUNED HF-VLF RECEIVERS

SOLID STATE "STRIP" RECEIVER

This solid state "strip" receiver occupies but 1¾" of standard 19" panel space and requires only 15 watts of power to operate it. Front panel plug-in RF modules cover the frequency range of 2.0-32 mcs in octaves of 2-3, 3-4, 4-6, 6-8, 8-12, 12-16, 16-24, 24-32 in two basic modules with replaceable frequency determining elements. 0 dbm audio power is available for a 600 ohm line and 500 milliwatts audio power for a 4 ohm speaker. The low heat that is generated by these units and complete front panel control provide a receiver that is readily adaptable to rack mounting for multiple reception requirements.

Reception capabilities include ISB, LSB, USB, CW, AM, AME, AFAX and AFSK modes.

SOLID STATE FIXED TUNED RECEIVER

Model SMR-5, Solid State SSB Receiver, features rapid selection of any one of eight preset channels for ISB, USB, LSB, AM, AME, CW, MCW, FSK and FAX reception in the 2 to 32 mc range.

Eight separate tuned RF heads, provide selection of any one of 8 operating frequencies plus upper and lower sideband. A front panel control permits fine tuning of received signal.

FREQUENCY RANGE: 2-32 mcs on eight pre-tuned channels in the ranges of 2-3, 3-4, 4-6, 6-8, 8-12, 12-16, 16-24, 24-32 in two basic modules with replaceable frequency determining elements.

• **FREQUENCY STABILITY:** 1 part in 10⁶ per day (oven controlled crystals). • **SENSITIVITY:** 1.0 microvolt for 15 db signal to noise ratio. • **AGC:** With 100 db change in input signal from 1 microvolt, the output will not vary more than + 6 db. • **IF:** 300 to 3300 cps mechanical filter for SSB, 6 KCS symmetrical about the carrier for AM. • **POWER:** 115/230v AC, ±10% 50/60 cps single phase. 12v DC; 8 watts (less ovens).

SOLID STATE VLF RECEIVER

TMC Model VLRA-1, Very Low Frequency Receiver, is a compact, completely transistorized ten channel receiver providing exceptional stability, sensitivity, selectivity and reliability for the reception of continuous carrier, CW and FSK signals over the frequency range of 10 kc to 100 kcs. The tuning modules are designed to provide optimum reception under very weak signal conditions.

Simplicity of front panel design provides complete signal control and operational ease in selection of desired RF channel. An attractive cabinet that can be fitted with shipboard shock mounts is provided.

FREQUENCY RANGE: 10 to 100 kc. • **MODES OF RECEPTION:** AO and CW. FSK with appropriate converter. • **FREQUENCY STABILITY:** Error will not exceed .001% of operating frequency. • **FREQUENCY CONTROL:** Crystal controlled. • **INPUT IMPEDANCE:** 50 ohms nominal. • **SENSITIVITY:** A 0.1 microvolt signal impressed across 50 ohms at the input of the receiver will produce a minimum of 10 db signal + noise to noise ratio at 100 cps bandwidth. • **AGC:** No greater than ± 3 db change in output for an 80 db change in input. • **AUDIO RESPONSE:** Constant within ± 1.5 db from 100 to 2500 cps. • **POWER:** 115/230v AC ± 10%, 47 to 400 cps cycles, single phase.

NEW

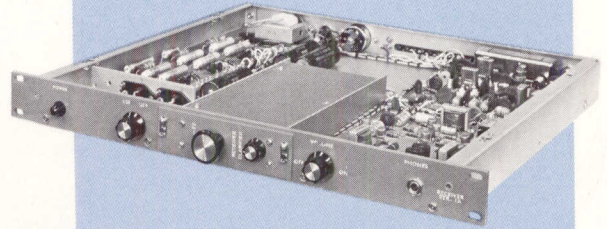

MODEL STR-5

BULLETIN 3014

NEW

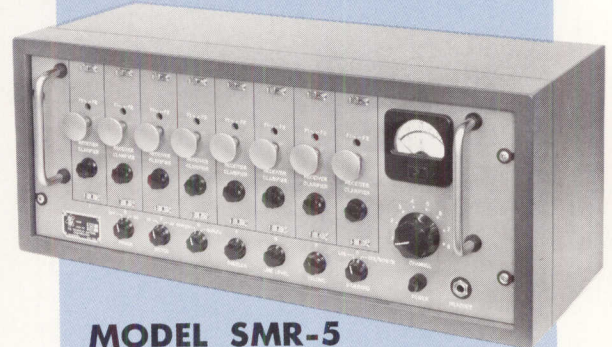

MODEL SMR-5

BULLETIN 3010



MODEL VLRA-1

BULLETIN 3008A

SOLID STATE RECEIVERS

SOLID STATE VLF AND LF/MF RECEIVERS



MODEL VLRC-1
BULLETIN 3017



MODEL VLRB-1
BULLETIN 3015

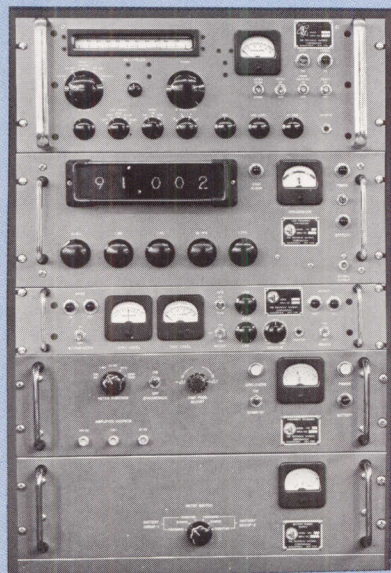

MODEL LRR-1
BULLETIN 3011

In today's era of atomic weapons, frequencies at the lower portion of the RF spectrum (below 600 kcs) appear to be least affected by atomic detonation and are therefore very important for communication purposes. These frequencies have proven to be very reliable radio communications media during periods of high sunspot activity.

To fulfill communication requirements in the VLF and LF/MF frequency ranges, The Technical Materiel Corporation has developed two continuously tuned and optimized solid state receivers, Model VLRC-1 for 10 to 40 kc coverage and Model VLRB-1 for 30 to 600 kc coverage. Each of these receivers occupies only 7" of standard rack space and provides reception capabilities of AM, AME, CW, FSK and FAX signals. Reception of some of these modes, particularly in the VLF range, will depend on the capability of the transmission system. IF and RF outputs are available to facilitate the use of ancillary devices for ISB and SSB reception and for use with frequency standard comparison systems.

(See Model LRR-1)

A synthesizer that is locked to a 1 mc frequency standard of 1 part in 10^9 per day is available as an option at extra cost.

SENSITIVITY: 0.3 microvolt for 15 db signal plus noise to noise ratio. • **BAND PASS:** 0.1, 0.5 and 2 kc at 3 db (8 kc for VLRB-1). • **POWER:** 115/215/230 vac \pm 10% 47 to 400 cps.

SOLID STATE LF/MF RECEIVER

An entirely new solid state LF/MF receiver, Model LRR-1, provides CW, MCW, AM, AM equivalent, SSB, ISB, FAX and FSK reception from 30 to 600 kcs. The unit is synthesized in one cycle steps from 30 to 100 kcs and 10 cycle steps to 600 kcs. 1" illuminated NIXIE lights display the frequency to which the receiver is tuned. One part in 10^9 stability is assured by a built-in frequency standard. A battery supply, maintained at full charge during normal operation, automatically powers the system during power failures.

FREQUENCY RANGE: 30 to 600 kcs continuous in 5 bands. • **RECEPTION MODES:** CW, FSK, FAX, SSB from 30 to 600 kc. AM and ISB from 55 to 600 kc. • **SENSITIVITY:** 0.1 microvolt for 15 db signal + noise to noise at 500 cycle bandwidth. • **STABILITY:** 1 part in 10^9 . • **AFC:** 25 db suppression at 1 microvolt front end, system will remain synchronized within \pm 300 cps at 30 kc. • **AGC:** No greater than 3 db change for 100 db input variation. • **POWER:** Solid state 115/230v, AC \pm 10%, 47-400 cycles, 60 watts. • **SIZE & WEIGHT:** 31" \times 22" \times 20", 90 lbs.

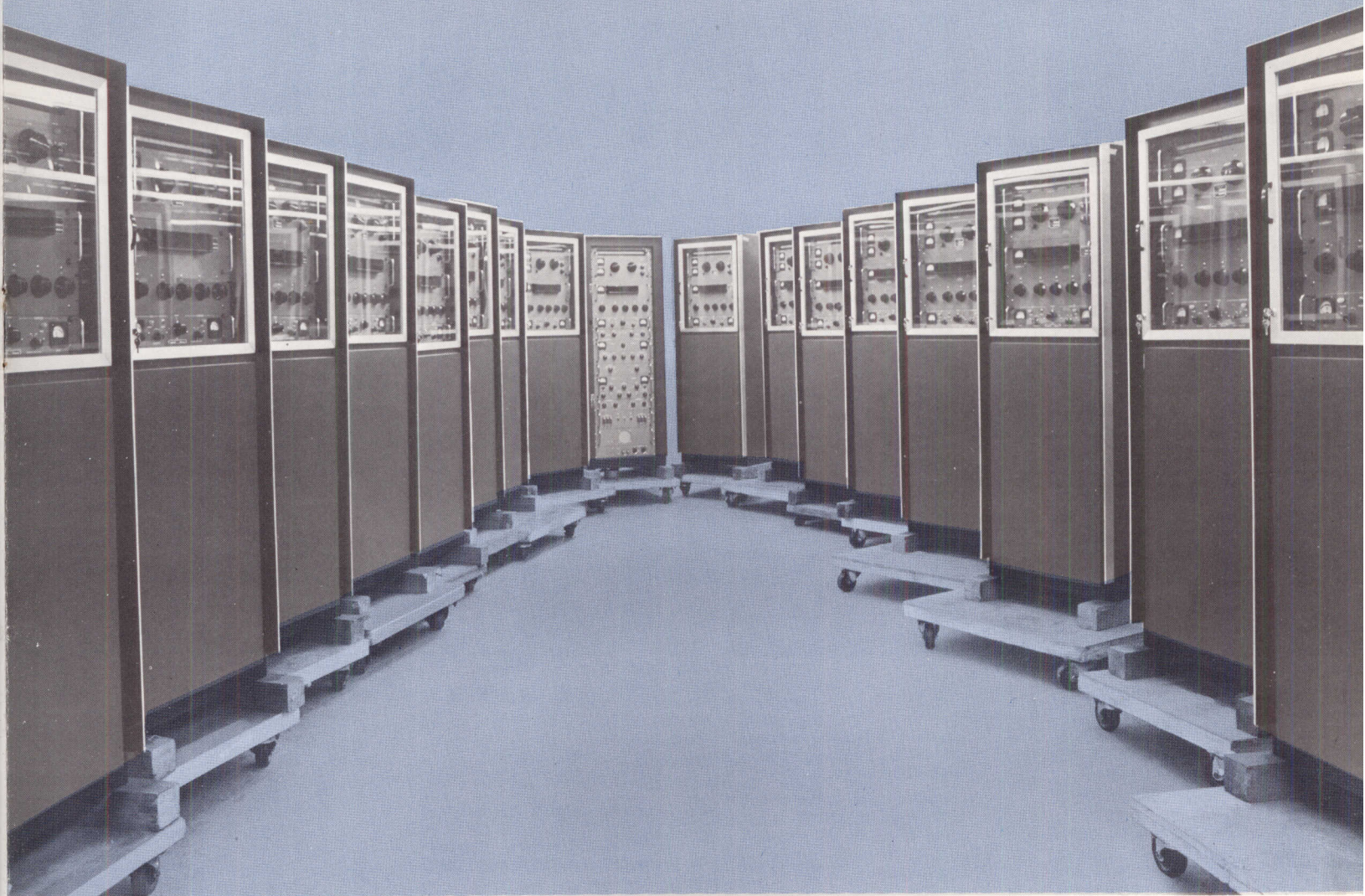

THE MODULAR **DDR-5** FAMILY OF RECEIVERS

Within this series of service-accepted modular receivers, you will find combinations that provide the following capabilities:

- 2-32 mcs coverage, continuous or fixed tuning
- 1 part 10^8 stability
- 100 cycle tuning
- Direct reading frequency
- Better than 1 microvolt sensitivity
- Noise figure 6 db or better.
- 150 db dynamic range
- CW, AM, AME, SSB, ISB, FSK, FAX, Pulse and Phase reception
- Four channel ISB†
- On DCA approved list
- High speed remote control by means of the Techni-Matic* tuning system.

AN/FRR-60(v)

The independent AGC system (MSG()-1) featured in many of the DDR-5 Series receivers provides.

- Commercial quality telephone and telegraph circuits
- Four independent 3 kc voice channels demultiplexed at the IF level
- Each voice channel with its own AGC produces usable uniform audio outputs

†For more information on the Four Channel Independent AGC System, please request BULLETIN 4004A.

*Trademark applied for.

DDR-5K

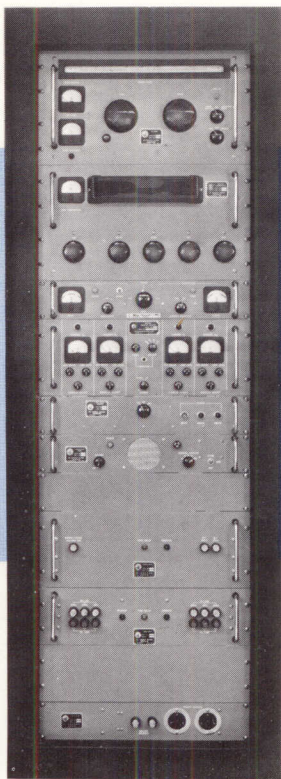

- Four channel ISB reception
- 60 db AGC action within each demultiplexed IF channel
- AFC for pilot carrier reception

Model DDR-5K couples a continuous tuned sensitive RF amplifier, a high stability synthesizer and 4 channel independent AGC to provide a receiver capable of meeting the exacting requirements of multiplexed ISB reception.

The independent AGC action with each demultiplexed IF channel provides uniform output from all four 3 kc voice channels. By this means, the power level of the transmitted signal can be adjusted to emphasize the more important 3 kc channels without requiring constant attention to the audio output level of the receiver.

Size: 69" h x 24 1/4" w x 30" d.

Weight: 750 lbs.

Power Consumption: 1100 watts.

DDR-5B

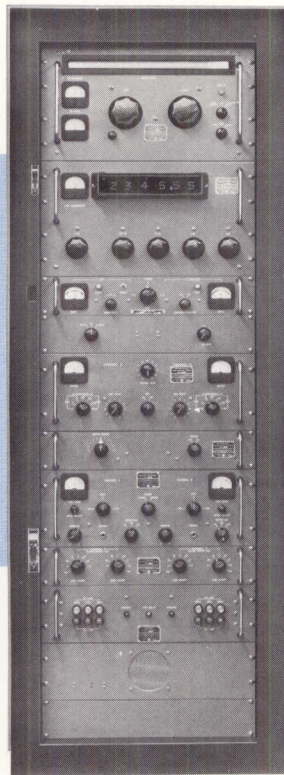

The DDR-5B receiver is designed to fulfill a wide variety of exact-receiver requirements.

- AFC for pilot carrier reception
- Separate IF and AF units
- Up to 7.5 kc ISB reception
- SSB, CW, MCW, AM, AM equivalent, FSK and FAX

A wide selection of IF filters, both symmetrical and sideband, as well as IF and audio filters, provide a receiver ideally suited to cope with almost any type of signal.

Demultiplexing of ISB signals can be accomplished at the audio level by means of Model RMX-2, Dual Demultiplexer.

Size: 69" h x 24 1/4" w x 30" d

Weight: 650 lbs.

Power Consumption: 750 watts

DDRR-5B

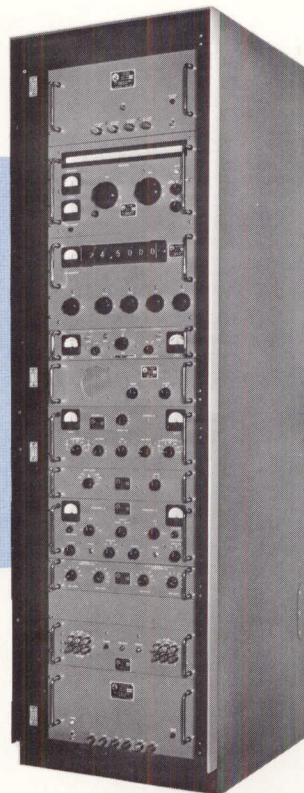

TECHNIMATIC TUNING

- 8 preset channels.
- Noise figure better than 4 db
- Four channel ISB reception
- 60 db AGC action within each demultiplexed IF channel
- AFC for pilot carrier reception

The DDRR-5B is a Technimatic version of the DDR-5B. This receiver is compatible with the world wide system of remote control discussed on page 24.

Size: 69" h x 24 1/4" w x 30" d

Weight: 700 lbs.

Power Consumption: 1150 watts

DDR-551

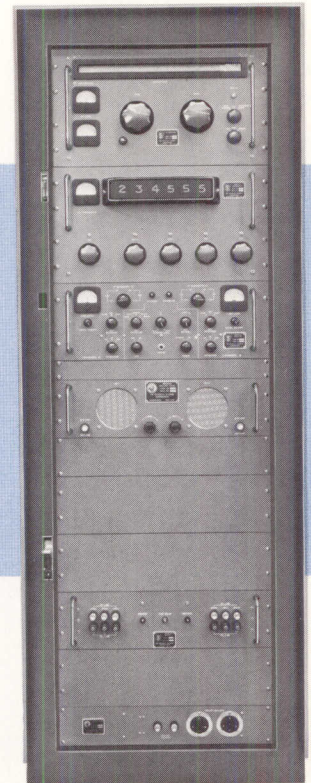

- SSB, ISB, AM, AME, FSK, FAX, MCW, Pulse & Phase modes for

- Point-to-Point
- Ground-to-Air
- Shore-to-Ship

- Continuous tuned 100 cycle steps
- 1 part 10⁸ stability
- Illuminated digital frequency display
- 150 db dynamic range
- 1 microvolt for 15 db $\frac{S + N}{N}$

The input dynamic range of this receiver has been carefully correlated with optimum sensitivity, image rejection, unwanted radiation, cross-talk, spurious response and stability to accept a wide variation of input voltage without degrading the receiver's technical characteristics. All of the modules within this receiver have been approved for service use. This receiver meets or exceeds MIL-SPEC for temperature, humidity and radiated or conducted interference.

DDR-5A

- CW, AM, AM equivalent, SSB, ISB, FSK and FAX modes
- AFC for pilot carrier reception
- Separate IF and AF units
- IF notch filters
- Audio filters

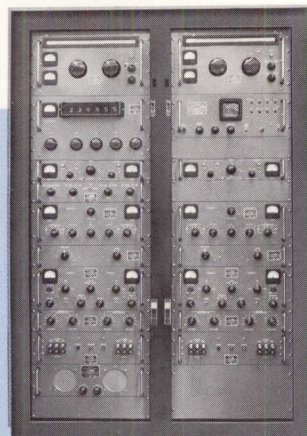

This first of the DDR-5 Series has been field proven on critical military communications circuits. Since the installation of these receivers, circuit outages have been drastically reduced.

Space diversity reception of sideband and conventional modes is made possible by a wide selection of symmetrical and sideband IF filters.

Scope presentation of the IF signals as well as tunable IF notch and audio filters provides the versatility required to cope with varied circuit requirements.

Size: 69" h x 47" w x 30" d.

Weight: 1100 lbs.

Power Consumption: 1500 watts

DDR-51

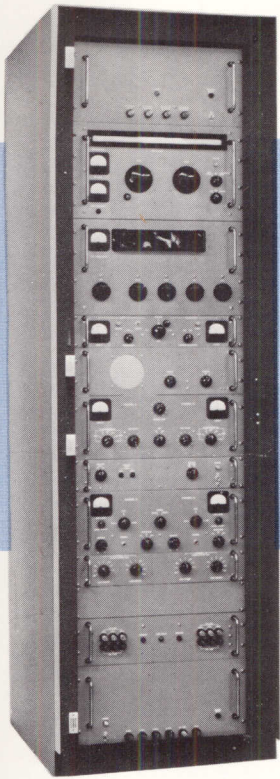

This receiver ideally replaces and upgrades the AN/FRR-41.

- Four channel ISB reception
- 60 db AGC action within each demultiplexed IF channel
- CW, SSB, ISB diversity reception
- AFC for pilot carrier reception

This highly stable diversity communications receiver correlates the extreme front end sensitivity and low noise figure of the HFR-1, the high stability of the HFS-1, and the versatility of the four channel IF demultiplexer to provide diversity reception of multiplexed signals. 60 db of independent AGC within each IF channel provides uniform and constant telephone quality audio output from associated audio channels.

Size: 83" h x 24 1/4" w x 30" d

Weight: 1100 lbs.

Power Consumption: 2000 watts.

- CW, AM, AM equivalent, SSB, ISB, FSK and FAX modes
- AFC for pilot carrier reception
- Separate IF and AF units
- IF notch filters
- Audio filters

Size: 69" h x 47" w x 30" d.

Weight: 1150 lbs.

Power Consumption: 1500 watts.

DDR-5M

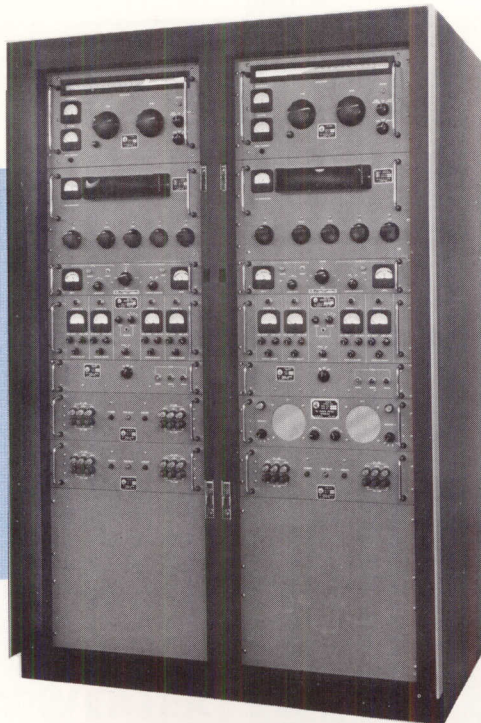

AVAILABLE WITH TECHNIMATIC TUNING as DDRR-5M

- 8 preset channels
- Noise figure better than 4 db.
- Four channel ISB reception.
- 60 db AGC action within each demultiplexed IF channel
- AFC for pilot carrier reception
- CW, SSB, ISB diversity reception
- Dual synthesizers 1 x 10⁶ stability

This receiver, in a dual cabinet, provides space diversity, frequency diversity, or each section of the receiver can be used as an independent receiver with the stability provided by the included synthesizer. Four channel independent AGC reception provides 60 db of AGC action within each IF channel, giving telephone quality audio output at a constant and usable level.

Size: 69" h x 47" w x 30" d.

Weight: 1300 lbs.

Power Consumption: 2200 watts.

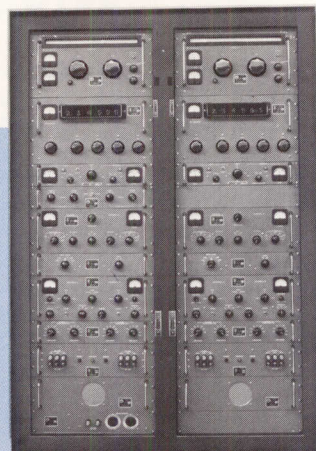

DDR-5BR

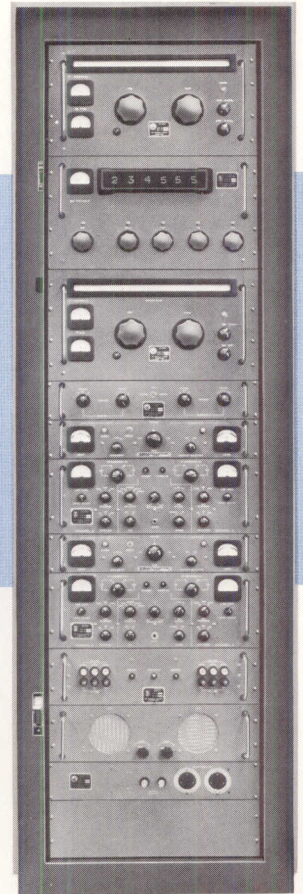

TECHNIMATIC TUNING

- CW, AM, AME, SSB, ISB, FSK, FAX, Pulse and Phase
- AFC for pilot carrier reception
- Up to 7.5 kc for ISB reception
- Separate IF and AF units
- IF notch filters
- Audio filters

One of the DDR-5 series of TechniMatic receivers, this unit is completely remote controlled including analog control of the RF gain and the BFO for remote operation in the CW mode. This receiver can be placed on any frequency and in any operating mode by means of standard CCITT or ASCII message format.

Size: 83" h x 24 1/4" w x 30" d.

Weight: 1100 lbs.

Power Consumption: 1500 watts.

DDR-5C

This receiver incorporates all of the features of the DDR-5A but has the added advantage of being able to operate in space and frequency diversity as well as operating either section of the receiver on entirely separate circuits. This receiver has been used on critical military circuits and has been instrumental in reducing circuit outage time beyond design specifications.

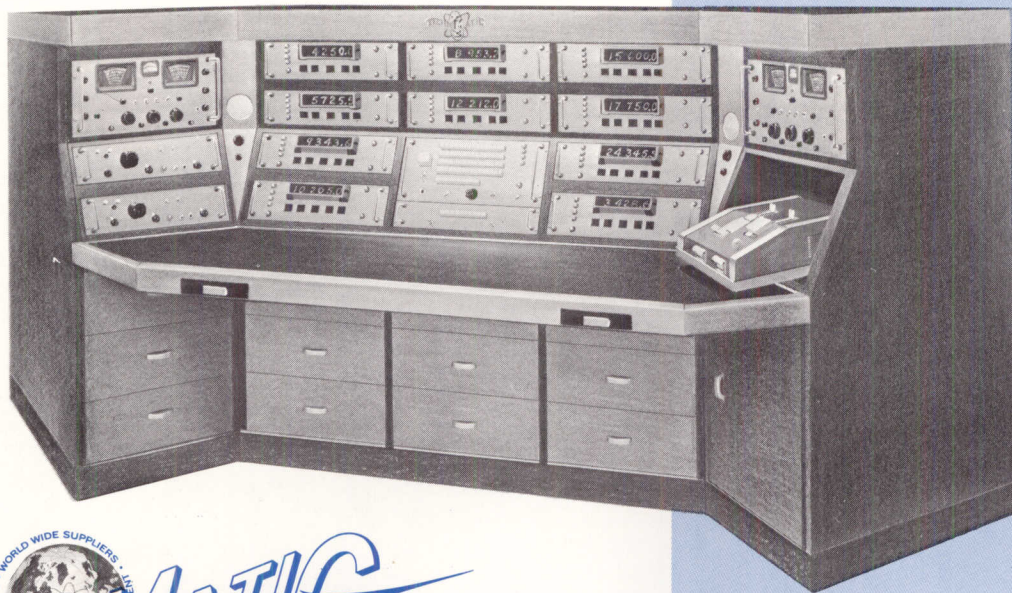

WORLD WIDE SUPPLIERS ASSOCIATION
OF ELECTRONICS

TECHNIMATIC

TUNING

THE WORLD-WIDE SYSTEM OF REMOTE CONTROLLED COMMUNICATIONS

This console permits an operator to tune both transmitters and receivers remotely to frequencies and various modes of operation on an automatic and pre-programmed basis by means of pre-cut tapes, cards, memory systems or manual selection and provides a readback of information to the operator showing him that the selected tuning functions have, in fact, been performed.

The system is unique in that manual override is provided at the remote site; however, any change in the positioning of the controls at the remote site would automatically be indicated on the remote controller's console. Tuning functions of transmitters and receivers, including the selection of frequency, audio and RF levels, sideband selection are controlled at this console. Readback indication of the frequency to which the remote units have been tuned to is presented by 1" illuminated digital display at the operator's console. Other tuning functions are displayed on illuminated indicators.

ALL THE MODULAR FAMILY OF
DDR-5 RECEIVERS
 SHOWN ON THE PRECEDING PAGES
 CAN BE FACTORY OR FIELD EQUIPPED
 FOR REMOTE CONTROL

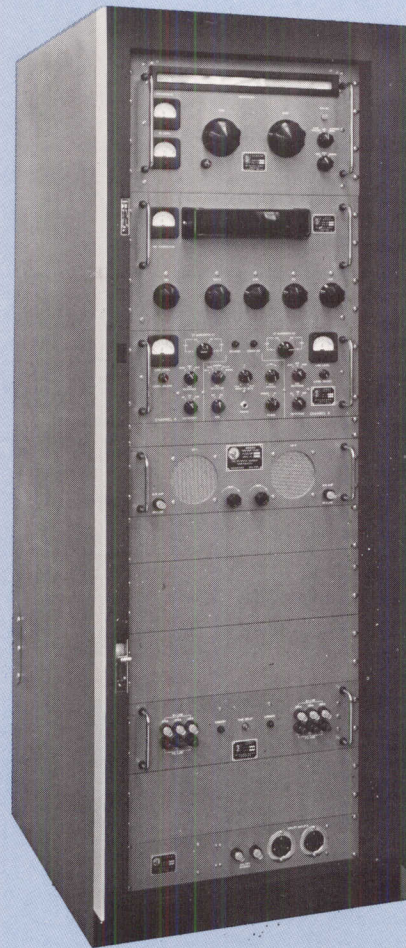

RECEIVER ACCESSORIES

FOUR CHANNEL INDEPENDENT AGC SYSTEM

The Four Channel Independent AGC System, TMC Model MSG, was designed to fulfill the ever-increasing requirements of rapid speaker-to-listener commercial telephone quality voice communications via long distance radio circuits.

The increased stability of sideband transmitters and receivers has made possible the use of audio translation equipment, thus providing four 3 kc channels for use on a single transmission circuit. By this means, four distinctly separate circuits, which may be used for voice, multiple tone telegraph, data, etc., are transmitted by a single transmitter.

The quality of each of the four 3 kc channels must be maintained at commercial quality, if military command and control personnel are to recognize the voices on the other end of the circuit. This factor can only be accomplished by uniform gain and response controlled **independently within each 3 kc channel.**

SIDE BAND CONVERTER

Models SBC Sideband Converters are IF type of receiving adapters which will allow the use of many conventional communication receivers in receiving SSB and ISB transmissions. A built-in electronic AFC control that will follow a suppressed carrier of up to -25 db with a capture range of 50 cycles and a drift capability of ± 750 cps will overcome the inherent drift in either the transmitter or the receiver to allow multichannel reception.

Model SBC-9 and SBC-10 are identical except the SBC-10 contains two voice frequency demultiplexers, TMC Model RMX-2, which makes this unit a modern electronic replacement for the military CV-157/TD-98 combination. Models SBC provide AGC control on independent sideband operation that is derived either from Channel A, from Channel B, from the carrier, or from Channel A and B combined. Model SBC accepts an IF input frequency of 455 kilocycles; however, other IF frequencies can be provided upon special order. A large selection of IF filters are featured. The over-all accuracy of either Model SBC is such that audio tones provided to the receiving terminal equipment will have a residual error of less than 1 cycle from that of the transmitted tones.

SIDE BAND ADAPTER

Models MSR are IF type sideband adapters that provide single sideband reception with many conventional receivers and greatly enhance the operation of these receivers. Provisions for the selection of upper or lower sideband, as well as the capability of demodulating AM, CW, MCW, and FSK signals are additional design features of these adapters. Simultaneous reception of upper or lower sideband information is possible by the use of two MSRs, with a single receiver. The combination of a specially designed bandpass filter circuit and a frequency bandsread oscillator provides sharp discrimination between desired and undesired signals. All Model MSR features crystal and manually controlled oscillators, and provides oven controlled crystals for stability better than ± 1 cycle for a 20° C. change in ambient.

MSR-9 455 kc IF (oven controlled crystal)

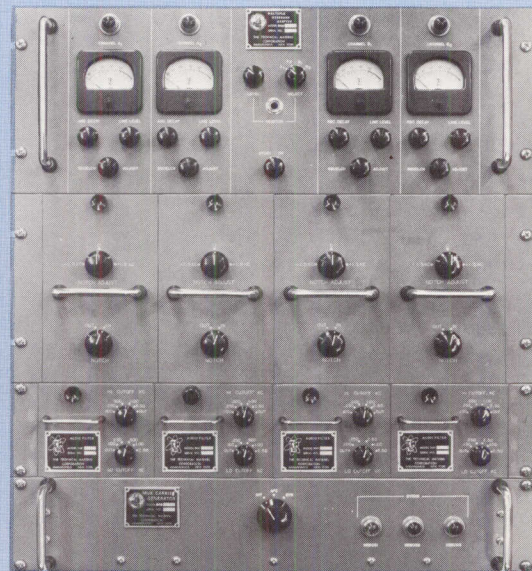

MODEL MSG-()
BULLETIN 4004A



MODEL SBC-9
BULLETIN 4003

AN/URA-59
CV-1288/UR
C-4071/UR



CV-591A/URR
CV-657A/URR

CV-1722/URR
CV-1758/URR

MODEL MSR
BULLETIN 4001

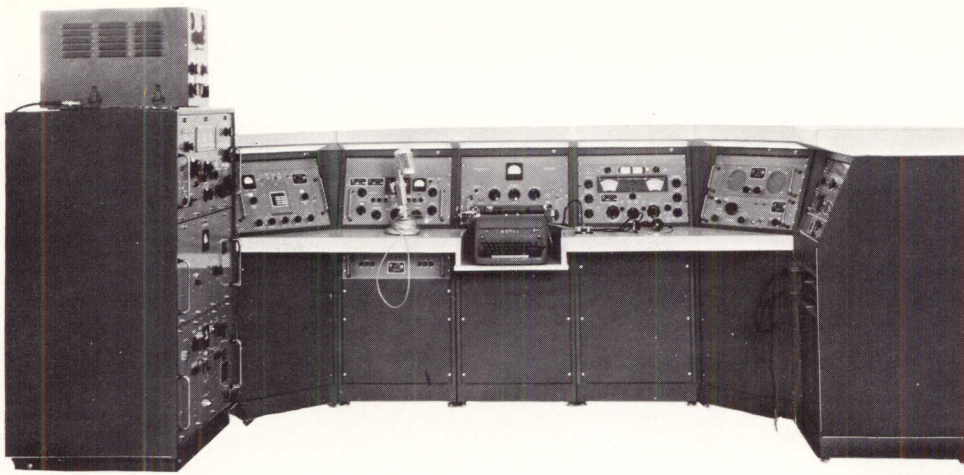

MODEL CON OPERATING CONSOLES

PRESENTLY IN SERVICE THROUGHOUT THE WORLD

CON Operating Consoles with modular "add a unit" type enclosures offer maximum operating efficiency and flexibility by centralizing the control of military or commercial SSB, AM, FM or TV broadcasting, computer operation, data handling, telemetering, laboratory analysis, airport control tower applications, in fixed, mobile or shipboard installations.

Any specified customer option is easily constructed using the standard 19" rack mounted assemblies in these units to form "L", "U" and many other configurations. 16 gauge reinforced steel with formica top covers ensure durability.

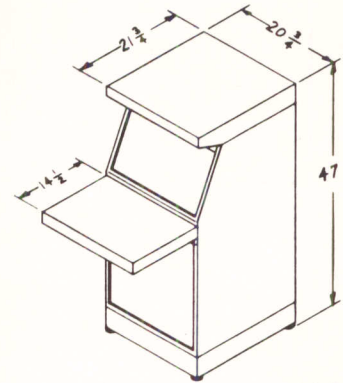

CON-1-A-H

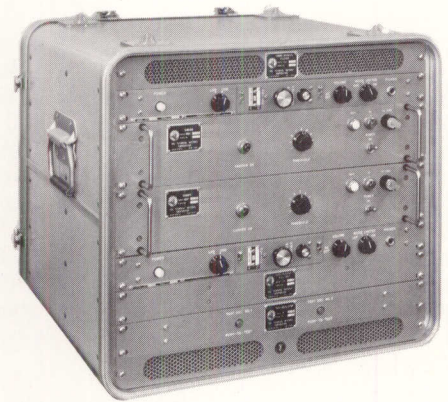
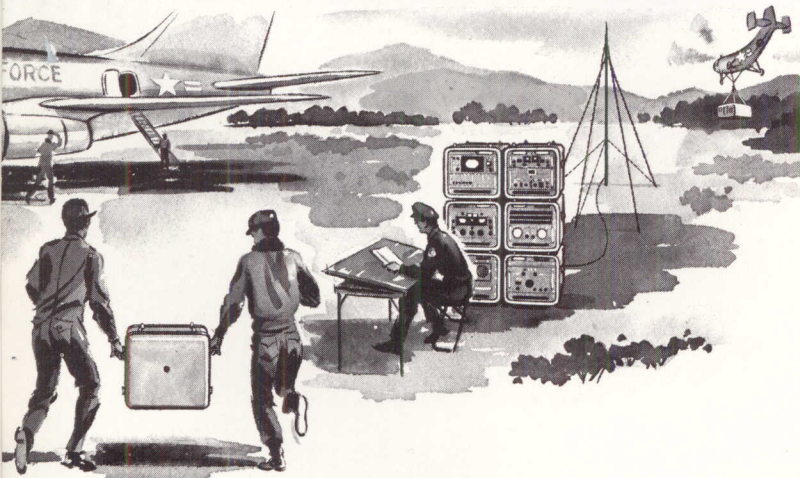
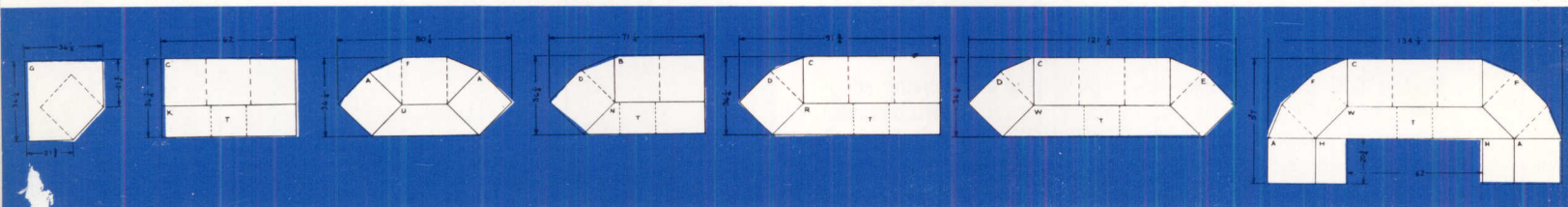

MODEL TOC TB 9005

TRANSIT/OPERATING CASE

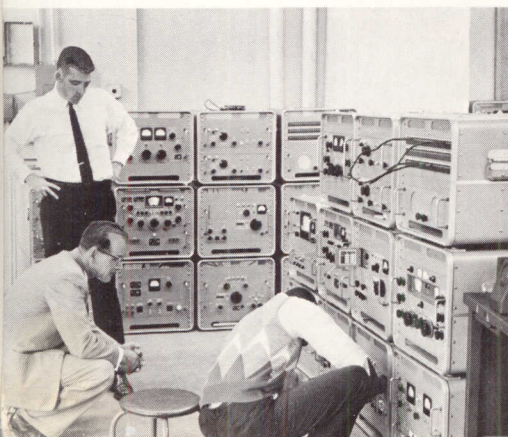
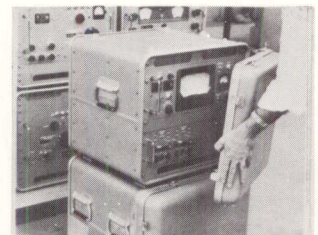

Models TOC, Transit/Operating Cases, are ideally suited for rapid mobility and operation of equipment for contingency communications. Pressure relief valves are provided to neutralize high altitude transportation conditions and special interlocking feet allow stacking for operation in confined areas. Both front and rear covers are instantly removable.

RECEIVER ACCESSORIES

FREQUENCY SHIFT CONVERTER AND FILTER PANEL

Model CFA accepts frequency shift keying audio tones from two receivers operated in diversity, combines these two signals, uses the better of the two to operate a standard teletype battery loop at speeds up to 450 wpm.

A multi-purpose panel meter facilitates precise tuning, compensation for bias, plus monitoring of discriminator outputs, operating voltages and loop current and voltage.

Special circuitry to eliminate the effects of received carrier drift up to 1500 cycles, bias correction control, threshold control to minimize effects of noise, and automatic "mark-hold" to place the output circuitry in a "mark" condition during signal fadeouts and a test switch to place the unit in a mark, space or line condition are design features of this unit.

Model SFP-2, when used in conjunction with CFA, provides two filters centered on the mark and space frequency to greatly enhance teletypewriter reception under adverse or weak signal conditions.



MODEL SFP-2
MODEL CFA-2
BULLETIN 4008

CV-763/URR

STABILIZED CRYSTAL OSCILLATOR

TMC Model TRX-1, Stabilized Crystal Oscillator, is a self-contained unit featuring oven control crystals whose outputs can be used for:

1. Operation of receivers either singly or in diversity
2. Translation frequencies for sideband exciters
3. Master oscillator injection frequencies for transmitters

In diversity operation with two receivers, selection of all injection frequencies for stabilized operation of the receivers is accomplished on the front panel of the TRX-1.

STABILITY: 1 part in 10^6 per day. **CRYSTALS:** Ten HFO crystals — CR-27/U; one IFO crystal — CR-47/U or CR-47A/U; two BFO crystals — CR-47/U or CR-47A/U. • **OUTPUT:** 50 ohms nominal. • **OUTPUT LEVEL:** 1 volt rms. • **POWER:** Solid state; 115/230v, single phase, 50/60 cycles, approximately 100 watts, with oven on.

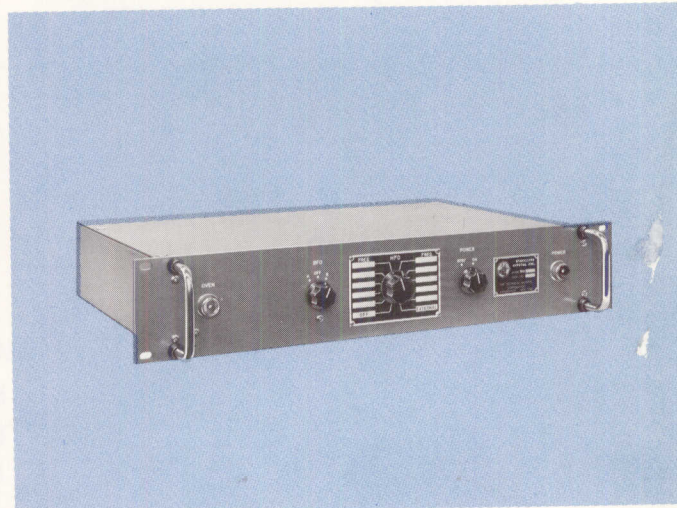

MODEL TRX-1
BULLETIN 4006

DIVERSITY VISUAL MONITOR

Visual monitor unit, Model DVM, permits accurate and simple visual analysis for receiver tuning. Dynamic band occupancy studies on a 3" calibrated oscilloscope screen gives a positive identification of interfering signals when used with either a single or a diversity receiver. Analysis of a received signal or any interference being experienced provides the operator with a very useful tool for proper reception of any type of signal. Model DVM-2 accepts a 500 kc input, DVM-3 accepts a 455 kc input, and model DVM-4 a 1.75 mc input. Other frequency inputs are available on request. Sweep of the DVM allows analysis of signals from .075 to 1 kc either side of the center frequency of the IF strip. The unit occupies 7" of a standard 19" cabinet.

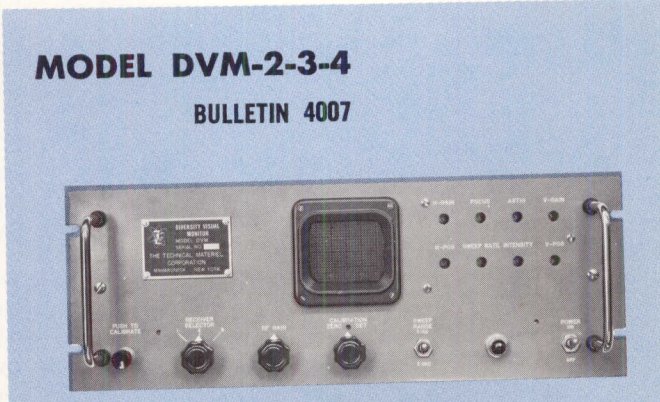

MODEL DVM-2-3-4
BULLETIN 4007

IP-641/URR

TD-410/UGC
TD-411/UGC

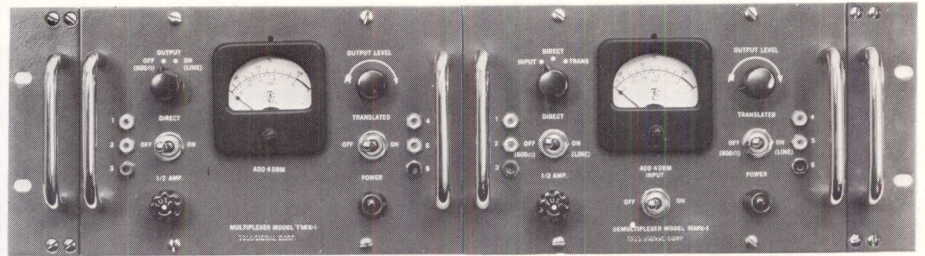

BULLETIN 5002

TMC Model TMX-1 and RMX-1 are voice frequency multiplexers and demultiplexers which provide a simple means of combining two 3 Kc voice channels for transmission in 6 Kc bandpass and of separating two 3 Kc voice channels on the receive side. Any form of intelligence that can be placed in the 375 to 3025 cycle voice bandpass can be transmitted or multiplexed by means of the TMX-1. With two TMX-1 and two RMX-1 it is possible to provide four voice frequency channels within 12 Kc of a standard sideband transmission system. The TMX-1 and RMX-1 will meet CCIR specifications of 250 cycles to 6000 cycles for overall transmission bandpass, if desired.

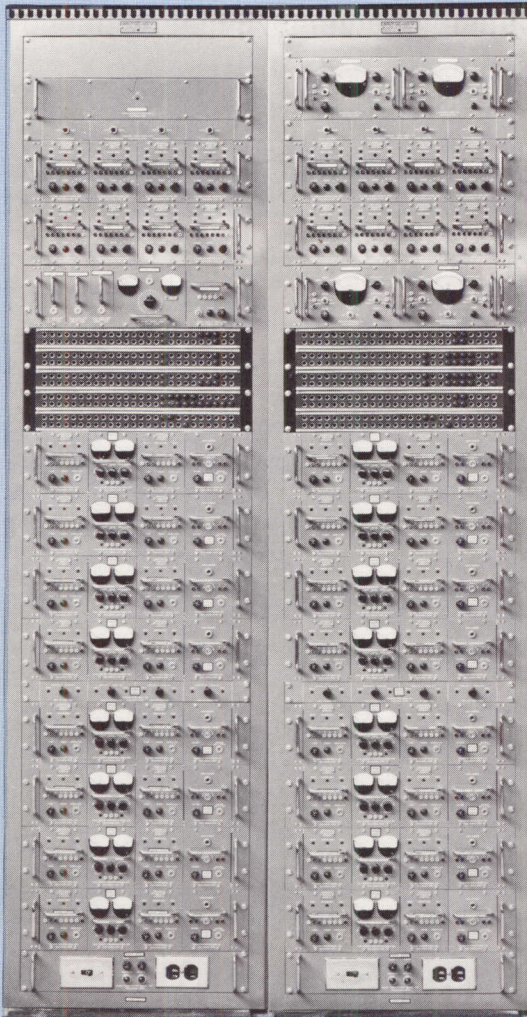

Model TTS-3 is a completely transistorized tone telegraph transmission system providing 16 send and 16 receive teletypewriter channels at speeds up to 100 wpm (75 bauds). Space diversity reception is provided with constant comparison and electronic selection of the better of 2 receive signals. All channels of the TTS telegraph system are compensated for no greater than 250 microsecond variation in keying time from any one channel to any other channel within the system. Model TTS-3 can be provided in channel spacing of 170, 340, 120, 240 cps, or customer selection. Other systems also offered within this family include the TTS-1, TTS-2, TTS-4, TTS-5 and TTS-6.

TERMINAL EQUIPMENT

(Designed and manufactured for TMC by the Tele-Signal Corporation)

MODEL TTS-3

- BULLETIN TB 5001
- BULLETIN TB 5003
- BULLETIN TB 5004

MODEL TTM-2

BULLETIN 5009

TMC Model TTM-2 is a completely transistorized and miniaturized tone telegraph system providing up to 16 send and receive teletypewriter or data transmission channels at speeds of up to 100 wpm (75 bauds) in channel spacing of 170, 340, 120 or 240 cycles. Frequency, space or polarization diversity reception facilities are provided with electronic selection of the better of 2 tone channels.

Delay compensation of no greater than 250 microseconds from any 1 channel to any other channel makes this system useful for sequential data keying from computers or any other type of transmission where time differential between channels would be harmful.

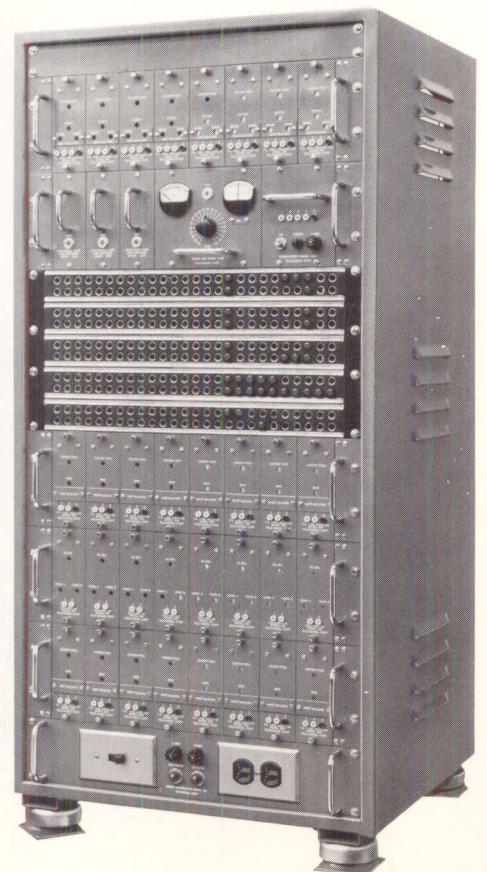

TEST EQUIPMENT

MODEL PTE-4

RF SPECTRUM ANALYZER BULLETIN 6001

Model PTE Spectrum Analyzer is a versatile test instrument designed for RF spectrum analysis. Visual display of RF signals for tuning and aligning single sideband exciters and transmitters provides analysis of inter modulation and distortion products. Manual sweep control allows detailed analysis of any portion of the RF spectrum from 2 to 64 megacycles.

The unit is mounted in an attractive and sturdy 19" relay rack with 4 heavy duty casters for mobility. All controls and test connections are made on the front of the unit. The PTE is supplied with all cables and connections necessary for instant operation. The unit includes a variable, frequency oscillator model VOX for long term stability and a two tone generator which provides 2 AF and 2 RF tones. The frequency of the AF tones are so chosen to permit visual analysis of the 3rd, 5th and 7th order products. The 2 RF tones are provided for a system test of the unit itself. Sweep widths of a fixed frequency, 150 cycles, 500 cycles, 3.5 Kcs, 7 Kcs, 14 Kc, and continuously variable from 0 to 100 Kc with 5 Kc markers are featured.



MODEL VLFC-1

VLF FREQUENCY STANDARD COMPARISON SYSTEM

BULLETIN 6003

SOLID STATE

Model VLFC-1 utilizes the worldwide highly stable VLF transmissions in the 10 to 100 kc range by providing a very sensitive 10 channel VLF receiver and frequency comparison to this VLF signal to provide 1 part in 10^{11} stability. Built-in doppler correction to compensate for mobile platform use, "fail safe" battery supply and completely solid state construction enhances the application of this system for shipboard use.

Correction of station frequency and time standards is easily accomplished by comparison of the station standard frequency to the known high stability of this system.

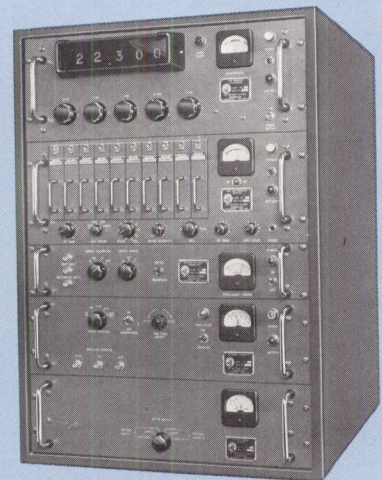

MODEL CSS-2

PRIMARY FREQUENCY STANDARD

BULLETIN 6005

SOLID STATE

Model CSS-2 Primary Frequency Standard is completely transistorized and features highly stable outputs at 10 mc, 1 mc, and 100 kc. Its basic crystal oscillator is contained in a hermetically sealed temperature-stabilized oven with a stability of at least one part in 10^9 for 24 hours. A multi-turn front panel control with 3600 divisions provides total deviation of ± 100 parts in 10^9 . Additionally, Model CSS-2 will accept external DC correction voltage to provide correction of ± 100 parts in 10^9 . The electrical correction circuit can be remoted for central control and correction of more than one of this type of standard.

Features such as low current drain, small size, and ruggedness make it ideal for both mobile and fixed operation. Because of its versatility, it is applicable in many areas where an ultra-stable frequency standard previously could-not be used.



ANTENNAS, COUPLERS

NEW

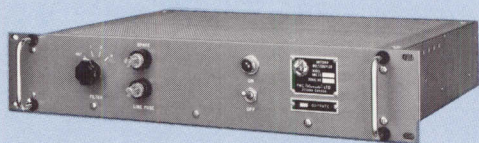

ANTENNA MULTICOUPLER

MODEL AMC-21

SOLID STATE

BULLETIN 8001

Model AMC Solid State Series of Antenna Multicouplers provide broad-banded electronic coupling for multiple receivers to a single antenna over the frequency range 150 kc to 32 mc with a frequency response within ± 1.0 db and an output phase difference between jacks of ± 1 degree. With minor degradation, these are actually useable from 10 kc to 40 mc. High voltage front end protection prevents failure due to high RF voltages. 2.0 Volts RMS; 10% removed in frequency will reduce a 100 uv signal by no more than 3 db. Efficient match with minimum interaction between receivers, and minimum intermodulation and cross modulation are important design features of this unit. Front panel selection of optional filters:

1. Band Pass, 2-32 mc
2. Low Pass, below 2 mc
3. Broadcast Band Stop

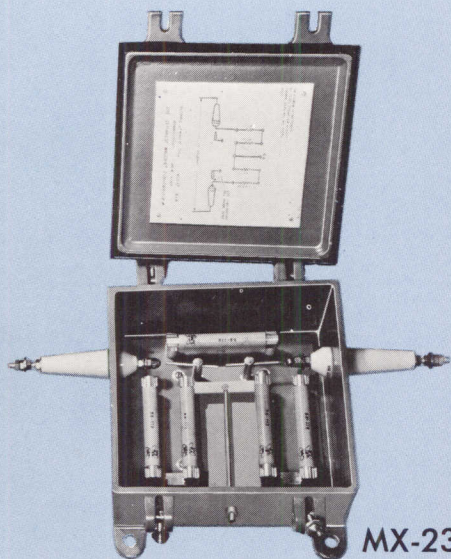

MX-2379A/FRR

MODEL RTB

BULLETIN 8012

RHOMBIC TERMINAL UNIT

Models RTB Rhombic Terminal Units were designed to complement the Models RAC Rhombic Antenna Couplers, and provide rugged and proper terminations for Rhombic or sloping Vee antennas.

The series has recently been redesigned to provide additional resistance coverage and center taps on all units. The Model RTB consists of up to 6 resistors, as required, to provide terminations from 280 to 700 ohms, plus a spare resistor mounted within the case. The resistors are plug-in ferrule type for ease of maintenance and replacement. A built-in lightning arrester prevents the build up of static charges which might damage associated equipment.

MODEL DAC

BULLETIN 8013

DIPOLE ANTENNA COUPLER

The TMC Dipole Antenna Couplers, Models DAC, are impedance matching devices, each providing a balanced connection for the center of a receiving dipole to an unbalanced connection for a coaxial transmission line.

Stainless steel connector rings are provided for the antenna connector and for messenger tie points. The entire unit is contained within a sealed fiberglass reinforced plastic case, and additional strength and weather resistance is provided by "potting" the transformer and connectors in a plastic compound. These units have successfully passed 2000 lb strain test. A built-in lightning arrester prevents the accumulation of static charges which otherwise might injure associated equipment.

FREQUENCY RESPONSE: 50 and 70 ohm unbalanced to up to 600 ohm balanced.

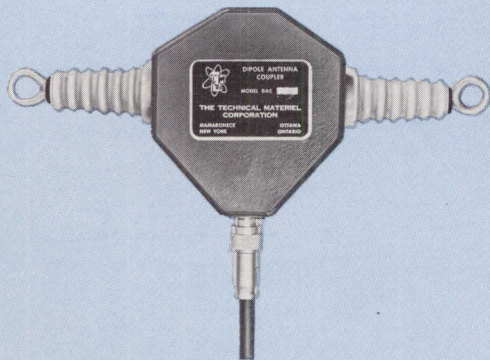

AND DUMMY LOADS

TER SERIES

BULLETIN 8009A

DISSIPATORS/DUMMY LOADS

TMC TER series of RF antenna terminators/dissipators and dummy loads range from 250 watts to 200 kw power dissipating capabilities over the frequency range of DC to 30 mcs. Fiberglass reinforced weatherproof cases and low coefficient of expansion non-inductive glass resistors provide rhombic or sloping Vee termination that may be instantly brought to full rated power in a -40° ambient. Models TER-100K (200 kw PEP) and TER-25K (50 kw PEP) are cooled by filtered forced air and have meters to indicate forward and reflected power to compute VSWR. Locking type of casters for mobility and transmit interlocks for personnel safety are provided.

Operating temperature: -40° to $+75^{\circ}$ ambient.

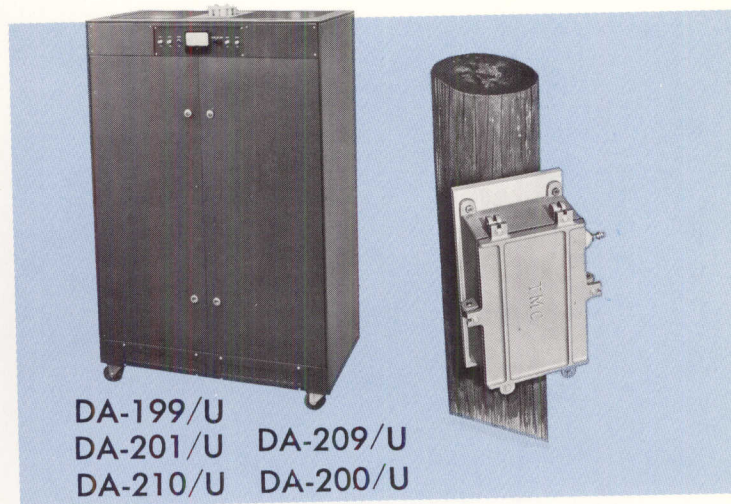

MODEL TRC-5K

BULLETIN 8015A

MODEL TRC-10K

TRANSMITTER ANTENNA COUPLERS

The TRC Series of Broadband Antenna Couplers provide impedance matching between various types of transmitting antenna systems (Rhombic, Sloping-Vee, etc.) and transmitter output impedances. The units are housed in weatherproof cases, fitted with lightning protection, and require no maintenance.

Models TRC allow maximum transfer of RF energy by means of Broadband RF transformers that have power handling capabilities from 250 watts to 40 kw PEP and frequency responses from 2 to 32 megacycles. Use of these units at transmitter sites allows flexibility in antenna patching.

These TRC baluns are completely bilateral devices that will accept either a 600 ohm balanced input and couple it to a 50 or 70 ohm unbalanced output or couple an unbalanced 50 to 70 ohm input to a 600 ohm balanced output without affecting any of the specified characteristics of the equipment.

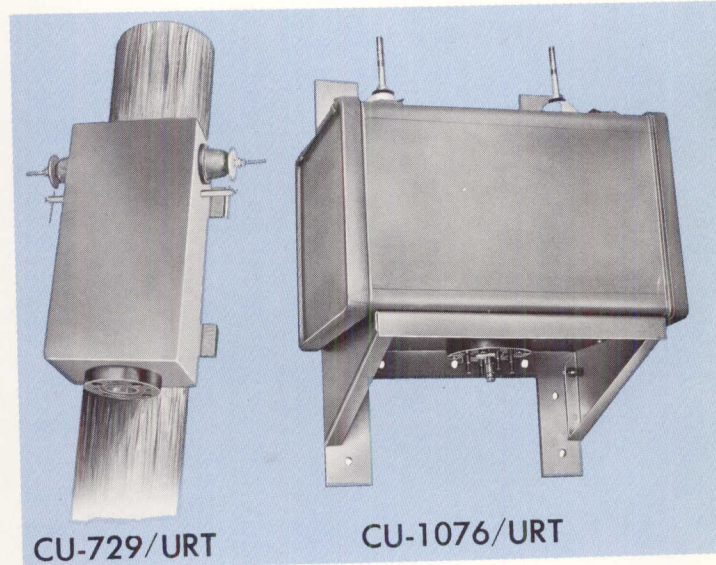

MODEL VRA

BULLETIN 8004

VERTICAL RECEIVING ANTENNA

Vertical Receiving Antennas, Models VRA, are omni-directional whip antenna systems which contain broadband impedance matching transformers to couple 70 ohm output RF emergency to whip antennas.

Models VRA-5 and VRA-8, designed to cover 200 to 800 kcs; VRA-6 and VRA-9, 2-30 mcs; VRA-7 and VRA-10, 2-15 mcs. VRA-5, 6, 7 use stainless steel whips whereas VRA-8, 9, 10 use fiberglass whips.

Used for LF, MF and HF beacon and receiver monitoring, the VRA's are encased in cast aluminum waterproof cases that are easily attached to a wall, roof, pole or vehicle for direct connection to a receiver coaxial input.





TMC

Interior view of a radio transmitter station installation using TMC 10 KW Synthesized transmitters.

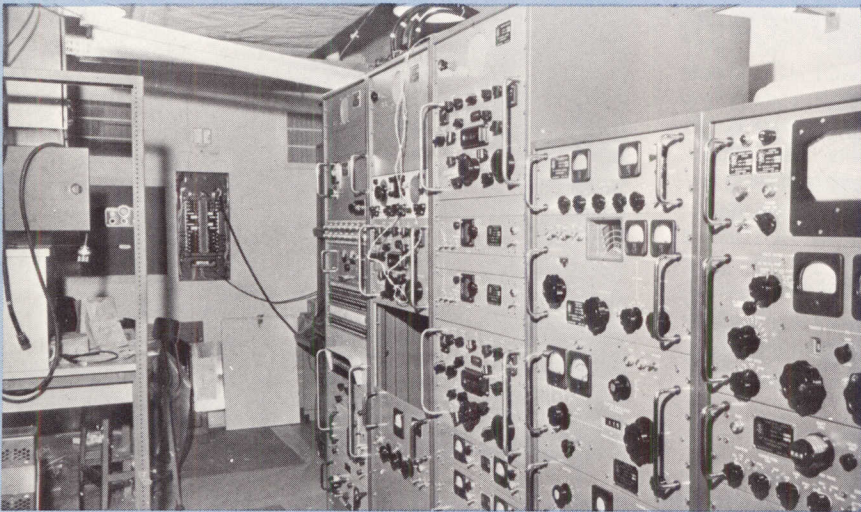

Interior of AN/MSC-42 Transmit/Receive Control Van.

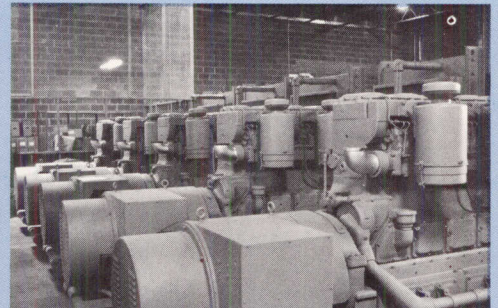

The units shown above, a product of TMC Power Distribution, are part of a massive power complex to be installed in the Middle East. Some of the generators in this complex provide as much as 750,000 watts of power each.



TMC section of R. J. Tilbury Ltd. display, Nairobi Radio and Electronics Show.

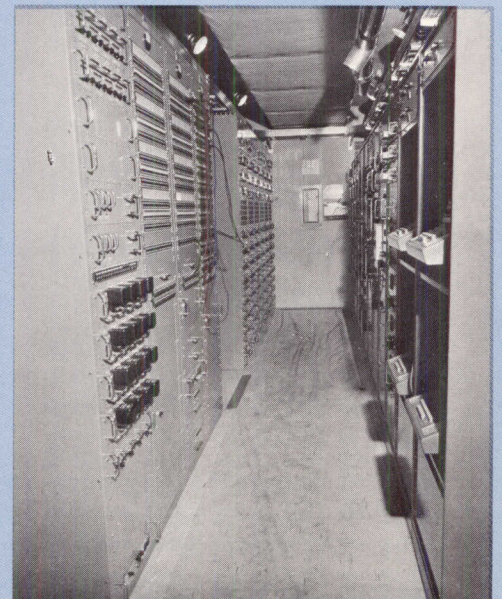

AN/MSC-42 Receiving Center showing tone terminal equipment on the left, receivers and monitor teletypes on the right.

A radio frequency antenna distribution system completely engineered and assembled by TMC Canada, and using our new solid state antenna multicouplers and RF patching facilities. This system provides complete distribution capabilities for one of the largest Canadian military receiving installations.

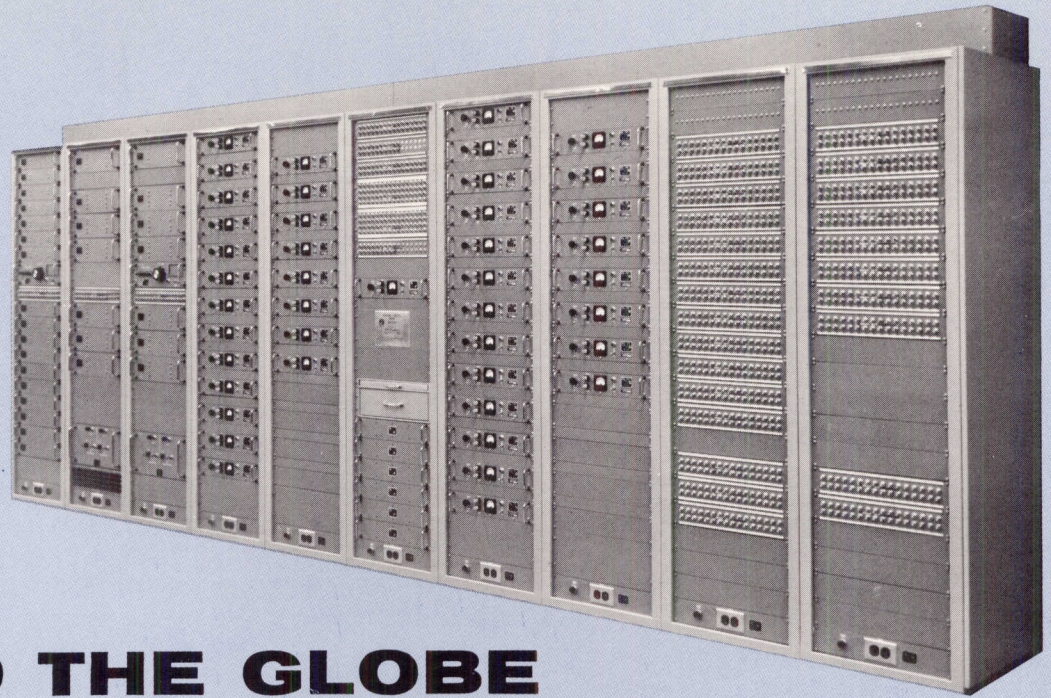

AROUND THE GLOBE

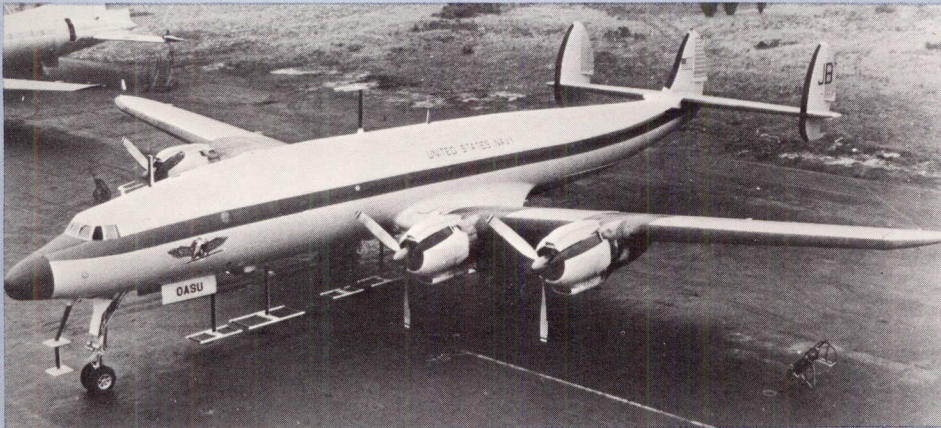

A product of our new air-borne division, a converted Lockheed Super Constellation providing wideband television transmission, FM and AM broadcasts with long range high frequency capability. This aircraft is now flying in Viet Nam.

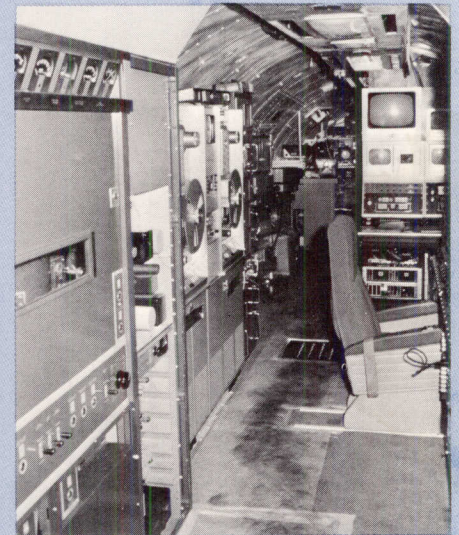

An interior view of the plane shown to the left showing some of the TV and broadcast monitoring and control equipment.



Interior view of radio station WWV showing some of the station personnel adjusting one of the transmitters.



Station WWV, The National Bureau of Standard's Frequency and Time Standards Station in Ft. Collins, Colorado was inaugurated on 1 December 1966. This worldwide service is accomplished by TMC 10 and 40 kW transmitters providing 24 hour service.

