

TECHNICAL MANUAL
for

RTTY RECEIVING SYSTEM

MODEL SYM3204A

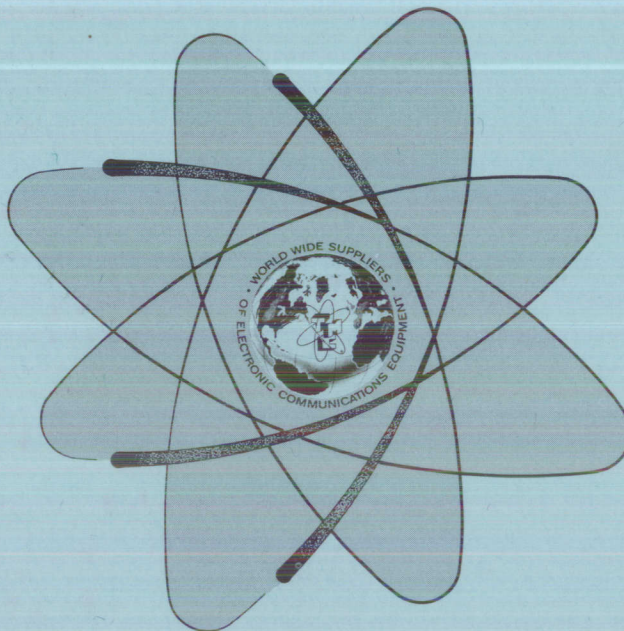

THE TECHNICAL MATERIEL CORPORATION
MAMARONECK, N.Y.

OTTAWA, ONTARIO

COPYRIGHT 1971
THE TECHNICAL MATERIEL CORPORATION

Printed in U.S.A.

TECHNICAL MANUAL
for

RTTY RECEIVING SYSTEM

MODEL SYM3204A

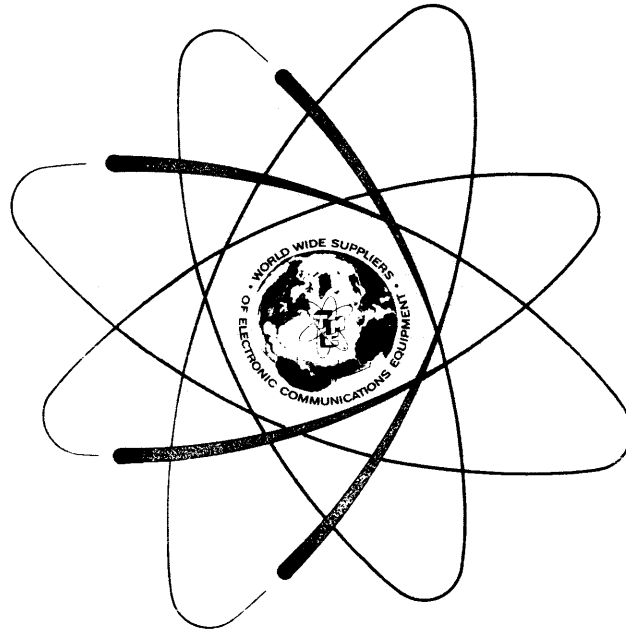

THE TECHNICAL MATERIEL CORPORATION
MAMARONECK, N.Y. OTTAWA, ONTARIO

COPYRIGHT 1971
THE TECHNICAL MATERIEL CORPORATION

Printed in U.S.A.

IN 3204A

Issue Date: APRIL 1975

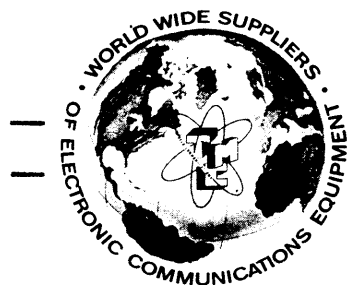

THE TECHNICAL MATERIEL CORPORATION

C O M M U N I C A T I O N S E N G I N E E R S

700 FENIMORE ROAD

MAMARONECK, N. Y.

W a r r a n t y

The Technical Materiel Corporation, hereinafter referred to as TMC, warrants the equipment (except electron tubes,* fuses, lamps, batteries and articles made of glass or other fragile or other expendable materials) purchased hereunder to be free from defect in materials and workmanship under normal use and service, when used for the purposes for which the same is designed, for a period of one year from the date of delivery F.O.B. factory. TMC further warrants that the equipment will perform in a manner equal to or better than published technical specifications as amended by any additions or corrections thereto accompanying the formal equipment offer.

TMC will replace or repair any such defective items, F.O.B. factory, which may fail within the stated warranty period, PROVIDED:

1. That any claim of defect under this warranty is made within sixty (60) days after discovery thereof and that inspection by TMC, if required, indicates the validity of such claim to TMC's satisfaction.
2. That the defect is not the result of damage incurred in shipment from or to the factory.
3. That the equipment has not been altered in any way either as to design or use whether by replacement parts not supplied or approved by TMC, or otherwise.
4. That any equipment or accessories furnished but not manufactured by TMC, or not of TMC design shall be subject only to such adjustments as TMC may obtain from the supplier thereof.

Electron tubes*furnished by TMC, but manufactured by others, bear only the warranty given by such other manufacturers. Electron tube warranty claims should be made directly to the manufacturer of such tubes.

TMC's obligation under this warranty is limited to the repair or replacement of defective parts with the exceptions noted above.

At TMC's option any defective part or equipment which fails within the warranty period shall be returned to TMC's factory for inspection, properly packed with shipping charges prepaid. No parts or equipment shall be returned to TMC, unless a return authorization is issued by TMC.

No warranties, express or implied, other than those specifically set forth herein shall be applicable to any equipment manufactured or furnished by TMC and the foregoing warranty shall constitute the Buyers sole right and remedy. In no event does TMC assume any liability for consequential damages, or for loss, damage or expense directly or indirectly arising from the use of TMC Products, or any inability to use them either separately or in combination with other equipment or materials or from any other cause.

*Electron tubes also include semi-conductor devices.

TABLE OF CONTENTS

<u>Paragraph</u>		<u>Page</u>
<u>SECTION 1 - GENERAL INFORMATION</u>		
1-1	Functional Description	1-1
1-2	Physical Description	1-1
	a. Power Supply, PSP-1	1-1
	b. Frequency Shift Tone Keyer Shelf, Type 325.	1-1
	c. Frequency Shift Tone Keyer, 211 Model 1	1-1
	d. Power Supply, 251 Model 3	1-1
	e. Frequency Shift Converter, 174 Model 3	1-2
	f. Handset and Cradle	1-2
	g. Speaker Panel, 699J-1	1-2
	h. HF Receiver, 651S-1	1-2
	i. Microphone Preamplicifier, MPA-1	1-2
	j. AF/DC Jackfield	1-2
	k. Power Control Panel, DCP-2	1-2
1-3	Reference Data	1-2
<u>SECTION 2 - INSTALLATION</u>		
2-1	Initial Unpacking and Inspection	2-1
2-2	Power Requirements	2-1
2-3	Installation	2-1
	a. General	2-1
	b. Mechanical Installation	2-1
	(1) Cabinet Location	2-1
	(2) Component Location	2-2
	c. Electrical Installation	2-5
	(1) Electrical Interconnection	2-5
	(2) Interface Panel Connections	2-5
	(3) Antenna Input Connection.	2-6
	(4) Primary Power Connection.	2-6
<u>SECTION 3 - OPERATOR'S SECTION</u>		
3-1	General	3-1
3-2	Controls and Indicators	3-1
	a. AF/DC Jackfield	3-1
	b. Handset and Cradle	3-3
3-3	Operating Procedures	3-3

TABLE OF CONTENTS (cont)

<u>Paragraph</u>		<u>Page</u>
<u>SECTION 4 - PRINCIPLES OF OPERATION</u>		
4-1	Introduction	4-1
4-2	Block Diagram Analysis	4-1
<u>SECTION 5 - MAINTENANCE</u>		
5-1	Preventive Maintenance	5-1
5-2	Troubleshooting	5-1
<u>SECTION 6 - PARTS LIST</u>		

LIST OF TABLES

<u>Table</u>		<u>Page</u>
2-1	SYM3204A Components Packaged Separately	2-2
2-2	SYM3204A Loose Items Supplied	2-2
2-3	Interface Panel Connections	2-6
3-1	Functions of AF/DC Jackfield	3-1
6-1	Parts List for SYM3204A Receiving System	6-2
6-2	Parts List for AF/DC Jackfield	6-3

LIST OF FIGURES

<u>Figure</u>		<u>Page</u>
1-1	RTTY Receiving System SYM3204A	1-0
2-1	SYM3204A Cabinet Dimensions	2-3
2-2	SYM3204A Component Location	2-4
2-3	SYM3204A Interconnect Wiring Diagram	2-7
3-1	AF/DC Jackfield	3-1
4-1	Block Diagram, SYM3204A Receiving System	4-2

SECTION 1

GENERAL INFORMATION

1-1. FUNCTIONAL DESCRIPTION

The RTTY Receiving System, TMC Model SYM3204A is designed for independent sideband reception in the hf range. The voice intelligence (normally USB) from the receiver portion is applied to a front panel speaker or to the receive section of a front panel handset. The tone intelligence (normally LSB) is applied to a frequency shift unit which converts the signal into dc pulses suitable for operating TTY receive equipment. The SYM3204A also accepts dc pulses from TTY send equipment for frequency shift keying of an audio tone, providing an FSK signal suitable for transmission on an associated transmitting system. The voice intelligence from the send section of the handset is applied to a mike preamplifier unit, the output of which is an audio signal suitable for transmission. The system also includes an af/dc patch panel that provides the operator with system flexibility by enabling the selection of inputs and outputs of the various system components.

1-2. PHYSICAL DESCRIPTION

The SYM3204A receiving system (shown in figure 1-1) is comprised of modular units mounted in an equipment cabinet. The modular units are described briefly in the paragraphs which follow; for more detailed information pertaining to these units, refer to the technical manuals for the individual modular units.

a. POWER SUPPLY, PSP-1. The PSP-1 provides a source of dc current, for use in communication circuits where a dc battery is used for keying relays, teleprinter equipment, or any similar terminal equipment.

b. FREQUENCY SHIFT TONE KEYS SHELF, TYPE 325. The 325 keyer shelf provides a mounting for holding the 211 frequency shift tone keyer and the 251 power supply. The keyer shelf includes a line isolation transformer and attenuator for adjusting the level of the outgoing tone signals, as well as terminal blocks for making all necessary external and dc connections to the 211 keyer.

c. FREQUENCY SHIFT TONE KEYS, 211 MODEL 1. The 211 tone keyer accepts intelligence (dc pulses) from TTY send equipment (external to the SYM3204A system) for frequency shifting an audio tone. The center frequency of the audio tone is 2550 Hz, and the frequency shift of the tone is +425 Hz. The tone output of the 211 keyer is suitably amplified and controlled for inclusion in the transmission facility (external to the SYM3204A system).

d. POWER SUPPLY, 251 MODEL 3. The 251 power supply provides a source of operating power for the 211 tone keyer. Both the 251 power supply and 211 tone keyer are mounted in the 325 keyer shelf.

e. FREQUENCY SHIFT CONVERTER, 174 MODEL 3. The 174 converter accepts the frequency shifted audio output signal from one (or two) radio receivers and converts it into dc pulses suitable for operation of TTY receive equipment (external to the SYM3204A system).

f. HANDSET AND CRADLE. The handset and cradle incorporates a microphone, a receiver, a push-to-talk switch and a cradle switch. When the handset is lifted from the cradle, the cradle switch disconnects the audio from the SYM3204A front panel speaker so that the audio is heard only on the handset receiver. The handset unit allows the operator to receive signals provided by the 651S-1 receiver unit and to voice modulate an associated transmitter (external to the SYM3204A system).

g. SPEAKER PANEL, 699J-1. The speaker panel (standard 19-inch) allows rack mounting of the 651S-1 receiver and includes an 8 ohm, 4 watt speaker.

h. HF RECEIVER, 651S-1. The 651S-1 receiver is a general purpose/general coverage receiver operating in the 250-kHz to 29.9999-MHz frequency range. In the SYM3204A system the 651S-1 receiver is primarily used in the LSB mode and provides two audio outputs (STD CKT/USB and LSB CKT/LSB). The USB signal is normally voice intelligence and applied to the speaker panel and to the handset; the LSB signal is normally tone intelligence and applied to the 174 frequency shift converter.

i. MICROPHONE PREAMPLIFIER, MPA-1. The MPA-1 provides microphone preamplification of the voice signal from the handset before application to an associated transmitter. The MPA-1 includes a front panel gain control and output level meter monitoring.

j. AF/DC JACKFIELD. The af/dc jackfield is a system patch panel which provides audio (tone and voice) and dc loop inputs and outputs of all component units within the SYM3204A system. The various patching possibilities provided by the af/dc jackfield give flexibility to SYM3204A receiving system.

k. POWER CONTROL PANEL, DCP-2. The DCP-2 receives the primary power input and provides control of the ac power to the SYM3204A system with a front panel circuit breaker. The DCP-2 control panel also includes a main power indicator lamp and fused ac utility outlets.

1-3. REFERENCE DATA

For detailed technical specifications for the SYM3204A receiving system, refer to the technical specifications in the individual technical manuals for the modular units which comprise the system.

SECTION 2
INSTALLATION

2-1. INITIAL UNPACKING AND INSPECTION

The SYM3204A receiving system was assembled, calibrated and tested at the factory before shipment. Inspect all packages for possible damage during transit. With respect to damage to the equipment for which the carrier is liable, The Technical Materiel Corporation will assist in describing methods of repair and in furnishing of replacement parts. Carefully unpack each crate as indicated by the packing list provided with the receiving system shipment. Inspect all packing materials for parts that may have been shipped as loose items (mounting hardware, connectors, etc.).

2-2. POWER REQUIREMENTS

The units of the SYM3204A receiving system leave the factory wired for 220 vac, 50 Hz operation; change may be made to 115 vac, 60 Hz operation by making minor wiring changes. Refer to the installation sections of the technical manuals for each modular unit receiving line voltage.

CAUTION

If 115 vac, 60 Hz operation is used,
all line fuses must be increased to
twice their rated current values to
provide proper circuit protection.

2-3. INSTALLATION

a. GENERAL. A minimum number of assemblies, subassemblies, components and hardware have been disassembled from the equipment and separately packaged, thus reducing the possibility of equipment damage during transit. This method of disassembly and separate packaging also permits realistic equipment handling. Cables, wires, and other miscellaneous items that were disconnected during equipment disassembly for shipment are tagged and taped to the equipment. The information on a given tag indicates the designated terminal on a component to which the tagged item will be connected during installation.

b. MECHANICAL INSTALLATION. The SYM3204A receiving system should be mechanically installed by locating the equipment cabinet in an appropriate site and by installing the components that were removed during disassembly for shipment.

(1) Cabinet Location. The equipment cabinet may be located in any enclosure (room, deck or van) with sufficient clearances and with adequate ventilation. The cabinet dimensions and mounting details are shown in figure 2-1.

A clearance of approximately two feet should be left on the sides, rear and top of the equipment cabinet for ease of access and for adequate heat dissipation. In addition to the cabinet depth dimension (shown in figure 2-1) is the extension of the console table (shown in figure 2-2); the console table extends approximately 13-1/2 inches out from the edge of the cabinet.

(2) Component Installation. The component location for the SYM3204A receiving system is shown in figure 2-2. The components that were removed from the SYM3204A during disassembly for shipment are listed in table 2-1; the loose items, supplied with the system and required for its installation and operation, are listed in table 2-2.

Table 2-1. SYM3204A Components Packaged Separately

Item Number*	Designation	Description
1	PSP-1	Power Supply
7	651S-1	HF Receiver
10		Console Table

* Note: Item numbers are referenced to figure 2-2.

Table 2-2. SYM3204A Loose Items Supplied

Quantity	Part Number	Description	Function
1	UG260/U	Connector	Antenna input connection
1	TM105-12AL	Terminal Strip	Teletype equipment connections
1	TM105-12AR	Terminal Strip	Audio line connections
1	PL190-NG	Electrical Plug	Primary power input connection
5	CA566-2	Patch Cable	AF/DC jackfield connections
4	_____	Wood Screw	Console table mounting
4	SCBP1032BN10	Screw	Console table mounting
4	FW10HBN	Flat Washer	Console table mounting
4	WA101-5	Fiber Washer	Console table mounting
2	_____	Brackets	Console table mounting

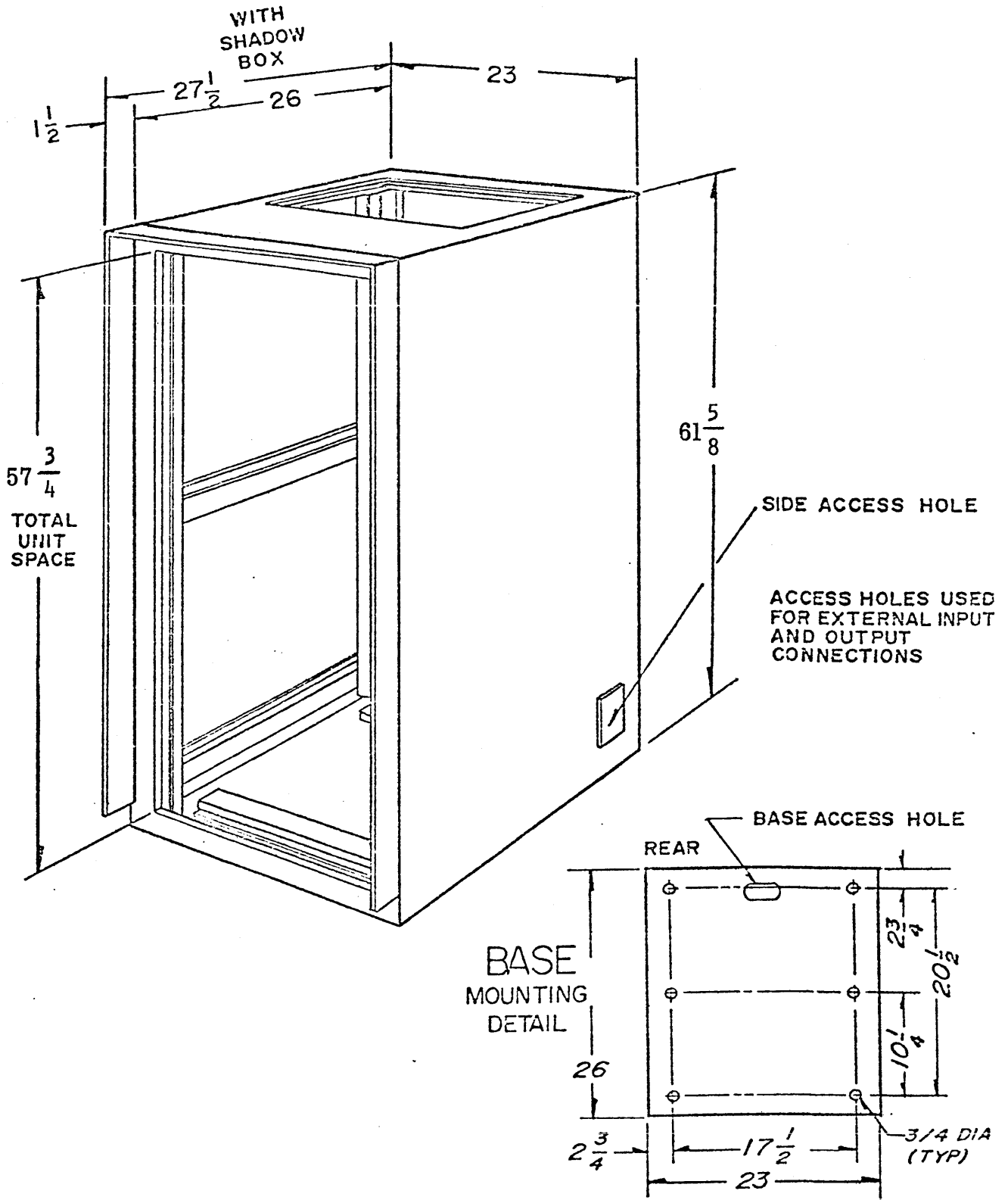
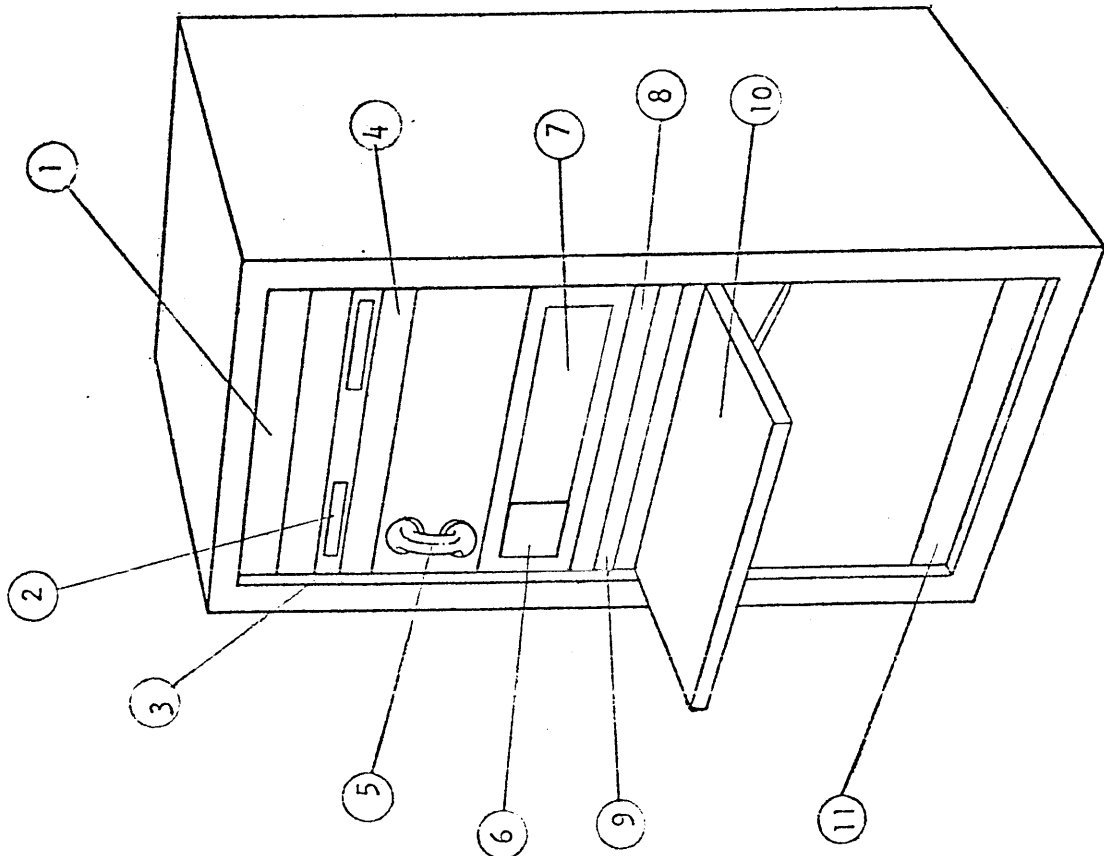

Figure 2-1. SYM3204A Cabinet Dimensions



Key to Figure 2-2

1. Power Supply, Model PSP-1
2. Frequency Shift Tone Keyer Type 211 Model 1
3. Dual Frequency Shift Tone Keyer Shelf Type 325 Model 1A
4. Frequency Shift Diversity Converter Type 174 Model 3
5. Handset
6. Speaker Panel
7. High Frequency Receiver, Model 651S-1
8. Microphone Preamplifier, Model MPA-1
9. AF/DC Jackfield
10. Console Table
11. Power Control Panel, Model DCP-2

Figure 2-2. SYM3204A Component Location

The PSP-1 power supply and 651S-1 receiver units should be installed in their proper positions within the equipment cabinet (reference figure 2-2) and secured in place, using the appropriate mounting hardware. The internal cabinet wiring connections should then be made to these units (reference figure 2-3 and wire designation tags).

The console table should be installed in its proper position (reference figure 2-2) in accordance with the following procedure:

(a) Using the appropriate hardware, mount the brackets so that the top edge of the brackets is flush with the top edge of the blank panel (located just below the console table position).

(b) Lift the console table (formica side up), and slide it into the open position between the two blank panels.

(c) Force the table back against the frame of the cabinet, and allow it to rest on the top of the brackets.

(d) Using the four wood screws supplied, secure the brackets to the underside of the console table.

c. ELECTRICAL INSTALLATION.

WARNING

BEFORE MAKING EXTERNAL CONNECTIONS TO THE SYM3204A RECEIVING SYSTEM, INSURE THAT THE EXTERNAL PRIMARY POWER SOURCE IS OFF AND TAGGED.

(1) Electrical Interconnection. Refer to the interconnect wiring diagram (figure 2-3), and connect all plugs and wires, that are not already connected, to their respective jacks and terminals. All interconnecting cables and wires are tagged, indicating their designated terminals.

(2) Interface Panel Connections. External intelligence connections are made at the interface panel, located in the lower-rear portion of the equipment cabinet. There are two terminal jacks on the interface panel; TB1 (located on right side, when viewed from rear) is used for audio line output connections, TB2 (located on left side) is used for connection of both send and receive TTY equipments. The TM105-12AL and TM105-12AR terminal strips (supplied as loose items) should be utilized when making these connections. Table 2-3 lists the interface panel connection.

TABLE 2-3. Interface Panel Connections

Terminals	Function	Connection
TB1-1,2,3	USB line audio output to associated transmitter.	Connect audio lines to pins 1,2 and 3 on TB1. Use shielded pair; pin 3 is the shield connection.
TB1-5,6,7	LSB line audio output to associated transmitter.	Connect audio lines to pins 5, 6 and 7 on TB1. Use shielded pair; pin 7 is the shield connection.
TB2-1,2,3	Set 2 converter output to TTY receive equipment.	Connect TTY lines to pins 1, 2, and 3 on TB2. Use shielded pair; pin 3 is the shield connection.
TB2-4,5,6	Set 1 converter output to TTY receive equipment.	Connect TTY lines to pins 4,5 and 6 on TB2. Use shielded pair; pin 6 is the shield connection.
TB2-7,8,9	Set 2 keyer input from TTY send equipment.	Connect TTY lines to pins 7,8 and 9 on TB2. Use shielded pair; pin 9 is the shield connection.
TB2-10,11,12	Set 1 keyer input from TTY send equipment.	Connect TTY lines to pins 10, 11 and 12 on TB2. Use shielded pair; pin 12 is the shield connection.

NOTE

If TTY send/receive equipments are not connected to TB2 terminals, jumpers must be connected to complete loops (pins 1 and 2, 4 and 5, 7 and 8, and 10 and 11).

(3) Antenna Input Connection. The antenna input connection to the SYM3204A receiving system is made directly to the 651S-1 receiver. Using the UG260/U connector (supplied as a loose item), connect the antenna cable (50-ohm transmission line) to J61 on the rear of the 651S-1 receiver.

(4) Primary Power Connection. The SYM3204A receiving system leaves the factory wired for 220 vac, 50 Hz operation, unless otherwise specified by the customer. Primary power connection is made to the power jack located in the bottom-rear of the equipment cabinet. Using the PL190-NG electrical plug (supplied as a loose item), connect the primary power input lines to the power jack.

D

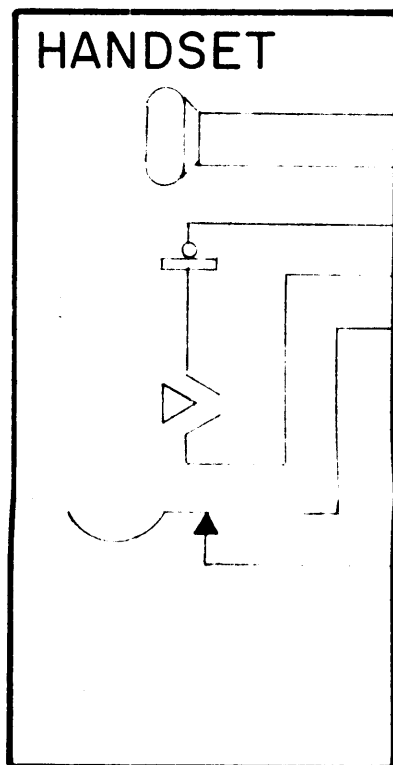
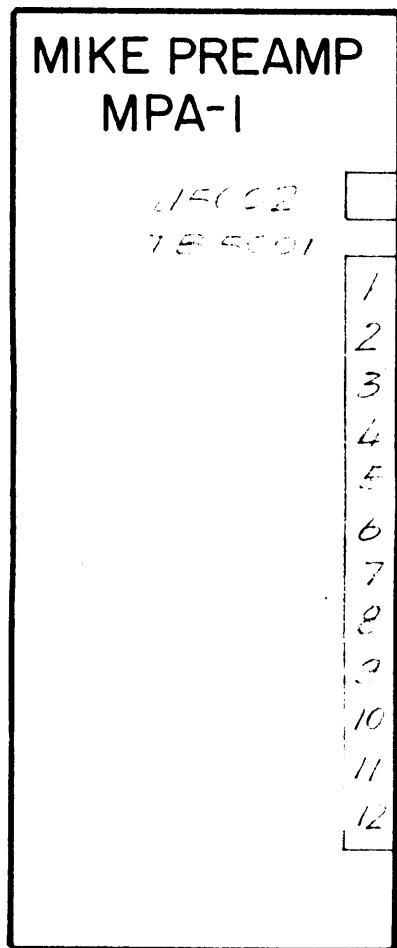
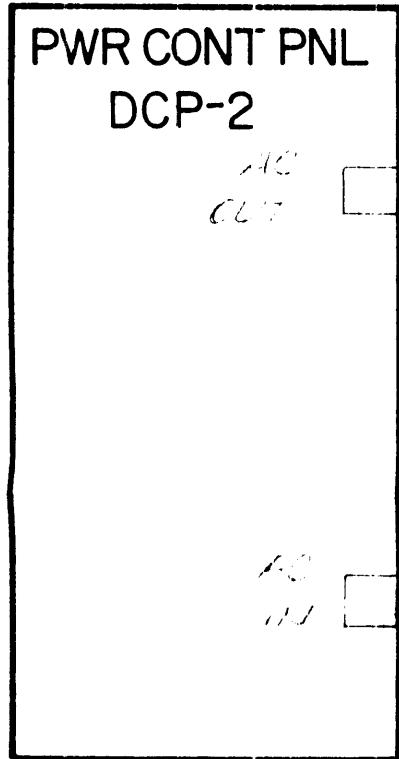

1.44 110V 1WR
1111-11
2.40 110V
FC 110V

C



B

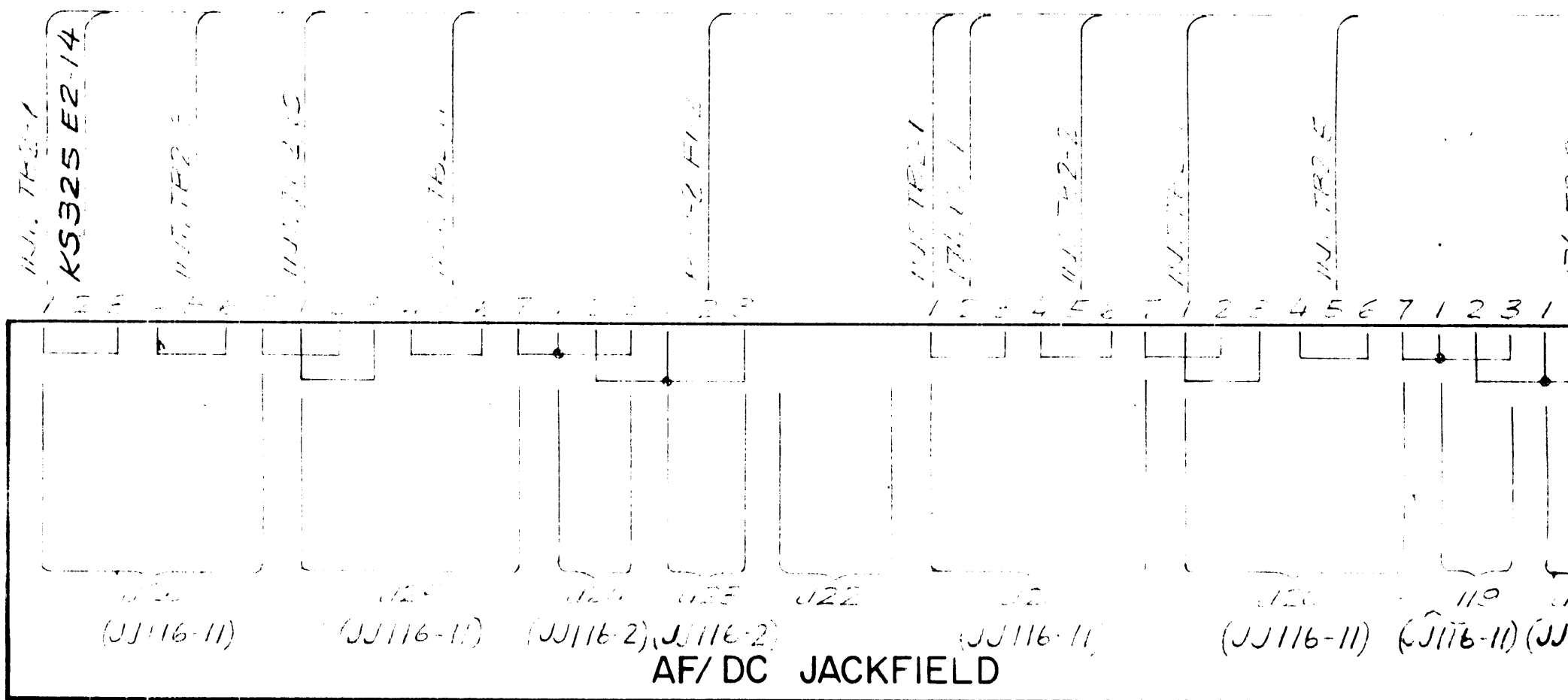

3

2

1

REVISIONS					DATE	APPROVED
E.M.N.NO	DRAFT	CHKD	ZONE	LTR	DESCRIPTION	
	D.L.			0		5-1-75

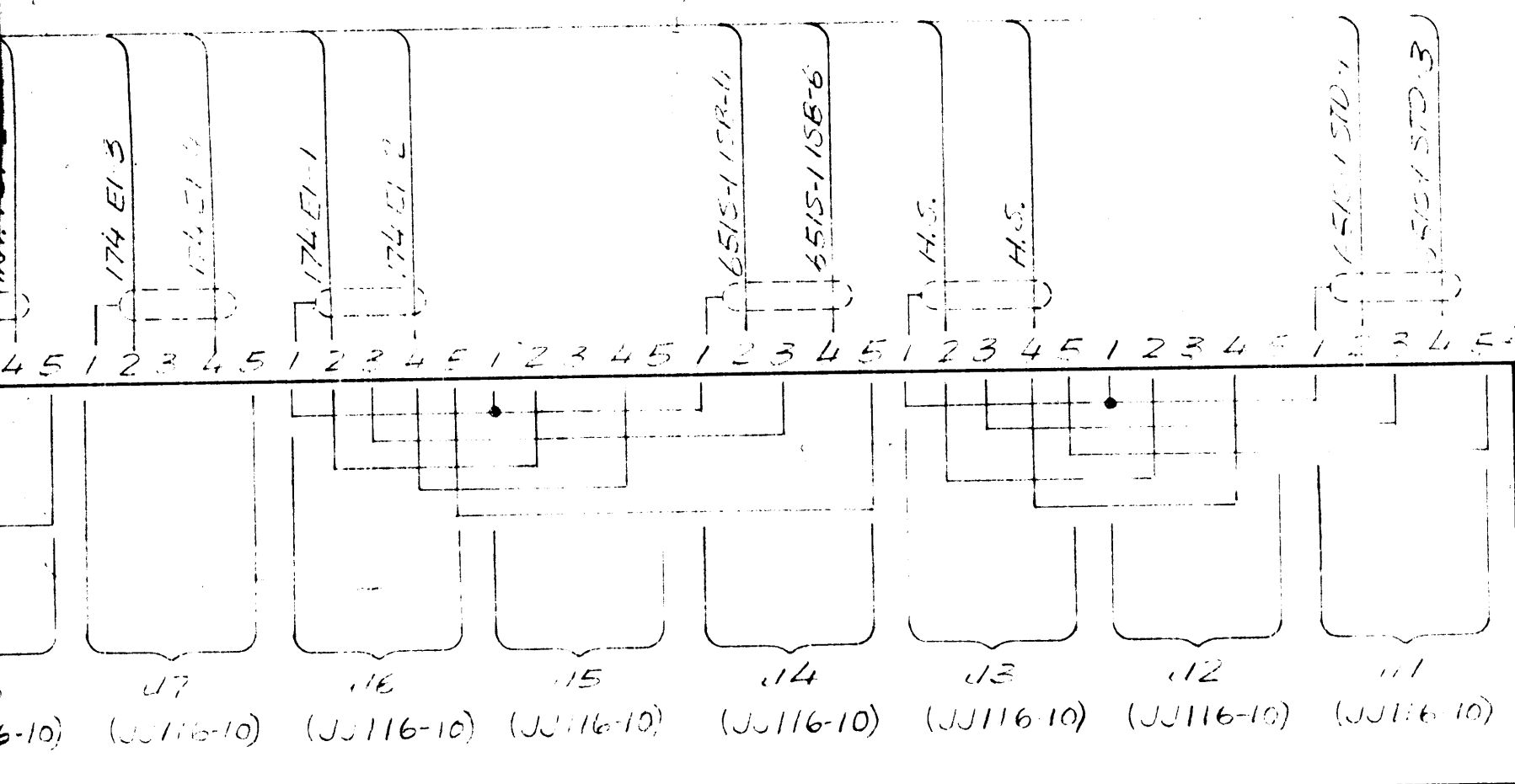
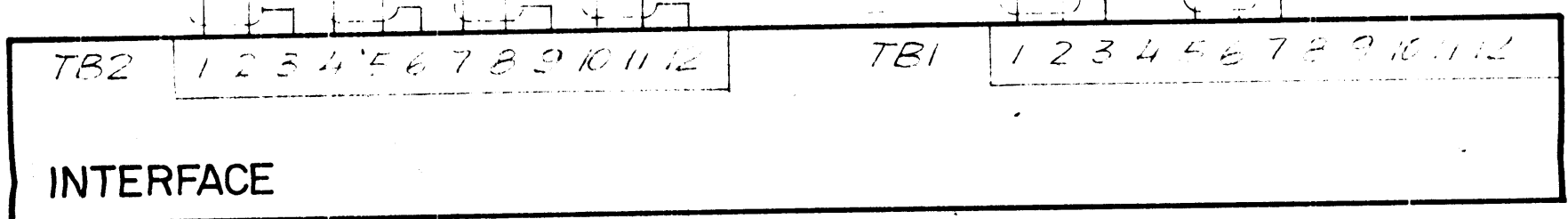
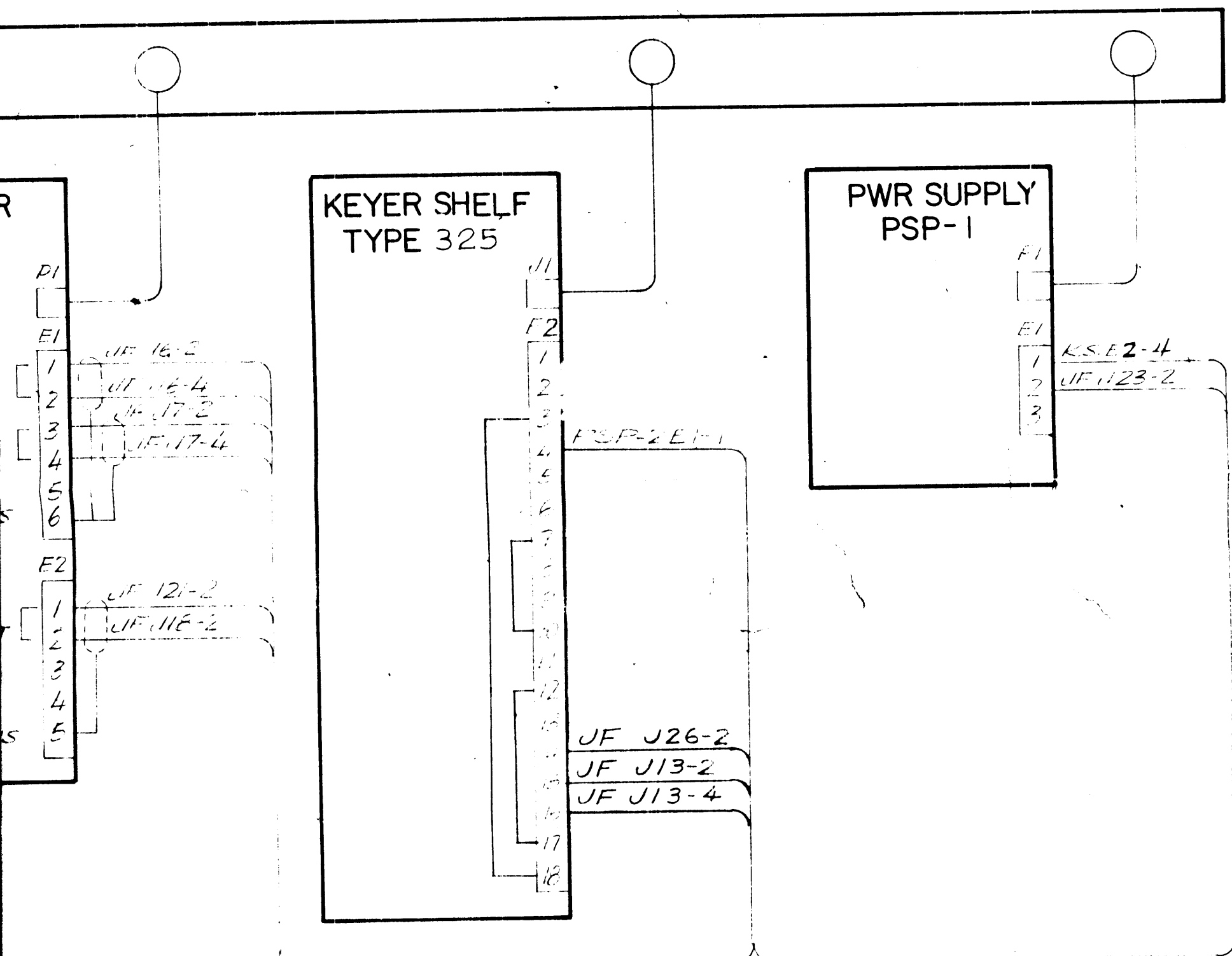

D

C

B

U 2086

C

B

A

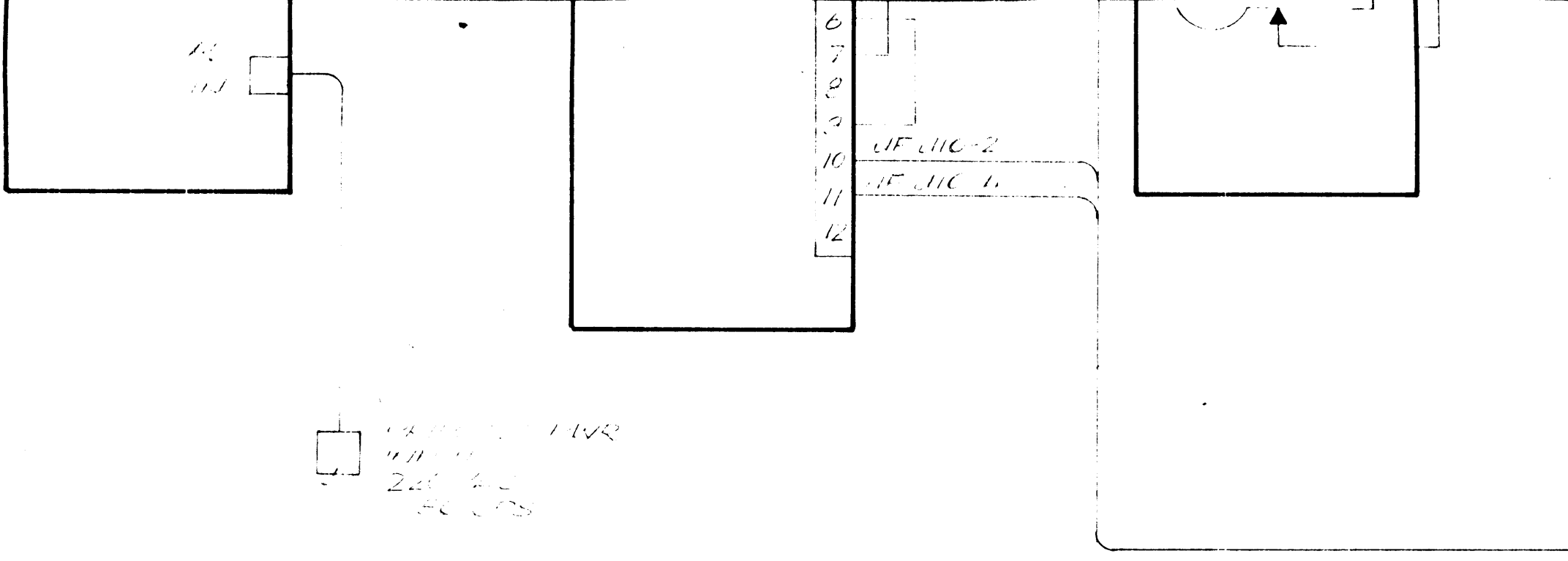

14 11 12 13 14 15 16 17 18 19 20 21 22 23 24 25 26 27 28 29 30 31 32 33 34 35 36 37 38 39 40 41 42 43 44 45 46 47 48 49 50 51 52 53 54 55 56 57 58 59 60 61 62 63 64 65 66 67 68 69 70 71 72 73 74 75 76 77 78 79 80 81 82 83 84 85 86 87 88 89 90 91 92 93 94 95 96 97 98 99 100
 24 25 26 27 28 29 30 31 32 33 34 35 36 37 38 39 40 41 42 43 44 45 46 47 48 49 50 51 52 53 54 55 56 57 58 59 60 61 62 63 64 65 66 67 68 69 70 71 72 73 74 75 76 77 78 79 80 81 82 83 84 85 86 87 88 89 90 91 92 93 94 95 96 97 98 99 100

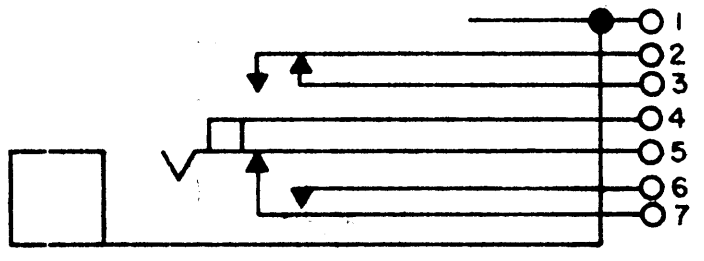
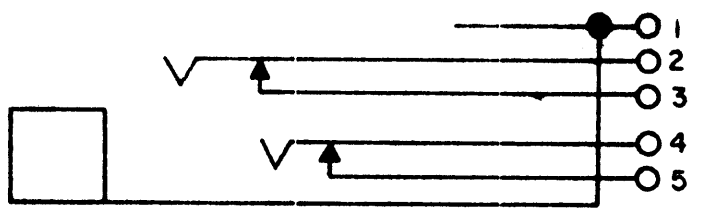
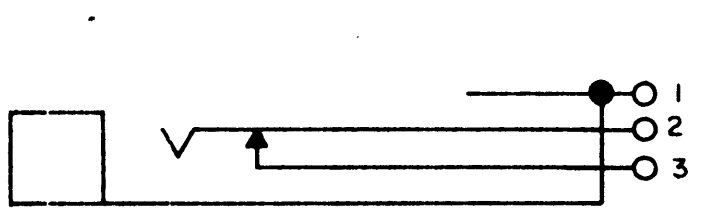
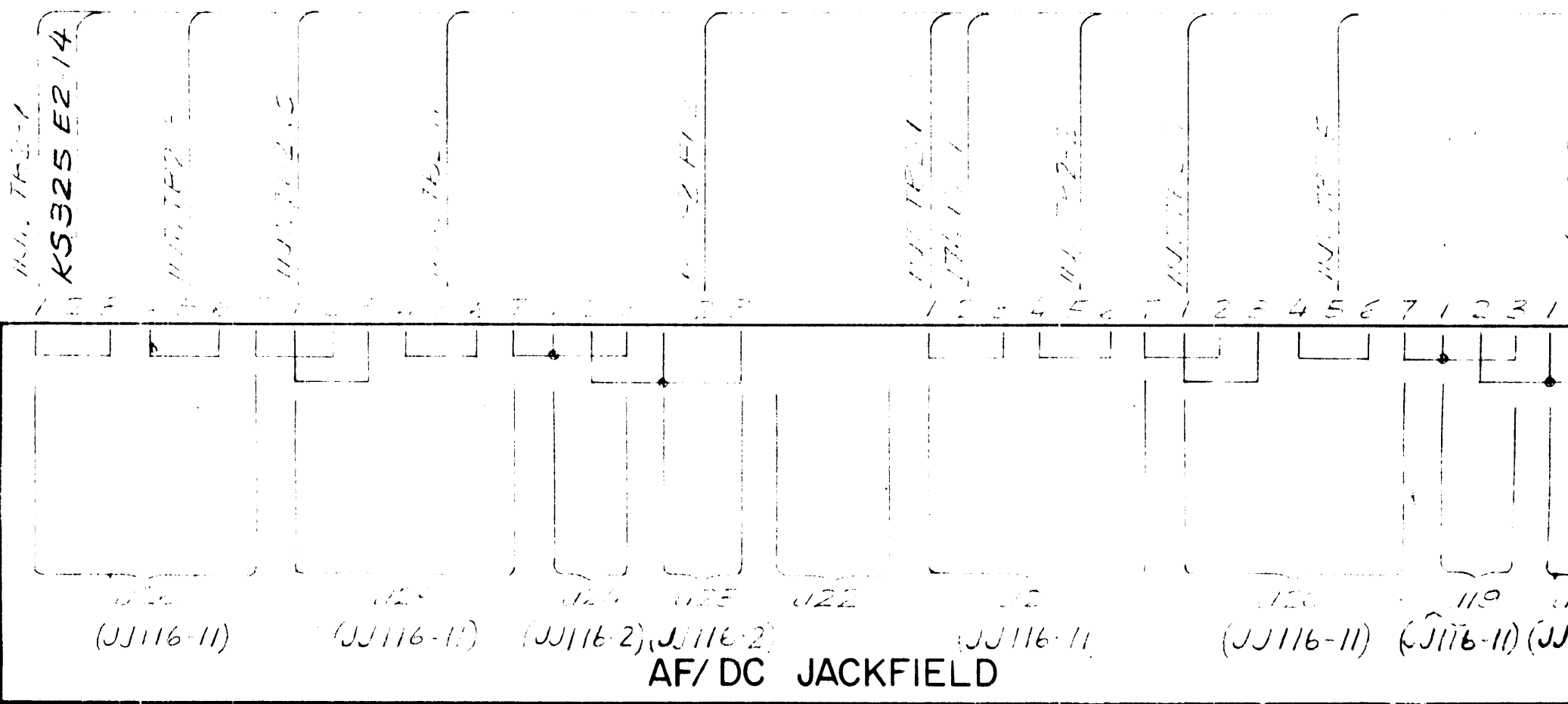

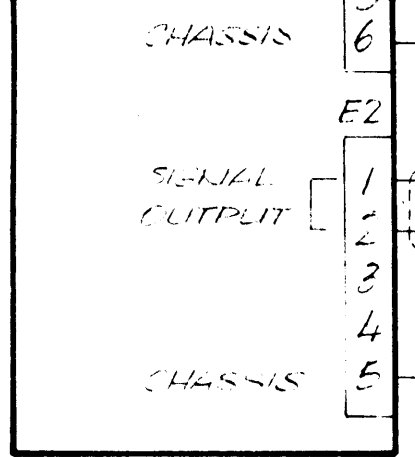
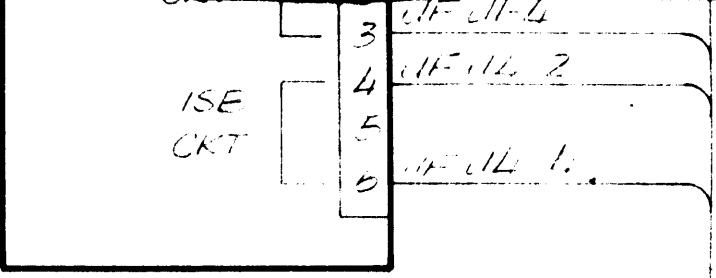

TB2
INTE

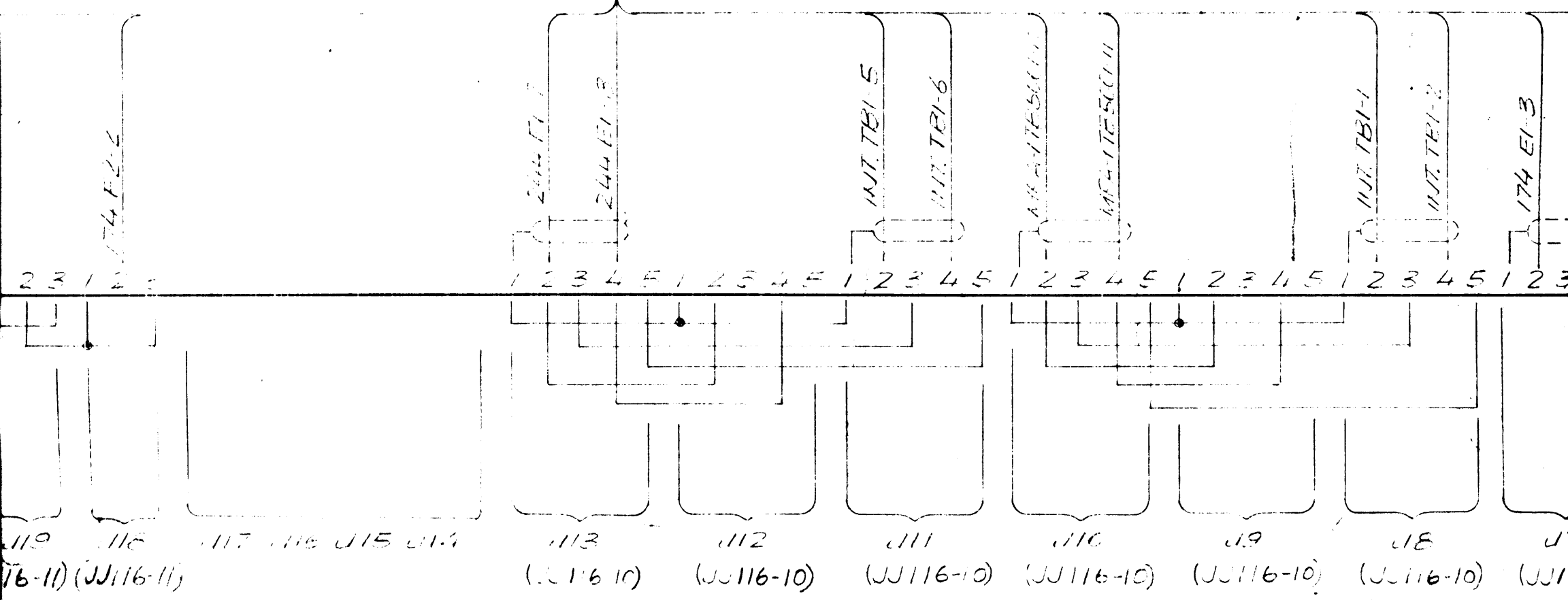

WIRE IDENTIFICATION

- INT. INTERFACE
- H.S. -- HAND SET
- K.S. -- KEYS - HALF
- JF -- JACK FIELD

J116-10

SYM 3204A		
QTY / UNIT	MODEL USED ON	ASS'Y NO.
APPLICATION		
	CODE	
<p>NOTICE TO PERSONS RECEIVING THIS DRAWING THE TECHNICAL MATERIEL CORPORATION claims proprietary right in the material disclosed hereon. This drawing is issued in confidence for engineering information only and may not be reproduced or used to manufacture anything shown hereon without permission from THE TECHNICAL MATERIEL CORPORATION to the user. This drawing is loaned for mutual assistance and is subject to recall at any time.</p>		

5

4

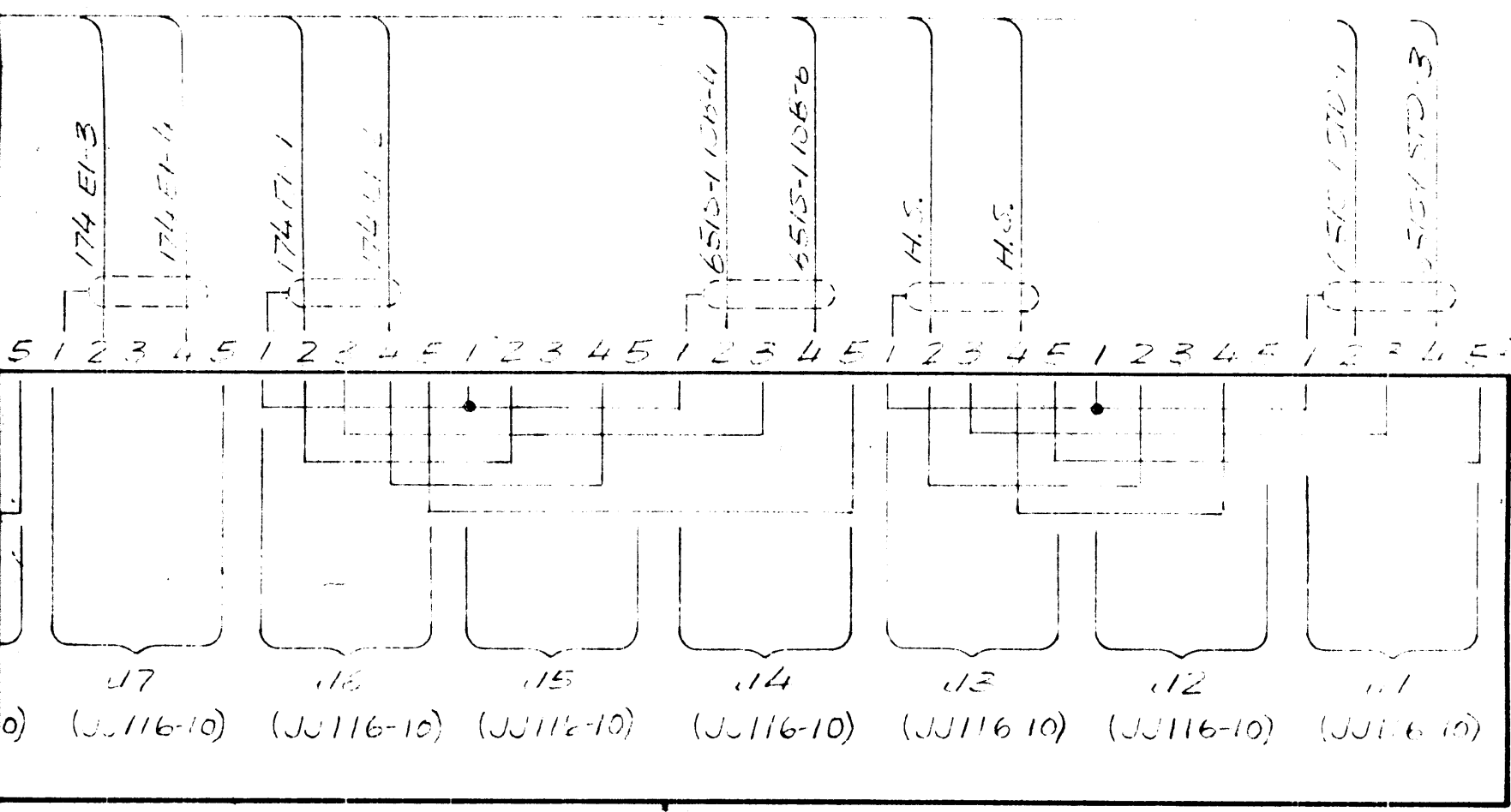
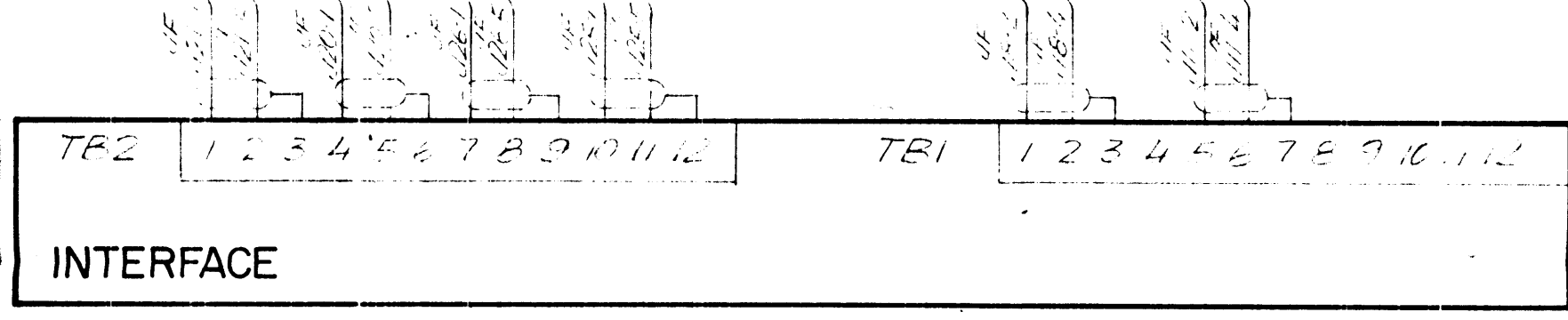
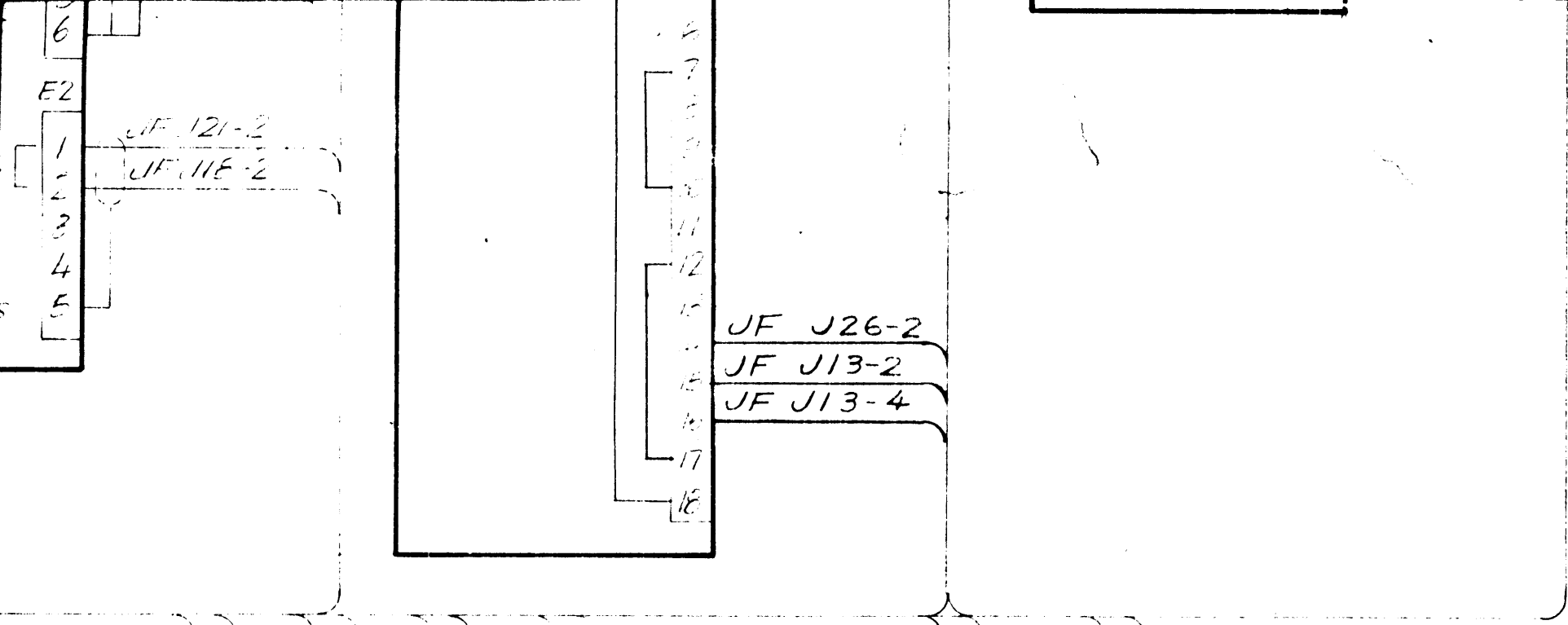

QTY. REQ.	ITEM	PART NO.	DESCRIPTION	SYMBOL
LIST OF MATERIAL				
UNLESS OTHERWISE SPECIFIED DIMENSIONS ARE IN INCHES AND INCLUDE CHEMICALLY APPLIED OR PLATED FINISHES		FINAL APPROVAL	DATE	THE TECHNICAL MATERIEL CORP. MAMARONECK, NEW YORK Figure 2-3. Interconnect Wiring Diagram, RTTY Receiving System SYM3204A
TOLERANCES ON		MECH. DES.	DATE	
		ELECT. DES.	DATE	
DECIMALS	FRACTIONS	CHECKED	DATE	
.X ± .05	± 1/64	DRAWN	DATE	
.XX ± .01	ANGLES	<i>W. J. BURNS</i> <i>5/11/75</i>		
.XXX ± .005	± 0° -30'			
MATERIAL				
FINISH				

2-7/2-8

C

B

47808

A

3

2

1

SECTION 3

OPERATOR'S SECTION

3-1. GENERAL

This section contains general operating instructions for the SYM3204A receiving system. Detailed operating instructions for the units that comprise the system are contained in the individual technical manuals for the modular units.

3-2. CONTROLS AND INDICATORS

With the exception of the af/dc jackfield and handset and cradle, the location and function of all controls and indicators of the SYM3204A are contained in the operator's sections of the individual technical manuals for the modular units comprising the system. The operator should familiarize himself with all operating controls and indicators on the SYM3204A receiving system by referring to the individual manuals and to the paragraphs which follow.

a. AF/DC JACKFIELD. A front panel view of the af/dc jackfield is shown in figure 3-1; the jack numbers correspond to the reference designations for af/dc jacks shown on the interconnect wiring diagram, figure 2-3. Table 3-1 lists the system inputs and outputs which are available at each jack and describes the normal-thru circuits of the patch panel. The normal-thru circuits are broken by insertion of the patch cord plugs; the input/output appearing at a particular jack may thus be directed elsewhere in the system.

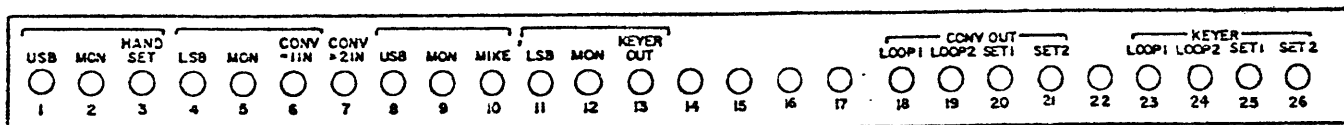

Figure 3-1. AF/DC Jackfield

Table 3-1. Functions of AF/DC Jackfield

Jack Designation	Input/Output	Normal-thru
1	USB audio output line from 651S-1 receiver (STD/CKT).	To receive section of handset.
2	Audio input line to handset for monitoring.	_____
3	Audio input line to handset.	From USB audio output.

Table 3-1. Functions of AF/DC Jackfield (cont)

Jack Designation	Input/Output	Normal-thru
4	LSB audio output line from 651S-1 receiver (ISB/CKT).	To channel 1 input on 174 converter.
5	Tone input line to 174 converter, channel 1, for monitoring.	_____
6	Tone input line to channel 1 input on 174 converter.	From LSB audio input.
7	Tone input line to 174 converter, channel 2.	_____
8	USB output line to interface panel.	From MPA-1 600-ohm output.
9	600-ohm output line from MPA-1 for monitoring.	_____
10	MPA-1 600-ohm audio output.	To USB output line on interface panel.
11	LSB output line to interface panel.	From 211 keyer output.
12	Output line from 211 keyer for monitoring.	_____
13	Output line from 211 keyer.	To LSB output line on interface panel.
14	_____	_____
15	_____	_____
16	_____	_____
17	_____	_____
18	DC loop output line from converter.	To loop 2 converter output jack.
19	DC loop line from loop 1 converter output jack.	To set 1 converter output jack.

Table 3-1. Functions of AF/DC Jackfield (cont)

Jack Designation	Input/Output	Normal-thru
20	DC loop line from loop 2 converter input jack and dc loop common input from interface panel, TB2-4.	To interface panel TB2-5 and to set 2 converter output jack.
21	DC loop line from set 1 converter output jack and dc loop common input from interface panel, TB2-1.	To interface panel TB2-2 and to dc loop common on converter.
22	_____	_____
23	DC loop output line from PSP-1 power supply.	To loop 2 keyer jack.
24	DC loop line from loop 1 keyer jack.	To set 1 keyer jack.
25	DC loop line from loop 2 keyer jack and dc loop common input from interface panel, TB2-10.	To interface panel TB2-11 and to set 2 keyer jack.
26	DC loop line from set 1 keyer jack and dc loop common input from interface panel, TB2-7.	To interface panel TB2-8 and to 325 keyer shelf E2-4.

b. HANDSET AND CRADLE. The SYM3204A USB audio signal is normalled-thru the af/dc jackfield to the receive section of the handset. Audio is also applied to the front panel speaker of the SYM3204A. Lifting the handset from the cradle disconnects the audio from the front panel speaker so that it is heard only in the receive section of the handset. Depressing the PTT button on the handset completes an audio path from the handset microphone to the MPA-1 microphone preamplifier, for application to an associated transmitting system.

3-3. OPERATING PROCEDURES

Detailed operating procedures for the individual units comprising the SYM3204A receiving system are contained in the modular technical manuals. In normal operation of the system, primary power should be applied to the SYM3204A by operation of the DCP-2 power control panel. The 651S-1 receiver should be tuned to the desired frequency and operated in the LSB mode. USB audio will be applied to the front panel speaker and to the handset; LSB tone intelligence will be applied to the 174 frequency shift converter which, when operated properly, will provide dc pulse output for operation of the associated TTY receive equipment. Operation of the transmit section of the handset and the MPA-1

microphone preamplifier will provide an audio output from the SYM3204A, suitable for transmission on an associated system. Receipt of dc pulses from TTY send equipment and proper operation of the 325 tone keyer shelf and 211 frequency shift tone keyer will provide an audio tone output from the SYM3204A, also suitable for transmission on an associated system.

The af/dc jackfield provides the SYM3204A with system flexibility. A few examples are listed below.

- a. Receipt of tone intelligence on the USB by patching the USB output to the converter #1 input.
- b. Receipt of tone intelligence on both LSB and USB by patching the USB to the converter #2 input.
- c. Retransmission of received audio by patching the USB input from the receiver, directly to the mike input.

SECTION 4

PRINCIPLES OF OPERATION

4-1. INTRODUCTION

The SYM3204A receiving system consists of an independent sideband receiver, providing USB and LSB audio outputs of voice and/or tone intelligence. The system converts tone intelligence to dc pulses for operation of associated TTY receive equipments and accepts dc pulse inputs from TTY send equipment for control of an FSK tone signal output from the system. The SYM3204A also provides a voice intelligence output from a microphone.

4-2. BLOCK DIAGRAM ANALYSIS (Refer to figure 4-1).

A 50-ohm impedance antenna input is applied to the 651S-1 receiver, normally operating in the LSB mode for this system. The USB (normally voice intelligence) and the LSB (normally tone intelligence) outputs of the receiver are routed to the system's af/dc jackfield. The jackfield provides monitoring jacks for both USB and LSB audio lines. The USB output is normalled-thru the jackfield to the receive section of a handset; the LSB output is normalled-thru the jackfield to the 174 frequency shift converter. The converter output, dc pulses, is routed to the converter output section of the jackfield. The normal-thru connections of this section of the jackfield, along with the connection of external TTY receive equipments, provide a continuous dc loop with a return line to the converter.

In addition to the receiving capabilities of the SYM3204A, the system also provides processing of voice and of dc pulses from external TTY send equipment. There are two separate line audio outputs from the SYM3204A, suitable for LSB transmission on an associated transmitter. The TTY send equipments, the normal-thru connections of the keyer section of the jackfield, the PSP-1 loop supply and the 211 frequency shift tone keyer provide the continuous dc loop for frequency shift keying of the audio tone. The audio tone output is routed from the 211 tone keyer to the af/dc jackfield, and normalled-thru to the LSB audio output. Monitoring for the LSB audio output is available on the jackfield. The handset on the SYM3204A has a microphone, the voice output of which is applied via the MPA-1 preamplifier to the af/dc jackfield and normalled-thru to the USB audio output. Monitoring for the USB audio output is also available on the jackfield.

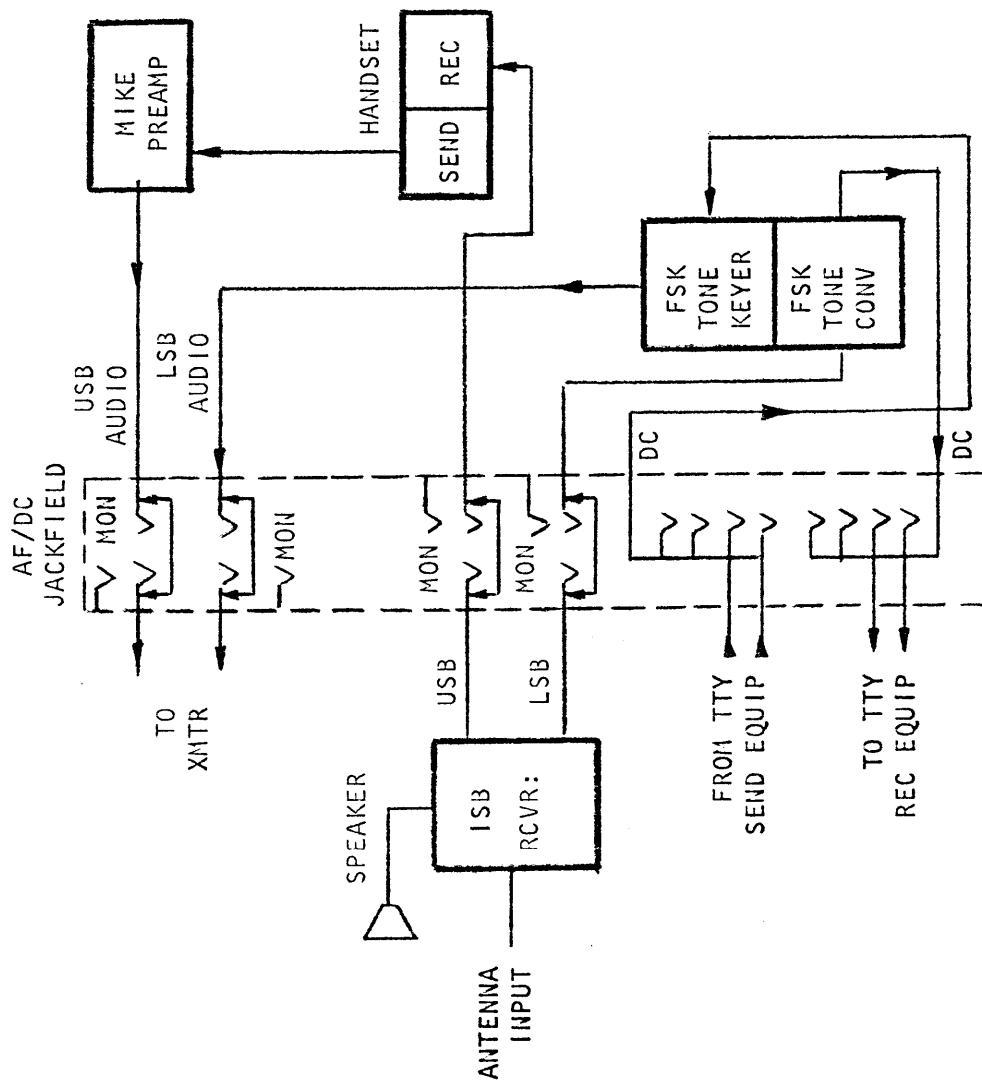

Figure 4-1. Block Diagram, SYM3204A Receiving System

SECTION 5
MAINTENANCE

5-1. PREVENTIVE MAINTENANCE

In order to prevent equipment failure due to dust, dirt or other destructive elements, it is suggested that a schedule of preventive maintenance be set up and adhered to.

At periodic intervals, the equipment should be removed from its mounting for cleaning and inspection. The wiring and all components should be inspected for dirt, dust, corrosion, grease or other harmful conditions. Remove dust with a soft brush or vacuum cleaner. Remove dirt or grease with any suitable cleaning solvent. Use of carbon tetrachloride should be avoided due to its highly toxic effects. Trichlorethylene or methyl chloroform may be used, providing the necessary precautions are observed.

WARNING

When using toxic solvents, make certain that adequate ventilation exists. Avoid prolonged or repeated breathing of the vapor. Avoid prolonged or repeated contact with skin. Flammable solvents shall not be used on energized equipment or near any equipment from which a spark may be received. Smoking, "hot work", etc. is prohibited in the immediate area.

CAUTION

When using trichlorethylene, avoid contact with painted surfaces, due to its paint removing effects.

5-2. TROUBLESHOOTING

When a piece of equipment has been operating satisfactorily and suddenly fails, the cause of failure may be due to symptoms of past failures or due to component aging.

The first step in troubleshooting is to ascertain that proper equipment voltages are present, interconnecting cables are secure, and that all fuses are in functional condition.

NOTE

Never replace a fuse with one of a high rating unless brief continued operation is more important than probable equipment damage. If a fuse burns out immediately after replacement, do not replace it a second time until the cause has been located and corrected.

Visual troubleshooting of the modular unit chassis components and tube conditions may also help localize the fault. Refer to the individual modular unit technical manuals for associated unit troubleshooting procedures.

The following troubleshooting aids are provided in this system technical manual:

- a. Interconnect Wiring Diagram for SYM3204A (figure 2-3).
- b. Block Diagram for SYM3204A (figure 4-1).

SECTION 6

PARTS LIST

The modular units which comprise the SYM3204A receiving system are listed on table 6-1. The parts list breakdowns for these units, with the exception of the af/dc jackfield, are contained in the individual technical manuals. The parts breakdown for the af/dc jackfield is listed in table 6-2.

Table 6-1. Parts List for SYM3204A Receiving System

REF SYMBOL	DESCRIPTION	TMC PART NUMBER
	Power Control Panel	DCP-2
	Microphone Preamplifier	MPA-1
	HF Receiver	651S-1
	Speaker Panel	699J-1
	Frequency Shift Converter	174 Mod. 3
	Frequency Shift Tone Keyer Shelf	325 Mod. 1A
	Frequency Shift Tone Keyer	211 Mod. 1
	Power Supply	251 Mod. 3
	Power Supply	PSP-1

Table 6-2. Parts List for AF/DC Jackfield

REF SYMBOL	DESCRIPTION	TMC PART NUMBER
J1 thru J13	Jack, Panel	JJ116-10
J14 thru J17	Not Used	
J18 thru J21	Jack, Panel	JJ116-11
J22	Not Used	
J23	Jack, Panel	JJ116-2
J24	Same as J23	
J25	Same as J18	
J26	Same as J18	