

★

**MASTER COPY**  
**DO NOT DESTROY**  
TECHNICAL MANUAL

for

**STRIP RECEIVER**

Model STR-2Y



**THE TECHNICAL MATERIEL CORPORATION**  
**MAMARONECK, N. Y.**

**OTTAWA, CANADA**

★

**MASTER COPY**  
**DO NOT DESTROY**

★

TECHNICAL MANUAL

for

STRIP RECEIVER

Model STR-2Y



THE TECHNICAL MATERIEL CORPORATION  
MAMARONECK, N. Y.

OTTAWA, CANADA

COPYRIGHT 1969  
THE TECHNICAL MATERIEL CORPORATION

#### NOTICE

THE CONTENTS AND INFORMATION CONTAINED IN THIS INSTRUCTION MANUAL IS PROPRIETARY TO THE TECHNICAL MATERIEL CORPORATION TO BE USED AS A GUIDE TO THE OPERATION AND MAINTENANCE OF THE EQUIPMENT FOR WHICH THE MANUAL IS ISSUED AND MAY NOT BE DUPLICATED EITHER IN WHOLE OR IN PART BY ANY MEANS WHATSOEVER WITHOUT THE WRITTEN CONSENT OF THE TECHNICAL MATERIEL CORPORATION.

STRIP RECEIVER  
Model STR-2Y

TMC Model STR-2B is modified to improve consistency of squelch circuit operation, and to lessen the need for critical AGC and squelch threshold adjustments. The receiver as modified is nomenclatured Model STR-2Y.

To incorporate this modification, a new printed-circuit board assembly has been added to the IF circuitry; the existing IF board has been modified to accept the additional circuitry, which mounts "piggy-back" on the original board.

The technical manual for the STR-2B applies as written to the STR-2Y, when the following exceptions are noted:

1. The schematic diagrams for the STR-2B no longer apply; the correct schematic is included with this addendum.
2. The receiver modifications provide squelch operation characteristics as stated in Clause I of the schedule for contract number FA67WA-1831, also provided with this addendum.

SCHEDULE

CLAUSE I. SUPPLIES OR SERVICES: (Continued)

Model STR-1 Receivers shall provide squelch operating characteristics as follows:

Squelch Threshold: The squelch shall enable the receiver to produce audio output at any antenna input level from one microvolt to 100,000 microvolts. The threshold adjustment will operate in conjunction with a squelch sensitivity adjustment so that threshold settings will not be unduly critical or difficult to establish after proper AGC settings have been accomplished.

Squelch Dropout : The receiver will be automatically muted within a maximum of one-half second after the input voltage at the antenna input has dropped 6 db below the squelch threshold setting between one and ten microvolts. This relationship will hold over the entire squelch adjustment range.

Model STR-2 Receivers shall provide squelch operating characteristics as follows:

Squelch Threshold: The squelch shall enable the receiver to produce audio output at any antenna input level from three microvolts to 100,000 microvolts of a 30% modulated or equivalent input. The threshold adjustment will operate in conjunction with a squelch sensitivity adjustment so that threshold settings will not be unduly critical or difficult to establish after proper AGC settings have been accomplished.

Squelch Dropout : The receiver will be automatically muted within a maximum of one-half second after the voltage at the antenna input has dropped 6 db below the squelch threshold between three and ten microvolts. This relationship will hold over the entire squelch adjustment range.

CLAUSE II. DELIVERY SCHEDULE AND POINT OF DELIVERY:

Delivery of Items 1 through 6, F.O.B. Origin, Mamaroneck, New York, shall commence within thirty (30) days and be completed within sixty (60) calendar days after date of contract. Shipping containers shall be addressed and marked as indicated below:

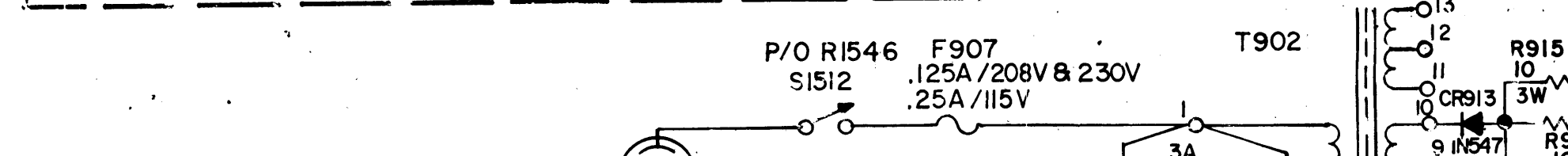
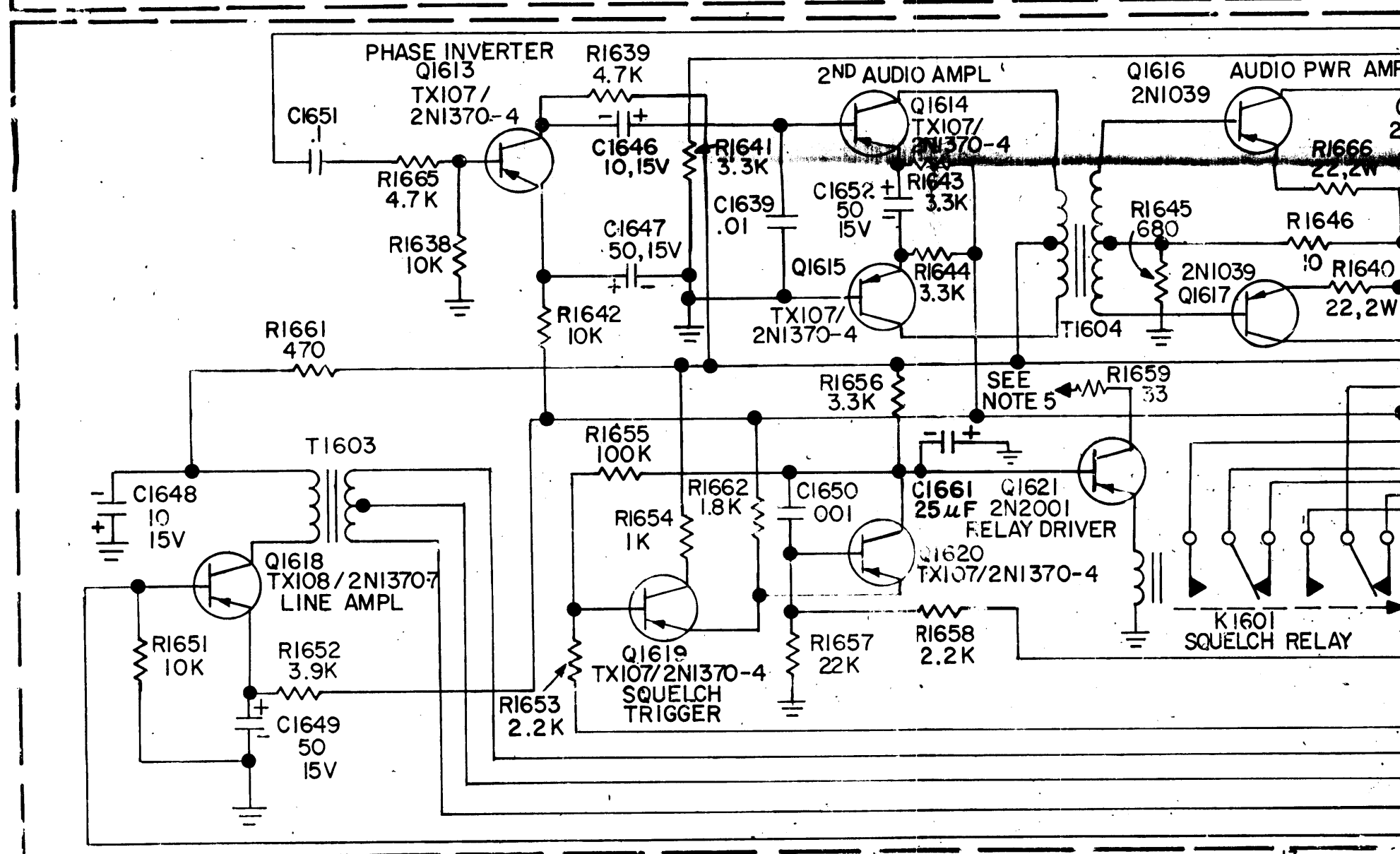
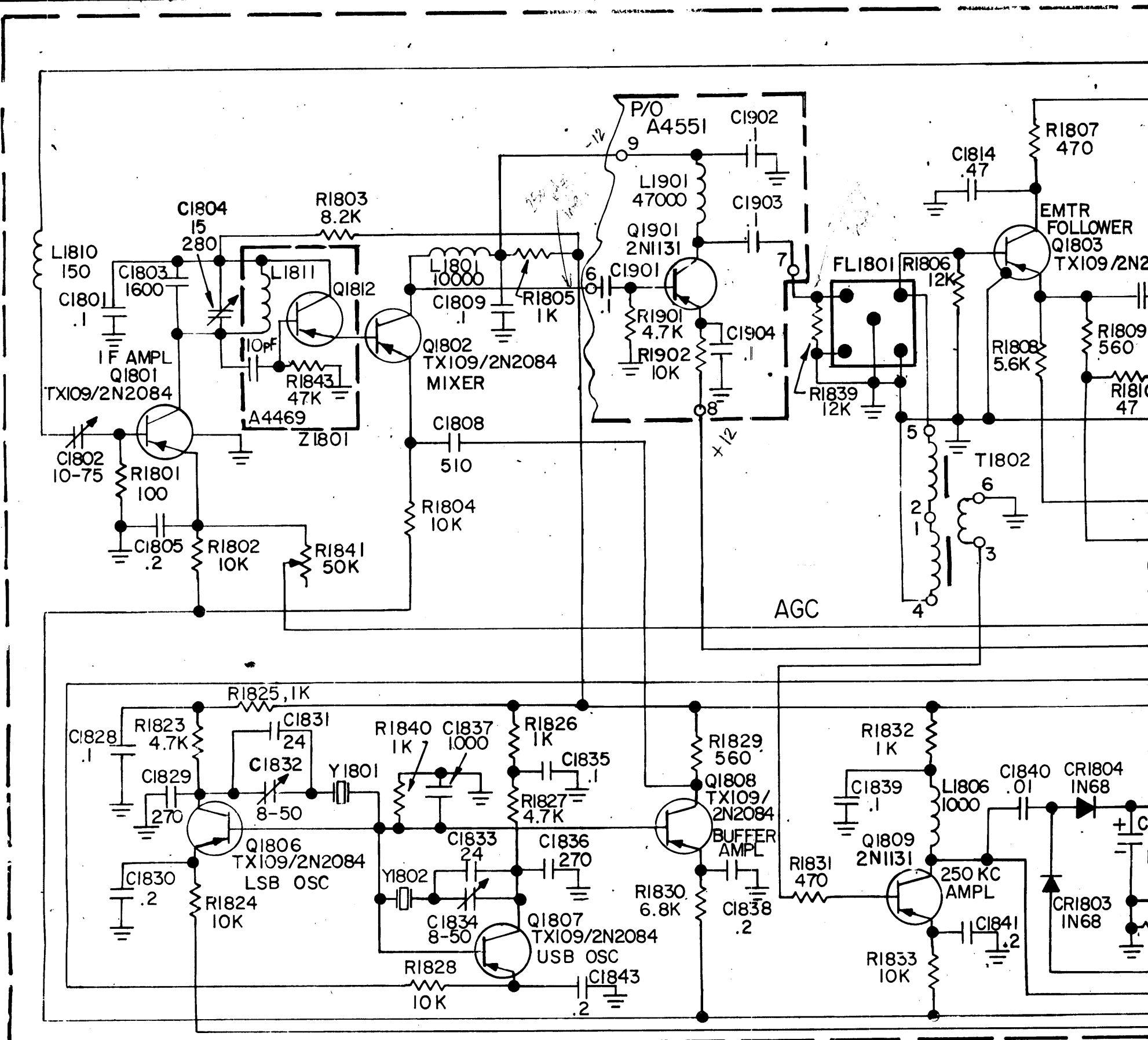

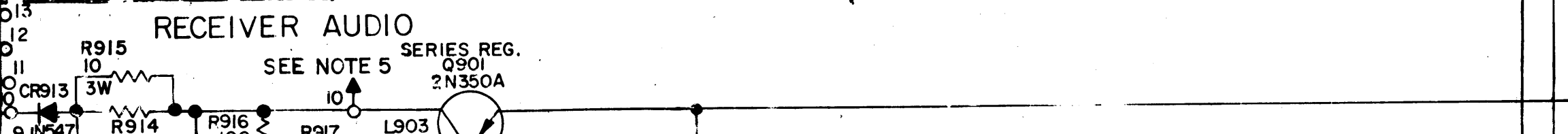
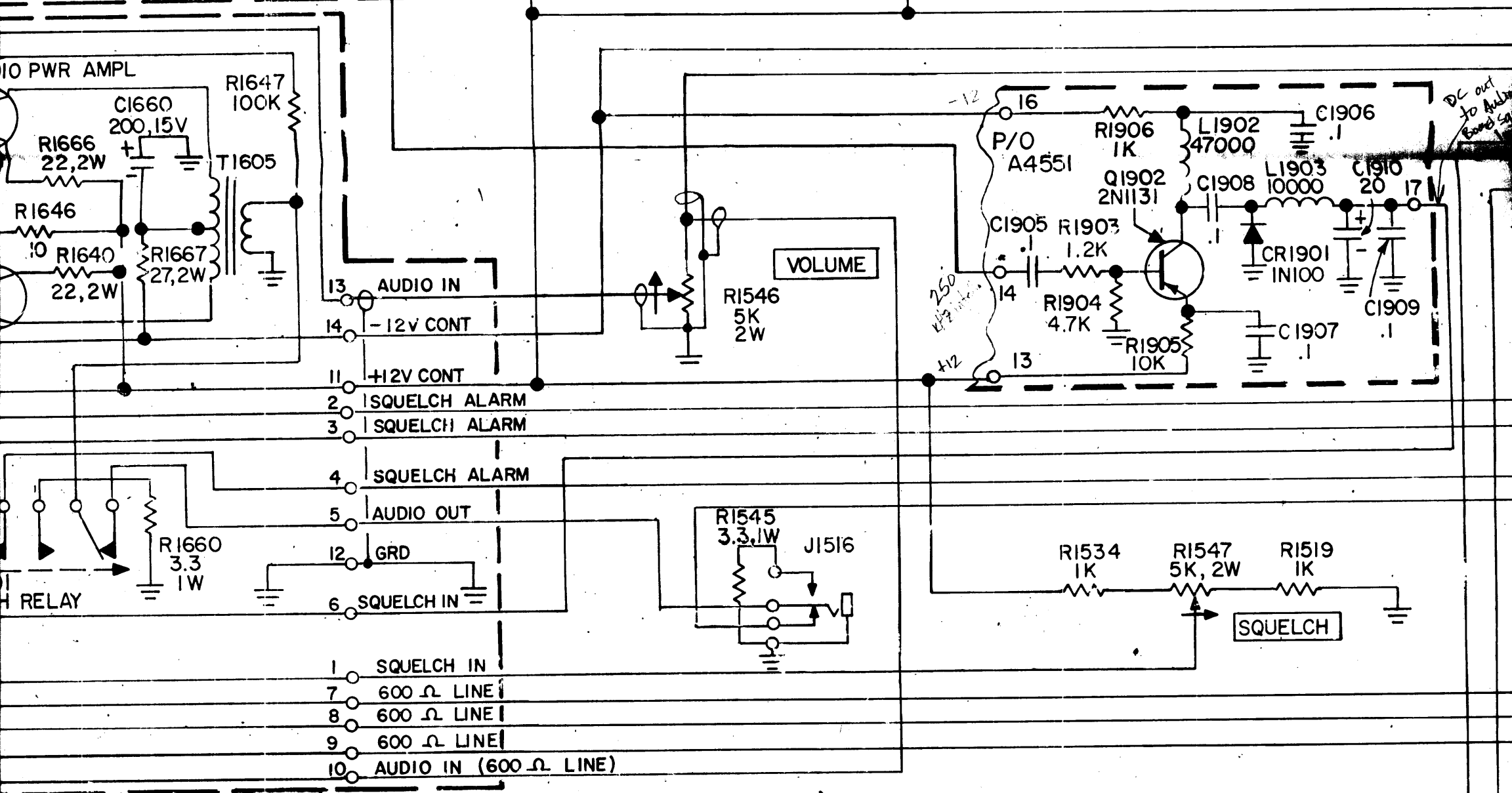
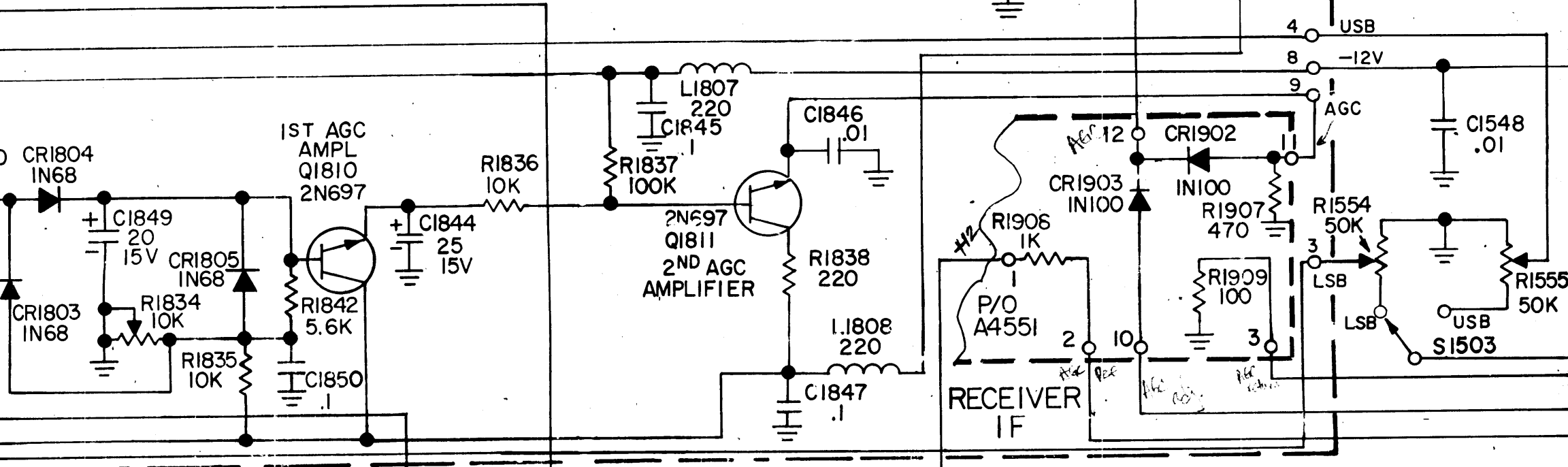
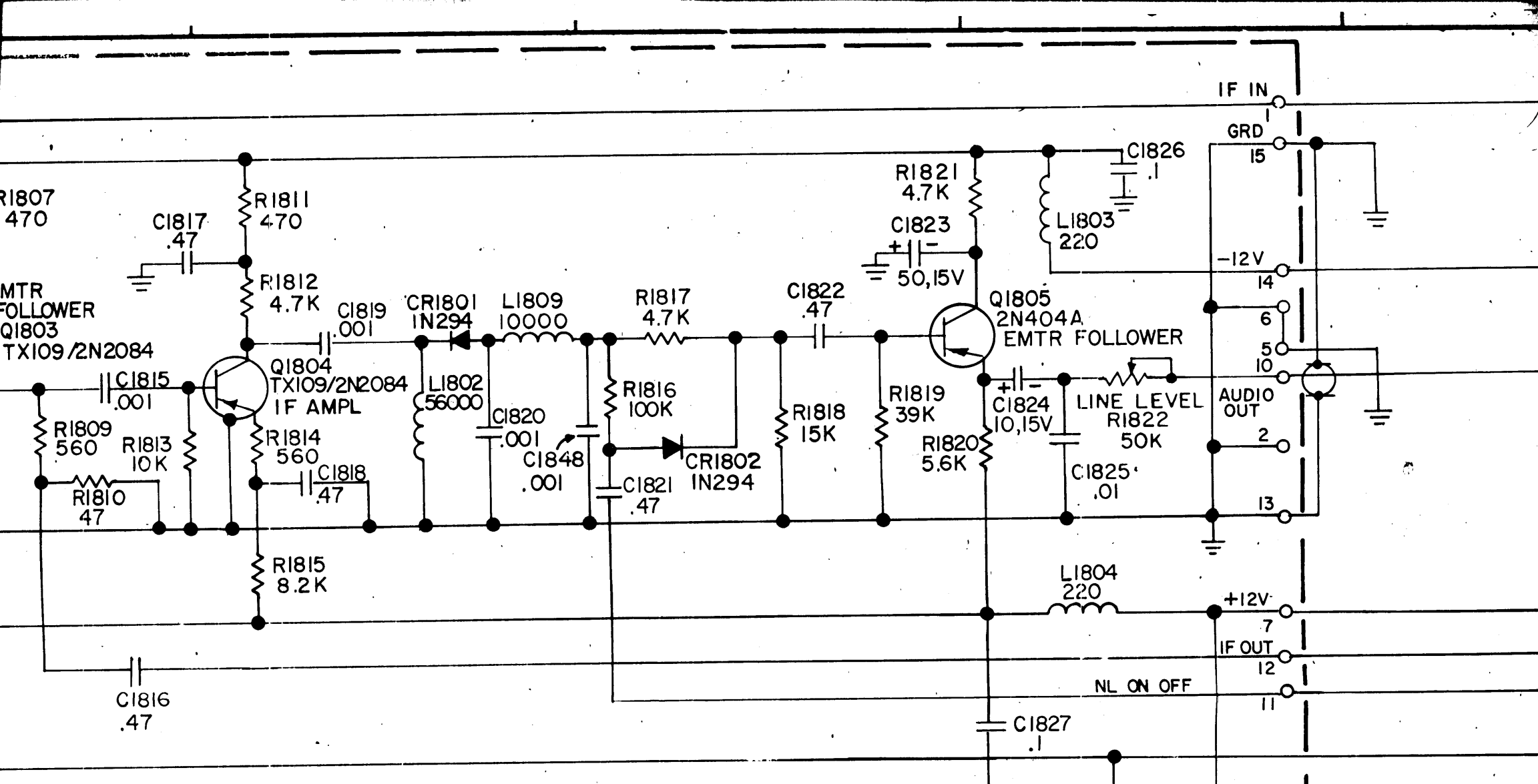

REVISIONS							
ZONE	SYM	DESCRIPTION	DATE	E.M.N. NO.	DRAFT	CHKD	APPD
	X	EXPERIMENTAL RELEASE	1-6-67	-	ALA		
	?	REVISED & UPDATED	12-1-18-67				

UNLESS OTHERWISE SPECIFIED:

ALL RESISTANCE VALUES ARE IN OHMS, 1/2 W.  
 ALL CAPACITANCE VALUES ARE IN MICROFARADS.  
 ALL INDUCTANCE VALUES ARE IN MICROHENRIES.

**NOTICE TO PERSONS RECEIVING THIS DRAWING**  
 THE TECHNICAL MATERIEL CORPORATION claims proprietary right in the material disclosed herein. This drawing is issued in confidence for engineering information only and may not be reproduced or used to manufacture anything shown herein without permission from THE TECHNICAL MATERIEL CORPORATION to the user. This drawing is loaned for mutual assistance and is subject to recall at any time.

Property of:  
 THE TECHNICAL MATERIEL CORPORATION  
 MAMARONECK, NEW YORK

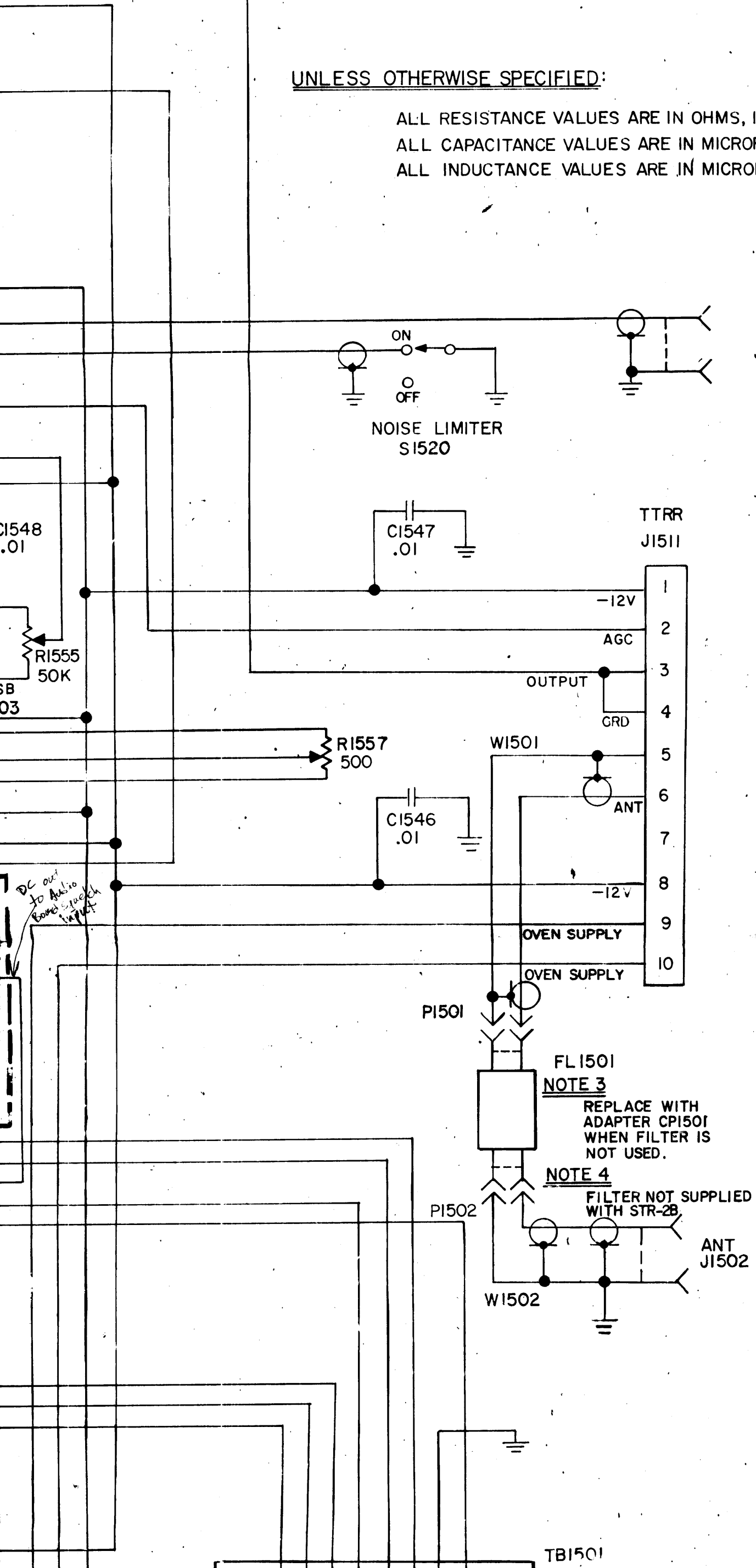

IF OUT  
 J1535

SERIES 900	
LAST	MISSING SYMBOLS
C913	C900 TO 906
CR915	CR900 ↑ 909
F907	F900 ↓ 906
J904	J900 ↓ 903
L903	L900 ↓ 901
Q901	
R917	R900 TO 908, R913
T902	T900, 901
1500 SERIES	
C1548	C1501 TO 1545
CPI501	DS1500
DS1501	J1500, 1501, J1503 TO 1510
FL1501	J1512 TO 1515
J1535	J1517 ↑ 1534
PI502	R1500 ↓ 1518, R1520 TO 1533
R1557	R1535 ↓ 1544, R1548 TO 1553
SI520	S1500 ↓ 1502, S1504 TO 1511
TBI501	S1514 TO 1519, S1513
W1502	TBI500
	CPI500
	FL1500
	PI500
	W1500
1600 SERIES	
C1661	C1600 TO 1638
K1601	C1640 TO 1645
Q1621	C1653 TO 1659
R1667	K1600
T1605	Q1600 TO 1612
	R1600 TO 1637
	R1648 TO 1650
	R1663, 1664
	T1600 TO 1602
1800 SERIES	
C1850	C1800, 1806, 1810 TO 1813
CR1808	CR1800
FL1801	FL1800
L1814	L1805
Q1814	Q1800
T1802	T1800, 1801
Y1802	Y1800
R1853	R1800, 1822
Z1801	Z1800
	C1807, C1842

K1272



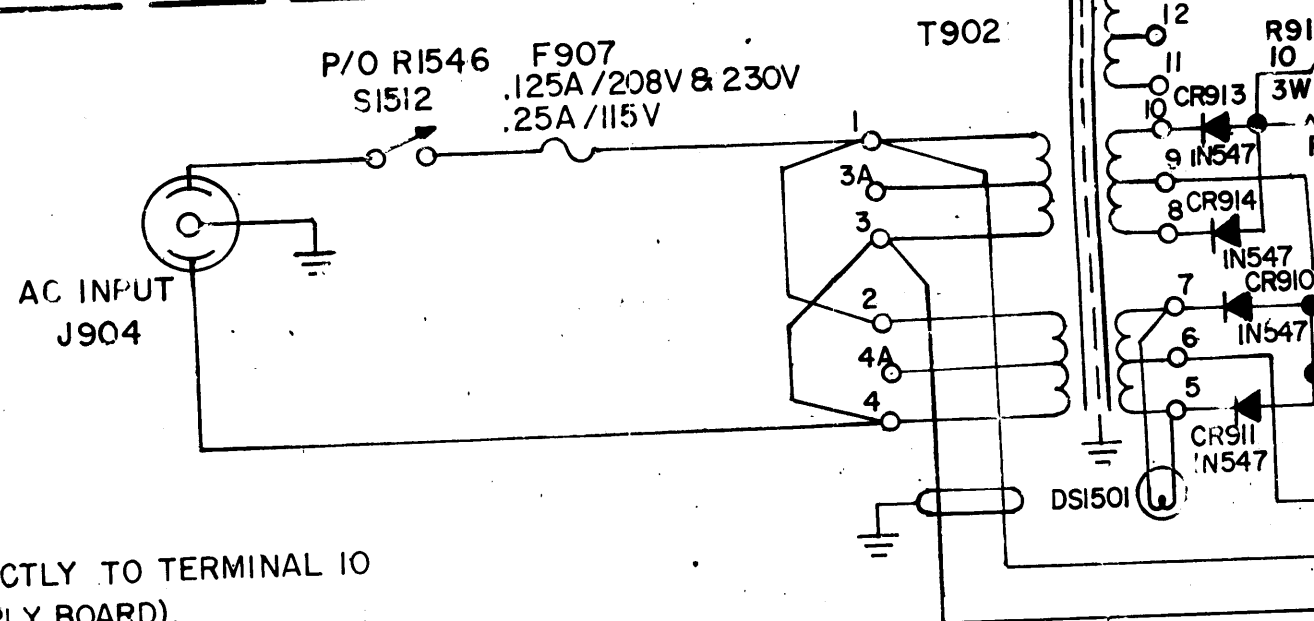
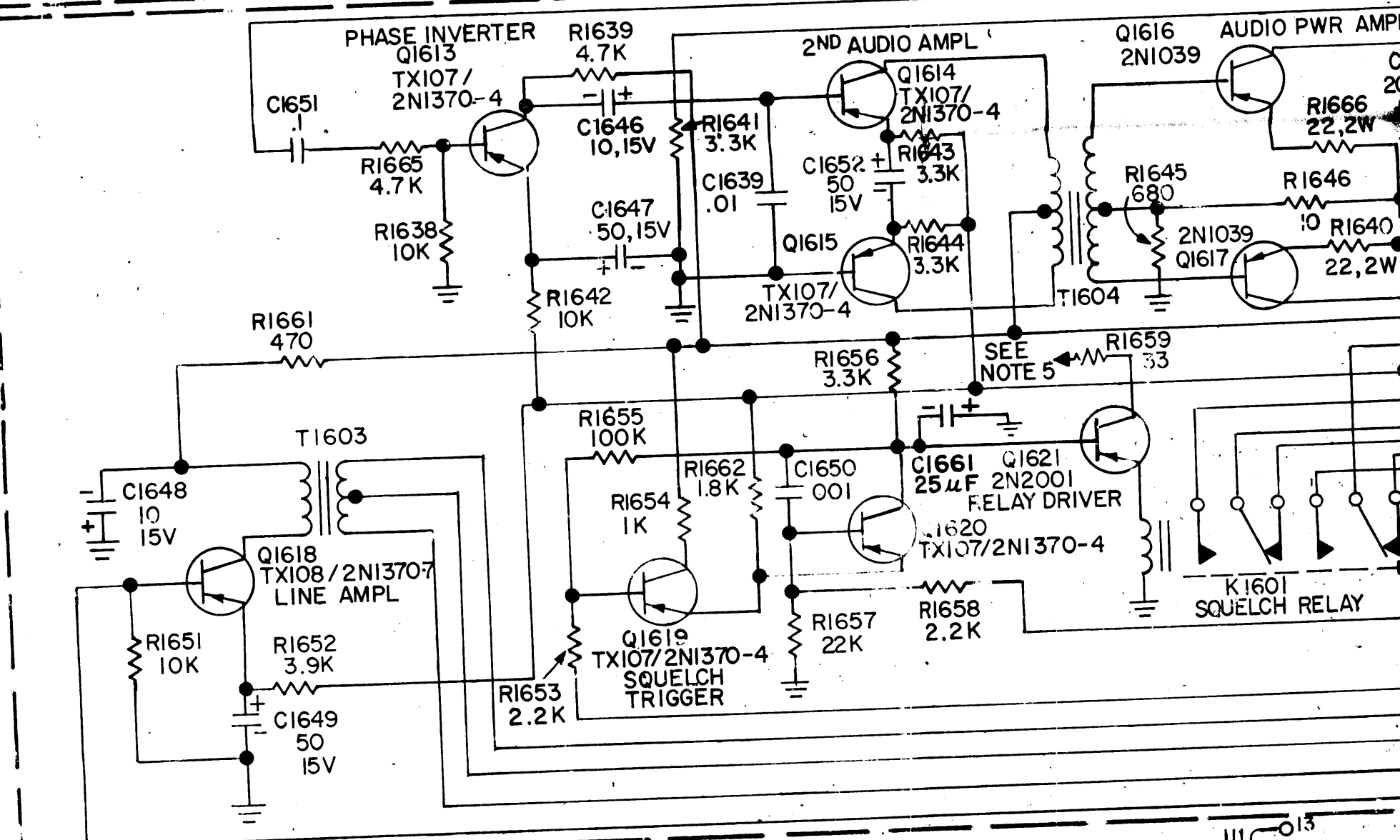
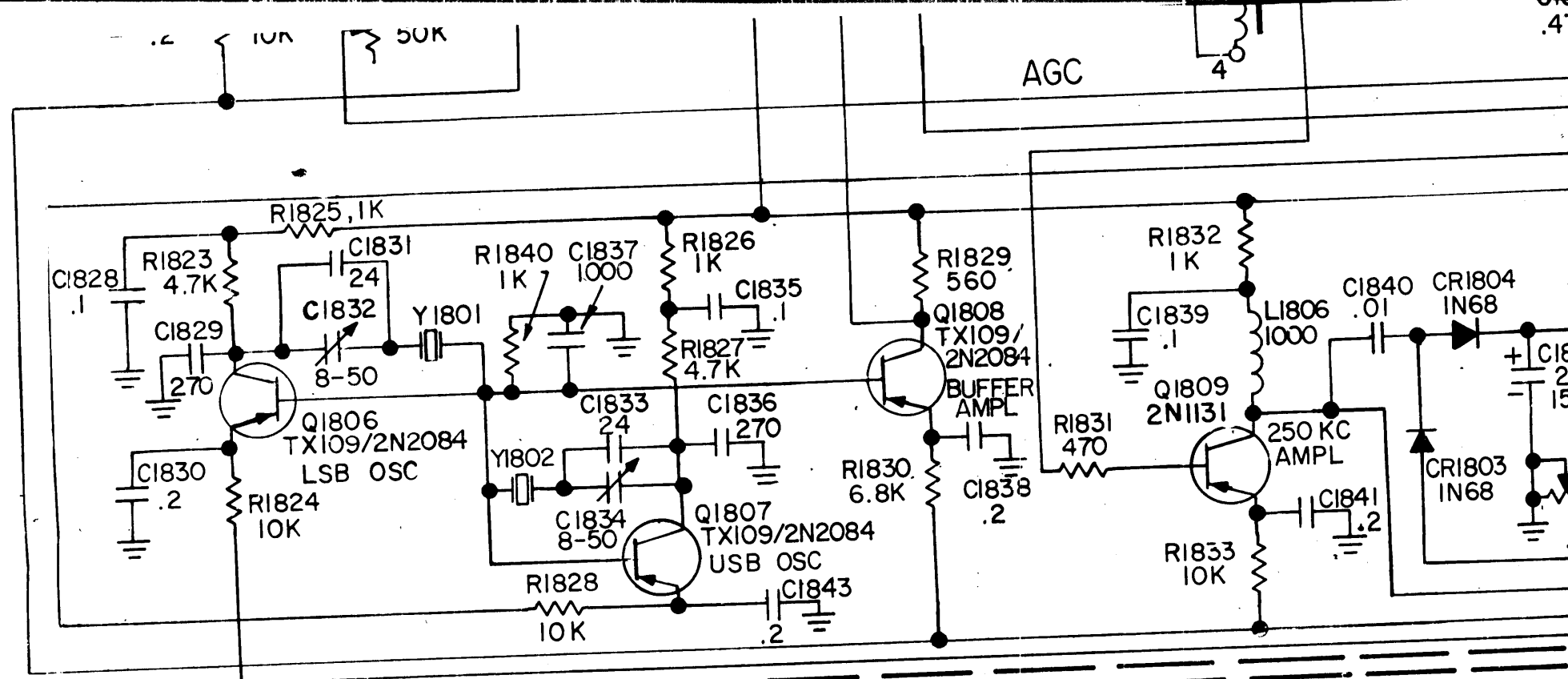

**NOTE 5:**  
THIS POINT WIRED DIRECTLY TO TERMINAL 10 ON A3153 (POWER SUPPLY BOARD).

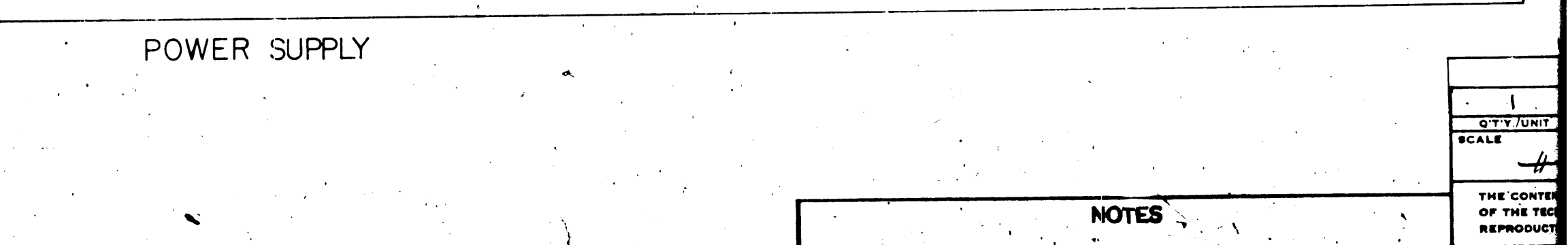
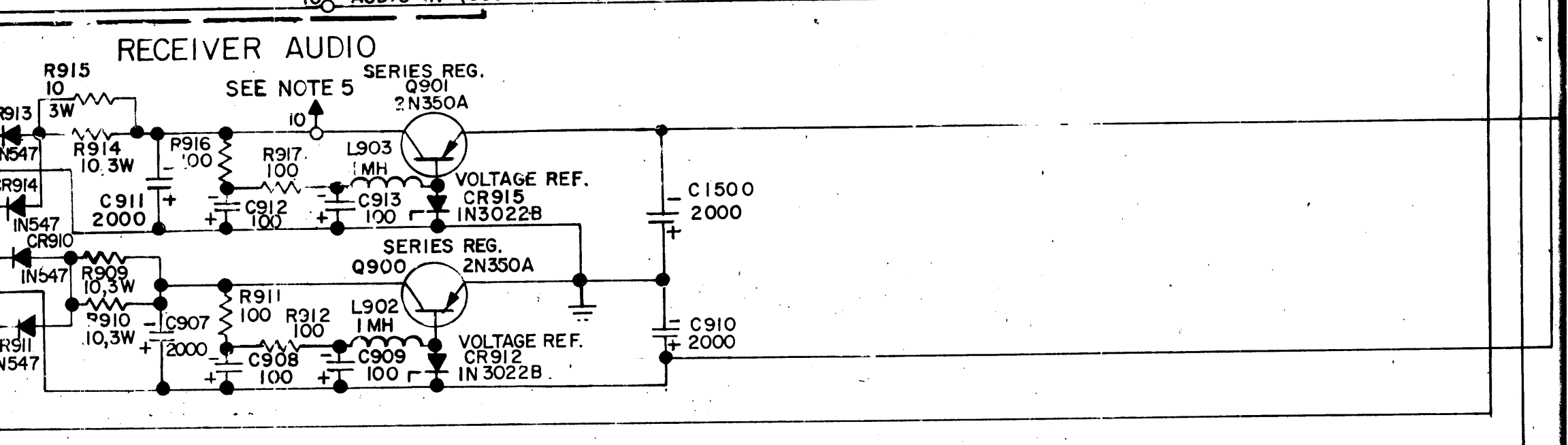
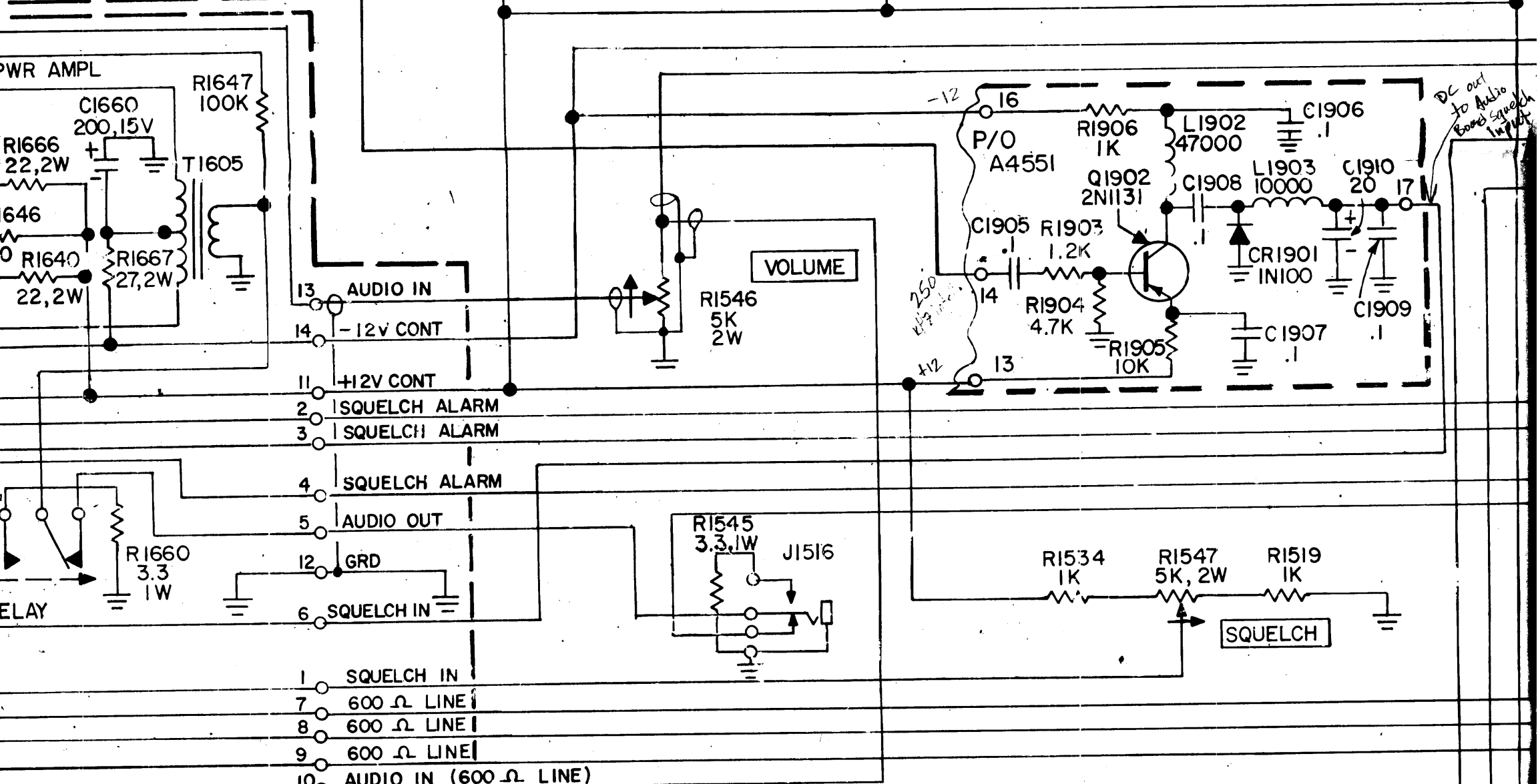
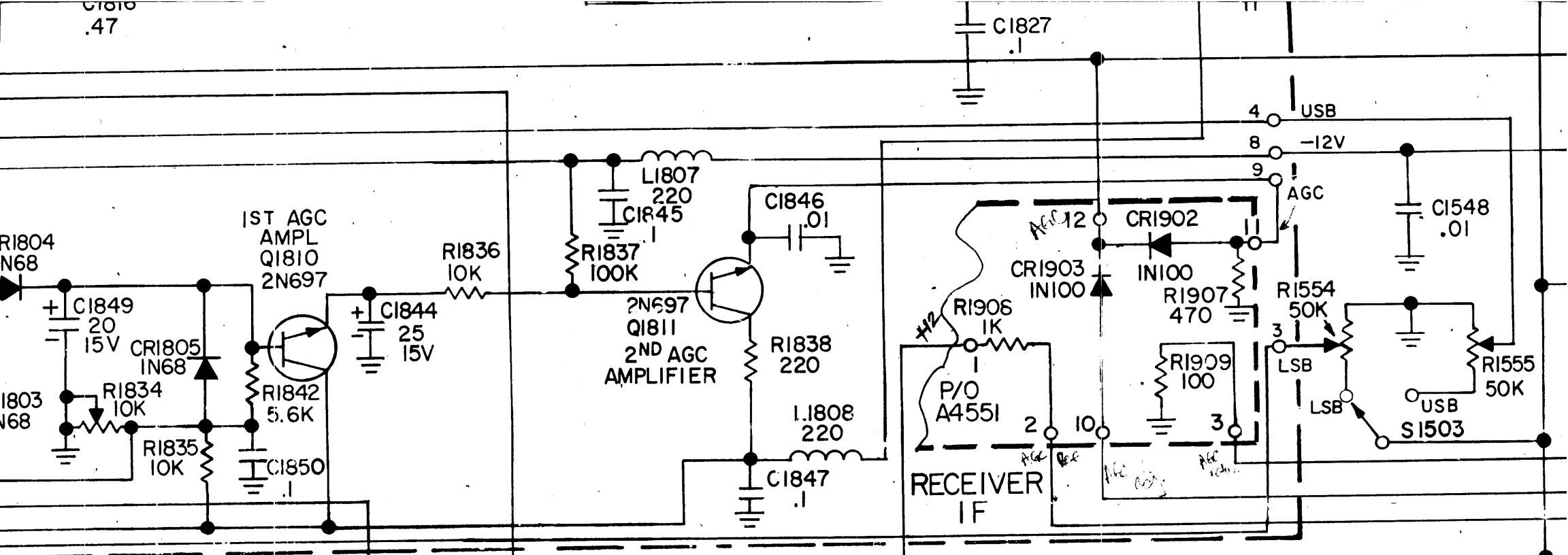

QTY/UNIT	SCALE
1	4

NOTES

THE CENTER OF THE TECH REPRODUCE

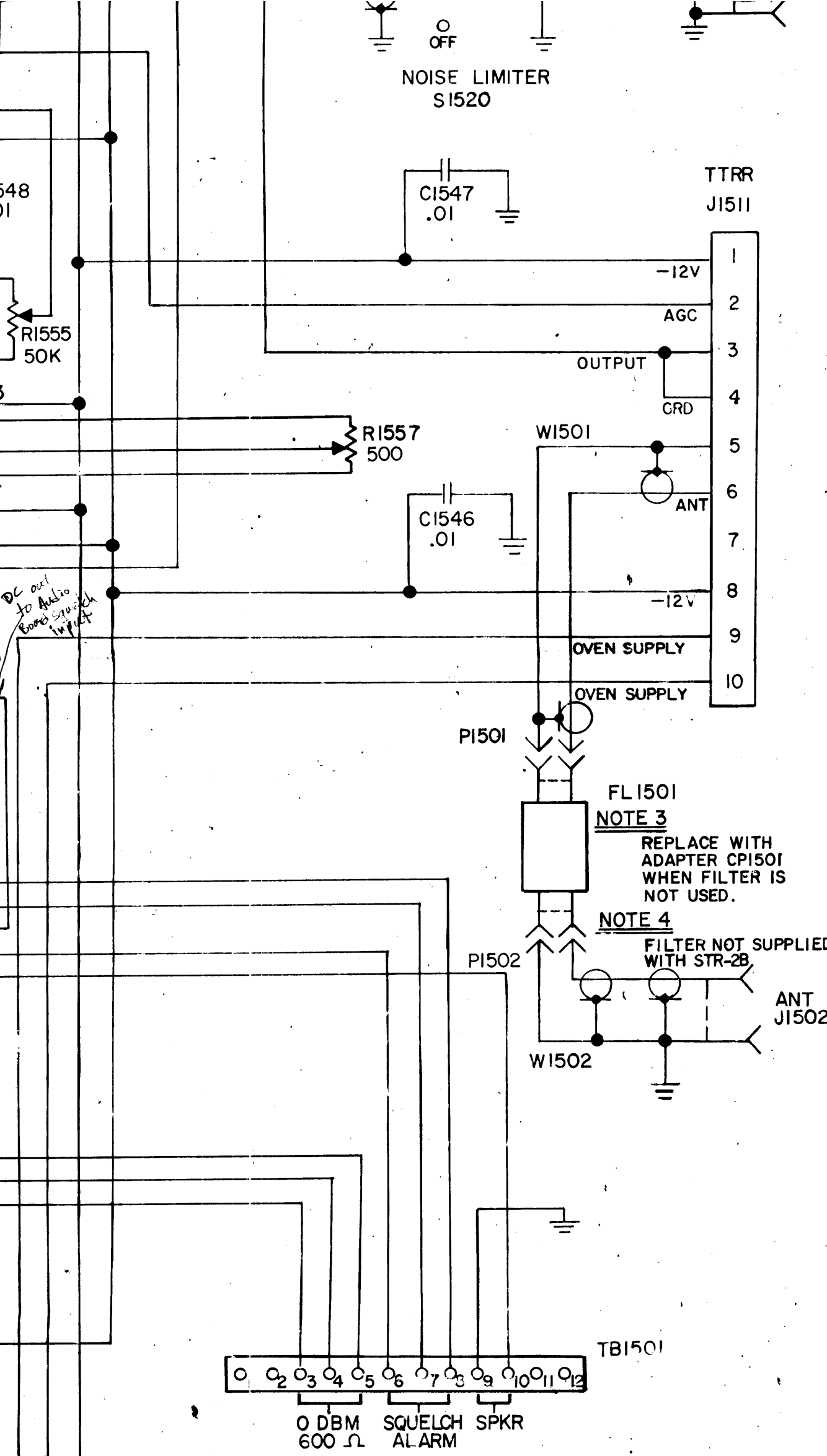

SERIES 900	
LAST	MISSING SYMBOLS
C913 CR915 F907 J904 L903 Q901 R917 T902	C900 TO 906 CR900 909 F900 906 J900 903 L900 901 R900 TO 908, R913 T900, 901
1500 SERIES	
C1548 CPI501 DS1501 FL1501 J1535 PI502 R1557 S1520 TB1501 W1502	C1501 TO 1545 DS1500 J1500, 1501, J1503 TO 1510 J1512 TO 1515 J1517 1534 R1500 1518, R1520 TO 1533 R1535 1544, R1548 TO 1553 S1500 1502, S1504 TO 1511 S1514 TO 1519, S1513 TB1500 CPI500 FL1500 PI500 W1500
1600 SERIES	
C1661 K1601 Q1621 R1667 T1605	C1600 TO 1638 C1640 TO 1645 C1653 TO 1659 K1600 Q1600 TO 1612 R1600 TO 1637 R1648 TO 1650 R1663, 1664 T1600 TO 1602
1800 SERIES	
C1850 CR1808 FL1801 L1814 Q1814 T1802 Y1802 R1853 Z1801	C1800, 1806, 1810 TO 1813 CR1800 FL1800 L1805 Q1800 T1800, 1801 Y1800 R1800, 1822 Z1800 C1807, C1842
1900 SERIES	
C1910 CR1903 L1903 Q1902 R1909	

K1272

REQD	ITEM	PART NUMBER	DESCRIPTION	SYMBOL
POSE LIST OF MATERIAL CK-106-1				
MATERIAL			THE TECHNICAL MATERIEL CORP. MAMARONECK, NEW YORK	
FINISH			TITLE DIAGRAM, SCHEMATIC MODEL STR-2Y	
UNLESS OTHERWISE SPECIFIED DIMENSIONS ARE IN INCHES AND INCLUDE CHEMICALLY APPLIED OR PLATED FINISHES			DRAWN H. AUSTIN	DATE 12-27-66
DECIMALS X ± .05 XX ± .01 XXX ± .005			CHECKED	DATE
TOLERANCES			ELECT. DES.	DATE
FRACTIONS ± 1/64 ANGLES ± 0° 30'			MECH. DES.	DATE
			SHEET CK1272	
			REV. LTR.	

THE CONTENTS OF THIS DRAWING ARE THE EXCLUSIVE PROPERTY OF THE TECHNICAL MATERIEL CORP. ITS UNAUTHORIZED USE OR REPRODUCTION IN WHOLE OR IN PART IS STRICTLY FORBIDDEN.