



Publication: 203004A

Issue Date: February 1991

**MASTER COPY**  
**DO NOT DESTROY**

## **TECHNICAL MANUAL**

for

### **Rhombic Terminal Unit**

### **RTB Series**

*Models RTB-[1][3][4][5][6][9][10][11][12][13][15]*

**The Technical Materiel Corporation**  
700 Fenimore Road  
Mamaroneck, New York 10543-0142 U.S.A.

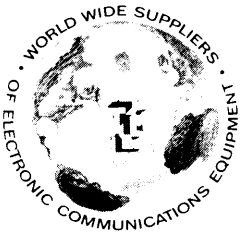

Publication: 203004A

Issue Date: February 1991

# **TECHNICAL MANUAL**

**for**

## **Rhombic Terminal Unit**

### **RTB Series**

***Models RTB-[1][3][4][5][6][9][10][11][12][13][15]***

**THE TECHNICAL MATERIEL CORPORATION**  
COMMUNICATIONS ENGINEERS

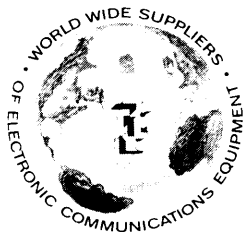

**PLEASE READ THIS FIRST**

Dear **TMC** product user:

Thank you for purchasing the TMC Model RTB series of Rhombic Terminal Units. This series consists of several models that provide stable resistive terminations for rhombic and sloping-V antennas to increase their efficiency. The complete series operates in the DC to 30MHz frequency range in either a balanced or unbalanced configuration.

The terminal unit is described in detail in the enclosed technical manual. As appropriate, application notes have also been included. These publications provide important information about using TMC equipment. Please read them.

Since the RTB is used with antenna systems that may require coaxial mating connectors and cables to operate properly, a catalog on TMC's connector products is included. If you need additional data or some specific technical information, please give our Customer Service a call at (914) 698-4800 or return the business reply form provided in this package. Our FAX (facsimilie) number is (914) 698-4805.

If you are missing any items, please contact TMC directly or through your local TMC sales office.

Thank you for selecting the TMC Model RTB receiving antenna terminal unit for your application.

***The Technical Materiel Corporation***  
Product Marketing

**THE TECHNICAL MATERIEL CORPORATION**  
COMMUNICATIONS ENGINEERS

# Warranty

The Technical Materiel Corporation, hereinafter referred to as TMC, warrants the equipment - except electron tubes, semi-conductor devices, fuses, lamps, batteries, and articles made of glass or other fragile or expendable materials - purchased hereunder to be free from defect in workmanship and materials under normal use and service, when used for the purposes for which the same is designed, for a period of ONE YEAR from the date of delivery FOB factory. TMC further warrants that the equipment will perform in a manner equal to or better than published technical specifications as amended by any additions or corrections thereto accompanying the formal equipment offer.

TMC will replace or repair any such defective items, FOB factory, which may fail within the stated warranty period, provided:

- Any claim of defect under this warranty is made within sixty (60) days after discovery thereof and that inspection by TMC, if required, indicates the validity of such claim to TMC's satisfaction;
- The defect is not the result of damage incurred in shipment from or to the factory;
- The equipment has not been altered in any way either as to design or use whether by replacement parts not supplied or approved by TMC, or otherwise; and
- Any equipment or accessories furnished but not manufactured by TMC, or not of TMC design shall be subject only to such adjustments as TMC may obtain from the supplier thereof.

At TMC's option, any defective part or equipment which fails within the warranty period shall be returned to TMC's factory for inspection, properly packed with shipping charges prepaid and the TMC RETURN AUTHORIZATION number clearly marked on the package. Electron tube warranty claims should be made directly to the manufacturer of such tubes since tubes furnished by TMC bear only the manufacturer's warranty.

No warranties, expressed or implied, other than those specifically set forth herein shall be applicable to any equipment manufactured or furnished by TMC and the foregoing warranty shall constitute the purchaser's sole right and remedy. In no event does TMC assume any liability for consequential damages, or for loss, damage or expense directly or indirectly arising from the use of such equipment, or any inability to use them either separately or in combination with other equipment or materials or from any other cause.

All inquiries should be directed to the following:

## **THE TECHNICAL MATERIEL CORPORATION**

700 Fenimore Road

Mamaroneck, New York 10543 U.S.A.

Telephone 914-698-4800 \* Facsimile (FAX) 914-698-4805

**THE CONTENTS AND INFORMATION CONTAINED IN THIS INSTRUCTION MANUAL IS PROPRIETARY TO THE TECHNICAL MATERIEL CORPORATION TO BE USED AS A GUIDE TO THE OPERATION AND MAINTENANCE OF THE EQUIPMENT FOR WHICH THE MANUAL IS ISSUED AND MAY NOT BE DUPLICATED EITHER IN WHOLE OR IN PART BY ANY MEANS WHATSOEVER WITHOUT THE WRITTEN CONSENT OF THE CORPORATION.**

## **RECORD OF REVISIONS**

REVISION 01
REVISION 02
REVISION 03
REVISION 04
REVISION 05
REVISION 06
REVISION 07
REVISION 08

# Table of Contents

---

<b>Section 1</b>	<b>General Description</b>
1.1	Functional Description
1.2	Physical Description
1.3	Technical Specifications
1.4	RTB Product Group
<b>Section 2</b>	<b>Installation</b>
2.1	Initial Inspection
2.2	Electrical Installation
2.3	Mechanical Installation
<b>Section 3</b>	<b>Principles of Operation</b>
3.1	General
3.2	Operation
<b>Section 4</b>	<b>Maintenance</b>
4.1	General
4.2	Preventive Maintenance
4.3	Troubleshooting
4.4	Repair
<b>Section 5</b>	<b>Parts List</b>

## **List of Illustrations**

---

<b>Overleaf</b>	<b>Photographic print of RTB Terminal Unit</b>
<b>Figure 1.1</b>	<b>Typical Rhombic Antenna System</b>
<b>Figure 2.1</b>	<b>Installation Mounting Drawing</b>
<b>Figure 3.1</b>	<b>Simplified Schematic Diagram</b>
<b>Figure 5.1</b>	<b>Component Location</b>

## **List of Tables**

---

<b>Table 5.1</b>	<b>Replacement Spare Parts List</b>
------------------	-------------------------------------

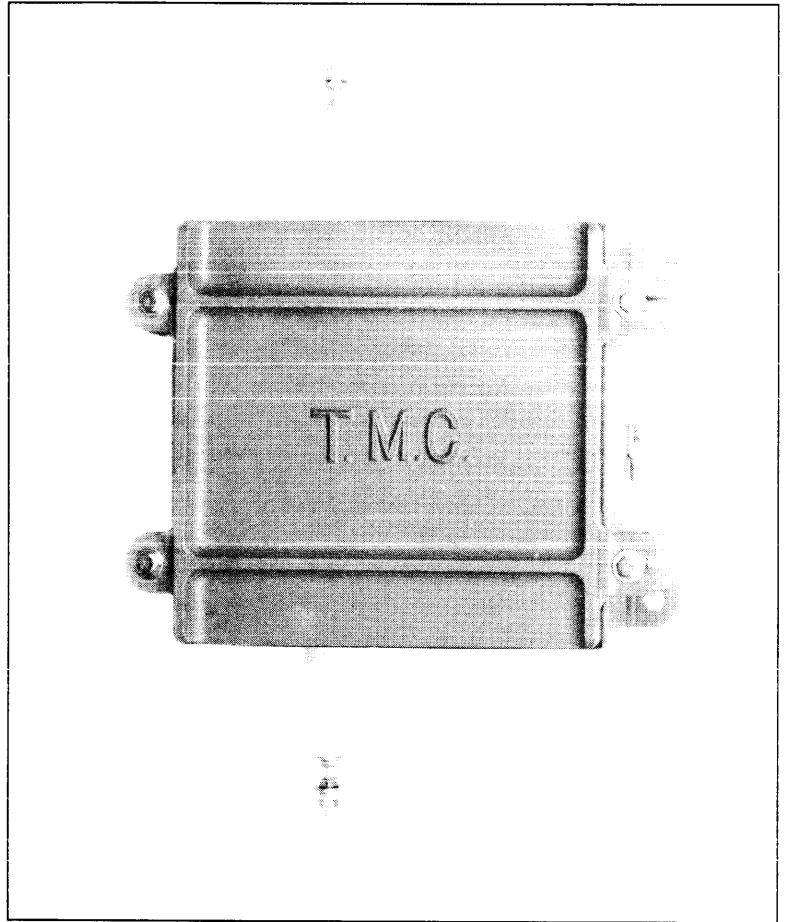

**Model RTB (Typical)**

*One unbalanced or unbalanced RF Terminal*

The designation "RTB" is used herein to refer interchangeably to all models in the terminal unit series. Any variations to this convention are noted.



# Section 1 - General Description

---

## 1.1 Functional Description

### 1.1.1 Overview

The Rhombic Terminal Unit, Model RTB, provides rugged and proper resistive terminations for rhombic and sloping-V antennas. Use of the RTB series also increases efficiency and provides uniform antenna characteristics due to its environmental shielding. Figure 1.1 illustrates a typical rhombic antenna system employing an RTB terminating unit at one end and a TMC Model RAC antenna coupler at the other end.

### 1.1.2 Major Assemblies

The RTB consists of non-inductive resistors mounted in weatherproof aluminum cases designed to be pole mounted by means of four heavy cast mounting flanges. For mounting and outline dimensions, refer to Figure 2.1.

### 1.1.3 Electrical Characteristics

The resistors used in the RTB are plug-in ferrule type for ease of replacement. Internal spark gaps are also provided for protection against lightning and static charges. See the overleaf photograph and Figure 5.1 for a front and inside view of a typical Rhombic Terminal Unit.

### 1.1.4 Non-Standard Models

The standard models listed in Section 1.4 are the most popular among the thousands of users TMC has supplied over the years. Other varieties of the RTB, however, are available through our engineering group. Different impedances and grounding schemes are possible by varying the interconnect of the resistor assemblies.

## 1.2 Physical Description

### 1.2.1 Weathertight Case Construction

The RTB circuitry is mounted on a rigid plate inside a weathertight case that is sealed with a firm, rubber gasket and protected from moisture damage with packets of dessicant.

### 1.2.1 External Mounting

The RTB is designed for mounting on a pole carrying the terminals of a receiving antenna, such as a single or nested rhombic. It can also be supplied for bulkhead mounting with the addition of a steel plate bolted to the RTB case.

## 1.3 Technical Specifications

**Frequency Range** DC to 30 MHz

**Termination Impedance (Resistance)** Balanced or unbalanced, 50 to 700 ohms depending on the model selected. Other balanced and unbalanced ratings are available. (See Section 1.4 for selection)

**Ground Connection** Provided at the side or bottom of the case.

**Input Terminals** Two ceramic insulators on 16-inch centers for a rhombic antenna configuration. One ceramic insulator for a sloping-V antenna.

**Mean-Time-Between-Failure (Calculated)** Nominally 40,000 hours depending on severity of the operating environment.

### Operating Features

**Cooling** Convection, no fans or moving parts

**Mounting** Pole mounting by means of four heavy cast mounting flanges. (See Figure 2.1)

**Ambient Conditions** -30°C to +50°C; 100% R.H. Storage -30°C to +80°C

**Size and Weight** 9H x 9W x 5D inches (22.9H x 22.9W x 12.7D cm), 18lbs

### Special Features

**Safety** Front-end protection, preventing circuit failure from lightning and static discharges.

**Components and Construction** Totally solid state circuits mounted to a weatherproof, cast aluminum alloy case. External hardware is stainless steel. Bulkhead mounting is optionally available.

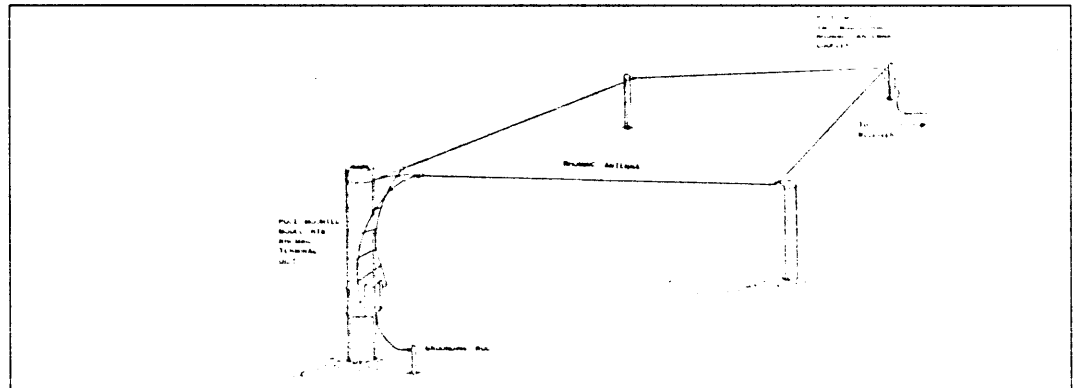

**Figure 1.1 Typical Rhombic Antenna System**

## 1.4 RTB Product Group

<b>RTB-1</b>	<b>Rhombic Terminal Unit</b>	<b>700-ohm balanced</b>
<b>RTB-3</b>	<b>Rhombic Terminal Unit</b>	<b>280-ohm balanced CTG*</b>
<b>RTB-4</b>	<b>Rhombic Terminal Unit</b>	<b>700-ohm balanced CTG</b>
<b>RTB-5</b>	<b>Rhombic Terminal Unit</b>	<b>600-ohm balanced CTG</b>
<b>RTB-6</b>	<b>Rhombic Terminal Unit</b>	<b>500-ohm unbalanced</b>
<b>RTB-9</b>	<b>Rhombic Terminal Unit</b>	<b>650-ohm balanced CTG</b>
<b>RTB-10</b>	<b>Rhombic Terminal Unit</b>	<b>400-ohm unbalanced G*</b>
<b>RTB-11</b>	<b>Rhombic Terminal Unit</b>	<b>650-ohm balanced CTG**</b>
<b>RTB-12</b>	<b>Rhombic Terminal Unit</b>	<b>425-ohm balanced</b>
<b>RTB-13</b>	<b>Rhombic Terminal Unit</b>	<b>400-ohm balanced CT</b>
<b>RTB-15</b>	<b>Rhombic Terminal Unit</b>	<b>50-ohm unbalanced G</b>

\* Legend: CTG = Center-tapped and grounded.  
CT = Center-tapped only.  
G = Grounded only.

\*\* The RTB-11 is grounded through 280 ohms.

To order, specify model. Example: RTB-5.

## Section 2 - Installation

---

### 2.1 Initial Inspection

#### 2.1.1 General

Every RTB undergoes a thorough testing and calibration prior to shipment. Upon receipt of the unit, check the packing case and its contents for obvious damage. Unpack the equipment carefully to reduce the risk of damage and to avoid misplacing any loose items.

#### 2.1.2 Damage By Carrier

With respect to equipment damage for which the carrier is liable, TMC will assist in describing methods of repair as well as furnishing replacement parts.

### 2.2 Electrical Installation

#### 2.2.1 General

The RTB is shipped in one carton or box crate (depending on packaging requirements) and is completely assembled at the time of delivery. It has been factory tested and arrives ready for immediate operation. No preliminary adjustments are necessary other than the connection of antenna and ground leads.

#### 2.2.2 Primary Power

All components used in the RTB are passive. The RTB does not require the application of external power or tuning adjustment for proper operation.

#### 2.2.3 External Connections

The following external connections must be made to the RTB after it has been installed:

##### Antenna

For rhombic antennas, connect the two antenna terminating leads to the two ceramic input terminal of the RTB. Only one connection from the antenna is required when using the RTB with a sloping-V antenna. Be careful not to break or damage the insulators. (See Figure 2.1).

##### Grounding

The ground connection, located on the side or bottom of the RTB case, must be securely connected, by means of an adequate grounding cable, to a permanent ground. This can be accomplished by using a ground rod or a series of ground rods imbedded into the earth. The length of the ground rods is dependant on the prevailing soil or earth conditions.

### 2.2.4 Performanc Check

When the appropriate connections have been made to the RTB, a quick continuity check with an ohmmeter should be made. The steps required for this test are described in Section 4.2. No further checks are required; the RTB is ready for immediate use.

### 2.3 Mechanical Installation

The RTB is typically mounted to a pole adjacent to the base of the antenna. Figure 2.1 shows dimensions and information for a typical pole mounting. The case size and mounting holes are the same for all RTB units.

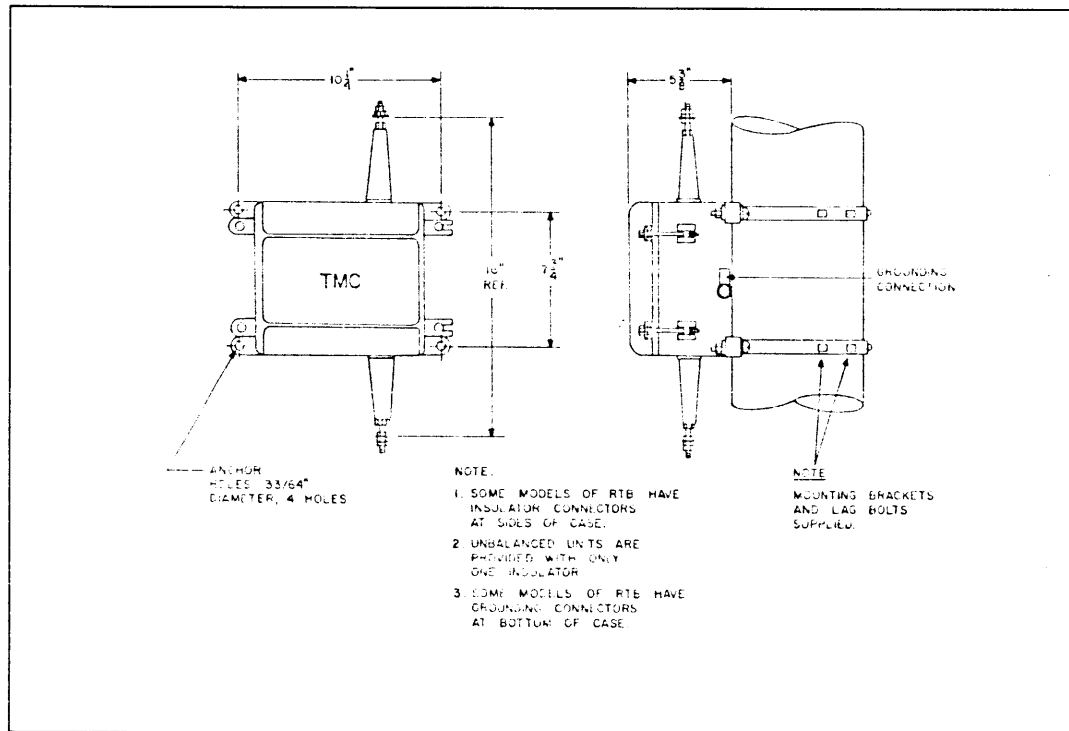

**Figure 2.1** Installation Mounting Drawing

## Section 3 - Principles of Operation

### 3.1 General

The primary purpose of the terminating impedance of a rhombic antenna is to produce a sharp, unidirectional radiation pattern. The Rhombic Terminal Unit, Model RTB, provides the proper termination impedance by use of a series of non-inductive resistors.

### 3.2 Operation

Undesirable capacitance and resonance effects may result from metallic insulators and supporting elements used in the antenna system. The RTB units minimize these undesirable effects by properly spacing the terminal connectors and by connecting the terminating resistors in series. Uniform antenna termination impedance is also ensured by environmental shielding of the termination network in a weatherproof case.

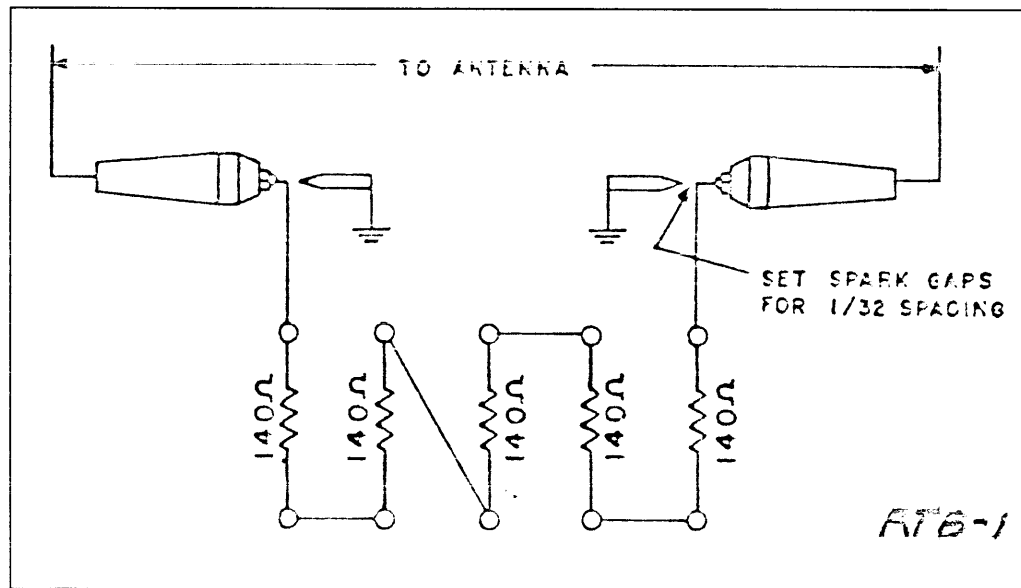

Figure 3.1 Simplified Schematic Diagram

## Section 4 - Maintenance

---

### 4.1 General

#### 4.1.1 Simplicity of Design

Due to the simplicity of design and operation of the RTB unit, maintenance requirements are minimal.

#### 4.1.2 Component Location

For aid in the location of components, refer to Figure 5.1.

### 4.2 Preventive Maintenance

#### 4.2.1 General Cleaning Methods

Preventive maintenance for the RTB consists of routine functions such as visual inspection and cleaning. Periodic cleaning is recommended as dust may build up on components, reducing the efficiency of the terminal unit and possibly causing circuit failure. To facilitate cleaning the unit, use a vacuum cleaner or a low-pressure filtered compressed-air supply. Otherwise, the RTB normally requires no maintenance other than a check to see that all external and internal connections are properly tightened.

#### 4.2.2 Visual Check

A simple visual check of the unit when it is opened up for servicing or cleaning with often reveal potential trouble spots and thereby reduce downtime due to component failure. Signs of trouble may be found in discoloration and damaged wiring. Any deteriorating component should be replaced immediately. All hardware should be checked for tightness during preventive maintenance inspections.

#### 4.2.3 Dehydrant Change

Change the dehydrant every six months or sooner, if required. Where a new supply of dehydrant is not available, the old may be reactivated by baking the dessicant package in an oven for one hour at 200 degrees Fahrenheit (200°F).

#### 4.2.4 Measurements

A quick continuity and resistance check can easily be made with an ohmmeter. Figure 3.1 is a simplified diagram that illustrates a typical interconnect of the resistor elements. Each RTB is supplied with a similar diagram that is mounted directly to the inside cover of the RTB case. Since there are several different types of terminal units, this latter diagram should be used when troubleshooting the unit.

### **4.3 Troubleshooting**

When trouble occurs in a receiving system during operation, several areas must be checked, namely the antenna, the RTB terminal unit, the balanced-to-unbalanced antenna coupler, the feed line or coaxial cable run, and the receiving equipment. A simple continuity check is required to determine how well the RTB is functioning. In addition, all connections to the RTB should be securely fastened.

### **4.4 Repair**

#### **4.4.1 General Method**

Repair work generally consists of replacing the defective component. The following cautions should be observed:

- Make sure the replacement component is an exact duplicate of the defective one.
- Place any new component in the same location as the component it replaces. The dressing of any wire runs should not be altered.

#### **4.4.2 Adjustments**

The RTB terminal unit does not require any adjustment since all components are of fixed values. A simple continuity check will determine whether proper connections were made.



## Section 5 - Parts List

**Table 5.1 - Replacement Spare Parts List**

(Refer to Figure 5.1 for CALL-OUT of parts)

Item	TMC Part Number	Description	Model*	Quantity		
1	RR133-1	Term Res	RTB-10 & 13	4 each		
	RR133-1		RTB-12	1 each		
	RR133-1		RTB-15	2 each		
	RR133-2		RTB-1	5 each		
	RR133-2		RTB-3 & 11	2 each		
	RR133-3		RTB-5	4 each		
	RR133-3		RTB-6 & 12	1 each		
	RR133-3		RTB-9 & 11	2 each		
	RR133-4		RTB-6, 9 & 11	2 each		
	RR133-4		RTB-12	1 each		
	RR115-175		RTB-4	4 each		
	2		BM212	Hardware Kit	All	1 each
	3		A102 (Rhombic)	Insulator Assy	All	2 each
A102 (Sloping-V)		Insulator Assy	All	1 each		
4	GA103	Cover Gasket	All	1 each		

\* One model may contain several types of resistors.

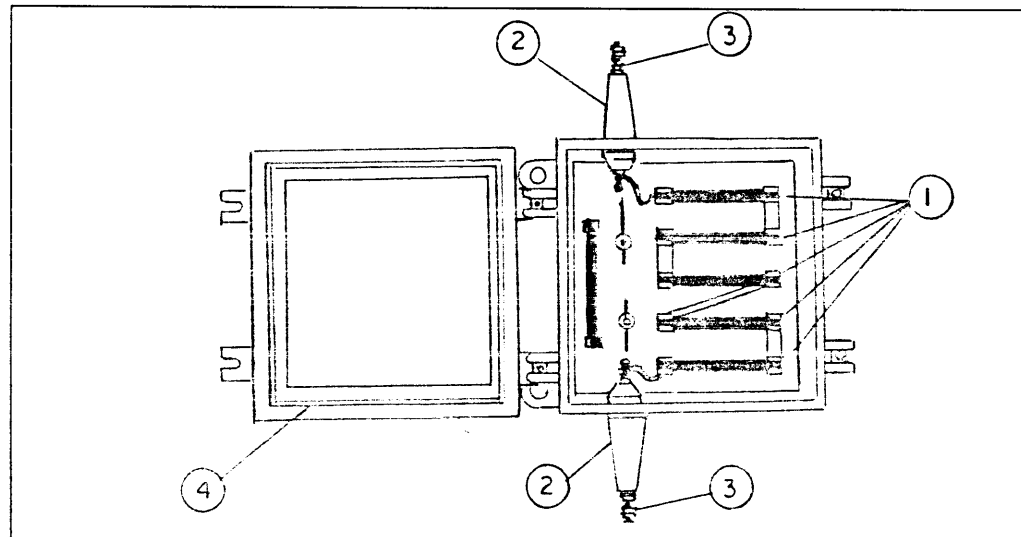

**Figure 5.1 Component Location, RTB Series**

NOTICE - WHEN GOVERNMENT DRAWINGS, SPECIFICATIONS, OR OTHER DATA ARE USED FOR ANY PURPOSE OTHER THAN IN CONNECTION WITH A DEFINITELY RELATED GOVERNMENT PROCUREMENT OPERATION, THE UNITED STATES GOVERNMENT THEREBY INCURS NO RESPONSIBILITY FOR ANY OBLIGATION WHATSOEVER; AND THE FACT THAT THE GOVERNMENT MAY HAVE FORMULATED, FURNISHED, OR IN ANY WAY SUPPLIED THE SAID DRAWINGS, SPECIFICATIONS OR OTHER DATA IS NOT TO BE REGARDED BY IMPLICATION OR OTHERWISE AS IN ANY MANNER LICENSING THE HOLDER OR ANY OTHER PERSON OR CORPORATION, OR CONVERTING ANY RIGHTS OR PERMISSION TO MANUFACTURE, USE, OR SELL ANY PATENTED INVENTION THAT MAY IN ANY WAY BE RELATED THERETO.

"THIS DOCUMENT HAS BEEN PURCHASED BY THE GOVERNMENT AND MAY BE REPRODUCED AND USED IN CONNECTION WITH ANY GOVERNMENT PROCUREMENT OR MAINTENANCE OPERATION."

SEE NOTE 1

NOTE:  
DATA MARKED BY AN ASTERISK (\*) ARE FOR INFORMATION ONLY, CONTRACTOR MAY, AT HIS OPTION, DEVIATE FROM THESE DETAILS

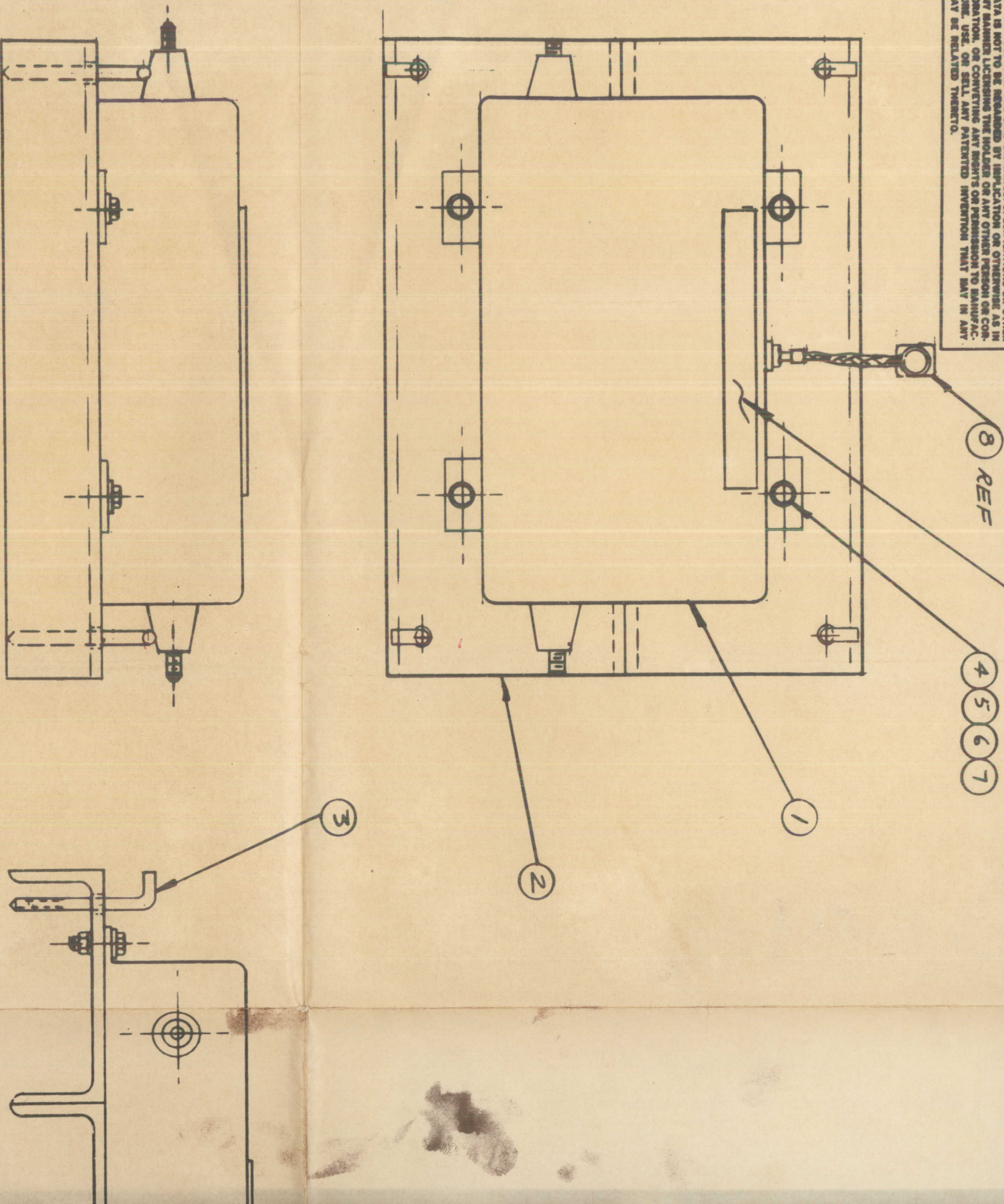

NOTE:  
 DATA MARKED BY AN ASTERISK (\*) ARE FOR  
 INFORMATION ONLY, CONTRACTOR MAY, AT  
 HIS OPTION, DEVIATE FROM THESE DETAILS

\* ECN 1532

REVISIONS			
SYM	DESCRIPTION	DATE	APPROVAL
C	DRAWING REDRAWN WITH MULTIPLE CHANGES	27 FEB 61	4140-M-61 REWA (EC-2) (63)

- NOTES:
1. STENCIL "SLOPING VEE TERMINATOR,  
RECEIVING ANTENNA" IN AREA  
DESIGNATED. GOTHIC 1/8 HIGH, USING  
LUSTERLESS WHITE INK PER  
MIL-1-6557 COLOR NO. 37875 PER  
FED-STD-595 AND COVER  
CHARACTERS WITH CLEAR VARNISH  
PER MIL-V-173, TYPE II
  2. MARKING SHALL MEET THE REQUIRE-  
MENTS OF MIL-M-13231
  3. SUPPLIED BY TECHNICAL MATL CORP,  
MAMARONECK, NY, NO. RTB-5 OR EQUAL

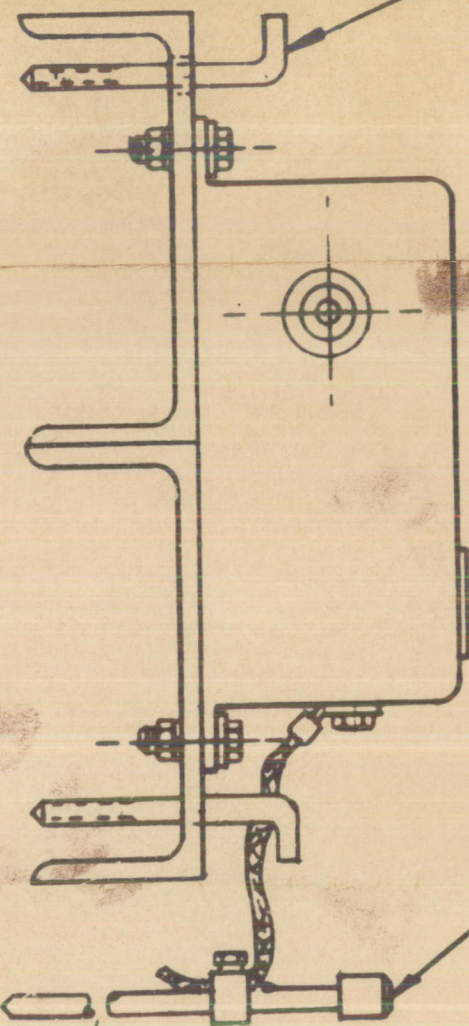

QTY	ITEM	DESCRIPTION	DATE	APPROVAL
8	1	SM-B-396658-GR II		
7	4	MS35690-6/10		
6	4	MS35338-84		
5	4	MS15795-314		
4	4	MS35307-62		
		GROUND ROD ASSY		
		NUT		
		WASHER		
		WASHER		
		SCREW		