

★

TECHNICAL MANUAL

for

MULTI-MODE EXCITER

MODEL MMX ()-2



THE TECHNICAL MATERIEL CORPORATION
MAMARONECK, N. Y. OTTAWA, CANADA

★

★

TECHNICAL MANUAL

for

MULTI-MODE EXCITER

MODEL MMX ()-2



THE TECHNICAL MATERIEL CORPORATION
MAMARONECK, N. Y. OTTAWA, CANADA

COPYRIGHT 1969
THE TECHNICAL MATERIEL CORPORATION

NOTICE

THE CONTENTS AND INFORMATION CONTAINED IN THIS INSTRUCTION MANUAL IS PROPRIETARY TO THE TECHNICAL MATERIEL CORPORATION TO BE USED AS A GUIDE TO THE OPERATION AND MAINTENANCE OF THE EQUIPMENT FOR WHICH THE MANUAL IS ISSUED AND MAY NOT BE DUPLICATED EITHER IN WHOLE OR IN PART BY ANY MEANS WHATSOEVER WITHOUT THE WRITTEN CONSENT OF THE TECHNICAL MATERIEL CORPORATION.



THE TECHNICAL MATERIEL CORPORATION

C O M M U N I C A T I O N S E N G I N E E R S

700 FENIMORE ROAD

MAMARONECK, N. Y.

W a r r a n t y

The Technical Materiel Corporation, hereinafter referred to as TMC, warrants the equipment (except electron tubes,*fuses, lamps, batteries and articles made of glass or other fragile or other expendable materials) purchased hereunder to be free from defect in materials and workmanship under normal use and service, when used for the purposes for which the same is designed, for a period of one year from the date of delivery F.O.B. factory. TMC further warrants that the equipment will perform in a manner equal to or better than published technical specifications as amended by any additions or corrections thereto accompanying the formal equipment offer.

TMC will replace or repair any such defective items, F.O.B. factory, which may fail within the stated warranty period, PROVIDED:

1. That any claim of defect under this warranty is made within sixty (60) days after discovery thereof and that inspection by TMC, if required, indicates the validity of such claim to TMC's satisfaction.
2. That the defect is not the result of damage incurred in shipment from or to the factory.
3. That the equipment has not been altered in any way either as to design or use whether by replacement parts not supplied or approved by TMC, or otherwise.
4. That any equipment or accessories furnished but not manufactured by TMC, or not of TMC design shall be subject only to such adjustments as TMC may obtain from the supplier thereof.

Electron tubes*furnished by TMC, but manufactured by others, bear only the warranty given by such other manufacturers. Electron tube warranty claims should be made directly to the manufacturer of such tubes.

TMC's obligation under this warranty is limited to the repair or replacement of defective parts with the exceptions noted above.

At TMC's option any defective part or equipment which fails within the warranty period shall be returned to TMC's factory for inspection, properly packed with shipping charges prepaid. No parts or equipment shall be returned to TMC, unless a return authorization is issued by TMC.

No warranties, express or implied, other than those specifically set forth herein shall be applicable to any equipment manufactured or furnished by TMC and the foregoing warranty shall constitute the Buyers sole right and remedy. In no event does TMC assume any liability for consequential damages, or for loss, damage or expense directly or indirectly arising from the use of TMC Products, or any inability to use them either separately or in combination with other equipment or materials or from any other cause.

*Electron tubes also include semi-conductor devices.

PROCEDURE FOR RETURN OF MATERIAL OR EQUIPMENT

Should it be necessary to return equipment or material for repair or replacement, whether within warranty or otherwise, a return authorization must be obtained from TMC prior to shipment. The request for return authorization should include the following information:

1. Model Number of Equipment.
2. Serial Number of Equipment.
3. TMC Part Number.
4. Nature of defect or cause of failure.
5. The contract or purchase order under which equipment was delivered.

PROCEDURE FOR ORDERING REPLACEMENT PARTS

When ordering replacement parts, the following information must be included in the order as applicable:

1. Quantity Required.
2. TMC Part Number.
3. Equipment in which used by TMC or Military Model Number.
4. Brief Description of the Item.
5. The *Crystal Frequency* if the order includes crystals.

PROCEDURE IN THE EVENT OF DAMAGE INCURRED IN SHIPMENT

TMC's Warranty specifically excludes damage incurred in shipment to or from the factory. In the event equipment is received in damaged condition, the carrier should be notified immediately. Claims for such damage should be filed with the carrier involved and not with TMC.

All correspondence pertaining to Warranty Claims, return, repair, or replacement and all material or equipment returned for repair or replacement, within Warranty or otherwise, should be addressed as follows:

THE TECHNICAL MATERIEL CORPORATION
Engineering Services Department
700 Fenimore Road
Mamaroneck, New York

CHANGE NO. 1



INSTRUCTION BOOK CHANGE NOTICE

Date September 30, 1969

Manual affected: MMX()-2 IN 2044

- I. Make the following pen and ink corrections on Page 5-1, paragraphs a(2)(d), a(2)(e) and a(2)(f).

Change +1% to +10%.

- II. On Page 5-13, delete the second sentence of sub-paragraph q, beginning with Output filter ---- and make a notation on the page to refer to the alignment procedure contained in this Change.

q. OUTPUT FILTER Z114, ALIGNMENT

TEST EQUIPMENT

Hewlett Packard 606A or Equivalent
Millivac MV28B or Equivalent
Millivac 50 ohm Terminator

- (1) Remove Output Card (Z115) and Filter Card (Z114). Plug Filter Card into Extender Card and reinsert into Z114, leaving Z115 out of chassis during this alignment.
- (2) Place the 10 MHz and 1 MHz selector switches to 25 MHz position.
- (3) Connect HP606A HF signal generator to Terminal E of J114 and the 50 ohm termination for the Millivac MV28B, to connector J124 on the rear panel of the MMX.
- (4) Set signal generator output to 1.0 volt level and adjust Millivac to 1 volt range. Connect Millivac to its 50 ohm termination.
- (5) Set signal generator to 31mc and tune C60 for lowest dip indication on Millivac meter.
- (6) Set signal generator to 54mc and tune C61 for lowest dip indication on Millivac meter.
- (7) Repeat steps (5) and (6) twice.
- (8) Rotate selector switch to 15 MHz position.

SHOULD ADDITIONAL COPIES OF THIS CHANGE NOTICE BE REQUIRED, PLEASE CONTACT:

THE TECHNICAL MATERIEL CORP., 700 Fenimore Road, Mamaroneck, New York

Attn.: Director of Eng. Services.

CHANGE NO. 1 (Cont'd)



INSTRUCTION BOOK CHANGE NOTICE

Date September 30, 1969

Manual affected: MMX()-2 IN 2044

- (9) Leaving 50 ohm termination on the output connector, connect millivac meter (using probe tip) to junction of C49 and C50.
- (10) Set signal generator to 44.5mc and tune C54 for lowest dip on Millivac meter.
- (11) Connect Millivac meter to its 50 ohm termination and set signal generator to 24.5mc. Tune C51 for lowest dip on Millivac meter.
- (12) Set signal generator to 28mc and tune C48 for lowest dip on Millivac meter.
- (13) Repeat Steps (9) thru (12) twice.
- (14) Repeat Steps (8) thru (13) using:
 - (a) 10 MHz position for Step (8).
 - (b) C38 and C39 for Step (9).
 - (c) 25.5mc and C43 for Step (10).
 - (d) 14.5mc and C40 for Step (11).
 - (e) 16mc and C37 for Step (12).
- (15) Repeat Steps (8) thru (13) using:
 - (a) 5 MHz position for Step (8).
 - (b) C27 and C28 for Step (9).
 - (c) 14mc and C32 for Step (10).
 - (d) 8mc and C29 for Step (11).
 - (e) 9mc and C26 for Step (12).
- (16) Rotate selector switch to 3.0 MHz position. Set generator to 1.5mc. Note db level on Millivac.
- (17) Set generator to 3.0mc. Level should drop a minimum of 25db.
- (18) Set generator to 5.0mc. Level should have dropped a minimum of 30db.

SHOULD ADDITIONAL COPIES OF THIS CHANGE NOTICE BE REQUIRED, PLEASE CONTACT:

THE TECHNICAL MATERIEL CORP., 700 Fimmore Road, Mamar neck, New York

Attn.: Director of Eng. Services.

CHANGE NO. 1 (Cont'd)



INSTRUCTION BOOK CHANGE NOTICE

Date September 30, 1969

Manual affected: MMX()-2 IN 2044

- (19) Repeat Steps (16) thru (18) using:
- (a) 3 MHz position and 2.5mc for Step (16).
 - (b) 5.0mc and 30db for Step (17).
 - (c) 8.0mc and 18db for Step (18).
- (20) Repeat Steps (16) thru (18) using:
- (a) 5 MHz position and 4mc for Step (16).
 - (b) 8mc and 25db for Step (17).
 - (c) 14mc and 30db for Step (18).
- (21) Repeat Steps (16) thru (18) using:
- (a) 10 MHz position and 7mc for Step (16).
 - (b) 14mc and 25db for Step (17).
 - (c) 24mc and 30db for Step (18).
- (22) Repeat Steps (16) thru (18) using:
- (a) 15 MHz position and 12mc for Step (16).
 - (b) 24mc and 25db for Step (17).
 - (c) 40mc and 25db for Step (18).
- (23) Repeat Steps (16) thru (18) using:
- (a) 25 MHz position and 20 mc for Step (16).
 - (b) 40mc and 1db for Step (17).
 - (c) 65mc and 8db for Step (18).

SHOULD ADDITIONAL COPIES OF THIS CHANGE NOTICE BE REQUIRED, PLEASE CONTACT:

THE TECHNICAL MATERIEL CORP., 700 Fenimore Road, Mamar neck, New Y rk

Attn.: Director of Eng. Services.



INSTRUCTION BOOK CHANGE NOTICE

Date September 30, 1969

Manual affected: MMX()-2 IN 2044

III. Modify Table 2-1 (Page 2-2) to incorporate the following change, as indicated:

TABLE 2-1. REAR PANEL CONNECTIONS

Panel Designation	Function
J122 (EXT STD)	Input for external frequency standard.
J123 (ALDC)	Input from an associated linear amplifier to improve linearity, limit distortion and deliver a relatively constant output level during high modulation peaks or load changes.
J124 (RF OUT)	RF output jack.
J125 (RF MON)	RF output monitor jack.
TB103 (USB) -1, -2, -3	USB 600-ohm balanced input
-4	Ground terminal
-5, -6	TRANS terminals for connecting PTT relay contacts to external equipment

TABLE 2-1. REAR PANEL CONNECTIONS (Cont)

Panel Designation	Function
TB104 (LSB) -7, -8, -9	LSB 600-ohm balanced input
-10	Ground terminal
-11	Keyer input terminal for CW keying
-12	Ground terminal for CW keying
TB105 -13, -14	Provides a ground for PTT relay through external equipment
-15, -16	FSK inputs for FSK transmission (TTY) battery loop
-17, -18	FAX input
-19, -20	Dry contact input for FSK mode of operation

SHOULD ADDITIONAL COPIES OF THIS CHANGE NOTICE BE REQUIRED, PLEASE CONTACT:

THE TECHNICAL MATERIEL CORP., 700 Fimmore Road, Mamar neck, New York

Attn.: Director of Eng. Services.

CHANGE NO. 2



INSTRUCTION BOOK CHANGE NOTICE

Date December 10, 1969

Manual affected: MMX()-2 IN 2044

- I. On Page 5-6 make the following pen and ink correction:
 - A. Table 5-3 under Attenuator, change Telonic Model from D-550 to D-950.

- II. Replace Pages 6-1 through 6-6 with revised pages supplied with this change. (included in this manual)

- III. On Page 6-25 change the description of CR1, CR2, CR3 and CR4 to read the same as CR1, CR2, CR3 and CR4 on Page 6-5.

- IV. On Page 6-38 change the description of CR1, CR2, CR3 and CR4 to read the same as CR1, CR2, CR3 and CR4 on Page 6-5.

- V. On Page 6-80 change CR1 and CR2 to read same as CR1 and CR2 on Page 6-5, and delete CR-2 on Page 81.

SHOULD ADDITIONAL COPIES OF THIS CHANGE NOTICE BE REQUIRED, PLEASE CONTACT:

THE TECHNICAL MATERIEL CORP., 700 Fimmore Road, Mamar neck, New York

Attn.: Director of Eng. Services.

TABLE OF CONTENTS

Section		Page
1	GENERAL INFORMATION	1-1
	1-1. Functional Description	1-1
	1-2. Physical Description	1-1
	1-3. Technical Specifications	1-1
2	INSTALLATION	2-1
	2-1 General	2-1
	2-2. Power Requirements	2-1
	2-3. Mechanical Installation	2-1
	2-4. Electrical Installation	2-1
	2-5. Initial Checkout Procedure	2-4
3	OPERATOR'S SECTION	3-1
	3-1. General	3-1
	3-2. Controls and Indicators	3-1
	3-3. Operating Procedures	3-4
4	PRINCIPLES OF OPERATION	4-1
	4-1. Introduction	4-1
	4-2. Functional Block Diagram Description	4-1
	a. Spectrum Generator Z101	4-1
	b. Comb Filters Z102 and Z103	4-1
	c. Frequency Select Switching Networks Mixer-Dividers Z104, Z105 and Z106	4-1
	d. Step Generators Z110, Z111 and Z113	4-1
	e. Carrier Generator Z109	4-2
	f. Sideband Generator Z107	4-2
	g. Frequency Shift Generator Z108	4-2
	h. Translator Z112	4-7
	i. RF Output Z115 and Output Filter Z114	4-7
	j. Power Supply Assembly	4-7
	4-3. Detailed Circuit Analysis	4-7
	a. Spectrum Generator Z101	4-7
	b. Comb Filters A (Z102) and B (Z103)	4-8
	c. Frequency Select Switching	4-8
	d. Mixer-Dividers Z104 and Z105, and Final Mixer Z106	4-9
	e. Step Generators Z110, Z111 and Z113	4-9
	f. Carrier Generator Z109	4-10
	g. Sideband Generator Z107	4-11
	h. Mode Switching	4-12
	i. Frequency Shift Generator Z108	4-14
	j. Translator Z112	4-16
	k. RF Output Z115 and Metering Circuit	4-17
	l. Output Filter Z114	4-17
	m. Power Supply Assembly	4-17
5	MAINTENANCE	5-1
	5-1. Preventive Maintenance	5-1
	a. Inspection and Test	5-1
	b. Cleaning Instructions	5-2

TABLE OF CONTENTS (Cont)

Section		Page
5	MAINTENANCE (continued)	
	5-2. Troubleshooting	5-2
	5-3. Alignment	5-6
	a. General	5-6
	b. Test Equipment Required	5-6
	c. Power Supply Boards Z303 and Z304	5-6
	d. Spectrum Generator Z101	5-6
	e. Comb Filter Z102	5-7
	f. Comb Filter Z103	5-7
	g. Single Mixer-Divider Z104	5-7
	h. Dual Mixer-Divider Z105	5-8
	i. Final Mixer Z106	5-8
	j. Carrier Generator Z109	5-9
	k. Sideband Generator Z107	5-9
	l. Frequency Shift Generator Z108	5-10
	m. Step Generator Z110	5-10
	n. Step Generators Z111 and Z113	5-11
	o. Translator Z112	5-12
	p. RF Output Z115	5-13
	q. Output Filter Z114	5-13
	r. Overall Alignment	5-13
	5-4. Repair of Printed Circuitry	5-15
	a. Introduction	5-15
	b. Replacement of Parts	5-15
	c. Checking Printed Circuit Conductors	5-15
	d. Repair of Printed Conductors	5-15
6	PARTS LIST	6-1
7	DRAWINGS	7-1

LIST OF ILLUSTRATIONS

Figure	Title	Page
1-1	Multi-Mode Exciter, Model MMX()-2	1-0
2-1	Tilt-Lock Slide Mechanism	2-1
2-2	Rear Panel Connectors	2-2
2-3	Front Panel Monitor Indicators	2-8
3-1	Controls and Indicators	3-3
4-1	MMX()-2, Functional Block Diagram	4-3
4-2	Frequency Selector Switch Readouts	4-9
4-3	Audio Mode Switching, Simplified Schematic Diagram	4-12
4-4	CW, FSK and FAX Switching, Simplified Schematic Diagram	4-13
4-5	Frequency Shift Keyer Circuit, Simplified Schematic Diagram	4-15
5-1	Top View, Location of Major Components	5-4
5-2	Bottom View, Location of Major Components	5-5
5-3	Power Supply Board, Test Setup	5-6
5-4	Carrier Generator Alignment Waveform	5-9
5-5	Sideband Generator Alignment Waveform	5-9
5-6	Frequency Shift Generator Adjustment Locations	5-10
5-7	Step Generator Z110, Test Setup	5-11
5-8	Translator Z112, Test Setup	5-12
5-9	Carrier Generator Alignment Waveform	5-14
5-10	Carrier Double-Sideband Modulation Waveform	5-14
5-11	Spectrum Generator Z101, Board Component Locations	5-16
5-12	Comb Filter Z102, Board Component Locations	5-16
5-13	Comb Filter Z103, Board Component Locations	5-17
5-14	Single Mixer-Divider Z104, Board Component Locations	5-17
5-15	Dual Mixer-Divider Z105, Board Component Locations	5-18
5-16	Final Mixer Z106, Board Component Locations	5-18
5-17	Side Band Generator Z107, Board Component Locations	5-19
5-18	Frequency Shift Generator Z108, Board Component Locations	5-19
5-19	Carrier Generator Z109, Board Component Locations	5-20
5-20	Step Generator Z110, Board Component Locations	5-20
5-21	Step Generator Z111, Board Component Locations	5-21
5-22	Translator Z112, Board Component Locations	5-21
5-23	Step Generator Z113, Board Component Locations	5-22
5-24	Output Filter Z114, Board Component Locations	5-22
5-25	RF Output Z115, Board Component Locations	5-23
5-26	Power Supply Z303, Board Component Locations	5-24
5-27	Power Supply Z304, Board Component Locations	5-24

LIST OF TABLES

Table	Title	Page
1-1	Technical Specifications	1-1
2-1	Rear Panel Connections	2-1
3-1	Functions of Controls and Indicators	3-1
4-1	Output Filter Pass Bands and Control Relays	4-17
5-1	Weekly Inspection Routine	5-1
5-2	Troubleshooting Chart	5-2
5-3	Test Equipment Required	5-6
5-4	FAX Voltage vs Frequency Linearity Check	5-10
5-5	Exciter Carrier Frequency Output Check	5-15



Figure 1-1. Multi-Mode Exciter, Model MMX()-2

SECTION 1
GENERAL INFORMATION

1-1. FUNCTIONAL DESCRIPTION

This manual presents operating and maintenance instructions for Multi-Mode Exciter, Model MMX()-2, designed and manufactured by The Technical Materiel Corporation, Mamaroneck, New York. The manual includes a general description of the equipment; installation and operating procedures; principles of operation; maintenance data; and a parts list.

Multi-Mode Exciter, Model MMX()-2 (figure 1-1), hereinafter referred to as the MMX()-2, or the Exciter, is a solid-state Exciter used to control the rf output frequency of a transmitter in an SSB (single sideband) transmitting system, providing amplitude-modulated (AM) single sideband (SSB, including amplitude-modulated equivalent (AME) full carrier), or optional independent sideband (ISB) intelligence on an rf carrier frequency between 1.6 and 29.9999 Mhz. The carrier frequency is selectable in discrete 100 Hz increments by means of six frequency selector switches. The Exciter also features built-in frequency stability of 1 part in 10^8 /day, and provides a continuously adjustable 250 mv output in AM, SSB, AME, and optional ISB modes of operation. In addition, the Exciter provides an output of up to one watt for continuous wave (CW), frequency shift keyer (FSK) and facsimile (FAX) operation.

Front panel controls permit operator selection of the operating mode (AM, USB, LSB, ISB (when provided), CW, FSK or FAX). A variable CARRIER control is included in the front panel of the Exciter to permit the operator to establish the desired amount of carrier insertion. Additional front panel controls are provided to adjust the level of the USB or LSB mike/line input, the rf output level, and for monitoring critical circuits. Two front panel jacks permit a 55 dbm low-impedance microphone and a dry-contact keyer to be coupled to the Exciter. A front panel ammeter, used in conjunction with the meter select switch, enables the operator to select and monitor one of seven circuits; Q1, Q2, Q3, LSB, USB, CARR, or RF. Selection of Exciter or press to talk (PTT) operation is accomplished by a front panel selector switch.

Standard BNC connectors are provided on the rear panel of the Exciter to interface the standard 1 MHz output frequency, 1 MHz monitor, Automatic Load and Drive Control (ALDC) circuit, rf output and rf monitor with the external equipment. The remaining interface connections with the external equipment are made at three rear panel mounted terminal boards. These connections are detailed in Section 2, Installation.

NOTE

The terms MHz, kHz and Hz, as used herein, represent megacycles (Mc), kilocycles (Kc) and cycles (cps), respectively.

1-2. PHYSICAL DESCRIPTION

The majority of electronic components which constitute the Exciter are mounted on 17 printed circuit boards which plug into chassis-mounted Cinch connectors. In addition, a standard extender board and power supply extender board are included, and mate with the respective printed circuit boards and chassis connectors, thereby facilitating maintenance, alignment and troubleshooting procedures. The chassis is designed for installation in a standard 19-inch wide electrical equipment cabinet; removable top and bottom protective covers are provided on the chassis.

1-3. TECHNICAL SPECIFICATIONS

Table 1-1 presents a listing of the pertinent electrical and mechanical specifications for the Exciter.

TABLE 1-1. EXCITER SPECIFICATIONS

FREQUENCY RANGE:	1.6 to 29.9999 MHz in 100 Hz incremental steps. For remote tuning, see OPTIONS/ACCESSORIES.
FREQUENCY PRESENTATION:	Direct reading.
MODES OF OPERATION:	CW, AM, SSB, (including AME full carrier), FSK, FAX and ISB (optional extra).
OUTPUT POWER:	Continuously adjustable from 0 to 1 watt for CW, FSK, FAX. Continuously adjustable from 0 to 250 mw PEP for SSB, ISB, AM and AME.
OUTPUT IMPEDANCE:	50 ohms nominal.
FREQUENCY STABILITY:	1 part in 10^8 per day for ambient change of 15° C within the range of 0 - 50° C. 1 part in 10^9 per day (optional with external standard).

TABLE 1-1. EXCITER SPECIFICATIONS (Cont)

FREQUENCY CONTROL:	All frequency determining elements referenced to a built-in 1 MHz source.
METERING:	Built-in multimeter allows monitoring of critical circuits and RF output.
TUNING:	Digital frequency selection by front panel controls.
SIGNAL/DISTORTION RATIO:	Distortion products are at least 40 db below either tone of a two-tone test at 250 mw, which exceeds FCC requirement.
UNWANTED SIDE-BAND REJECTION:	A signal of 500 Hz is at least 60 db down from PEP in the unwanted sideband.
SPURIOUS SIGNALS:	Spurious signals greater than 120 Hz removed from the carrier are at least 60 db below full PEP output.
HUM AND NOISE LEVEL:	Noise level is at least 60 db down from either tone of a two-tone test.
CARRIER INSERTION:	-55 db to full output, continuously variable. <ol style="list-style-type: none"> 1. Flat within ± 1.5 db, 350-3500 Hz, either upper or lower sideband. 2. A filter providing ± 1.5 db, 250-3040 Hz is available on special order. 3. A filter providing ± 1.5 db, 250-6080 Hz is available on special order.
AUDIO INPUT:	<ol style="list-style-type: none"> 1. For ISB, 2 independent 600-ohm channels balanced or unbalanced, -20 dbm to +5 dbm. 2. Built-in microphone pre-amplifier for low level dynamic mike with front panel selection.
MIKE INPUT:	-55 db into 47,000 ohms, front panel jack.

TABLE 1-1. EXCITER SPECIFICATIONS (Cont)

AUDIO CONTROL:	Two front panel "fader" controls allow ease in selecting microphone or line input into either the upper or the lower sideband.
ALDC:	Will accept 0 to approximately -11 vdc from ALDC circuit of an associated linear amplifier to improve linearity, limit distortion and deliver a relatively constant output level during high modulation peaks or load changes.
ENVIRONMENTAL CONDITIONS:	Designed to operate in any ambient temperature between 0° and +50° C, and in any value of humidity up to 95%.
CW KEYING INFORMATION:	Key jack on front panel and connection on rear panel for up to 300 wpm dry contact carrier keying in CW mode.
FSK CAPABILITY:	
KEYING INPUT:	60 ma, 20 ma, 50 volt, 100 volt or CONT either positive or negative with respect to ground.
KEYING SPEED:	Up to 75 baud (higher keying speeds available).
SHIFT:	± 53 Hz, ± 106 Hz, ± 212 Hz, or ± 425 Hz.
FACSIMILE INPUT:	+1 to +10 volts will provide a linear shift of 800 Hz.
INSTALLATION DATA:	Size: 5-1/4" H x 19" W x 18" D. Weight: Approximately 35 lbs.
PRIMARY POWER:	115/230 vac $\pm 10\%$ 50/60 Hz, single-phase, 60 watts.
LOOSE ITEMS:	Mating coaxial fittings (BNC) and instruction manual.
COMPONENTS AND CONSTRUCTION:	All equipment manufactured in accordance with JAN/MIL specifications wherever practicable.

TABLE 1-1. EXCITER SPECIFICATIONS (Cont)

OPTIONS/ACCESSORIES	
1. External Stand- ard CSS-2	Provides 1 part in 10^9 stability.
2. Bandwidth Capability:	6 kHz bandpass filters may be substituted for 3 kHz at additional cost.
3. Remote Oper- ation:	May be equipped for re- mote operation of the digital frequency selec- tor and the mode switches by hardware. Teletype digital format using ex- ternal components is available on a special order.

TABLE 1-1. EXCITER SPECIFICATIONS (Cont)

OPTIONS/ACCESSORIES (continued)	
4. Remote Con- trol Panels:	Control panels for con- venient performance of the above functions are available at extra cost. Please consult TMC on the most economical solution to your remote control requirements.
5. Harmonic Suppression Filter:	Secondary harmonics are attenuated 45 db below full PEP output, and all others at least 55 db below full PEP output, depending upon the Linear Amplifier utilized.

SECTION 2
INSTALLATION

2-1. GENERAL

The Exciter is calibrated and tested at the factory prior to shipment. When the Exciter is received at the operating site, inspect the packing case and contents for possible damage that might have occurred during transit. Unpack the equipment carefully, and inspect all packaging material for parts that have been shipped as loose items. With respect to damage to the equipment for which the carrier is liable, The Technical Materiel Corporation will assist in describing methods of repair and furnishing of replacement parts.

2-2. POWER REQUIREMENTS

CAUTION

When ON/STANDBY switch (9, figure 3-1) is set to STANDBY and the line cord is connected to appropriate power source, the power supply is energized.

The Exciter is designed for 115/230 vac, 50/60 Hz, single phase power operation. Unless specifically ordered otherwise, the unit is shipped wired for 115 vac operation. For 230 vac operation, wiring changes must be made, as shown in figure 7-17. For 230 vac operation, replace line protective fuses having 1/2 the 115 vac fuse rating.

2-3. MECHANICAL INSTALLATION

The Exciter is equipped with a standard 19-inch wide front panel. To install the unit in an equipment rack, fasten the front panel to the rack with four screws and four washers (supplied).

When the Exciter is equipped with a tilt-lock slide mechanism, installation is as follows: (See figure 2-1.)

- a. Pull out center sections of tracks, located in equipment rack, until they lock in extended position.
- b. Position slide mechanisms of unit in tracks, and ease unit into rack until release fingers engage holes in tracks.
- c. Press release fingers and slide unit completely into rack. Secure front panel of unit to rack with screws and washers.
- d. Make necessary electrical connections, as described in paragraph 2-4.

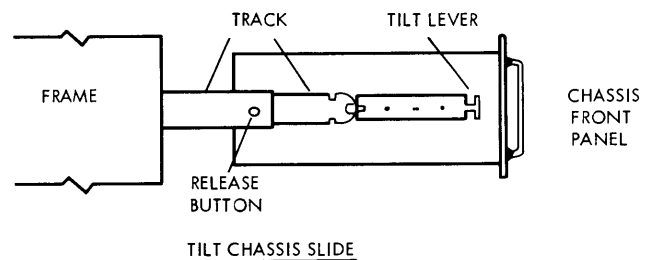
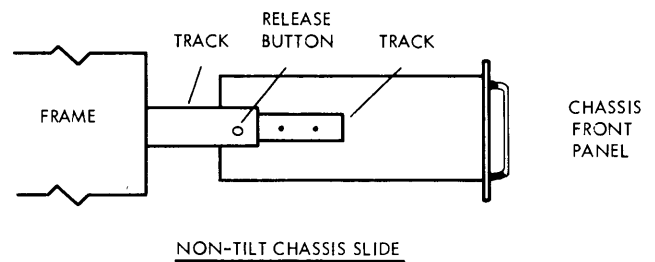

Figure 2-1. Tilt-Lock Slide Mechanism

2-4. ELECTRICAL INSTALLATION

All electrical connections between the Exciter and associated equipment are made at the rear of the unit. Figure 2-2 illustrates all rear panel connections, while table 2-1 lists the panel designation and function of each connection.

TABLE 2-1. REAR PANEL CONNECTIONS

Panel Designation	Function
J116 (POWER)	Power input for 115 vac or 230 vac line power.
J119 (Remote Input)	Optional input connector for remote control operation.
J120 (1 MHz OUT)	1 MHz standard output jack.
J121 (1 MHz MON)	1 MHz standard monitor jack.

TABLE 2-1. REAR PANEL CONNECTIONS (Cont)

Panel Designation	Function
J122 (EXT STD)	Input for external frequency standard.
J123 (ALDC)	Input from an associated linear amplifier to improve linearity, limit distortion and deliver a relatively constant output level during high modulation peaks or load changes.
J124 (RF OUT)	RF output jack.
J125 (RF MON)	RF output monitor jack.
TB103 (USB) -1, -2, -3	USB 600-ohm balanced input
-4	Ground terminal
-5, -6	TRANS terminals for connecting PTT relay contacts to external equipment

TABLE 2-1. REAR PANEL CONNECTIONS (Cont)

Panel Designation	Function
TB104 (LSB) -7, -8, -9	LSB 600-ohm balanced input
-10	Ground terminal
-11	Keyer input terminal for CW keying
-12	Ground terminal for CW keying
TB105 -13, -14	Provides a ground for PTT relay through external equipment
-15, -16	FSK inputs for FSK transmission (TTY) battery loop
-17, -18	FAX input
-19, -20	Dry contact input for FSK mode of operation

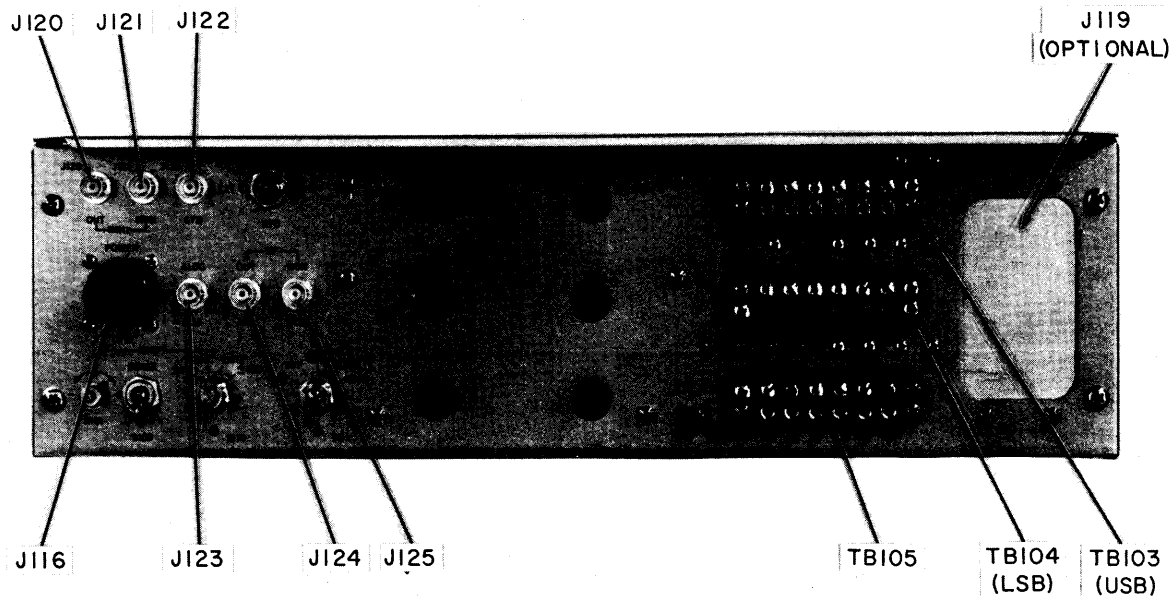

Figure 2-2. Rear Panel Connectors

2-5. INITIAL CHECKOUT PROCEDURE (See figures 2-2 and 2-3.)

Although the Exciter has been aligned and thoroughly checked against the manufacturer's specifications prior to shipment, it is necessary to ensure correct installation and proper Exciter operating conditions by performing the following checkout procedures. Refer to Section 3 for location and functions of all operating controls and indicators.

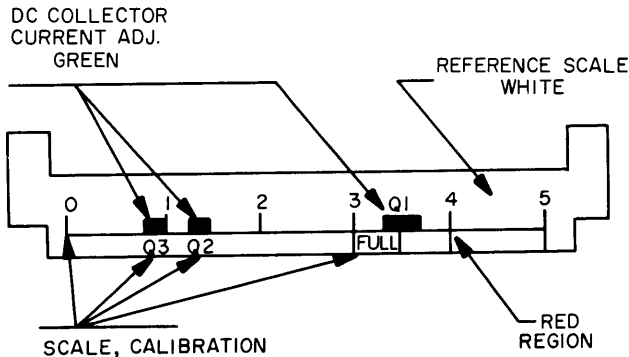

Figure 2-3. Front Panel Monitor Indicator

NOTE

Unless otherwise indicated, item numbers (numbers in parenthesis) are callouts referred to figure 3-1.

- a. Set ON/STANDBY switch (9) to STANDBY position.
- b. Connect source of 115 vac line power to connector J116 (figure 2-2). STANDBY indicator (8) shall illuminate amber.
- c. Position RF OUTPUT control (1) fully counterclockwise.
- d. Using frequency selector switches (14), set output frequency to 29.9999 MHz.
- d. Position CARRIER control (13) fully counterclockwise.

- f. Position MODE switch (12) to ISB.
- g. Position EXCITER Switch (11) to ON
- h. Set MIKE/LINE controls (4) and (6) to 0.
- i. Position METER switch (2) to Q1.
- j. Connect Hewlett-Packard Model 200 CD Audio generator (or equivalent) to USB 600-ohm terminals (TB103) and LSB 600-ohm terminals (TB104), located on rear panel of Exciter. Set audio frequency for 1000 Hz at 10 volts.
- k. Position ON/STANDBY switch (9) to ON. STANDBY indicator (8) shall extinguish and POWER indicator (10) shall illuminate red.
- l. Verify the MONITOR meter (5) is in the green region marked Q1. (See figure 2-3.)
- m. Set METER switch (2) to Q2. MONITOR meter (5) shall indicate in the green region marked Q2. (See figure 2-3.)
- n. Set METER switch (2) to Q3. MONITOR meter (5) shall indicate in the green region marked Q3. (See figure 2-3.)
- o. Set METER switch (2) to RF; MONITOR meter (5) shall indicate zero with RF OUTPUT control (1) fully counterclockwise.
- p. Connect a VTVM (Hewlett-Packard Model 410B, or equivalent) to RF OUT jack J124 (figure 2-2) across a 47-ohm load resistor.
- q. Adjust RF OUTPUT control (1) for a minimum indication of 3.5 volts on VTVM.
- r. Set METER switch (2) to USB and adjust USB MIKE/LINE control (6) for an indication of 2/5 full scale on MONITOR meter (5).
- s. Set METER switch (2) to LSB and adjust LSB MIKE/LINE control (4) for an indication of 2/5 full scale on MONITOR meter (5).
- t. Set METER switch (2) to CARR position. MONITOR meter (5) shall indicate zero.
- u. Rotate CARRIER control (13) slowly clockwise; MONITOR meter (5) indication shall increase to FULL when CARRIER control (13) is fully clockwise.
- v. Disconnect all test equipment and remove power from Exciter.

SECTION 3

OPERATOR'S SECTION

3-1. GENERAL

The MMX()-2 provides rapid rf frequency selection of AM, USB, LSB, or ISB intelligence in the 1.6 to 29.9999 MHz transmission range. Tuning over this frequency range is accomplished manually in incremental tuning steps of 100 Hz using six front panel frequency-select switches. In addition, the

Exciter contains provisions for operating in the CW, FSK and FAX modes.

3-2. CONTROLS AND INDICATORS

All operator controls and indicators are located on the front and rear panels of the Exciter. Figure 3-1 illustrates the front and rear panels, and table 3-1 presents a listing of the controls and indicators and explains the function of each.

TABLE 3-1. FUNCTIONS OF CONTROLS AND INDICATORS

Item Number (figure 3-1)	Panel Designation	Function
1	RF OUTPUT control	Adjusts rf output level
2	METER switch (seven-position)	Selects circuit in MMX()-2 to be monitored by MONITOR meter
	Q1	Displays rf output transistor Q1 collector current (350 ma) on MONITOR meter
	Q2	Displays rf output transistor Q2 collector current (130 ma) on MONITOR meter
	Q3	Displays rf output transistor Q3 collector current (65 ma) on MONITOR meter
	LSB	Displays LSB output level on MONITOR meter
	USB	Displays USB output level on MONITOR meter
	CARR	Displays carrier level on MONITOR meter
	RF	Displays RF output level on MONITOR meter
3	SPARES (2) fuses	Spare one-ampere line voltage fuses
4	LSB MIKE/LINE control	Adjusts level of LSB input
5	MONITOR meter	Monitors circuit function selected by METER switch

TABLE 3-1. FUNCTIONS OF CONTROLS AND INDICATORS (Cont)

Item Number (Figure 3-1)	Panel Designation	Function
6	USB MIKE/LINE control	Adjusts level of USB input
7	LINE (2) fuses	One-ampere line voltage fuses
8	STANDBY indicator	Illuminates amber when ON/STANDBY switch is positioned to STANDBY
9	ON/STANDBY switch	When positioned to ON, applies 12 and 24 vdc to modules and illuminates red POWER indicator When positioned to STANDBY, removes dc voltages from modules and illuminates amber STANDBY indicator
10	POWER indicator	Illuminates red when ON/STANDBY switch is positioned to ON
11	EXCITER ON/PTT switch	Set to ON position for all operating modes using inputs other than MIKE. Set to PTT when using MIKE input
12	MODE switch (seven-position)	Establishes one of seven operating modes, depending upon options supplied: AM, USB, LSB, ISB, CW, FSK or FAX
13	CARRIER control	Establishes the amount of carrier used
14	100 Hz, 1 kHz, 10kHz, 100 kHz, 1 MHz and 10 MHz switches	Used to establish the desired operating frequency
15	MIKE jack	Accept a 47,000-ohm impedance microphone input
16	KEY jack	Accepts dry contact keyer input used for CW mode of operation
17	STD-INT/EXT switch	Used to select the internal 1 MHz oscillator frequency, or an external 1 MHz standard input frequency

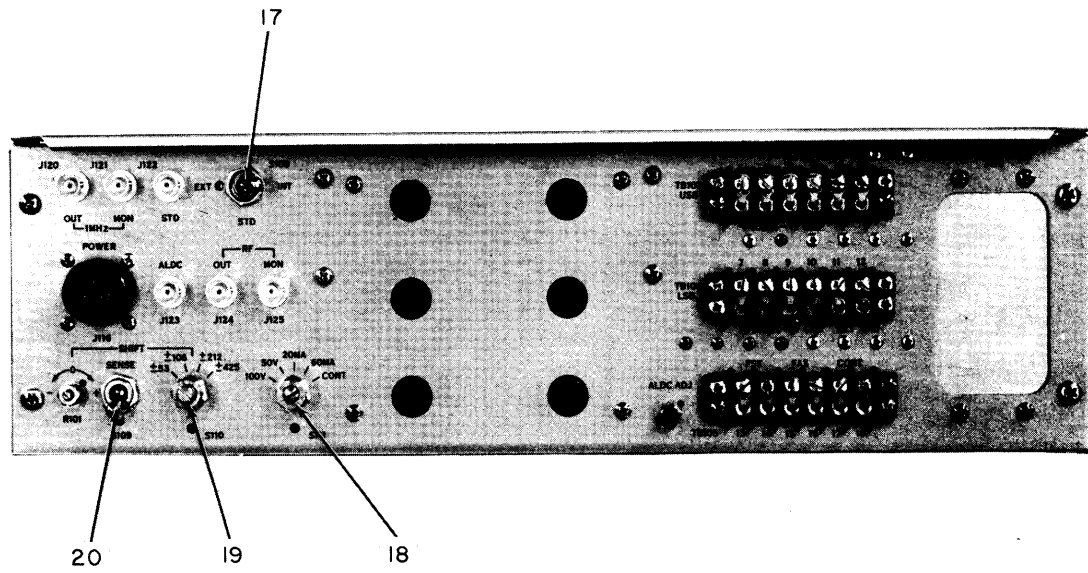
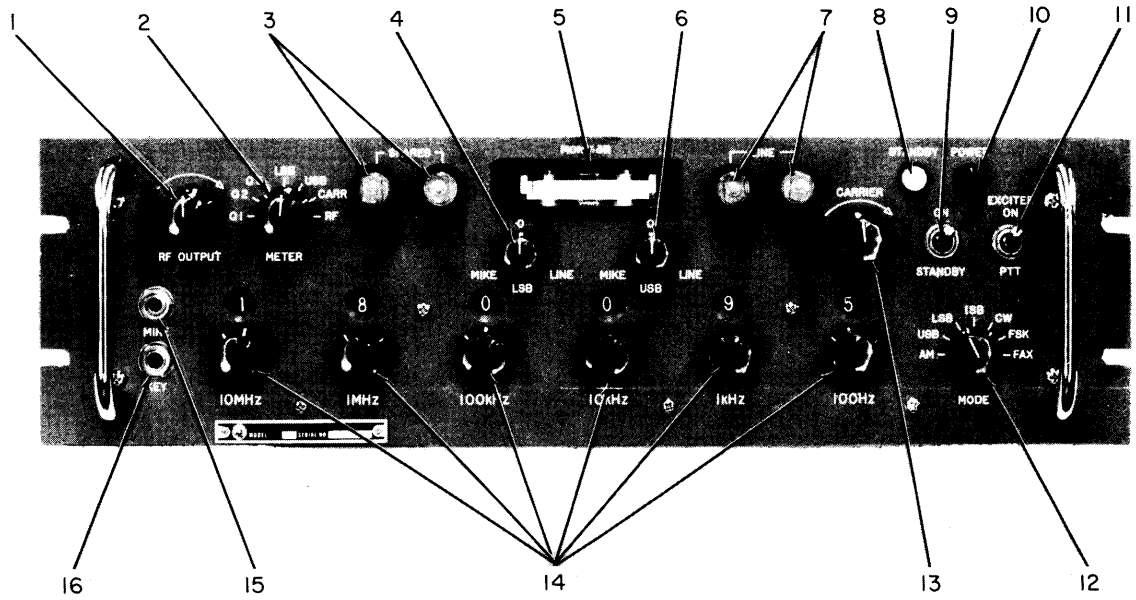

Figure 3-1. Controls and Indicators

TABLE 3-1. FUNCTIONS OF CONTROLS AND INDICATORS (Cont)

Item Number (Figure 3-1)	Panel Designation	Function
18	FSK LOOP input switch	Selects proper FSK loop input; 100V, 10V, 20MA, 60MA or CONT
19	SHIFT switch (four-position)	Determines the "mark" and "space" frequency shift above or below the carrier frequency: ± 53 , ± 106 , ± 212 or ± 425 Hz
20	SENSE switch (two-position)	Establishes sense + (positive) or - (negative) in the FSK mode of operation

3-3. OPERATING PROCEDURES

Before initially placing the Exciter in operation, perform the initial checkout procedure outlined in Section 2, Installation. To place the Exciter in operation:

NOTE

Verify that ON/STANDBY switch (9, figure 3-1) is set to STANDBY.

- a. Connect a source of 115 vac, single-phase power to connector J116 (figure 2-2). Observe that STANDBY indicator (8) illuminates amber.
- b. Make necessary interface connection on rear panel jack (figure 2-2).

3-4. SINGLE SIDEBAND WITH ANY DEGREE OF CARRIER INSERTION (INCLUDING AME FULL CARRIER).

- a. Set ON/STANDBY switch (9) to ON.
- b. Set EXCITER switch (11) to ON position when using either the USB or LSB 600-ohm line (external signal source) inputs. Set EXCITER switch to PTT position when using MIKE input (15).
- c. Select desired sideband with MODE switch (12).
- e. Turn METER switch (2) at the desired sideband.
- f. Connect a Mike to the front panel MIKE jack (15) if used.

- g. Adjust the MIKE/LINE control of sideband used to appropriate level as indicated on MONITOR (5).

NOTE

DO NOT ENTER RED REGION. When mike input is used, adjust level so as not to exceed red region with highest input from microphone.

- h. Turn METER switch (2) to CARR position. Adjust CARRIER control (13) to the desired level as indicated on MONITOR meter (5).
- i. Turn METER switch (2) to RF position. Adjust RF OUTPUT control (1) for desired level of RF output as indicated on MONITOR meter (5).

NOTE

Turn RF OUTPUT control (1) fully CCW before selecting different modes of operation.

3-5. INDEPENDENT SIDEBAND WITH ANY DEGREE OF CARRIER

- a. Set ON/STANDBY switch (9) to ON position.
- b. Set EXCITER switch (11) to ON position when using either the USB or LSB 600-ohm line (external signal source) inputs. Set EXCITER switch (11) to PTT position when using a MIKE input (15).
- c. Set USB (6) and LSB (4) controls to zero.
- d. Select ISB position on MODE switch (12).

e. Turn METER switch (2) to LSB position. Adjust the LSB GAIN control (4) for a MONITOR meter (5) indication of up to but not to exceed the red region.

f. Turn METER switch (2) to USB position. Adjust USB GAIN control (6) for a MONITOR meter (5) indication of up to but not to exceed the red region.

g. Turn METER switch (2) to the CARR position. Adjust CARRIER control (13) to full or the desired level as indicated on MONITOR meter (5).

h. Turn METER switch (2) to the RF position and adjust RF OUTPUT control (1) for the level of RF output indicated on MONITOR meter (5).

3-6. CONVENTIONAL AM OPERATION

a. Set ON/STANDBY switch (9) to ON position.

b. Set EXCITER switch (11) to ON position when using either the USB or LSB 600-ohm line (external signal source) input. Set EXCITER switch (11) to PTT position when using MIKE input (15).

c. Set MODE switch (12) to AM position.

d. Connect a mike to front panel MIKE jack (15) if used.

e. Adjust the MIKE control (4) or (6) of side-band used to appropriate level as indicated on MONITOR meter (5).

f. Turn METER switch (2) to RF. Vary RF OUTPUT control (1) for desired level of RF output as indicated on MONITOR meter (5).

3-7. FREQUENCY SHIFT TELEGRAPH OPERATION

a. Set ON/STANDBY switch (9) to ON position.

b. Set EXCITER switch (11) to ON position.

c. Turn MODE switch (12) to FSK position.

d. Select appropriate FSK operation by setting FS LOOP (18) and SHIFT (19) switches.

e. Place SENSE switch (20) to desired sense (+) or (-).

f. Place METER switch (2) to the RF position. Adjust RF OUTPUT control (1) for desired MONITOR meter (5) reading.

3-8. FACSIMILE (FAX) OPERATION

a. Set ON/STANDBY switch (9) to ON position.

b. Set EXCITER switch (11) to ON position.

c. Turn MODE switch (12) to FAX position.

d. Place METER switch (2) to the RF position. Adjust RF OUTPUT control (1) for desired MONITOR meter (5) reading.

3-9. CW TELEGRAPH OPERATION

a. Set ON/STANDBY switch (9) to ON position.

b. Set MODE switch (12) to CW position.

c. Connect key to KEY input (16).

SECTION 4

PRINCIPLES OF OPERATION

4-1. INTRODUCTION

The principles of operation for the MMX()-2 is presented in two parts. The first part discusses MMX()-2 operation with reference to an overall functional block diagram, while the second part presents a detailed description of the individual MMX()-2 circuits and is referenced to the inter-connection and schematic diagrams contained in Section 7.

4-2. FUNCTIONAL BLOCK DIAGRAM DESCRIPTION (See figure 4-1.)

The MMX()-2 is an rf exciter capable of providing amplitude-modulated (AM) operation; single sideband suppressed carrier (SSSC) or conventional single sideband (SSB) operation; independent sideband (ISB) operation; continuous wave (CW) keyed operation; frequency shift keyer (FSK) operation and facsimile (FAX) operation. The rf output appears in the 1.6 kHz to 29.9999 MHz frequency range, and is selectable in discrete 100 Hz increments by means of six frequency selector switches. The Exciter includes a spectrum generator; two comb filters, a frequency select switching network; a single mixer-divider; a dual mixer-divider; a final mixer; three step generators; a double-sideband generator; a carrier generator and AM amplifier; a frequency shift generator and converter; an rf translator and ALDC circuit; an rf output amplifier; an rf output filter; a mode-switching network, and a power supply assembly. The following paragraphs present brief descriptions of each of these sections.

a. **SPECTRUM GENERATOR Z101.** The spectrum generator develops seven fundamental output frequencies which are derived from a stable 1 MHz standard in the power supply assembly. Firstly, the 1 MHz input is amplified and sent to the mixer-divider circuits for formulation of four discrete decimal integers to enable frequency selection in 100 Hz steps. Secondly, the 1 MHz input is clipped, divided by a factor of 10 and applied to a 100 kHz spectrum generator; this output, containing the 100 kHz fundamental, plus harmonics, is applied to the comb filter circuits. Finally, the 1 MHz input is squared to produce a 1 MHz spectrum containing the required harmonics for generation of five additional output frequencies of 8, 12, 13, 14 and 40 MHz. The 8 MHz output is applied to the mixer-divider sections as the fundamental input frequency; the 40 MHz output is coupled to the frequency translator for determination of final output frequency range; and the 12, 13 and 14 MHz outputs are sent to the step generator circuits for derivation of the basic difference frequency range for use in the translator.

b. **COMB FILTERS Z102 AND Z103.** The 100 kHz spectrum output from the spectrum generator is applied to the comb filter sections. These circuits

produce 12 discrete output frequencies from 0.8 to 1.9 MHz in 100 kHz steps and apply them to the frequency select switch network. These frequencies are generated by exciting corresponding crystal-filters at the appropriate harmonic of the 100 kHz spectrum input. The 1.0 to 1.9 MHz output range is applied to the 100 Hz, 1 kHz, 10kHz, and 100 kHz select switches which control the mixer-divider sections. The complete range of 0.8 to 1.9 MHz is applied to the 1 MHz and 10 MHz select switches which control the input to the step generator circuits.

c. **FREQUENCY SELECT SWITCHING NETWORKS, AND MIXER-DIVIDERS Z104, Z105 AND Z106.** The mixer-divider sections consist of four frequency channels that can be considered as a cascaded frequency counter; each channel is controlled by a frequency select switch to determine the appropriate 100's, 1000's, 10,000's and 100,000's integers of the desired output frequency. The 8 MHz input from the spectrum generator is applied to each of the four channels; in the 100 Hz channel, this signal is modulated by the 1 MHz input to yield a basic frequency of 9 MHz. This frequency is then mixed with the 1.0 to 1.9 MHz input from the 100 Hz selector switch to produce a sum frequency of 10 to 10.9 MHz, which is divided by 10 to yield a 1.0 to 1.09 MHz input to the next mixer-divider channel. By modulating the 8 MHz input to each successive channel with the net input from the previous channel and the desired frequency from the next higher frequency selector switch, a final output of 10.0 to 10.9999 MHz results, with the last four digits representing the least significant four decimal places in the selected output frequency. The 10.0 to 10.9999 MHz output is applied to the frequency translator section.

d. **STEP GENERATORS Z110, Z111 AND Z113.** The step generators perform the function of first shifting the 12, 13 and 14 MHz inputs to three independent but successive frequency ranges under control of the 1 MHz and 10 MHz frequency select switches, thereby deriving the two most significant digits of the desired output frequency. Frequency ranges of 10.4 to 11.2 MHz, 11.3 to 12.2 MHz, and 12.3 to 13.2 MHz are derived in step generators Z113 and Z110 by modulating respective input frequencies of 12, 13 and 14 MHz from the spectrum generator with the 0.8 to 1.7 MHz selected frequency from the 1 and 10 MHz switches and amplifying the difference. These three frequency ranges are then multiplied by 5, filtered and amplified in step generator Z111 to obtain 52 to 56 MHz, 56.5 to 61 MHz, and 61.5 to 66 MHz frequency range inputs to step generator Z113. Finally, each of these three ranges are multiplied by 2, amplified and then summed together to produce an output frequency range of 104 to 132 MHz. This signal is supplied through a low-pass filter to the frequency translator.

e. **CARRIER GENERATOR Z109.** The carrier generator develops a basic subcarrier frequency of 250 kHz, and a 2.75 MHz carrier frequency used for conversion and subsequent translation to an rf output frequency band; it also contains a meter amplifier circuit for upper and lower sideband audio translation to an equivalent level for display on the MONITOR meter, when USB or LSB audio is selected by the METER switch. In addition, an AM amplifier circuit is included, and provides an audio amplitude-modulated 250 kHz output when the AM mode of operation is selected.

The carrier generator receives a 1 MHz standard frequency input from the power supply assembly, which is supplied to both the 250 kHz and 2.75 MHz frequency generation circuits. In the 250 kHz channel, the 1 MHz input is divided by 4 to derive the basic 250 kHz subcarrier frequency; a switched ground enable is applied from the mode switching network in the AM, USB, LSB, ISB and FSK modes to enable a 250 kHz subcarrier output signal; in the CW mode, the ground enable is interrupted at the key rate, thereby producing a 250 kHz CW output. The 250 kHz output is applied to the mode switching network for distribution to the various sections of the Exciter in accordance with the MODE switch setting, and to the CARRIER control network for carrier reinsertion, when desired. In the FAX mode, the 250 kHz channel is disabled.

The 2.75 MHz channel produces an rf output by dividing the 1 MHz input by 4 and then multiplying the resultant by 11 to derive the 2.75 MHz translation frequency. Switched +12 vdc to this channel and to the AM amplifier section is controlled by the MODE switch and is present in the AM, USB, LSB, ISB and CW positions. The 2.75 MHz output is supplied to the converter section of the frequency shift generator for translation to a resultant 3 MHz rf carrier.

The AM amplifier section develops an amplitude-modulated 250 kHz signal in the AM mode of operation, and consists of an audio amplifier and mixer circuit. In the AM mode, USB and/or LSB audio is routed to the audio amplifier stage and then to the mixer; the 250 kHz subcarrier is applied directly to the mixer. The resultant amplitude-modulated 250 kHz signal is then routed through the AM position of the MODE switch to the converter section of frequency shift generator Z108.

f. **SIDEBAND GENERATOR Z107.** The sideband generator includes upper and lower sideband circuits which are similar in configuration and operation; the exception is the tuned frequency of the USB and LSB amplifier circuits. The sideband generator also contains a microphone audio preamplifier, and an audio impedance-matching transformer for translation of externally applied 600-ohm USB/LSB line audio to a 500-ohm audio output.

When a microphone input is used, the front panel EXCITER switch is set to the press-to-talk (PTT) position to furnish a PTT ground enable to the

carrier generator via the mode switching network; in all other modes, the EXCITER switch is set to the ON position, which supplies a permanent ground to the same point, except in the case of CW. Microphone audio from 300 Hz to 7.5 kHz is applied to the sideband generator audio preamplifier circuit, and then to the mode switching network for redistribution to either, or both, of the sideband generator modulator circuits. Similarly, 600-ohm line audio from 350 Hz to 3.5 kHz is translated to a 500-ohm line output and applied to the mode switching network. In the USB, LSB and ISB modes, the audio is routed to the modulation input of the respective, or each, sideband generator; in the AM mode, the respective audio signal is applied to the AM amplifier in carrier generator Z109. USB and LSB audio amplitude is controlled by a respective front panel MIKE/LINE gain control.

The SSB modulation section of the sideband generator accepts both a 250 kHz subcarrier input and the USB/LSB audio signal via the MODE switch. These two signals are applied to a balanced modulator to derive the upper and/or lower sideband intelligence; the 250 kHz subcarrier is suppressed. The resulting USB and/or LSB signals are supplied to the mode switching network and are then routed to the converter section of frequency shift generator Z108.

g. **FREQUENCY SHIFT GENERATOR Z108.** The frequency shift generator consists of two sections; namely the frequency shift generator section and the converter section. The frequency shift generator section operates in the frequency shift keyer (FSK) and facsimile (FAX) modes; it contains a 3 MHz amplifier, a keyer-modulator and dc amplifier section, and the FAX circuit. FSK operation is controlled by the SHIFT and FS LOOP switches. The converter section operates in all other modes except FSK and FAX, and functions to produce an amplitude-modulated (AM) or single sideband (SSB) rf carrier of 3 MHz for use in frequency translator Z112.

In the FSK mode, the 250 kHz subcarrier is applied to the keyer modulator, which also receives an external teletype input via the FS LOOP switch. Therefore, the subcarrier is effectively modulated by a current input representing teletype marks and spaces; the FS LOOP switch network is set to the appropriate voltage rating, and when a dry-contact keyer is used, the switch is set to the contact (CONT) position. The keyer-modulator thus produces a shift in frequency above and below the 250 kHz center frequency. This shift is rectified and translated to a dc level, which is then amplified and applied to the 3 MHz variable crystal-controlled oscillator (VXCO) in the power supply assembly via the SHIFT switch network.

When FSK or FAX operation is selected, +12 vdc is supplied to both the frequency shift generator and to the VXCO in the power supply assembly. As a result, the VXCO operates at the center frequency of 3 MHz. Upon application of the

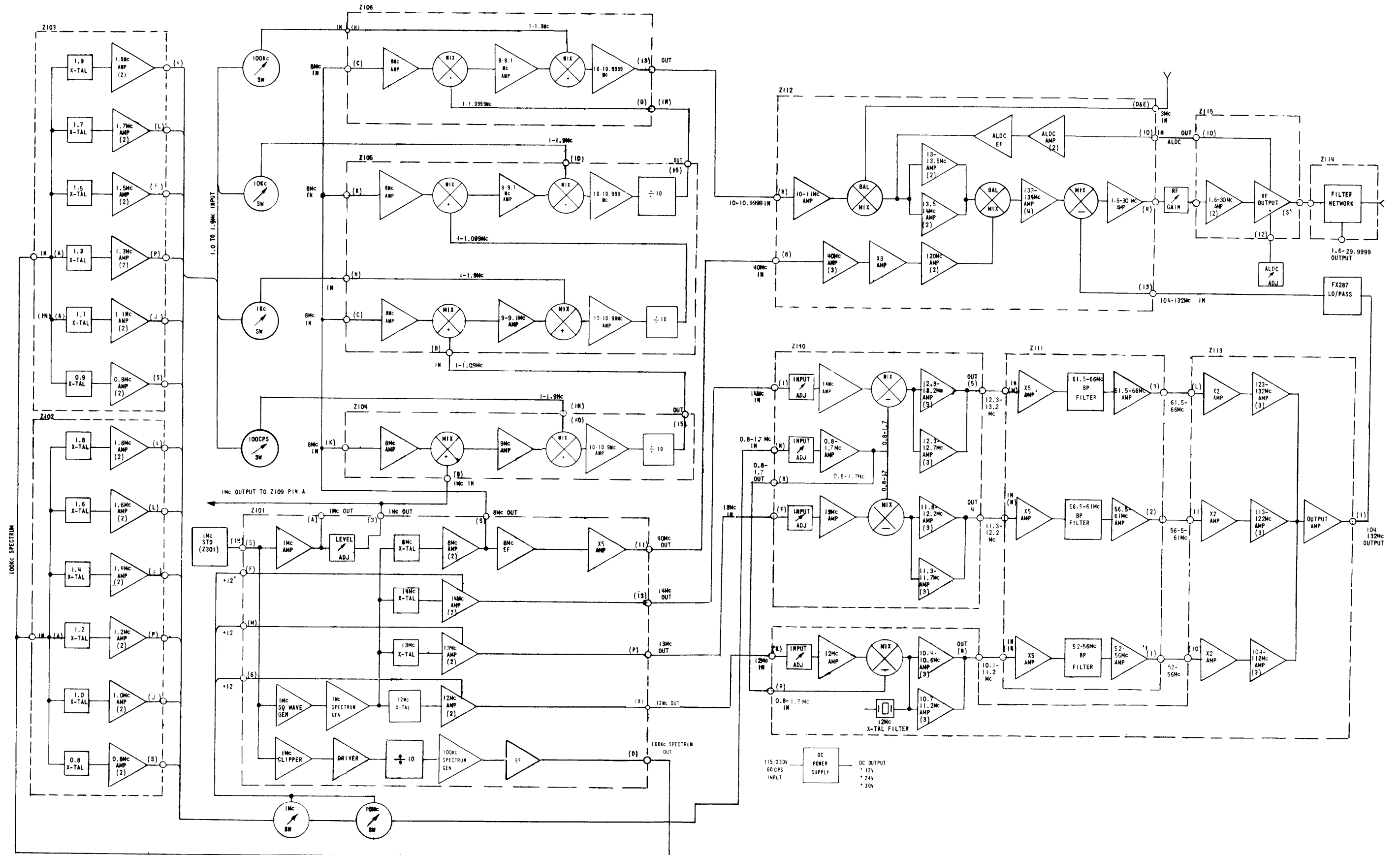

Figure 4-1. MMX()-2, Functional Block Diagram (Sheet 1 of 2)

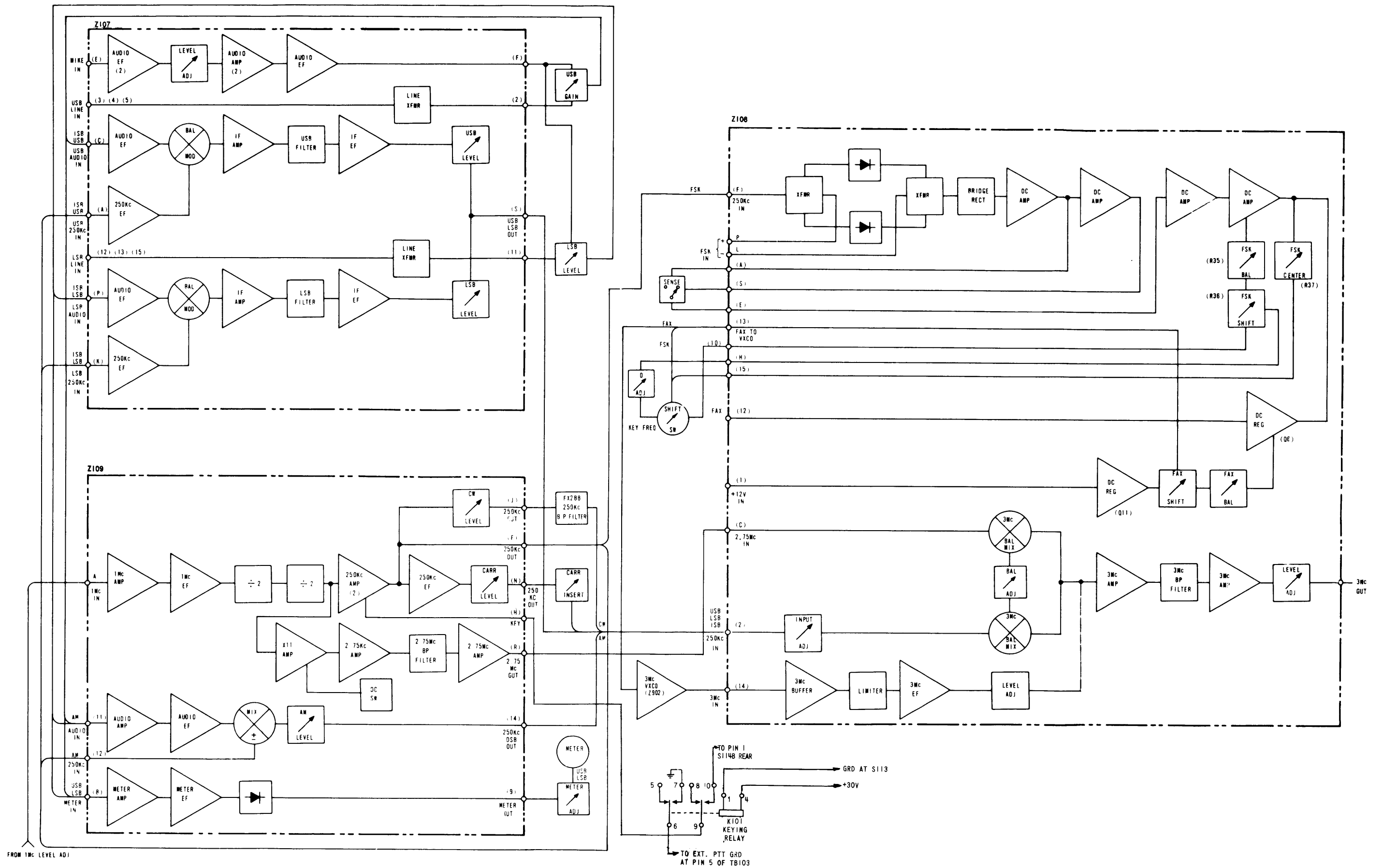

Figure 4-1. MMX()-2, Functional Block Diagram (Sheet 2 of 2)

variable dc level (E MOD) from the SHIFT switch, the frequency of the VXCO is shifted above and below center frequency, corresponding to respective marks and spaces, by an amount determined by SHIFT switch setting (± 53 , ± 106 , ± 212 , ± 425). The frequency-shifted VXCO signal of 3 MHz is re-applied to the 3 MHz VXCO amplifier section of the frequency shift generator and then to the 3 MHz amplifier circuit of the converter section.

In FAX operation, an externally applied FAX signal produces a variable dc level through a dc regulator circuit. This level is applied to the VXCO to produce the required frequency shift.

The converter section of Z108 accepts the 2.75 MHz carrier from carrier generator Z109; the 250 kHz AM, USB, LSB, ISB or CW input from the mode switching network; or the 3 MHz VXCO input from the 3 MHz VXCO amplifier in the frequency shift generator section.

In the AM mode, the 2.75 MHz carrier and the amplitude-modulated 250 kHz signal are mixed in a balanced modulator to produce a sum amplitude-modulated carrier of 3 MHz, which is amplified and applied to translator Z112. In the USB, LSB and ISB modes, the input signals consist of the 2.75 MHz carrier and USB and/or LSB audio with, or without, the 250 kHz signal, depending upon the amount of carrier suppression introduced by the CARRIER control network. This control permits continuously variable carrier reinsertion from zero (0) to full by attenuating the 250 kHz input from the mode switching network. The attenuated 250 kHz subcarrier from the CARRIER control is applied to the mode switching network, where it is reinserted with the USB and/or LSB audio as a pilot carrier prior to being sent to the converter section of Z108. Therefore, the 250 kHz USB, LSB or ISB signal is mixed with the 2.75 MHz carrier to again produce a single sideband or independent sideband output with a 3 MHz center frequency.

In the CW mode, the 250 kHz input is interrupted at the keyer rate and thus results in a 3 MHz CW output. In the FSK and FAX modes, the 250 kHz and 2.75 MHz inputs are not present; the only input is the 3 MHz VXCO signal from the frequency shift generator 3 MHz amplifier section, which is further amplified in the converter section and then applied to translator Z112.

A keying relay is energized whenever the EXCITER switch is set to the ON position. As a result, when the CW mode is selected, the ground from the external key is coupled through the MODE switch and the normally-closed contacts of the relay to both the carrier generator and the translator, thereby initiating CW operation.

h. TRANSLATOR Z112. The translator performs the function of producing a 1.6 to 29.9999 MHz output signal by modulating the 10 to 10.9999 MHz output signal from final mixer Z106 with the 3 MHz from the frequency shift generator; the 40

MHz signal from the spectrum generator; and the 104 to 132 MHz output range from step generator Z113. The 10.0 to 10.9999 MHz input is amplified and modulated by the 3 MHz input to yield a 13 to 13.9999 MHz output; this frequency range is then modulated by the 120 MHz derived from the 40 MHz input multiplied by a factor of 3. As a result, the modulator yields a sum frequency between 133 and 133.9999 MHz. By subtracting the 104 to 132 MHz signal, representing the two most significant digits of the selected frequency range, a difference output signal results in the range of 1.6 to 29.9999 MHz. This output signal is applied through the RF OUTPUT control to rf output section Z115.

When the upper frequency range (20 - 29.9999 MHz) is selected, a ground enable is applied to a filter relay which inserts a high-frequency pre-filter in series with the rf signal from the RF OUTPUT control. Therefore, the rf signal is pre-filtered prior to being applied to rf output section Z115.

i. RF OUTPUT Z115 AND OUTPUT FILTER Z114. The 1.6 to 29.9999 MHz output signal from the translator is amplified in rf output section Z115 and applied to output filter Z114. The filter network consists of six independent relay-controlled bandpass output filters; the appropriate filter is inserted in series with the output signal according to the desired frequency set on the frequency selector switches.

A metering circuit is included to monitor the collector currents of the three amplifiers on rf output section Z115 and the rf output level of the selected frequency; these parameters are selected by a METER switch and displayed on the front panel MONITOR meter.

j. POWER SUPPLY ASSEMBLY. The MMX()-2 power supply operates from either 115 or 230 vac when the power transformer is properly wired. The power supply outputs are regulated dc voltages of +30, +24 and +12 volts for operation of the Exciter circuits. The +24 and +12 vdc power supply outputs are applied to the STANDBY position of the ON/STANDBY switch and are applied to the Exciter when set to the ON position. The 1 MHz and 3 MHz frequency standards are produced by crystal-controlled oscillators; the 1 MHz signal is applied to the spectrum generator, while the 3 MHz signal, enabled in the FSK and FAX modes, is applied to the frequency shift generator.

4-3. DETAILED ANALYSIS

The following paragraphs present a detailed description of the circuits used to provide rf frequency generation, selection and translation in the MMX()-2. The circuit descriptions are referenced to applicable schematic and interconnection diagrams in Section 7.

a. SPECTRUM GENERATOR Z101. (See figure 7-2.) The spectrum generator performs the function of generating both broad-band and discrete frequencies

for use in the frequency translation sections, and consists of the 1 MHz output circuit; the 1 MHz spectrum generator; the 100 kHz spectrum generator; and five discrete frequency generators.

(1) In the 1 MHz output circuit, the 1 MHz frequency standard from Z301 in the power supply assembly is coupled through capacitor C5 to 1 MHz output amplifier Q1, whose collector is tuned by the combination of the primary winding of transformer T1 and capacitor C2. The 1 MHz low-impedance output signal from the T1 secondary is supplied to 1 MHz OUT jack J120, and through isolation resistor R128 to 1 MHz MON jack J121. (See figure 7-1.) In addition, the 1 MHz output is applied through Level Adjust potentiometer R60 (figure 7-2) to single mixer-divider Z104 and to carrier generator Z109.

(2) In the 1 MHz spectrum generator circuit, the 1 MHz standard input is coupled through capacitor C8 to the input of 1 MHz squarewave generator Q2. This stage essentially reacts as an over-driven amplifier with inverse feedback introduced by resistor R6. The output squarewave is coupled through C9 and is amplified by 1 MHz spectrum output amplifier Q3. This output signal consists of the 1 MHz fundamental frequency, plus harmonics, and is applied to the discrete frequency generator circuits.

(3) The 100 kHz spectrum generator consists of 1 MHz clipper Q14, driver amplifier Q17, decade divider Z1, 100 kHz spectrum generator Q15 and emitter follower Q16. The 1 MHz frequency standard is coupled to the input of 1 MHz clipper Q14, an over-driven amplifier similar to squarewave generator Q2; the collector output signal is amplified by driver Q17 and applied to divider decade Z1, a type NW135 integrated circuit (IC). Zener diode CR1 regulates Z1 operating voltage at 12 volts dc. The resultant 100 kHz squarewave output from Z1 is coupled through capacitor C69 to 100 kHz spectrum generator Q15, which amplifies the 100 kHz signal and sends it to output emitter follower Q16. This last stage provides the required low output impedance for comb filter sections Z102 and Z103 and effectively isolates the spectrum generator from undesirable load changes.

(4) The discrete frequency generator section consists of four similar frequency determining circuits plus a frequency multiplier network. These circuits produce discrete frequencies of 8 MHz, 12 MHz, 13 MHz, 14 MHz and 40 MHz. Since the principle of operation for each circuit is the same, only the 8 MHz and subsequent frequency multiplier circuits are discussed.

The output signal from the 1 MHz spectrum generator circuit is applied across the 8 MHz series resonant circuit formed by 8 MHz crystal Y3, trimmer capacitors C64 and C73, capacitor C72, resistor R64 and the base-emitter junction of harmonic select amplifier Q12. Since the 8th harmonic is present in the 1 MHz spectrum, crystal Y3 oscillates at 8 MHz; this input signal is amplified and applied to the tuned collector circuit consisting of trans-

former T10 and capacitor C75. Being a parallel tuned circuit, this combination is highly selective and rejects all other frequencies; resistor R53 provides the required regenerative feedback to reinforce or sustain oscillations at 8 MHz. The 8 MHz output signal from transformer T10 is coupled through capacitor C78 to 8 MHz output amplifier Q13. The tuned collector output is transferred, via the secondary winding of T11, to the inputs of single mixer-divider Z104, dual mixer-divider Z105 and final mixer Z106. The 8 MHz signal is also coupled through C83 to the frequency multiplier circuit. Discrete frequencies of 12 MHz, 13 MHz and 14 MHz are formulated in a similar manner; and applied to the step generator circuits, Z110 and Z113. It should be noted that +12 vdc is applied to the 13 MHz generator only when the selected frequency is above 12 MHz. (See figure 7-1.)

The 40 MHz frequency multiplier circuit consists of emitter follower Q18 and X5 amplifier Q19. The 8 MHz output from Q18 is directly coupled to X5 amplifier Q19, whose collector circuit is L-C tuned to the 5th multiple of 8 MHz, or 40 MHz. The output signal developed across isolation transformer T12 and tuned by C89 to 40 MHz, is coupled through capacitor C90 and supplied to frequency translator Z112.

b. COMB FILTERS A (Z102) and B (Z103). (See figures 7-3 and 7-4.) Each of the comb filter boards contain six independent discrete frequency generators; comb filter A, Z102, provides generation of frequencies from 0.8 MHz to 1.8 MHz in 0.2 MHz steps, while comb filter B, Z103, provides generation of frequencies from 0.9 MHz to 1.9 MHz in 0.2 MHz steps. As a result, 12 discrete frequencies are provided, at 100 kHz intervals, from 0.8 MHz to 1.9 MHz.

The circuit configuration and operation for each frequency generator is the same; for example, the 0.8 MHz circuit (figure 7-3) consists of 0.8 MHz crystal Y6, 0.8 MHz amplifier Q11 and 0.8 MHz output amplifier Q12. Upon receipt of the 100 kHz spectrum signal from spectrum generator Z101, the circuit oscillates at the eighth harmonic and thus produces 0.8 MHz in the same manner as discussed for the 8 MHz discrete frequency generator. (Refer to paragraph 4-3a. (4).) Level Adjust potentiometer R42 varies the gain of 0.8 MHz output amplifier Q12, and thus the overall amplitude of the 0.8 MHz output signal at pin S of J102.

c. FREQUENCY SELECT SWITCHING. (See figure 7-1.) Frequency select switching in the MMX()-2 is accomplished by six rotary switches S102 through S107, with direct-reading dials, corresponding to frequencies of 100 Hz, 1 kHz, 10 kHz, 100 kHz, 1 MHz and 10 MHz, respectively. (See figure 5-2.) The six discrete frequencies, generated on each of the comb filter boards, Z102 and Z103, are applied through 100-ohm series isolation resistors on respective terminal boards TB101 and TB102, prior to being sent to the selector switch networks.

Each of the first four selector switches (S102 through S105) receives 10 of the 12 discrete frequencies (1.0 MHz to 1.9 MHz) from terminal boards TB101 and TB102, and distributes them to single mixer-divider Z104, dual mixer-divider Z105, and to final mixer Z106. All 12 discrete frequencies (0.8 MHz to 1.9 MHz) are applied to switch S106 (1 MHz), and are distributed by switch S107 (10 MHz) to step generator A, Z110, for translation. The remaining decks of switches S105, S106 and S107 perform the function of enabling appropriate circuits in step generator A, Z110, step generator B, Z111, translator Z112, step generator C, Z113 and output filter Z114.

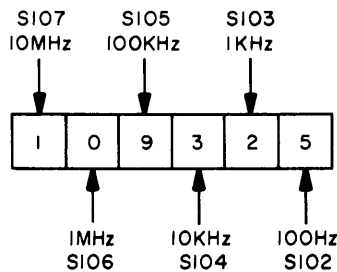

Figure 4-2. Frequency Selector Switch Readouts

d. MIXER DIVIDERS Z104 AND Z105, AND FINAL MIXER Z106. (See figures 7-5 through 7-7.) The mixer-dividers and final mixer are essentially frequency shift modulators; their purpose is to shift a basic 8 MHz input signal such that a frequency component, as chosen by the frequency selector switches, is generated having four decimal places and representing hundreds (100 Hz) through one-hundred thousands (100 kHz). The circuits accomplish the task of shifting the fundamental 8 MHz signal through the use of tuned, balanced-modulator and amplifier circuits. Because the circuit configuration and principle of operation for each mixer-divider is similar, only mixer-divider Z104 is discussed. (See figure 7-5.)

The 8 MHz output from spectrum generator Z101 is supplied to the inputs of each mixer-divider (to both halves of Z105) and to the input of the final mixer. In mixer-divider Z104, the 8 MHz input is applied to 8 MHz collector-tuned amplifier Q1; the 8 MHz signal developed across the T1 primary/C6 tank circuit is transferred to a balanced modulator consisting of the T1 secondary, Balance potentiometer R7 and modulator CR1/CR2, a matched pair of DD139 diodes. The balanced modulator receives the standard 1.0 MHz output from spectrum generator Z101 and produces sum and difference frequencies while attenuating the two original frequencies; since the tuned primary of coupling transformer T2 is selective at 9 MHz, the sum of the two frequencies is transferred by coupling transformer T3 to the input of the first of two tuned 9 MHz amplifiers, Q2 and Q3. The tuned collector output developed across

coupling transformer T6 is applied to the second balanced modulator consisting of the T6 secondary, Balance potentiometer R23 and CR3/CR4.

The second balanced modulator receives a 1 MHz to 1.9 MHz input signal from 100 Hz selector switch S102, depending upon switch position (0 through 9). As a result, the 9 MHz signal is modulated as explained previously for 8 MHz, thereby resulting in a 10 MHz to 10.9 MHz signal. This output is tuned by transformers T7 through T11 and amplified by transistors Q4 and Q5. The 10 MHz to 10.9 MHz output signal from T11 is applied to Q6, the first of two direct-coupled clipper/driver stages. The output signal from Q6 is applied to divide-by-ten decade Z1, producing the resultant frequency of 1.0 to 1.09 MHz. This signal is applied to dual mixer-divider Z105.

Each half of dual mixer-divider Z105 (figure 7-6) is similar to Z104 and functions to produce a resultant output signal between 1.0 and 1.0999 MHz, thereby satisfying selector switches S103 (1 kHz) and S104 (10 kHz). Final mixer Z106 (figure 7-7) satisfies selector switch S105 (100 kHz) by modulating the 8 MHz signal with the 1.0 to 1.9999 MHz signal from Z105 to produce 9.0 to 9.0999 MHz; this signal is then modulated by the 1.0 to 1.9 MHz output from 100 kHz selector switch S105 to yield a 10.0 to 10.9999 MHz output to translator Z112. In the 0 to 4 positions of 100 kHz selector switch S105 (figure 7-1), +12 vdc is applied to final mixer Z106 through the tuned output network consisting of capacitors C36 and C48, and diodes CR5 and CR6; this network forms a high pass filter which effectively prevents the higher range of frequencies, 10 through 10.9999 MHz (positions 5 through 9 of switch S105), from appearing at the output. In positions 5 through 9 of switch S105, +12 vdc is applied to the circuit through an alternate pin (14), thereby making the tuned output filter inoperative.

e. STEP GENERATORS Z110, Z111 AND Z113. (See figures 7-8 through 7-10.) The step generator circuits receive the 12, 13, and 14 MHz frequencies from spectrum generator Z101 and the 0.8 to 1.7 MHz frequency range from 10 MHz selector switch S107. These inputs are amplified, mixed, filtered, and multiplied to obtain a 104 to 132 MHz frequency range which is applied to one input of translator Z112. Step generator Z110 receives 13 MHz and 14 MHz inputs which are applied to respective amplifier and mixer circuits. The 13 MHz frequency is amplified by Q9 and applied to the primary of tuned coupling transformer T17. Input signal amplitude is controlled by Level Adjust potentiometer R61. The 13 MHz output signal is developed across the balanced modulator consisting of the T17 secondary, Balance Adjust potentiometer R67 and matched DD139 diodes CR3 and CR4. Similarly, the 14 MHz input signal is amplified by transistor Q1 and applied to the balanced modulator in the collector circuit formed by transformer T1, Balance Adjust potentiometer R7 and matched diodes CR1 and CR2. The 0.8 to 1.7 MHz output from 10 MHz selector switch S107 (figure 7-1) is amplified by transistor Q5 and is coupled via transformer T9 to both the 13 and 14

MHz balanced modulators. At this point, the 13 and 14 MHz channels are each split into two identical sub-channels. Since each pair of sub-channels is similar in circuit configuration, only the 13 MHz section is discussed.

As previously mentioned, the balanced modulator produces the sum and difference frequencies while attenuating the two original frequencies; the sum and difference signals are coupled to the input tuned transformers, T18 and T25 of the respective 11.8 to 12.2 MHz, and 11.3 to 11.7 MHz sub-channels. Both T18 and T25 are tuned to a portion of the difference frequency range of 11.3 MHz to 12.2 MHz, with T25 passing the 11.3 to 11.7 MHz segment and T18 passing the 11.8 to 12.2 MHz segment. The 11.3 to 11.7 MHz range is tuned by transformers T26 through T31 and amplified by Q13 through Q15; the 11.8 to 12.2 MHz range is tuned by transformers T19 through T24 and amplified by Q10 through Q12. The 11.3 to 12.3 MHz frequency range is obtained from the series-connected secondary windings of transformers T24 and T31 and is supplied to step generator B (Z111).

The 14 MHz section is similarly split into sub-channels of 12.3 to 12.7 MHz and 12.8 to 13.2 MHz and supplied to step generator B, Z111. Depending upon the range value of the selected frequency, operating voltage of +12 vdc to the 13 MHz and 14 MHz circuits is controlled by 10 MHz frequency selector switch S107B (front) and 100 kHz selector switch S106C and E (rear), while a switched ground to the sub-channels is controlled by 100 kHz selector switch S106C (front). (See figure 7-1.)

(1) Step generator Z113 contains a frequency step circuit for the 12 MHz input, similar to the 13 and 14 MHz circuits previously described. (See figure 7-9.) The 12 MHz input is modulated by the 0.8 to 1.7 MHz input supplied from step generator Z110 in the tuned collector circuit of mixer Q14; the combination of crystal Y1 and trimmer capacitor C101 serves to filter the 12 MHz component of the modulated signal. At this point, the mixer output is split into twin sub-channels of 10.4 to 10.6 MHz and 10.7 to 11.2 MHz by the series of tuned transformers and amplifiers similar to those discussed for step generator Z110. Switched B+ voltage of +12 vdc is applied to either sub-channel, depending upon the range value of the selected frequency. The 10.4 to 11.2 MHz output is also applied to step generator B (Z111).

(2) Step generator B, Z111, contains three identical multiplier-amplifier circuits for the respective three frequency range inputs from step generator A, Z110 and step generator C, Z113. Consider the 52 to 56 MHz multiplier-amplifier consisting of Q1, Q2, bandpass filter FL1 and output amplifier Q3.

The 10.4 to 11.2 MHz output from Z113 is applied to the input of X5 multiplier Q1, whose tuned collector tank circuit T1/C3 produces the fifth harmonic, or a 52 to 56 MHz signal. This frequency

band is amplified in Q2 and the tuned output across the collector T2/C9 tank circuit is coupled through C11 to bandpass filter FL1. Filter FL1 effectively rejects all frequencies except the 52 to 56 MHz band, applying this signal to output amplifier Q3. The 52 to 56 MHz signal across tuned collector tank circuit T3/C19 is coupled through C21 to step generator C (Z113).

The 56.5 to 61 MHz multiplier-amplifier circuit operates in the same manner upon receipt of the 11.3 to 12.2 MHz input from step generator A, Z110, while a similar action takes place in the 61.5 to 66 MHz multiplier-amplifier circuit upon receipt of the 12.3 to 13.2 MHz input from Z110. Each of these three output frequency ranges are applied to the frequency translation circuits in step generator C, Z113. Operating voltage of +12 vdc is applied to each of the three multiplier-amplifier sections, depending upon the frequency range value set on the 10 MHz and 100 kHz selector switches. (See figure 7-1.)

(3) Step generator Z113 accepts the three frequency ranges produced in Z111 and, using separate multiplier-amplifier circuits, amplifies them to produce a resultant 104 to 132 MHz output frequency range; this output signal is applied to translator Z112. Since the three multiplier-amplifier circuits are identical, only the 52 to 56 MHz circuit need be discussed.

The 52 to 56 MHz input is coupled to the input of X2 multiplier Q1, whose collector tank circuit T1/C10 is tuned to the second harmonic, thereby producing a resultant frequency range of 104 to 112 MHz. This signal is then applied to the first of three cascade-connected amplifiers, Q2 through Q4, whose respective collector outputs are tuned by transformers T2 and T3 and the combination of L8 and C27/C28. The 104 to 112 MHz output signal is applied through summing resistor R127 to the input of 104 to 132 MHz amplifier Q13. The frequency ranges of 113 to 122 MHz and 123 to 132 MHz are produced in a similar manner; the 113 to 122 MHz output is applied through summing resistor R132 to the input of Q13, while the 123 to 132 MHz output is applied through resistor R133 to the input of Q13. As a result, Q13, a broadband amplifier, effectively sums the three input ranges producing a net output signal of 104 to 132 MHz from T10 in the collector circuit. This frequency band is coupled through capacitor C112 and a low-pass filter to translator Z112. Again, switched B+ voltage of +12 vdc is applied to each circuit depending upon the selected frequency.

f. CARRIER GENERATOR Z109. (See figure 7-11.) The carrier generator performs the function of producing a 250 kHz subcarrier frequency and a 2.75 MHz carrier frequency for translation to an AM, SSB, or ISB rf carrier signal of 3 MHz. The 250 kHz subcarrier and 2.75 MHz carrier is derived from the 1 MHz standard oscillator in the power supply assembly. The carrier generator includes a metering amplifier circuit for conversion of the USB and/or LSB audio signals to a proportional dc level for display on the front panel MONITOR meter. In addition,

an AM amplifier circuit is included for formulation of an amplitude-modulated 250 kHz sub-carrier when the MODE switch is in the AM position.

(1) In the 250 kHz channel of Z109, the 1 MHz standard input signal is supplied to amplifier Q13; the 1 MHz collector signal is applied to emitter-follower Q1 whose output is supplied to the first of two cascade-connected divide-by-2 integrated circuits (IC's) Z1 and Z2. The resultant 250 kHz square-wave output is both amplified by 250 kHz amplifier Q2, a transformer-coupled amplifier, and is also applied to X11 multiplier Q7 in the 2.75 MHz carrier channel. The signal developed across the secondary of transformer T1 is coupled through capacitor C8 to a second 250 kHz transformer-coupled amplifier, Q3; the 250 kHz output from the T2 secondary is coupled through capacitor C14 to emitter-follower Q4 and through C45 to the MODE switching network for distribution. The 250 kHz signal is also developed across the series combination of CW Level Adjust potentiometer R20 and resistor R21; the 250 kHz output from the junction of R20 and R21 is coupled through capacitor C44 to MODE switch S114B (rear) as the subcarrier frequency for CW operation. The 250 kHz output developed across Carrier Level Adjust potentiometer R27 in the emitter of Q4 is coupled through capacitor C16 to CARRIER control R102 for formulation of the 250 kHz pilot carrier reinsert signal. A switched ground input is supplied to the 250 kHz subcarrier generator section at the junction of resistors R22 and R23 from the ON position of the EXCITER switch, or from the PTT position of the EXCITER switch when the MIKE input is used. The switched ground is applied via the AM, USB, LSB and CW positions of the MODE switch and enables 250 kHz amplifiers Q2 and Q3. (Refer to paragraph 4-3 h. for a discussion of MODE switching.)

(2) In the 2.75 MHz channel of Z109, the 250 kHz output from Z2 is applied to X11 multiplier Q7; the resultant 2.75 MHz signal developed across the collector circuit consisting of transformer T3 and capacitor C22 is coupled to 2.75 MHz amplifier Q8 whose collector output is then supplied through 2.75 MHz bandpass filter FL1 to 2.75 MHz amplifier Q9. The 2.75 MHz output signal from the T4 secondary is applied to the converter section of frequency shift generator Z108 for translation to the assigned rf fundamental frequency of 3 MHz.

(3) The metering amplifier circuit of Z112 consists of meter amplifier Q5, emitter follower Q6 and the half-wave rectifier and filter output consisting of diode CR2 and capacitors C19 and C20. This circuit receives either microphone or 500-ohm line audio from the USB/LSB MIKE/LINE controls via the USB or LSB positions of METER switch S115A (rear), and provides conversion to a dc level proportional to signal amplitude for display on MONITOR meter M101. (See figure 7-1.)

(4) The AM amplifier section of Z109 performs the function of amplitude-modulating the 250 kHz subcarrier signal with audio intelligence in the 300 Hz to 7500 Hz range, and supplies it to the con-

verter section of frequency shift generator Z108, when the MODE switch is positioned at AM.

With the MODE switch in the AM position, the 250 kHz subcarrier is applied to the AM amplifier from S114A (rear); USB and/or LSB audio is supplied from the AM position of S114A (front) to the AM amplifier. The audio input is coupled through C32 to a conventional audio amplifier, Q10, whose collector output is fed to emitter follower Q11; this latter stage provides isolation between the modulator stage Q12 and the input audio amplifier. The audio output from Q11 is coupled through capacitor C38 to the emitter of modulator Q12. The 250 kHz subcarrier frequency is coupled to the base of modulator Q12 through capacitor C34, resistor R62 and capacitor C37. Since the emitter of Q12 is modulated with the audio signal, the resultant collector signal across the T5 primary and C39 consists of a 250 kHz subcarrier whose amplitude fluctuates at the audio signal rate. The 250 kHz amplitude-modulated signal at the T5 secondary is developed across AM Level Adjust R69, and coupled through C43 to the AM position of MODE switch S114C (rear). With S114 in the AM position, the 250 kHz AM signal is then routed to the 250 kHz input of the converter section of frequency shift generator Z108.

g. **SIDEBAND GENERATOR Z107.** (See figures 7-12 and 7-1.) The sideband generator contains upper and lower sideband circuits which are identical in configuration and operation. In addition, as shown on figure 7-12, the sideband generator also includes an audio preamplifier circuit. A 600-ohm to 500-ohm impedance matching circuit is also included for conversion of an external 600-ohm audio line input to a 500-ohm output when the mike input is not being used for AM, USB, LSB, or ISB operation.

(1) The audio preamplifier circuit consists of a cascode connected microphone input amplifier and isolation emitter follower, followed by two cascaded class A audio amplifier stages and an output emitter follower. Input audio in the range of 300 Hz to 7.5 kHz is coupled to the cascode pair, Q1 and Q2, which present a high input impedance of 47K-ohms to the external microphone. Capacitor C5 introduces degenerative feedback to audio input signals above 7.5 kHz. The audio signal developed across Level Adjust potentiometer R9 is R-C coupled to the first of two cascaded class A amplifiers Q3 and Q4. Bypassed emitter resistors in these stages introduce a small amount of degenerative feedback, thereby limiting distortion and improving the overall audio frequency response of the preamplifier section. The audio signal from output emitter following Q5 is coupled through C13 to the MIKE half of USB and LSB MIKE/LINE controls R104 and R105, respectively; the audio signal is then routed to MODE switch S114A (front) for distribution to either the upper or lower sideband generators in USB or LSB operation, to both of the sideband generators when independent sideband (ISB) operation is desired, or to the AM amplifier circuit when AM operation is desired. (See figure 7-1.)

(2) The SSB modulation circuit receives the audio input signal from the MODE switch; when the MODE switch is set to the USB or LSB positions, audio is channeled to the respective sideband generator audio input and is used to modulate the 250 kHz subcarrier input from carrier generator Z109. In the ISB position of the MODE switch, audio signals are channeled simultaneously to both of the sideband generators to institute independent sideband (ISB) operation.

In the USB circuit of Z107, input audio signals from MODE switch S114A (front) in the USB, or ISB positions, is coupled through capacitor C14 to audio emitter follower Q6; output signals at the emitter are R-C coupled to the balanced modulator consisting of diodes CR1 through CR4, where they are modulated by the 250 kHz subcarrier output signal from 250 kHz emitter follower Q9. The balanced modulator produces sum and difference frequency outputs, while the subcarrier and audio frequencies are attenuated. The sum and difference frequency output from the modulator are transformer-coupled via T1 to IF amplifier Q7. The sideband output at the collector of Q7 is coupled through C24 and USB filter FL1 to IF emitter follower Q8. In the upper sideband generator FL1 is tuned to the upper sideband frequency range from 250,300 Hz to 253,300 Hz (600-ohm line input) or 250,350 Hz to 257,500 Hz (microphone input). Conversely, in the lower sideband generator circuit, LSB filter FL2 is tuned to the lower sideband frequency range of 246,700 Hz to 249,700 Hz (600-ohm input) or 242,500 Hz to 249,650 Hz (microphone operation). The filter consisting of the T1 primary capacitors C20 and C50, and trimmer capacitor C52, presents a decided notch at 250 kHz, thereby fully suppressing the 250 kHz subcarrier center frequency. The sideband output from emitter follower Q8 is coupled through capacitor C28 and isolation resistor

R72 to MODE switch S114C (rear) for carrier reinsertion. (Refer to paragraph 4-3 h.)

h. MODE SWITCHING. (See figures 4-3, 4-4 and 7-1.) Mode switching for the MMX()-2 is accomplished by MODE switch S114, which selects the desired mode of operation (AM, USB, LSB, ISB, CW, FSK and FAX) by routing audio, subcarrier and certain enables to the proper circuits of the Exciter. Mode switching can be divided into areas of audio, present in the AM, USB, LSB and ISB modes, and the remaining modes of CW, FSK and FAX operation.

(1) In the audio modes (figure 4-3), microphone or 500-ohm line audio inputs from the upper and/or lower sideband generators are developed across half of the respective MIKE/LINE control and sent to MODE switch S114A (front). Consider upper sideband (USB) audio. Microphone audio from the audio preamplifier circuit is developed across the MIKE half of USB MIKE/LINE control R104 and is applied to contact 2 of S114A; when the 500-ohm audio input line is used, the USB generator (figure 7-3) supplies a 500-ohm line audio output which is developed across the LINE half of control R104. In either case, USB MIKE/LINE control R104 sets the amplitude of the USB audio signal. With the MODE switch in the AM position, the USB audio is coupled through contact 3 of S114C and R112 to the AM amplifier in carrier generator Z109; in the USB position, the audio is coupled through contact 4 of S114C to the upper sideband generator audio input; in the LSB position, LSB audio from LSB MIKE/LINE control R105 is coupled through contacts 8/11 of S114C to the lower sideband generator audio input; and in the ISB position of S114C, both USB and LSB audio is sent simultaneously to the respective sideband generator audio input (if audio intelligence is desired on both).

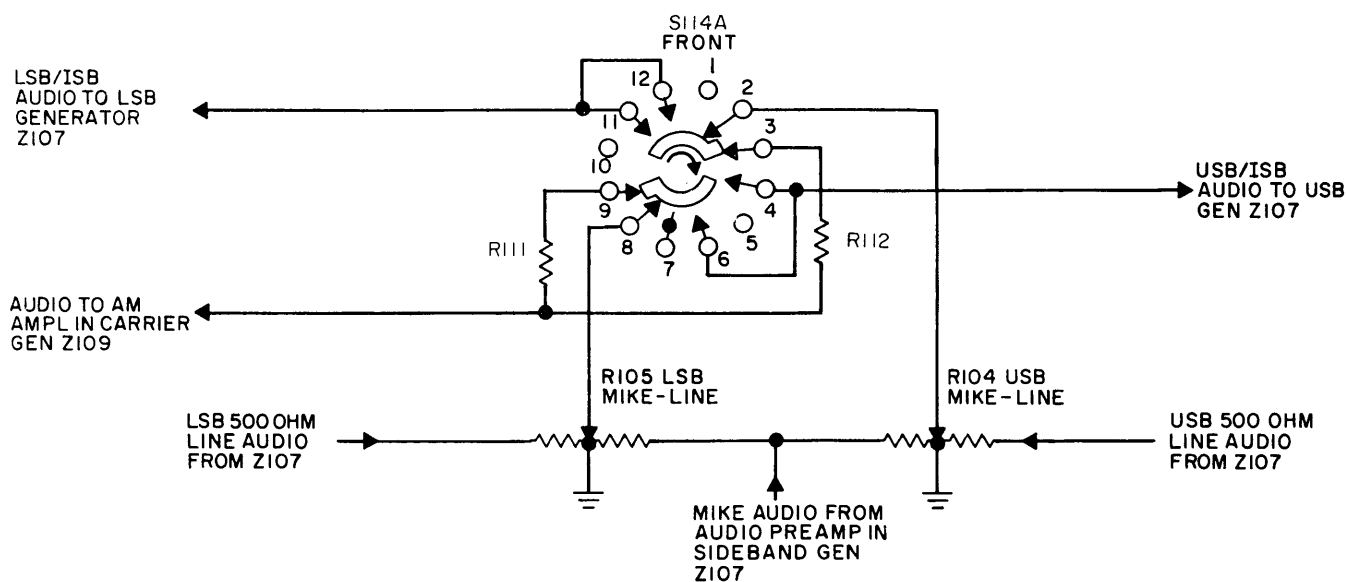

Figure 4-3. Audio Mode Switching, Simplified Schematic Diagram

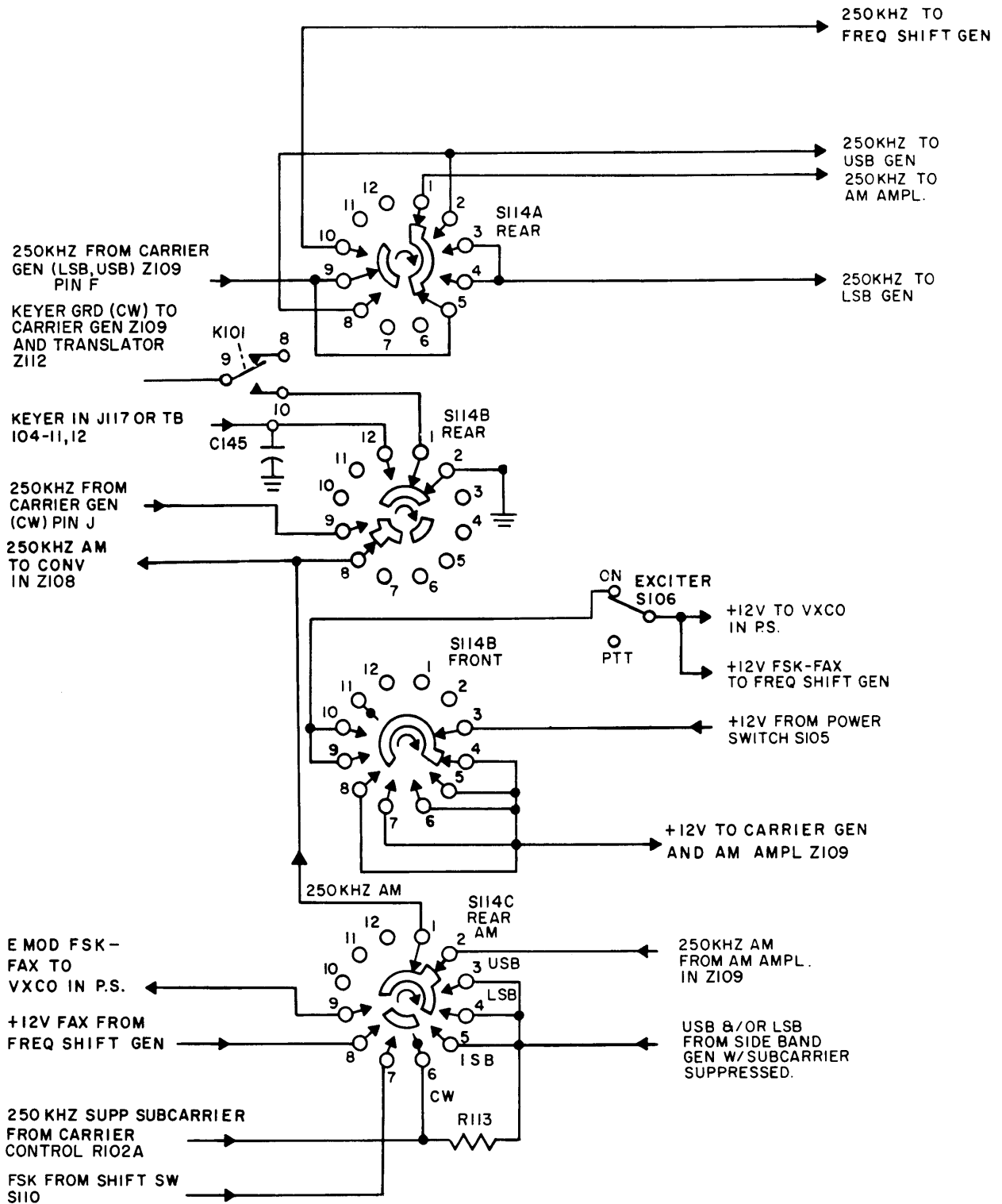

Figure 4-4. CW, FSK, and FAX Mode Switching, Simplified Schematic Diagram

(2) The remaining decks of MODE switch S114 (C rear, B front and rear, and A rear) perform independent functions such as 250 kHz subcarrier and AM distribution and reinsertion, and CW, FSK and FAX selection. (See figure 4-4.) The 250 kHz subcarrier output from carrier generator Z109 is applied to S114A (rear) at contacts 9 and 5. With the MODE switch in the AM position, the subcarrier is channeled to the AM amplifier in Z109; in the USB, LSB and ISB positions, the 250 kHz subcarrier is applied to either the respective sideband generator circuit in Z107, or to both sideband generator circuits simultaneously. Deck S114B (front) of the MODE switch distributes +12 vdc operating potential to 2.75 MHz carrier generator and AM amplifier circuits in Z109 in the AM, USB, LSB, ISB and CW positions. (See figure 7-1.) In the FSK and FAX positions, +12 vdc is routed through the ON position of EXCITER switch S113 to frequency shift generator Z108 and the 3 MHz variable crystal controlled oscillator (VXCO) in the power supply assembly. The amplitude-modulated 250 kHz output from the AM amplifier circuit in Z109 is supplied to the AM position of S114C (rear) and is supplied to the converter section of frequency shift generator Z111. In the USB, LSB and ISB positions of S114C, sideband audio intelligence, with a suppressed 250 kHz subcarrier, is supplied from either or both sideband generator circuits to contacts 3, 4 and 5. The SSSC input is added to the 250 kHz subcarrier signal from CARRIER control R102A through isolation resistor R113. The amount of subcarrier injection depends on the position of R102A and consists of continuously variable injection from zero (0) to full. When subcarrier injection is desired, the resultant USB and/or LSB audio intelligence is accompanied by a 250 kHz pilot carrier and is supplied to the converter section of Z108.

Frequency shift keyer (FSK) and facsimile (FAX) operation is controlled by S114C (rear). For FSK operation, a variable dc current, proportional either to the keyed 250 kHz subcarrier frequency, or to an external teletype input, is applied to contact 7 of S114C from SHIFT switch S110. This signal is routed to the variable crystal controlled oscillator (VXCO) in the power supply assembly, thereby causing a shift in frequency, above and below center frequency, which represents the marks and spaces. In FSK operation, a variable dc current from frequency shift generator Z108 is supplied to S114C at contact 8 and is routed to the VXCO. CW operation is controlled by S114B (rear), where a 250 kHz subcarrier frequency from the carrier generator is routed through contacts 9/8 to the converter section of Z108.

i. **FREQUENCY SHIFT GENERATOR Z108.** (See figure 4-5 and 7-13.) The frequency shift keyer consists of four distinct sections; namely the 2.75 kHz converter section, the 3 MHz carrier and VXCO buffer-amplifier, the FSK keyer and modulator, and the FAX circuit.

(1) The converter and ALDC circuit performs the function of translating a 250 kHz input signal to an rf output carrier of 3 MHz. The 250 kHz input can be an AM signal; USB and/or LSB intelli-

gence with, or without, the 250 kHz subcarrier suppressed; or an interrupted 250 kHz input at an external keyed rate in the CW mode. In addition, in the FSK and FAX modes, a variable crystal controlled frequency of 3 MHz is supplied to the 3 MHz converter buffer-amplifier circuit for translation, while the 2.75 MHz carrier and 250 kHz inputs are not used. As discussed previously, when the MODE switch is in the AM, USB, ISB or CW positions, the 2.75 MHz channel in the carrier generator is enabled and supplies the 2.75 MHz carrier frequency to the converter channel of Z108. This input is amplified by 2.75 MHz input stage Q1 and fed to 2.75 MHz emitter follower Q2; the output from Q2 is applied to balanced modulator Z1. In the AM position of MODE switch S114, the 250 kHz input consists simply of a 250 kHz subcarrier, amplitude-modulated by audio intelligence, in the 350 Hz to 7500 Hz range. When the AM signal is mixed with the 2.75 MHz input, the balanced modulator produces the sum and difference frequencies while attenuating the two original frequencies; the combination of tuned transformer T1 and capacitor C6 traps the 2.75 MHz signal. As a result, an amplitude-modulated sum frequency of 3 MHz results and is amplified by Q3. The collector output of Q3 is coupled through 3 MHz bandpass FL1 and is amplified by tuned-collector stage Q4. The 3 MHz AM tuned collector output of Q4 is developed across Level Adjust potentiometer R58 and is applied to translator Z112.

In the USB, LSB and ISB positions of MODE switch S114, the 250 kHz input to the converter section consists of upper and/or lower sideband audio intelligence in the 300 to 3300 Hz (600-ohm line input) or the 350 to 7500 Hz (microphone input) ranges with the 250 kHz carrier suppressed or unsuppressed, according to the position of CARRIER control R102. These signals are obtained from S114C (rear). Since the 2.75 MHz rf carrier input is also present in these modes, the balanced modulator produces upper and/or lower sideband signals with a center frequency of 3 MHz. If the 250 kHz subcarrier is suppressed, so also is the 3 MHz rf carrier -- the sum frequency of 2.75 MHz and 250 kHz. The upper and/or lower sideband signals are amplified in the same manner as the AM signal, and are sent to translator Z112.

In the CW position of MODE switch S114, the 250 kHz input is not modulated by audio intelligence, but is interrupted at a rate determined by a keyer input at KEY jack J117 or at terminals 11 and 12 of TB103 on the rear panel of the Exciter. This results in a keyed difference frequency of 3 MHz in the balanced modulator. The CW rf is then amplified as before and sent to the translator.

In the FSK and FAX modes of operation, the 3 MHz variable crystal controlled oscillator (VXCO) is enabled in the power supply assembly, and its frequency is varied by the dc current produced in the FSK and FAX circuit of the frequency shift generator. Since both the 250 kHz (AM, USB/LSB or CW) and 2.75 MHz inputs are inhibited in these modes, the 3 MHz FSK-FAX input is coupled directly to the input of 3 MHz amplifier Q12 in the VXCO buffer-amplifier, thus by-passing the 2.75 MHz amplifier and balanced modulator circuit.

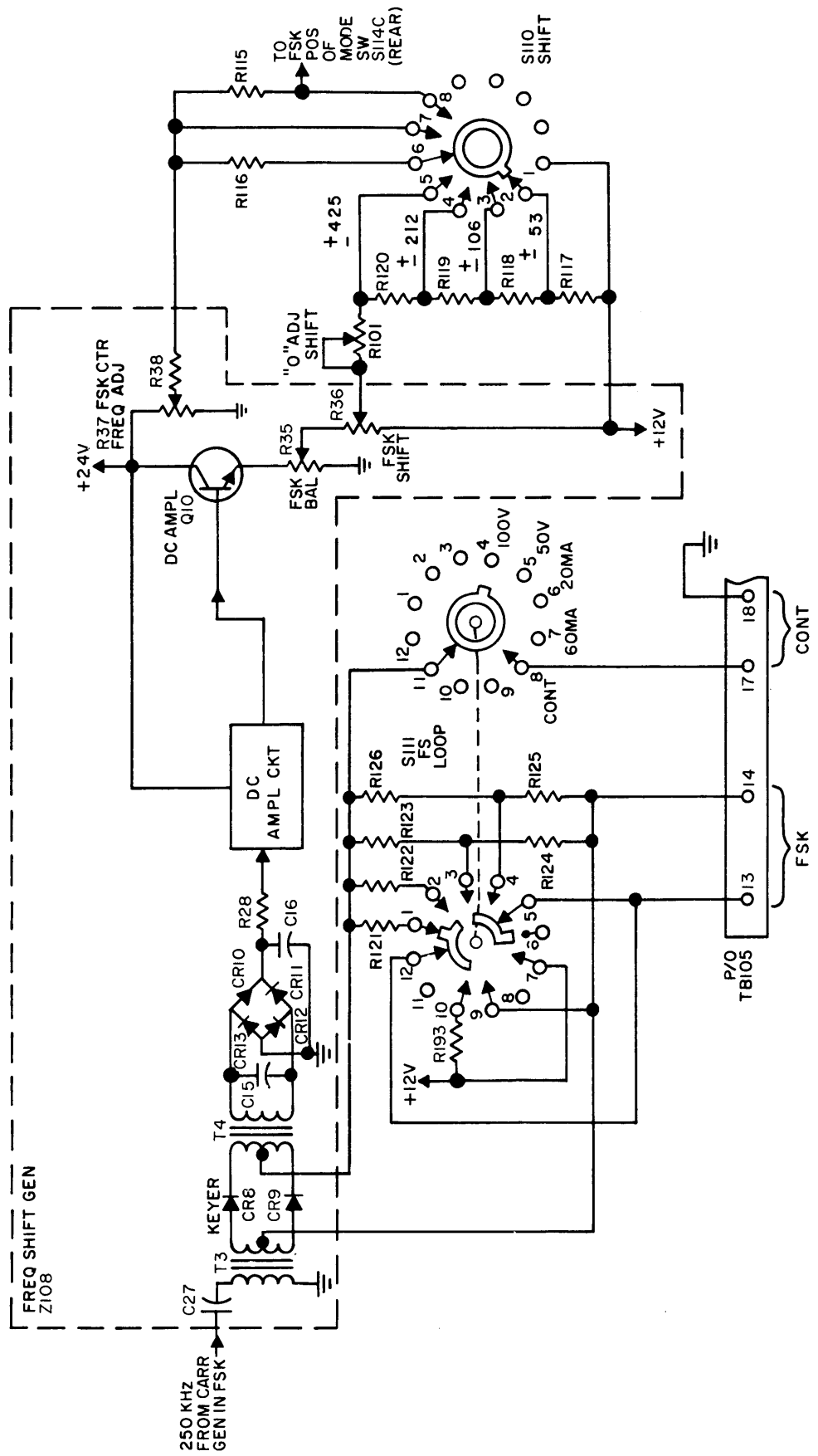

Figure 4-5. Frequency Shift Keyer Circuit, Simplified Schematic Diagram

(2) Both FSK and FAX operation is initiated when MODE switch S114B (front) is set to either the FSK or FAX position as previously indicated in the discussion of MODE switching. In either of these positions, S114B supplies a +12 vdc enable to both the 3 MHz crystal controlled oscillator Z302 in the power supply assembly, and to the 3 MHz buffer-amplifier circuit in frequency shift generator Z111. With MODE switch S114 in the FSK position, S114A (rear) routes the 250 kHz subcarrier frequency from carrier generator Z109 to the frequency shift generator keyer circuit consisting of coupling transformers T3/T4 and keyer diodes CR8/CR9. The keyer circuit is, in effect, a modulator, in that the 250 kHz input is interrupted by a dc current representing marks and spaces from an externally connected dry-contact keyer or teletype at terminals 13 and 14 of TB105. (See figure 4-5.) The keyer input is connected to the modulator through FS LOOP switch S111 which is set to the 100V or 50V positions when dry contacting keying is used, and to the 20 mA or 60 mA positions to match the dc battery loop when a teletype keyed input is used. The external keying rate is 200 WPM and 75 bauds. By keying the 250 kHz subcarrier, a frequency shift above and below center frequency is obtained, corresponding to the marks and spaces of the teletype input. This signal is coupled through T4 to the full-wave bridge rectifier consisting of diodes CR10 through CR13; the resultant varying dc signal is then applied to a series of three dc amplifiers, Q7 through Q9, and an output emitter-follower, Q10. (See figure 7-13.) Amplifier Q8 is inserted in the circuit when dc SENSE switch S109 is in the + position; otherwise, in the - position, Q8 is bypassed. The variable dc output is developed across FSK Shift potentiometer R36; the dc output is coupled to SHIFT switch S110. FSK Center Frequency Adjust potentiometer R37 sets the average level about which the dc signal varies, and thus the center frequency of the VXCO in the power supply assembly. Dc regulator Q5 provides a regulated 24 vdc to the dc amplifier circuit from the +24 vdc supply input line; regulator Q11 supplies a regulated +12 vdc to SHIFT switch S110 and R36 from the +12 vdc MODE switch input. SHIFT switch S110 effectively sets the amplitude of the dc signal varying about the average dc level as set by R37. By changing the maximum amplitude, the shift in VXCO output frequency is correspondingly changed to provide the desired shift above and below center frequency. The varying dc output from the SHIFT switch is coupled through the FSK position of MODE switch S114C and sent to the 3 MHz VXCO in the power supply assembly.

With +12 vdc applied to 3 MHz oscillator Z302, and with the variable dc input present, representing keyer frequency shift, the frequency of Z302 varies about the 3 MHz center frequency by an amount dictated by SHIFT switch S110. This shifted frequency is applied to the buffer-amplifier section of frequency shift generator Z108. The input signal is amplified in buffer Q12, and applied to limiter Z1 which maintains amplitude within acceptable limits without destroying the frequency shift characteristics. The limiter output is applied to emitter

follower Q13 and then through 3 MHz Level Adjust potentiometer R46 to the 3 MHz converter section.

IN FAX operation, an externally applied facsimile input at terminals 15 and 16 is applied to dc regulator Q6. The facsimile input is a variable dc voltage and causes a shift in output voltage across FAX balance potentiometer R25. This varying voltage is developed across FAX Shift potentiometer R27 and is sent to the FAX position of MODE switch S114C (rear). When FAX is selected, this dc signal then modulates the VXCO in the power supply assembly in the same manner as FSK operation.

j. TRANSLATOR Z112. (See figure 7-14.) Translator Z112 receives the 3 MHz signal from the frequency shift generator Z108; the 40 MHz signal from spectrum generator Z101; the 10 to 10.9999 MHz signal from the final mixer Z106; and the 104 to 132 MHz signal from step generator Z113. These signals are effectively shifted or translated to produce an output frequency range from 1.6 to 29.9999 MHz, depending upon the selected rf output frequency.

The 10 to 10.9999 MHz selectable frequency range input is applied to balanced mixer Q12, developed across the tuned collector tank circuit, T12/C81, and coupled to the balanced modulator consisting of the T12 secondary, Balance Adjust potentiometer R71 and matched HP8403 diodes CR4 and CR5. With the 3 MHz input coupled to the balanced modulator via transformer T14 and C50, the modulator outputs the sum and difference frequencies while attenuating the two original frequencies; this output is applied to tuned coupling transformer T13 in the 13 to 13.5 MHz circuit, and to tuned coupling transformer T19 in the 13.5 to 14 MHz circuit. With T13 and T15 tuned to the lower half of the sum frequency, a 13.0 to 13.5 MHz signal is applied to a series of two amplifiers, Q13 and Q14, tuned by transformers T16 through T18. Similarly, with transformers T19 and T20 tuned to the upper half of the sum frequency, a 13.5 to 13.9999 MHz signal is applied to amplifiers Q18 and Q19, and tuned by transformers T21 through T23. The upper half of the frequency range is then applied to the secondary of transformer T18; combined with the lower half of the frequency range developed across the primary; and applied to balanced modulator transformer T6 in the 40 MHz multiplier-amplifier section. The Automatic Load and Drive Control (ALDC) circuit consisting of Q15, Q16 and Q17, receives the ALDC level from RF output Z115. This circuit supplies each of the 13 to 13.9999 MHz circuits with a control voltage to maintain a relatively constant net output signal at the secondary of T18. The combination of modulator diode CR4 and resistor R77 effectively isolates the ALDC circuit from the input circuit to the 13 to 13.5 MHz and 13.5 to 13.9999 MHz amplifier sections.

The 40 MHz input from spectrum generator Z101 is applied to a series of three tuned amplifiers, Q1 through Q3; the tuned collector output from 40 MHz amplifier Q3 is coupled from the secondary of T3 through capacitor C16 to X3 multiplier Q4, there-

by resulting in an output frequency of 120 MHz across transformer T4 in the tuned collector circuit. This signal is amplified and tuned in stages Q5 and Q6 and applied across the tuned collector circuit consisting of the T6 primary and trimmer capacitor C31. The 120 MHz signal is then coupled to the balanced modulator consisting of the T6 secondary, Balance Adjust potentiometer R36 and matched HP8403 diodes CR1 and CR2. As a result, the 120 MHz signal is modulated by the 13 to 13.9999 MHz signal from the secondary of transformer T18, resulting in the sum, difference and two original frequencies. With the secondary of transformer T7 tuned to the sum frequency, a signal range of 133 to 133.9999 MHz results; this signal is amplified by four subsequent tuned amplifier stages, Q7 through Q10, and is coupled to the anode of mixer diode CR3.

At this point, the 104 to 132 MHz signal from step generator Z113 is coupled through capacitor C10 to the cathode of mixer diode CR3, thereby resulting in a difference range of 1.0 to 29.9999 MHz. This signal is applied to a two-section L-type inductive filter consisting of inductors L17 and L19, and capacitors C64 and C65, which provide sharp frequency rolloff below 1.6 MHz; thus a 1.6 to 29.9999 MHz results and is coupled through C66 to 1.6 to 29.9999 MHz output amplifier Q11. The collector output developed across autotransformer T11 is coupled through C70 to RF OUTPUT control R103 (figure 7-1). Switched +12 vdc inputs are applied to the translator circuits, depending upon the selected range value of rf output frequency.

k. **RF OUTPUT Z115 AND METERING CIRCUIT.** (See figure 7-1.) RF output Z115 consists of three rf stages, Q1 through Q3. The 1.6 to 29.9999 MHz input frequency range from the RF OUTPUT control is applied to cascade amplifier Q3 through a dual LC filter consisting of L7, L24, C20 and C39. Potentiometer R1 establishes the operating bias of the input stage, while RF OUTPUT control R103 sets the desired input signal amplitude. The collector output of Q3 is coupled through C9 and autotransformer T1 to the first of two cascade-connected rf amplifiers Q2/Q1. The 1.6 to 29.9999 MHz signal output from Q1 is coupled through C14 and applied to filter network Z114 and to the rf metering and ALDC circuits. The signal to the metering circuit is coupled through isolation resistor R17 and capacitor C37 to diode CR2 which rectifies the negative half-cycle; the positive half-cycle is then filtered to produce a dc level proportional to the amplitude of the rf output. This level is supplied to MONITOR meter M101 when METER switch S115 is in the RF position.

In the metering circuit (figure 7-1), +30 vdc from the power supply assembly is coupled to METER switch S115B and through dropping resistors R108 through R110 to S115A and to rf output circuit Z115. Therefore, MONITOR meter M101 is effectively placed in series with the collectors of each rf amplifier and the B+ supply voltage, thereby monitoring respective collector current of each amplifier when METER switch S115 is set to the Q1 (350 ma), Q2 (130 ma) or

Q3 (65 ma) position. Potentiometer R106 provides a means of calibrating MONITOR meter M101. In all other positions (USB, CARR and RF) of switch S115, one side of meter M101 is returned to ground through S115A, while S115B connects the other side of the meter to the respective USB, CARR or RF output. In these positions, the MONITOR meter displays relative amplitude of the output signals.

1. **OUTPUT FILTER Z114.** (See figure 7-16.) Output filter Z114 contains six relay controlled bandpass filters, with each relay returned to the appropriate positions on the 10 MHz (S107), 1 MHz (S106) and 100 kHz (S104) switches relative to the selected rf output frequency. As a result, the switch-selected frequency is filtered by an appropriate L-C network prior to appearing at RF OUT jack J124 and MON jack J125. (See figure 7-1.) The four upper bandpass filters are tuned by trimmer capacitors. Table 4-1 presents a listing of each bandpass filter control relay and the corresponding frequency range it controls.

TABLE 4-1. OUTPUT FILTER PASS BANDS AND CONTROL RELAYS

Control Relay	Filter Bandpass Frequency
K1	1.6 MHz - 2.5 MHz
K2	2.5 MHz - 4.0 MHz
K3	4.0 MHz - 7.0 MHz
K4	7.0 MHz - 12.0 MHz
K5	12.0 MHz - 20.0 MHz
K6	20.0 MHz - 29.9999 MHz

m. **POWER SUPPLY ASSEMBLY.** (See figures 7-17 through 7-19.) Three subassemblies are incorporated into the power supply; namely, rectifier and filter capacitor Board (A) Z304, regulator Z303, and heat sink Z305. (See figure 7-13.) Also included is power transformer T301, 1 MHz standard oscillator Z301 and 3 MHz VXCO Z302. Input power of either 115 or 230 vac is supplied to power transformer T301 via power input jack J116 and line fuses F101 and F102. For 115-volt operation, the primaries of T301 are connected in parallel and line fuses of 1.0-ampere value are used; for 230-volt operation, the primaries of T301 are connected in series and fuse value is 0.5 ampere. The secondary output voltage, approximately 60 vac, is applied to the full-wave bridge rectifier on Z304 (figure 7-18). The rectified output voltage of 40 vdc is filtered by C4 and applied to regulator Z303. The centertap voltage from T301, approximately 30 vac, is filtered by capacitor C3 and also applied as +20 volts to regulator Z303.

The +40 volt input to regulator Z303 (figure 7-19) is developed across the combination of voltage reference diode CR5 and 24V Current Adjust po-

tentiometer R12, thus providing a stable positive reference input to overcurrent amplifier Q6. As a result, Q6 conducts by an amount proportional to the setting of R12, and causes regulator drivers Q2 and Q3 to conduct, which, in turn, cause respective series regulators Q302 and Q303 to conduct on heat sink Z305. The supply collector current drawn by regulator Q302 is sensed by the R15, R19 and CR2 network in the emitter circuit of over-current amplifier Q6, thereby establishing a current reference in conjunction with the bias applied to the base via R12. Series regulator Q302 furnishes a +30 vdc output, while regulator Q303 supplies +24 vdc.

Fluctuations in the +24 vdc output of Q303 is applied to a resistive divider consisting of R6, +24V Adjust potentiometer R18, and R16; R18 applies this

positive voltage to dc amplifier Q7. Since the emitter of Q7 is maintained at a constant +15 vdc potential by zener diode CR7, variations in the output voltage, when compared with this stable reference, cause Q7 to provide more or less drive current to regulator drivers Q2 and Q3. As a result, the +24 vdc and +30 vdc outputs are maintained at relatively nominal values. The +12 vdc regulator, consisting of Q1, Q4, Q5 and Q301, is similar in operation to the +24 vdc/+30 vdc regulators.

The +30 vdc output from the power supply assembly (figure 7-17) is applied to output filter Z114 and to METER switch S115; the +24 vdc and +12 vdc outputs are applied to ON-STANDBY switch S112. (See figure 7-1.)

SECTION 5
MAINTENANCE

5-1. PREVENTIVE MAINTENANCE

The following paragraphs describe procedures to inspect, check and clean the components of the MMX()-2. In general, preventive maintenance provides a basis for recognizing future probable causes of equipment malfunction in the early stages of deterioration. Many such causes are apparent to the senses of sight, touch and smell. Therefore, by adhering to a stringent program of preventive maintenance, involving periodic inspection and checks, the most probable causes of equipment malfunction can be avoided, thereby minimizing equipment downtime and the possibility of compromising important schedules. Paragraph 5-3b presents a listing of test equipment required for MMX()-2 maintenance.

a. INSPECTION AND TEST. The following paragraphs describe equipment inspection and power supply checks to be performed on a weekly basis.

(1) General Inspection. A most important and least expensive tool in the preventive maintenance program is the sense of sight; a thorough visual inspection of an assembly or component for tell-tale signs of deterioration prior to failure can save hours of test and troubleshooting time after a complete breakdown. Table 5-1 presents a weekly inspection checklist for the MMX()-2.

TABLE 5-1. WEEKLY INSPECTION ROUTINE

Assembly or Subassembly	Check
Line Power Cord	Check three-wire line power cord for cracks, nicks or fraying.
Main Chassis Assemblies	<ol style="list-style-type: none"> 1. Check underside of chassis for dirt and dust. 2. Check all inter-connector wiring for nicks, cracks or fraying. 3. Check all printed circuit boards for cracks; check components for looseness and evidence of deterioration from possible overheating. 4. Check printed circuit board jacks for tightness against chassis.

TABLE 5-1. WEEKLY INSPECTION ROUTINE (cont)

Assembly or Subassembly	Check
Main Chassis Assemblies (cont)	5. Check ground connections for security.
Front and Rear Panels	<ol style="list-style-type: none"> 1. Check panel for general cleanliness. 2. Check all control knobs for smooth action from limit-to-limit. Check all switches for positive action. 3. Check MONITOR meter face for cracks, scratches, etc. 4. Check indicator faces for cracks. 5. Remove line fuses and check for proper 1-ampere or 0.5-ampere value and condition (0.5-ampere with 230 vac line). 6. Check all input/output jacks for security against panel.

(2) Power Supply Checks. Perform the power supply checks on a weekly basis as follows:

(a) Check that line power cord is not plugged into 115 or 230 vac sources.

(b) Unplug power supply regulator board Z303 from its receptacle at the rear center of the chassis; insert the small extender board in the vacated receptacle and mount the regulator board on the extender board.

(c) Check that POWER switch on front panel is in STANDBY position and connect line power cord to 115 or 230 vac source as applicable.

(d) Using a VTVM, HP 410B, or equivalent, check dc voltage at pin F of Z303; voltage should be +12 vdc $\pm 1\%$.

(e) Check voltage at pin 4 of Z303; voltage should be +24 vdc $\pm 1\%$.

(f) Check voltage at pin 3 of Z303; voltage should be +30 vdc $\pm 1\%$.

(g) Remove line cord from power source, and replace regulator board into mating jack J303 after removing extender board.

(3) **Functional Test.** Perform the check-out procedure for the MMX()-2 outlined in Section 2, paragraph 2-5, on a weekly basis, after a check has been made of the power supplies.

b. **CLEANING INSTRUCTIONS.** In general, the MMX()-2 should be cleaned once a week, using a soft camel's hair brush, forced air pressure of not more than 20 psi and a suitable cleaning agent such as trichlorethylene or methylchloroform.

WARNING

When using toxic solvents, make certain that adequate ventilation is provided; prolonged or repeated breathing of the vapor shall be avoided. Avoid prolonged or repeated contact with skin. Flammable solvents shall not be used on energized equipment or near other equipment from which a spark may be received.

CAUTION

Trichlorethylene contains a paint removing solvent; avoid contact with painted surfaces.

Remove dirt or grease from wiring and chassis surfaces using cleaning solvent; dry with compressed air. Remove dust from printed circuit boards

using a soft camel's hair brush. Blow out accumulated dust from inaccessible areas of chassis using forced air.

5-2. TROUBLESHOOTING

The circuits of the MMX()-2 are contained on 17 PC boards accessible from the top of the chassis. The card Zxxx numbers are the circuit reference designation prefix. Numbers prefixed with an "A" are the PC assembly part numbers by which they are identified and ordered. The "Z" prefix number is silkscreened both on the card and on the chassis adjacent to the PC board receptacle. Some PC boards in the MMX()-2 and in other TMC equipment, although they are assigned different "Z" designations, have the same assembly "A" prefix and are thus identical and interchangeable. These PC boards have similar keying at their plug ends and mating receptacles. The power supply assembly heat sink is mounted against the rear wall of the chassis; the smaller power supply boards are mounted forward of the heat sink and are removable.

In general, a malfunction of the MMX()-2 will usually manifest itself by lack of, or improper readings on the MONITOR meter, and can be quickly localized to a particular printed circuit board by the logical process of elimination. If a second MMX()-2 is obtainable, or a set of spare PC boards is available, troubleshooting can be facilitated by the board substitution method. In some instances, a particular board may require alignment or adjustment as outlined in paragraph 5-2. Table 5-2 presents a troubleshooting chart for the MMX()-2; figures 5-1 and 5-2 show respective top and bottom views of the equipment.

TABLE 5-2. TROUBLESHOOTING CHART

Step	Trouble	Probable Cause	Remedy
1	No rf output at any selected frequency.	Check that POWER indicator is illuminated with POWER switch ON.	If lamp is not illuminated, check power supply voltages as outlined in paragraph 5-1 a.(2). If lamp is illuminated, proceed to step 2.
2		Check that STD switch is set to INT.	Set switch at INT. If switch is at INT, proceed to step 3.
3		Check for normal display on MONITOR with METER switch in Q1, Q2 and Q3 position.	If all readings are normal, proceed to step 4. If any reading is abnormal, replace Q1, Q2 or Q3 on rf output Z115 as indicated by meter reading.

TABLE 5-2. TROUBLESHOOTING CHART (Cont)

Step	Trouble	Probable Cause	Remedy
4		Check for 1 MHz output at 1 MHz MON jack on rear chassis.	If 1 MHz is present, proceed to step 5. If 1 MHz is not present, check for 1 MHz output at J302 on the power supply assembly. If not present, replace 1 MHz standard Z301.
5		Check for 1 MHz spectrum from 1 MHz spectrum generator on Z101.	If present, proceed to step 6, Troubleshoot 1 MHz spectrum generator and 1 MHz squarewave generator on Z101.
6		Check for 100 kHz spectrum output at pin D of Z101.	If present, proceed to step 7. Troubleshoot 100 kHz spectrum generator channel on Z101.
7		Check for 3 MHz input to translator Z112.	If not present, proceed to step 8. If present proceed to step 9.
8		Check for 2.75 MHz input to frequency shift generator Z108.	If not present, troubleshoot carrier generator Z109. If present, troubleshoot 3 MHz balanced mixer circuit.
9		Check for 10-11 MHz, 40 MHz, and 104 to 132 MHz input to translator Z112.	If 10-11 MHz input is missing, check final mixer Z106. If 40 MHz is missing, check spectrum generator Z101. If 104 to 132 MHz input is missing, check step generator Z113. If all inputs to translator Z112 are present, check transistor Q11 (1.6-30 MHz amplifier) located on Z112.

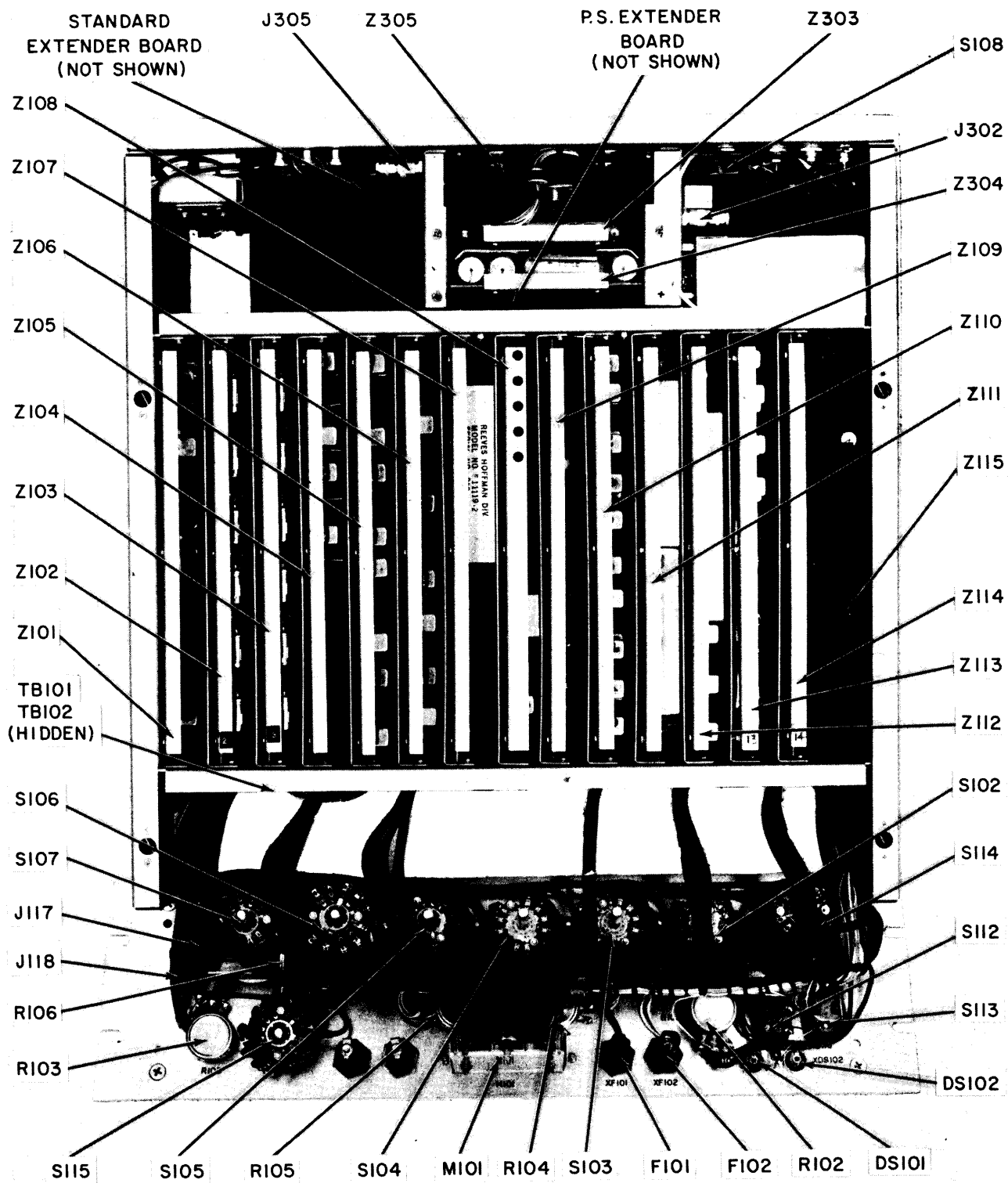

Figure 5-1. Top View, Location of Major Components

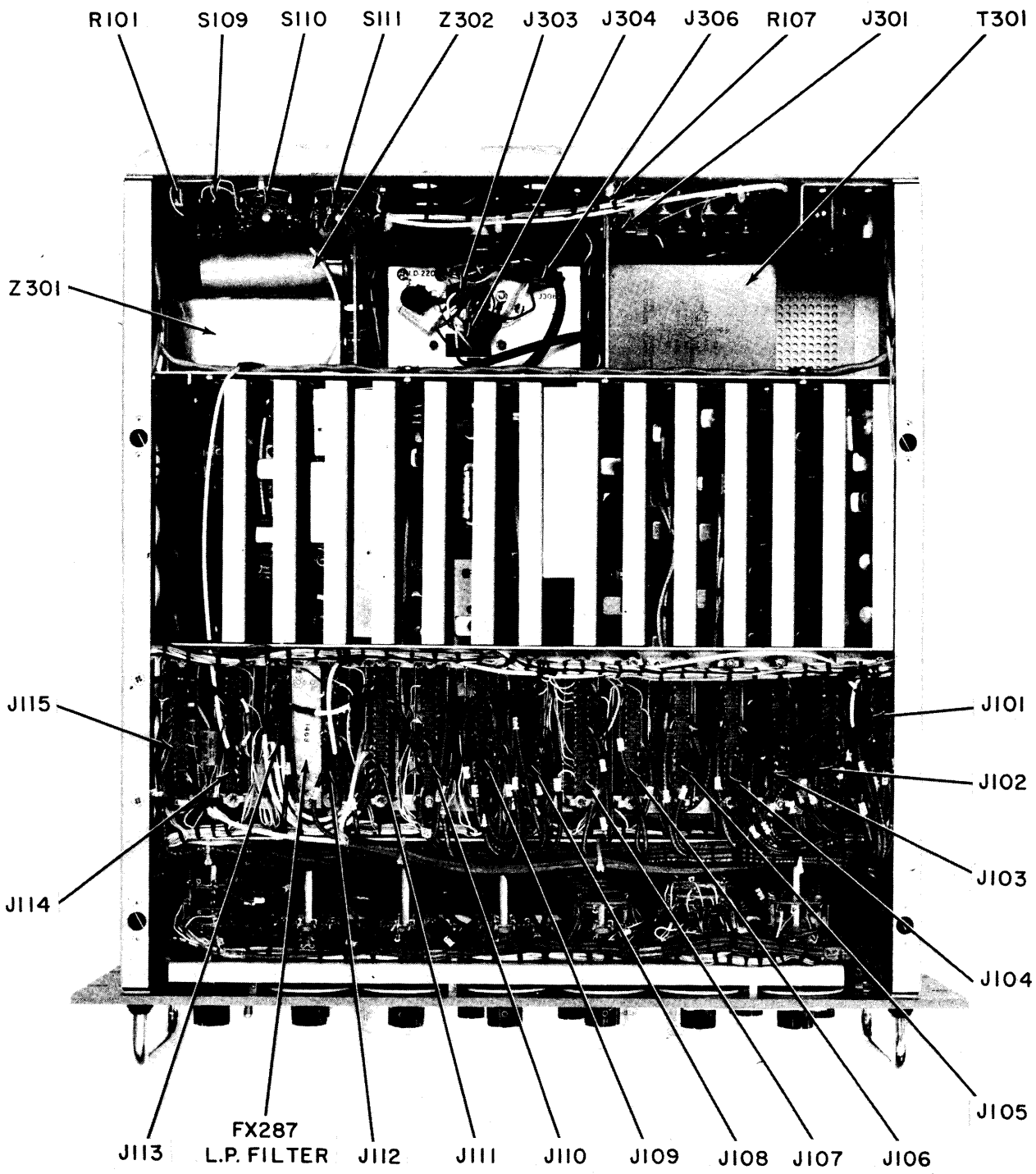

Figure 5-2. Bottom View, Location of Major Components

5-3. ALIGNMENT

a. GENERAL. The following paragraphs present alignment procedures required to maintain the Exciter in a satisfactory operating condition.

b. TEST EQUIPMENT REQUIRED. Table 5-3 presents a listing of test equipment required for complete alignment of the Exciter.

TABLE 5-3. TEST EQUIPMENT REQUIRED

Equipment	Manufacturer
Signal Generator	Hewlett-Packard Model 606A, or equivalent
Oscilloscope	Tektronix, Model 541A, or equivalent
Spectrum Analyzer	Lavoie Laboratories, Inc. Model LA-40A, or equivalent
Audio Generator	Hewlett-Packard Model 200 CD, or equivalent
VTVM	Ballantine Model 314, or equivalent
Frequency Counter	Hewlett-Packard Model 5244L, or equivalent
Attenuator	Telonic Model D-550, or equivalent
Millivolt Meter	Millivac Model MV-28B, or equivalent
VTVM	Hewlett-Packard Model 410B, or equivalent

c. POWER SUPPLY BOARDS Z303 AND Z304 (see figure 5-3). Align the power supply boards as follows:

- (1) Plug in ac line cord, STANDBY indicator shall illuminate amber.
- (2) Position ON/STANDBY switch to ON. POWER indicator shall illuminate red and STANDBY indicator shall extinguish.

NOTE

Allow approximately 15 minutes for equipment to warm up.

- (3) On board Z303, adjust potentiometers R3 and R12 fully clockwise.
- (4) Connect voltmeter between J304-G (ground) and J304-A. Voltmeter shall indicate approximately +40 vdc.

(5) On board Z303, connect voltmeter to J303-E. Voltmeter shall indicate approximately +20 vdc.

(6) Connect voltmeter to J303-A. Voltmeter shall indicate approximately +40 vdc.

(7) Connect voltmeter between J303-F and ground. Adjust potentiometer R8 to obtain an indication of 12.0 vdc on voltmeter.

(8) Remove voltmeter from J303-F and connect oscilloscope. Maximum ac ripple shall not exceed 5 mv.

(9) Adjust potentiometer R3 until voltage level starts to drop, then back up slightly to obtain full voltage.

(10) Connect voltmeter between J303-4 and ground. Adjust potentiometer R18 to obtain an indication of 24.0 vdc on voltmeter.

(11) Remove voltmeter from J303-4 and connect oscilloscope. Maximum ac ripple shall not exceed 2 mv.

(12) Adjust potentiometer R12 until voltage level starts to drop, then back off to obtain full voltage.

(13) Connect voltmeter between J301-E and ground. Voltmeter shall indicate +30 vdc \pm 1 vdc.

(14) Position ON/STANDBY switch to STANDBY.

(15) Position METER switch to Q1.

(16) Connect ammeter to J115-9 as shown in figure 5-3.

(17) Adjust potentiometer R106 (located at rear of METER switch) for an equal indication on MONITOR meter and voltmeter.

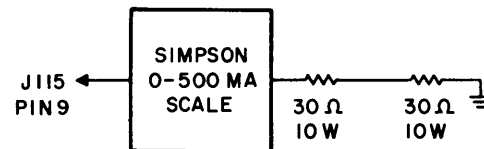

Figure 5-3. Power Supply Board Test Setup

d. SPECTRUM GENERATOR Z101. (See figure 7-2.) Align the spectrum generator board as follows:

NOTE

Place cards Z103, Z105 and Z106 into unit for 1 MHz load.

- (1) For 1 MHz set STD INT/EXT switch on rear panel to INT position. Place scope between J101-A and ground and adjust transformer T1 for maximum output.
- (2) Place scope between J101-3 and ground and adjust potentiometer R60 for 0.6 volt peak-to-peak output.
- (3) Measure level at collector of transistor Q3 with scope (1 MHz spectrum of 1.5 volts peak-to-peak).

- (4) Measure level at J101-D (100 kHz spectrum of 1.0 volt peak-to-peak).
- (5) Insert Z113 and set 10 MHz switch on front panel to between 21 and 30 MHz. (Set all other switches on front panel to 0 position.) Place scope between TP3 and ground. Adjust transformer T2 and capacitor C12 for maximum output at 12 MHz.
- (6) Place scope to pin 8 and ground lead to pin J. Adjust transformer T3 for maximum output at 12 MHz. (Approximately 0.4 volt peak-to-peak.) Switch position 11 - 20 MHz.
- (7) Place scope between TP6 and ground. Adjust capacitor C50 and transformer T8 for maximum signal at 13 MHz.
- (8) Place scope between J101-P and ground lead to pin R. Adjust transformer T9 for maximum output at 13 MHz (approximately 0.4 volt peak-to-peak).
- (9) Place scope between TP9 and ground. Adjust capacitor C73 and transformer T10 for maximum output at 8 MHz in all positions of the 1 and 10 MHz switches.
- (10) Place scope between J101-S and ground lead to pin 15. Adjust transformer T11 for maximum output at 8 MHz. Output shall be approximately 1.5 volts peak-to-peak.
- (11) Insert Z110 and set 10 MHz switch on front panel to a position between 0 and 10. Place scope between TP5 and ground. Adjust capacitor C36 and transformer T6 for maximum output.
- (12) Place scope between pin 13 and ground lead to pin 12. Adjust transformer T7 for maximum output at 14 MHz. Output level should be approximately 0.75 volt peak-to-peak.
- (13) Insert Z112 into Exciter. Place Millivac MV-28B meter between pin 11 and ground lead to pin 10. Set analyzer to read 40 MHz. Adjust capacitors C86 and C89 for maximum output at 40 MHz. Output should be approximately 70 mv rms.

e. COMB FILTER Z102. (See figure 7-3.) Before performing the following alignment procedure, set the 100 Hz, 1 kHz, 10 kHz and 100 kHz frequency selector switches to blank position; insert comb filter Z103 into Exciter.

- (1) Connect oscilloscope between TP11 and ground. Adjust tuned transformer T11 and variable capacitor C54 for maximum output at 0.8 MHz.
- (2) Connect oscilloscope between J102-S and J102-15 (ground). Adjust transformer T12 for maximum output; adjust potentiometer R42 for 0.7 volt peak-to-peak output at 0.8 MHz.
- (3) Connect oscilloscope between TP9 and ground. Adjust tuned transformer T9 and variable capacitor C43 for maximum output at 1.0 MHz.
- (4) Connect oscilloscope between J102-J and ground. Adjust transformer T10 for maximum output; adjust potentiometer R35 for 0.7 volt peak-to-peak at 1.0 MHz.
- (5) Connect oscilloscope between TP7 and ground. Adjust tuned transformer T7 and variable capacitor C32 for maximum output at 1.2 MHz.
- (6) Connect oscilloscope between J102-P and ground. Adjust transformer T8 for maximum

output; adjust potentiometer R28 for 0.7 volt peak-to-peak at 1.2 MHz.

- (7) Connect oscilloscope between TP5 and ground. Adjust tuned transformer T5 and variable capacitor C22 for maximum output at 1.4 MHz.
- (8) Connect oscilloscope between J102-F and ground. Adjust transformer T6 for maximum output; adjust potentiometer R21 for 0.7 volt peak-to-peak at 1.4 MHz.
- (9) Connect oscilloscope between TP4 and ground. Adjust tuned transformer T3 and variable capacitor C11 for maximum output at 1.6 MHz.
- (10) Connect oscilloscope between J102-L and ground. Adjust transformer T4 for maximum output; adjust potentiometer R14 for 0.7 volt peak-to-peak at 1.6 MHz.
- (11) Connect oscilloscope between TP1 and ground. Adjust tuned transformer T2 and variable capacitor C10 for maximum output at 1.8 MHz.
- (12) Connect oscilloscope between J102-4 and ground. Adjust transformer T1 for maximum output; adjust potentiometer R3 for 0.7 volt peak-to-peak at 1.8 MHz.

f. COMB FILTER Z103. (See figure 7-4.) Align comb filter Z103 following the alignment procedure given for comb filter Z102 (paragraph e.) and substitute frequencies of 0.9, 1.1, 1.3, 1.5, 1.7 and 1.9 MHz for 0.8, 1.0, 1.2, 1.4, 1.6 and 1.8 MHz respectively.

g. SINGLE MIXER-DIVIDER Z104. (See figure 7-5.) Align single mixer-divider Z104 as follows:

- (1) Connect oscilloscope between cathode of diode CR1 and ground. Adjust transformer T1 for maximum output at 8 MHz.
- (2) Short J104-B to ground and connect oscilloscope between TP1 and ground. Adjust potentiometer R7 for minimum output at 8 MHz. Level across diodes CR1 and CR2 shall be approximately 0.5 volt peak-to-peak. Remove spectrum generator printed circuit card Z101 from connector J101.
- (4) Connect oscilloscope between TP5 and ground.
- (5) Connect signal generator between TP1 and ground, and terminate signal generator output with a 47-ohm resistor. Adjust signal generator input for a 9.05 MHz, 10 mv rms, signal.
- (6) Adjust transformers T2 through T6 for maximum output at 9 MHz. Output shall be approximately 0.5 volt peak-to-peak.
- (7) Connect oscilloscope between TP6 and ground. Adjust potentiometer R23 for minimum output at 9 MHz. Remove short from J104-B.
- (8) Connect signal generator input to TP6 through a 220-ohm series resistor. Adjust generator input for a 10.4 MHz signal at 10 mv rms.
 - (a) Connect oscilloscope between TP6 and ground. Short TP7 to ground, and adjust transformer T7 for maximum output (10-10.9 MHz).
 - (b) Remove short from TP7, and adjust transformer T8 for minimum output measured at TP6.

(c) Connect oscilloscope between TP8 and ground. Short TP9 to ground and adjust transformer T9 for maximum output (10 - 10.9 MHz).

(d) Remove short from TP9, and adjust transformer T10 for minimum output measured at TP8.

(e) Connect oscilloscope between TP10 and ground. Adjust transformer T11 for maximum output (10-10.9 MHz). With a signal generator input of 10 mv rms, the output shall be 0.4 volt peak-to-peak ± 6 db for the range of 10 MHz to 11 MHz.

(9) Disconnect signal generator, and reinsert spectrum generator card into connector J101.

(10) Connect oscilloscope between J104-15 and J104-R (ground).

(11) Rotate Exciter 100 Hz frequency selector switch from position zero to position 9. Output shall be 0.6 volt peak-to-peak minimum with frequency variation of 1.0 MHz to 1.09 MHz.

h. DUAL MIXER-DIVIDER Z105. (See figure 7-6.) Align dual mixer-divider Z105 as follows:

(1) Connect oscilloscope between cathode of diode CR1 and ground. Adjust 100 Hz switch to blank position. Adjust transformer T1 for maximum output at 8 MHz. Connect oscilloscope to TP1. Adjust potentiometer R9 for minimum output. Output at cathode of CR1 shall be 0.5 volt peak-to-peak minimum.

(2) Connect oscilloscope probe on cathode side of CR3 and ground lead to ground. Adjust 1 kHz switch to blank position. Adjust 100 Hz switch to position 5. Adjust transformers T2, T3, T4, T5 and T6 for maximum output at 9 - 9.09 MHz.

(3) Connect oscilloscope probe on TP5, and adjust potentiometer R23 for minimum output. Output at cathode of CR3 shall be 0.5 volt peak-to-peak minimum in 100 Hz switch positions 0 through 9.

(4) Rotate 100 Hz selector switch to blank position. Connect signal generator through a 220-ohm resistor to TP5. Adjust signal generator output for 10.4 MHz at 10 mv rms and terminate generator line with 47-ohm resistor.

(a) Connect oscilloscope probe to TP5 with ground lead to ground. Short TP6 to ground, and adjust transformer T7 for maximum output at 10-10.99 MHz. Remove short from TP6, and adjust transformer T8 for minimum output.

(b) Connect oscilloscope probe to TP7, with ground lead grounded near this point. Short TP8 to ground. Adjust transformer T9 for maximum output. Remove short from TP8 and adjust transformer T10 for minimum output.

(c) Connect oscilloscope probe between TP9 and ground. Adjust transformer T11 for maximum indication. With signal generator input of 10 mv rms, the output shall be 0.2 volt peak-to-peak minimum for the range of 10 MHz to 11 MHz.

(5) Disconnect signal generator. Place oscilloscope probe at the junction of choke L4 and resistor R46. With 100 Hz switch in position 5, rotate the 1 kHz switch from position 0 to position 9. The output shall be 0.6 volt peak-to-peak at 1 - 1.099 MHz.

(6) Rotate the 1 kHz switch to blank position. Place the oscilloscope probe between cathode end of diode CR6 and ground. Adjust T12 for maximum output at 8 MHz. Connect oscilloscope probe to TP10.

Adjust potentiometer R54 for minimum output. Output at cathode of CR6 shall be 0.5 volt peak-to-peak minimum.

(7) Connect oscilloscope probe between cathode side of diode CR8 and ground. Rotate the 1 kHz switch to position 5. Adjust transformers T13, T14, T15, T16 and T17 for maximum output at 9 - 9.099 MHz. With the 1 kHz switch in position 5, place scope probe between TP14 and ground. Adjust R69 for minimum indication. Output at cathode of CR8 should be 0.5 volt peak-to-peak minimum, with the 1 kHz switch in positions 0 through 9.

(8) Rotate the 1 kHz switch to blank position. Connect signal generator through 220-ohm resistor to TP14. Connect ground lead to ground. Terminate signal generator lead with 47-ohm resistor.

(a) Connect oscilloscope probe between TP14 and ground. Adjust signal generator for 10.4 MHz. Short TP15 to ground. Adjust transformer T18 for maximum output at 10 - 10.999 MHz. Remove short from TP15 and adjust transformer T19 for minimum output.

(b) Connect oscilloscope probe between TP16 and ground. Short TP17 to ground. Adjust transformer T20 for maximum output. Remove short from TP17. Adjust transformer T21 for minimum output.

(c) Connect oscilloscope probe between TP18 and ground. Adjust transformer T22 for maximum output. With a generator input of 10 mv rms the output shall be 0.4 volt peak-to-peak ± 6 db for the range of 10 MHz to 11 MHz.

(9) Disconnect signal generator and rotate 1 kHz switch to position 5. Place oscilloscope between J105-15 and J105-R (ground). Rotate 10 kHz switch from position 0 through position 9. Output shall be 0.6 volt peak-to-peak over a frequency variation from 1.0 to 1.0999 MHz.

i. FINAL MIXER Z106. (See figure 7-7.) Align final mixer Z106 as follows:

(1) Connect oscilloscope between cathode of diode CR2 and ground. Rotate 10 kHz frequency selector switch to blank position. Rotate 100 kHz switch to position 5. Adjust transformer T1 for maximum output at 8 MHz.

(2) Connect oscilloscope between TP1 and ground. Adjust potentiometer R7 for minimum output.

(3) Place short between J106-H and J106-E. Output at cathode of CR2 should be 0.5 volt peak-to-peak minimum.

(4) Rotate 1 kHz and 10 kHz selector switches to position 5. Place scope probe between cathode CR3 and ground. Adjust transformers T2 through T6 and T13 for maximum output at 9 - 9.0999 MHz.

(5) Connect oscilloscope between junction diodes CR4/CR3 and ground. Adjust potentiometer R18 for minimum output. Output at cathode of diode CR3 shall be 0.5 volt peak-to-peak minimum.

(6) Rotate 10 kHz frequency selector switch to blank position. Connect signal generator to TP5 through a 220-ohm resistor. Connect ground lead to ground.

(7) Adjust signal generator for 10.4 MHz. Rotate 100 kHz switch to position 4.

(8) Connect oscilloscope between TP5 and ground. Short TP7 to ground. Adjust transformer T7 for maximum output.

(9) Remove short from TP7 and adjust transformer T8 for minimum output.

(10) Connect oscilloscope between TP8 and ground. Short TP9 to ground.

(11) Adjust transformer T9 for maximum output.

(12) Remove short from TP9 and adjust transformer T10 for minimum output.

(13) Remove translator Z112 from Exciter. Connect a 47-ohm resistor between J106-12 and J106-13.

(14) Connect oscilloscope between TP10 and ground. Short secondary of transformer T12.

(15) Rotate 100 kHz frequency selector switch to position 5. Adjust signal generator for a frequency of 10.75 MHz.

(16) Adjust transformer T11 for maximum output. Remove short from transformer T12 and adjust transformer T12 for minimum output.

(17) Rotate 100 kHz frequency selector switch to position 4. Adjust signal generator frequency for 10.1 MHz. Short secondary of transformer T12.

(18) Adjust variable capacitor C36 for maximum output. Remove short from transformer T12 and adjust variable capacitor C48 for minimum output.

(19) Connect oscilloscope across the 47-ohm resistor (step 13). Set signal generator for 10.5 MHz, 100 mv output.

(20) Rotate 100 kHz frequency selector switch to position 4. Output shall be 0.2 volt peak-to-peak with generator frequency of 10 MHz to 10.5 MHz.

(21) Rotate 100 kHz frequency selector switch to position 5. Output shall be at least 0.2 volt peak-to-peak with a frequency input of 10.5 MHz to 11 MHz.

(22) Remove signal generator input and rotate 10 kHz frequency selector switch to position 5. Remove short from J106-H and J106-E.

(23) Rotate 100 kHz frequency selector switch from zero position to position 9. Output shall be 0.2 volt peak-to-peak minimum.

(24) Remove 47-ohm resistor from J106-12 and J106-13. Replace translator Z112.

j. CARRIER GENERATOR Z109. (See figure 7-11.) Align carrier generator Z109 as follows:

(1) Adjust potentiometer R27 fully ccw; set EXCITER switch ON and set MODE switch to AM position. Connect oscilloscope to TP1. Voltage shall be 10.0 volts peak-to-peak at 1.0 MHz.

(2) Connect oscilloscope to TP3 and adjust transformer T1 for maximum level at 250 kHz (approximately 900 mv peak-to-peak).

(3) Connect oscilloscope to TP4 and adjust transformer T2 for maximum level. (approximately 1.4 volts peak-to-peak.)

(4) Adjust potentiometer R51 fully clockwise. Connect oscilloscope to TP6 and adjust transformer T3 for maximum level of approximately .66 volt peak-to-peak at 2.75 MHz (figure 5-4).

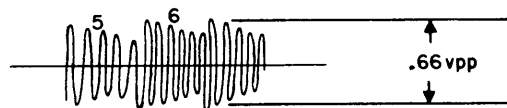

Figure 5-4. Carrier Generator Alignment Waveform (11 cycles/envelope pattern)

(5) Connect oscilloscope to TP7 and adjust transformer T4 for maximum level. (approximately 0.5 volt peak-to-peak). Adjust potentiometer R47 for 70 mv peak-to-peak. (2.75 MHz)

(6) Set MODE switch in AM position and remove sideband generator Z107. Connect oscilloscope to TP8 and adjust transformer T5 for maximum level (approximately 1.0 volt peak-to-peak). Replace sideband generator Z107.

k. SIDEBAND GENERATOR Z107. (See figure 7-12.) Align sideband generator Z107 as follows:

NOTE

Carrier generator Z109 must be aligned and placed in the Exciter. Remove frequency shift generator Z108 and adjust potentiometers R34 and R60 fully clockwise.

(1) Connect audio generator with one side grounded to USB terminals on the rear of the Exciter.

(2) Set audio generator for 1 kHz with output level set to 69 mv. (-20 dbm).

(3) Set MODE switch and METER switch on front panel to USB positions.

(4) Set USB MIKE/LINE control for 2/5 of full scale reading on front panel MONITOR meter.

(5) Connect VTVM (Ballantine model 314) to TP4. Level shall be approximately 0.016 volt rms.

(6) Connect oscilloscope to TP5 and adjust transformer T1 for maximum level. Adjust USB MIKE/LINE control for full scale reading on meter.

(7) Adjust potentiometer R28 and variable capacitor C52 until waveform, as shown in figure 5-5, is symmetrical and crossover is sharp and clear as viewed on oscilloscope.



Figure 5-5. Sideband Generator Alignment Waveform

(8) Return USB MIKE/LINE control to 2/5 full scale reading on MONITOR meter. Adjust potentiometer R34 for 200 mv peak-to-peak at collector of Q7. Check output of sideband filter for approximately 75 mv peak-to-peak.

(9) Repeat steps (1) through (8) for LSB using:

- (a) TP11 for step (5).
- (b) TP8 and T2 for step (6).
- (c) R54 and C53 for step (7).
- (d) R60 and Q12 for step (8).

(10) Remove audio generator input to Exciter and connect to MIKE input or to J107-E and ground.

(11) Set audio generator for 1 kHz with output level of 1.0 mv as measured with Ballantine 314, and short capacitor C49.

(12) Connect Ballantine 314 to TP3 and adjust potentiometer R9 for a level of 40 mv rms.

1. FREQUENCY SHIFT GENERATOR Z108. (See figure 7-13.) Align frequency shift generator Z108 as follows:

NOTE

Do not attempt the FSK or FAX adjustments without a one-hour warm-up period for the 3 MHz oven.

(1) Set MODE switch to ISB position, and remove frequency shift generator Z108 from Exciter. Adjust potentiometer R58 fully counterclockwise and adjust CARRIER control fully clockwise.

(2) Set EXCITER switch to ON position and measure 2.75 MHz input at J108-C (approximately 70 mv peak-to-peak). Measure 250 kHz input at J108-2 (approximately 70 mv peak-to-peak). Insert Z108 into Exciter.

(3) Place scope at TP4 and tune transformer T1 for maximum level.

(4) Place scope at J108-7 and tune transformers T1 and T2 for maximum level. (approximately 0.4 volt peak-to-peak)

(5) Connect frequency counter to vertical output terminals of scope.

(6) Place MODE switch in FSK position. On rear panel set:

- (a) R101 to mid-range.
- (b) Frequency SHIFT switch to ± 425 (maximum) shift position.
- (c) Sense switch to + (up) position.

(7) Adjust potentiometer R56 for maximum level indication on oscilloscope. Locations of adjustment potentiometers are shown in figure 5-6.

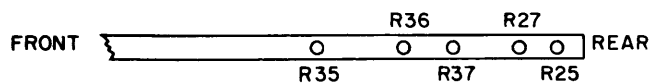

Figure 5-6. Frequency Shift Generator Adjustment Locations

(8) Set potentiometers R35 and R36 fully counterclockwise.

(9) Adjust potentiometer R37 for 3,000,000 Hz indication on frequency counter.

(10) Adjust potentiometer R36 for 2,999,575 Hz indication on frequency counter.

(11) Set SENSE switch to (-) down position, and adjust potentiometer R35 for 3,000,425 Hz indication on frequency counter.

(12) Repeat steps (10) and (11) until specified frequencies are within 5 Hz.

(13) Set frequency shift switch to ± 212 position (rear panel) and set SENSE switch to (+) up position. Counter shall indicate 2,999,788 ± 15 Hz.

(14) Set SENSE switch to (-) down position. Counter shall indicate 3,000,212 ± 15 Hz.

(15) Repeat steps (13) and (14) for ± 106 shift position. Specified frequencies (+2,999,894 - 3,000,106) shall be within ± 10 Hz.

(16) Repeat steps (13) and (14) for ± 53 shift position. Specified frequencies (+2,999,947 - 3,000,053) shall be within ± 7 Hz.

(17) Set MODE switch to FAX position. Set potentiometer R25 fully clockwise.

(18) Connect 0-10V power supply to FAX terminals on Exciter rear panel and set for 1.0 volt input.

(19) Adjust potentiometer R27 for 2,999,600 ± 5 Hz indication on counter.

(20) Reset input to 10.0 volts and adjust potentiometer R25 for 3,000,400 ± 5 Hz indication on counter.

(21) Repeat steps (18) through (20).

(22) Check for linearity by varying input from 1.0 to 10.0 volts. Counter shall change 89 ± 5 Hz for every 1.0 volt change from 1.0 volt to 10.0 volts as shown in table 5-4.

TABLE 5-4. FAX VOLTAGE VS. FREQUENCY LINEARITY CHECK

Volts	Frequency	Volts	Frequency
1	600 ± 5 Hz	6	1045 ± 5 Hz
2	689 ± 5 Hz	7	1134 ± 5 Hz
3	778 ± 5 Hz	8	1223 ± 5 Hz
4	867 ± 5 Hz	9	1312 ± 5 Hz
5	956 ± 5 Hz	10	1400 ± 5 Hz

m. STEP GENERATOR Z110. (See figure 7-8.) Align step generator Z110 as follows:

(1) Remove comb filters Z102 and Z103 from Exciter. Set frequency selector switches to 03.0000 MHz.

(2) Connect oscilloscope between collector of transistor Q1 and ground. Adjust potentiometer R1 for maximum level.

(3) Connect oscilloscope at junction of diode CR1 and transformer T1. Adjust transformer T1 for maximum level.

(4) Connect oscilloscope between collector of transistor Q1. Adjust potentiometer R1 for a level of 2 volts peak-to-peak.

(5) Connect oscilloscope between junction of diodes CR1/CR2 and ground. Adjust potentiometer R7 for minimum level.

(6) Connect test equipment as shown in figure 5-7.

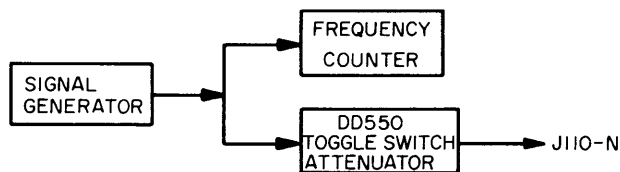

Figure 5-7. Step Generator Z110, Test Setup

(7) Set signal generator frequency to 1.05 MHz and output level to 100 mv peak-to-peak.

(8) Connect oscilloscope to J110-R and adjust potentiometer R28 for a level of 0.4 volt peak-to-peak.

(9) Short secondary transformer T3.

(10) Connect millivac model MV-28B millivoltmeter at junction of resistor R8 and capacitor C8.

(11) Adjust transformer T2 for maximum level indication on millivoltmeter.

(12) Remove short from transformer T3. Adjust T3 for dip or minimum indication on millivoltmeter.

(13) Repeat steps 10 through 12, using transformer T5 and collector of Q2 for step 10; transformer T4 for step 11; and transformer T5 for step 12.

(14) Repeat steps 10 through 12, using transformer T7 and collector of Q3 for step 10; transformer T6 for step 11; and transformer T7 for step 12.

(15) Connect oscilloscope between J110-5 and ground. Adjust transformer T8 for maximum level indication.

(16) Vary frequency of signal generator from 0.8 MHz to 1.2 MHz. Output shall be approximately 2 volts peak-to-peak minimum at frequency of 13.2 MHz to 12.8 MHz, correspondingly.

(17) Adjust signal generator to 1.55 MHz. Set frequency selector switches to 07.0000 MHz.

(18) Repeat steps 10 through 12, using transformer T11 and junction of resistor R9 and capacitor C9 for step 10; transformer T10 for step 11; and transformer T11 for step 12.

(19) Repeat steps 10 through 12, using transformer T13 and collector of transistor Q6 for step 10; transformer T12 for step 11; and transformer T13 for step 12.

(20) Repeat steps 10 through 12, using transformer T15 and collector of transistor Q7 for step 10; transformer T14 for step 11; and transformer T15 for step 12.

(21) Repeat steps 15 and 16, using transformer T16 for step 15. Use 1.3 MHz to 1.7 MHz and 12.7 MHz to 11.3 MHz for step 16.

(22) Remove generator from J110-N. Adjust frequency selector switches on front panel to 13.0000 MHz.

(23) Repeat steps 2 through 6, using resistor R61 and collector of Q9 for step 2; diode CR3 and transformer T17 for step 3; resistor R61 and collector of transistor Q9 for step 4; and diodes CR3/CR4 and resistor R67 for step 5.

(24) Repeat steps 10 through 12, using transformer T19 and junction of resistor R68 and capacitor C80 for step 10; transformer T18 for step 11; and transformer T19 for step 12.

(25) Repeat steps 10 through 12, using transformer T21 and collector of transistor Q10 for step 10; transformer T20 for step 11; and transformer T21 for step 12.

(26) Repeat steps 10 through 12, using transformer T23 and collector of transistor Q11 for step 10; transformer T22 for step 11; and transformer T23 for step 12.

(27) Repeat steps 15 and 16, using pin J110-4 and transformer T24 for step 15; and 0.8 MHz to 1.2 MHz and 12.2 MHz to 11.8 MHz for step 16.

(28) Repeat step 17 using 17.0000 MHz.

(29) Repeat steps 10 through 12, using transformer T26 and junction of R69/C81 for step 10; transformer T25 for step 11; and transformer T26 for step 12.

(30) Repeat steps 10 through 12, using transformer T28 and collector Q13 for step 10; transformer T27 for step 11; and transformer T28 for step 12.

(31) Repeat steps 10 through 12, using transformer T30 and collector of transistor Q14 for step 10; transformer T29 for step 11; and transformer T30 for step 12.

(32) Repeat steps 15 and 16, using J110-4 and transformer T31 for step 15; and 1.3 MHz to 1.7 MHz and 11.7 MHz to 11.3 MHz for step 16.

(33) Replace step generator Z110 in Exciter.

n. STEP GENERATORS Z111 AND Z113. (See figures 7-9 and 7-10.) Align step generators Z111 and Z113 as follows:

(1) Remove comb filters Z102 and Z103 from Exciter and set frequency selector switches on front panel to 28.0000 MHz.

(2) On Z113, connect oscilloscope at collector of transistor Q14. Adjust potentiometer R78 for maximum level.

(3) Connect oscilloscope at junction of transformer T11 and diode CR1. Adjust transformer T11 for maximum level.

(4) Connect oscilloscope at junction of capacitor C104 and resistor R88. Adjust variable capacitor C101 and resistor R84 alternately until minimum level is obtained.

(5) Connect oscilloscope at collector of transistor Q14. Adjust potentiometer R78 for 2 volts peak to peak.

(6) Connect test equipment as shown in figure 5-7. Set signal generator frequency to 1.6 MHz. Set output level to 100 mv peak-to-peak.

(7) Short secondary of transformer T13. Place Millivac model MV-28B millivolt meter at junction of resistor R88 and capacitor C104.

(8) Adjust transformer T12 for maximum level indication on meter.

(9) Remove short and adjust transformer T13 for dip or minimum indication on meter.

(10) Repeat steps 7 through 9, using transformer T15 and Q15 collector for step 7; transformer T14 for step 8; and transformer T15 for step 9.

(11) Repeat steps 7 through 9, using transformer T17 and Q16 collector for step 7; transformer T16 for step 8; and transformer T17 for step 9.

(12) Place scope at J113-N and adjust transformer T18 for maximum level indication.

(13) Vary frequency of signal generator for 1.4 MHz to 1.8 MHz. Output level on oscilloscope shall be approximately 0.1 volt peak-to-peak minimum at frequency of 10.6 MHz to 10.2 MHz, correspondingly.

(14) Adjust signal generator to 1.075 MHz with output level set at 0.4 volt peak-to-peak and change frequency selector switches on front panel to 23.0000 MHz.

(15) Repeat steps 7 through 9, using transformer T20 and junction of resistor R87 and capacitor C103 for step 7; transformer T19 for step 8; and transformer T20 for step 9.

(16) Repeat steps 7 through 9, using transformer T22 and Q18 collector for step 7; transformer T21 for step 8; and transformer T22 for step 9.

(17) Repeat steps 7 through 9, using transformer T24 and Q19 collector for step 7; transformer T23 for step 8; and transformer T24 for step 9.

(18) Repeat steps 12 and 13, using transformer T25 for step 12; and 0.8 MHz to 1.3 MHz and 11.2 MHz to 10.7 MHz for step 13.

(19) Replace comb filters Z102 and Z103 into unit.

(20) Set frequency selector switches on front panel to 25,000 MHz. Place millivolt meter on J111-1 of step generator Z111.

(21) Adjust C3, C9 and C19 for maximum level on meter.

(22) Vary frequency selector switches on front panel from 21.0000 MHz to 31.0000 MHz in 1 MHz steps. Minimum level indication on meter should be 0.04 volt rms. If necessary, stagger tune capacitors in step 21.

(23) Repeat steps 20 through 22, using 15.000 MHz and J111-2 for step 20; C25, C30 and C41 for step 21; and 11.0000 MHz to 20.0000 for step 22.

(24) Repeat steps 20 through 22, using 05.0000 MHz and J111-3 for step 20; C45, C49 and C62 for step 21; and 01.0000 MHz to 10.0000 MHz for step 22.

(25) On board Z113, repeat steps 20, 21, and 22 using 25.0000 MHz and J113-1 for step 20; C10, C16, C22 and C28 for step 21; and 0.4 volt rms for step 22.

(26) Repeat steps 20, 21, and 22 using 15.0000 MHz and J113-1 for step 20; C29, C40, C51 and C56 for step 21; and 0.4 volt rms for step 22.

(27) Repeat steps 20, 21 and 22 using 0.50000 MHz and J113-1 for step 20; C68, C75, C81 and C87 for step 21; and 0.4 volt rms for step 22.

o. **TRANSLATOR Z112.** (See figure 7-14.) Align translator Z112 as follows:

(1) Remove rf output Z115 from Exciter. Set all frequency selector switches to blank position. Remove step generator Z113 from Exciter, and set EXCITER switch to PTT position.

(2) Connect test equipment as shown in figure 5-8. Connect signal generator between junction

of resistors R73 and R75 and ground. Position potentiometers R51, R97 and R109 to mid-range.

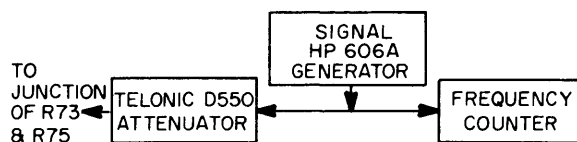

Figure 5-8. Translator Z112, Test Setup

(3) With full attenuation on the toggle switch attenuator, adjust signal generator for 1 volt output at frequency of 13.3000 MHz. Set 100 kHz switch on front panel to position 3.

(4) Short secondary of transformer T15. Connect Millivac Model MV-28B across primary of transformer T13, observing proper ground. Set meter to 0.01 volt range.

(5) Remove attenuation from telonic attenuator until midscale reading is observed on meter. (Maintain reading on 0.01 scale of meter, using attenuator for the following steps.)

(6) Adjust transformer T13 for peak indication on meter.

(7) Remove short from transformer T15. Adjust T15 for dip on meter.

(8) Short secondary of transformer T17 and connect Millivac meter across secondary of transformer T16, observing proper ground.

(9) Change attenuation of telonic attenuator for mid-scale reading on meter. Adjust transformer T16 for peak indication on meter.

(10) Remove short from transformer T17. Adjust T17 for dip on meter.

(11) Connect meter to TP7. Adjust transformer T17 for maximum indication on meter.

(12) Repeat steps 3 through 11, using 13.80000 MHz and position 8 for step 3; T20 and T19, respectively, for step 4; T19 for step 6; T20 for step 7; T22 and T21, respectively, for step 8; T21 for step 9; T22 for step 10; and TP9 for step 11.

(13) Remove signal generator and set frequency selector switches on front panel to 05.0000 MHz. Set MODE switch to AM and EXCITER switch to ON.

(14) Using oscilloscope, check for 10.5 MHz signal at level of 0.2 volt peak-to-peak minimum on J112-H, and for a 3 MHz signal of approximately 90 mv peak-to-peak on J112-D.

(15) Adjust potentiometer R71 to mid-position. Tune transformer T12 for maximum indication on meter. (Meter connected to TP7 or TP9.)

(16) Remove frequency shift generator Z108 from Exciter. Connect Millivac meter to junction of resistor R73 and R75, observing proper ground.

(17) Adjust potentiometer R71 for minimum indication on meter. Return all frequency selector switches on front panel to blank positions.

(18) Using Millivac meter, check for 40 MHz signal at approximately 50 mv rms level on J112-B.

(19) Connect meter to transformer T3

secondary, observing proper ground. Tune transformers T1, T2 and T3 for maximum indication.

(20) Connect spectrum analyzer to TP7. Adjust potentiometer R36 to one extreme position. Tune capacitors C20, C26 and C31 for maximum 120 MHz indication on analyzer.

(21) Connect spectrum analyzer to TP3. Adjust potentiometer R36 for minimum 120 MHz indication. Reinsert Z108 into Exciter. Adjust frequency selector switches on front panel to 05.5000 MHz.

(22) Adjust variable capacitors C37 and C42 for maximum 133.5 MHz indication on spectrum analyzer.

(23) Connect spectrum analyzer to TP4. Adjust variable capacitors C48, C42 and C37 for maximum 133.5 MHz indication. Connect analyzer to TP5 and adjust variable capacitors C54, C48, C42 and C37 for maximum 133.5 MHz indication. Connect spectrum analyzer to TP6 and adjust variable capacitors C60, C54, C48, C42 and C37 for maximum 133.5 MHz indication.

(24) Replace step generator Z113. Connect oscilloscope to J112-R. Output level shall be 0.2 volt minimum at a frequency corresponding to the front panel frequency selector switches.

(25) Connect the 0 - 10 volt power supply between J112-10(+) and ground (-). Increase voltage from 0 to 10 volts. Output level on oscilloscope should drop to zero as the voltage increases from 6.5 to 8.5 volts.

p. RF OUTPUT Z115. (See figure 7-15.) Before aligning rf output Z115, remove card from Exciter and adjust potentiometers R1, R2 and R4 for maximum resistance. Check power supply for correct operating voltages. Reinstall rf output Z115; set RF OUTPUT control fully counterclockwise; set MODE switch to AM; and set EXCITER switch to ON.

- (1) Set METER switch to Q1 position.
- (2) Adjust potentiometer R4 until MONITOR meter is located in center of green region marked Q1.
- (3) Set METER switch to Q2 position.
- (4) Adjust potentiometer R2 until MONITOR meter is located in center of green region marked Q2.
- (5) Set METER switch to Q3 position.
- (6) Adjust potentiometer R1 until MONITOR meter is located in center of green region marked Q3.
- (7) Connect a 50-ohm load to RF OUT jack located on rear panel of Exciter. Connect VTVM across the load. Set frequency selector switches to 29.9999 MHz. Turn ALDC control on rear of unit fully counterclockwise and short J115-S to J114-B.
- (8) Connect oscilloscope to J115-B.
- (9) Adjust front panel RF CONTROL until oscilloscope indicates 220 mv peak-to-peak. VTVM shall indicate 3.55 volts rms.
- (10) Remove short (step 7) and insert Z114 and J114. Output shall not vary more than 0.2 volt.
- (11) Using Simpson 260 meter, measure dc voltage at J115-12; voltage shall vary from zero to -12 vdc with ALDC adjustment on rear panel. Return ALDC potentiometer fully counterclockwise.

q. OUTPUT FILTER Z114. Output filter Z114 cannot be aligned without a special factory test setup.

r. OVERALL ALIGNMENT. Perform an overall alignment of the MMX()-2 as follows, after alignment of the individual printed circuit boards:

- (1) Make the following preliminary adjustments:
 - (a) All cards aligned and inserted.
 - (b) RF OUTPUT control fully counterclockwise.
 - (c) Output frequency set to 29.9999 mc.
 - (d) CARRIER control fully counterclockwise.
 - (e) MODE switch to ISB position.
 - (f) EXCITER switch to ON position.
 - (g) Hewlett-Packard 200 CD generator (audio) connected to 600-ohm input on rear panel to both sidebands. (One side grounded.)
 - (h) MIKE/LINE controls to zero.
 - (i) METER switch to Q1 position.
 - (j) ALDC control (rear panel) fully counterclockwise.
- (2) Place Z101 (J101) on extender card and connect spectrum analyzer to J101-8 and ground lead to pin J. Adjust analyzer for 12 MHz display. Adjust capacitor C56 so that 11 MHz and 13 MHz are at least -80 db from 12 MHz level.
- (3) Set frequency on front panel to 0.99999 MHz and connect analyzer to J101-P and ground lead to pin R. Display 13 MHz. Adjust capacitor C80 so that 12 MHz and 14 MHz are at least -80 db from 13 MHz level. Return frequency to 1.99999 MHz.
- (4) Connect analyzer to J101-S and ground lead to pin 15. Display 8 MHz. Adjust capacitor C64 so that 7 MHz and 9 MHz are at least -80 db from 8 MHz level.
- (5) Place Z101 into unit and place Z102 (comb filter A) on extender card. Remove comb filter B, Z103 from unit. Connect analyzer to J102-J and ground lead to pin 8. Display 1 MHz. Adjust capacitor C68 so that 100 kHz spurs above and below 1 MHz are at least -80 db from 1 MHz level.
- (6) Repeat step 5 using 1.2 MHz, pin P and ground lead to pin 13, and C69.
- (7) Repeat step 5 using 1.4 MHz, pin F and ground lead to pin 5, and C70.
- (8) Repeat step 5 using 1.6 MHz, pin L and ground lead to pin 10, and C71.
- (9) Repeat step 5 using 1.8 MHz, pin 4 and ground lead to pin D, and C72.
- (10) Place comb filter B, Z103 on extender card and remove comb filter A, Z102 from unit. Connect analyzer to J103-J and ground lead to pin 8. Display 1.1 MHz. Adjust capacitor C68 so that 100 kHz spurs above and below 1.1 MHz are at least -80 db from 1.1 MHz level.
- (11) Repeat step 10 using 1.3 MHz, pin P and ground lead to pin 13, and C69.
- (12) Repeat step 10 using 1.5 MHz, pin F and ground lead to pin 5, and C70.
- (13) Repeat step 10 using 1.7 MHz, pin L and ground lead to pin 10, and C71.
- (14) Repeat step 10 using 1.9 MHz, pin 4 and ground lead to pin D, and C72.
- (15) Front panel MONITOR meter shall indicate in the green region marked Q1.

(16) Turn METER switch to Q2 position. Front panel MONITOR meter shall indicate green in the region marked Q2.

(17) Turn METER switch to Q3 position. Front panel MONITOR meter shall indicate in the green region marked Q3.

(18) Using Ballantine 314 meter, adjust audio input on rear panel to 69 (-20 dbm) single tone.

(19) Connect oscilloscope to TP11 of side-band generator Z107 and set LSB MIKE/LINE control for 0.09 volt peak-to-peak.

(20) Set METER switch on front panel to LSB position. The front panel MONITOR meter must read 2/5 or full scale. Return LSB MIKE/LINE control to zero.

(21) Connect oscilloscope to TP4 of side-band generator Z107 and set USB MIKE/LINE control for 0.09 volt peak-to-peak.

(22) Set METER switch on front panel to USB position. The front panel MONITOR meter must read 2/5 of full scale. Return USB MIKE/LINE control to zero.

(23) Connect Lavoie spectrum analyzer (LA-40) to RF MON jack on rear panel of unit.

(24) Connect VTVM (Hewlett-Packard 410B) to RF OUT jack across 47-ohm load resistor.

(25) Set CARRIER control fully clockwise and adjust RF OUTPUT control on front panel to 3.5 volts minimum on VTVM.

(26) Connect oscilloscope to output of Exciter. Displayed waveform should be a sharp undistorted sine wave with no modulating signal appearing in any position of the time/cm dial of the oscilloscope.

(27) Set frequency of Exciter to 29.250 MHz. Adjust carrier control fully clockwise (ISB mode). Adjust for 2.5 volts rms output on HP-410B meter. Change frequency to 29.750 MHz and adjust potentiometer R109 on Z112 for equal output.

(28) Find frequency in the 29.00 to 29.9999 MHz range with the minimum output. Adjust potentiometer R97 on Z112 for maximum output at that point.

(29) Turn CARRIER control on front panel fully counterclockwise and set MODE switch to ISB position. Switch audio input to two tones. Adjust MIKE/LINE controls for 4/5 full scale readings on MONITOR meter in appropriate METER switch positions (both sidebands). Adjust RF OUTPUT control for 5.0 volts indication on Hewlett-Packard 410B meter.

(30) Touch up level of tones for equal display by decreasing R34 (USB) or R60 (LSB) on side-band generator Z107.

(31) Display 5.0 volt output signal on analyzer and adjust potentiometers R51 and R71 on translator Z112 alternately for four (4) clear tones (distortion -40 db). Readjust RF OUTPUT control for 5.0 volts, if necessary. Check distortion in sideband (USB/LSB) position of MODE switch. Distortion should be -40 db minimum. Check carrier suppression in USB, LSB and ISB modes (-55 db minimum).

(32) Repeat step 30. Return MODE switch to ISB position.

(33) Attenuate display -3 db using input attenuator of analyzer. Turn CARRIER control on

front panel fully clockwise and adjust potentiometer R27 on carrier generator Z109 for center tone at top line of analyzer as shown in figure 5-9.

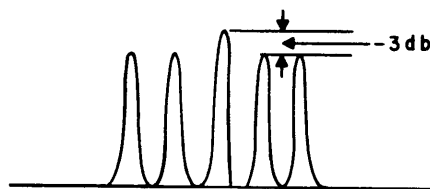

Figure 5-9. Carrier Generator Alignment Waveform

(34) Turn MODE switch to CW position and key unit by front panel KEY jack or by rear panel jumper across key terminals. Adjust potentiometer R20 on carrier generator Z109 for top line on analyzer. Unkey unit. Output should drop to 0 (-60 db) minimum. Key unit.

(35) Adjust potentiometer R47 on carrier generator Z109 until just before signal starts to decrease.

(36) Turn MODE switch to FSK position and adjust potentiometer R56 on frequency shift generator Z108 for top line on analyzer. Turn MODE switch to FAX position. Level should remain the same.

(37) Return MIKE/LINE controls to zero position; switch audio input to single tone and turn MODE switch to AM position. Remove 3 db of attenuation from input attenuator of analyzer.

(38) Adjust potentiometer R69 on carrier generator Z109 for top line on analyzer.

(39) Using LSB or USB MIKE/LINE control, modulate displayed carrier so that sidebands (as measured with input attenuator of analyzer) are 7 db below carrier.

(40) Repeat steps 38 and 39 until the waveform of figure 5-10 is obtained. Distortion should be -25 db minimum below carrier as shown.

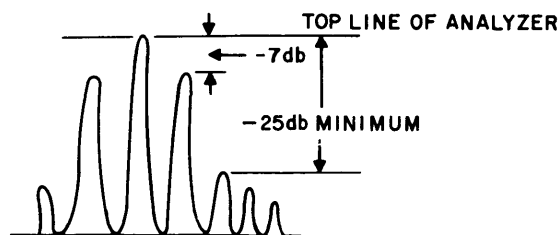

Figure 5-10. Carrier Double-Sideband Modulation Waveform

(41) Return MIKE/LINE control to zero and turn CARRIER control fully clockwise. Turn METER switch to CARRIER position. MONITOR meter should read approximately 4/5 full scale.

Turn METER switch to RF position. MONITOR meter should indicate approximate RF output in volts.

(42) Adjust potentiometer R58 on frequency shift generator Z108 for an output voltage of 5.6 volts on Hewlett-Packard 410B meter, when RF OUTPUT and CARRIER controls are fully clockwise, at frequency of 29.9999 MHz.

(43) Connect 0 - 10 volt power supply to ALDC connector on rear of unit (+ to ground, - to ALDC jack).

(44) Connect counter to vertical output terminals of scope and turn MODE switch to FSK position. Check FSK and readjust if necessary as outlined in alignment procedure for Z108 (paragraph 5-3 l.), except center frequency will be selected by frequency dials on front panel of unit. Check contact keying by shorting and unshorting contact key terminals on rear panel of Exciter.

(45) Turn MODE switch to FAX position and connect 0 - 10 volt dc supply to FAX terminals at rear of unit. Check FAX and readjust if necessary as outlined in alignment procedure for Z108 (paragraph 5-3 l.), except center frequency will be selected by frequency dials on front panel of unit.

(46) Check Exciter minimum output using carrier only for frequencies listed in table 5-5.

TABLE 5-5. EXCITER CARRIER FREQUENCY OUTPUT CHECK

2.0000 MHz	12.2222 MHz	22.0000 MHz
3.3333 MHz	13.5000 MHz	23.5000 MHz
4.4444 MHz	14.4999 MHz	24.0000 MHz
5.5555 MHz	15.0000 MHz	25.0000 MHz
6.6666 MHz	16.0000 MHz	26.0000 MHz
7.7777 MHz	17.0000 MHz	27.0000 MHz
8.8888 MHz	18.0000 MHz	28.0000 MHz
9.9999 MHz	19.9999 MHz	29.0000 MHz
10.0000 MHz	20.0000 MHz	29.9999 MHz
11.1111 MHz	21.0000 MHz	

5-4. REPAIR OF PRINTED CIRCUITRY

a. INTRODUCTION. Repair of the chassis-mounted power supply circuitry follows standard laboratory procedures. Repair of printed circuit cards and card receptacle wiring, however, require the special tools and techniques as outlined here. Section 6, Parts List, lists all replaceable parts and their circuit symbol numbers. These symbol numbers are shown on the schematics contained in Section 7 and located on figures 5-11 through 5-27.

NOTE

Replacement of parts on the printed circuit boards requires the special tools described in paragraph 5-4 b through d.

b. REPLACEMENT OF PARTS. When replacing a part on a board, it is necessary to remove the

old part from the board by melting the solder on all the component pins. Soldering the new part to the board is done pin-by-pin with conventional methods.

c. CHECKING PRINTED CIRCUIT CONDUCTORS. Breaks in the conducting strip (foil) on a printed circuit board can cause permanent or intermittent trouble. In many instances, these breaks will be so small that they cannot be detected by the naked eye. These invisible cracks (breaks) can be located only with the aid of a powerful magnifying glass.

To check out and locate trouble in the conducting strips of a printed circuit board, set up a multimeter (one which does not use a current in excess of 1 ma) for making point-to-point resistance tests, using needle probes. Insert one point into the conducting strip, close to the end of terminal, and place the other probe on the terminal or opposite end of the conducting strip. The multimeter should indicate continuity. If the multimeter indicates an open circuit, drag the probe along the strip (or if the conducting strip is coated, puncture the coating at intervals) until the multimeter indicates continuity. Mark this area; then use a magnifying glass to locate the fault in the conductor.

CAUTION

Before using an ohmmeter for testing a circuit containing transistors or other voltage-sensitive semi-conductors, check the current it passes under test on all ranges. DO NOT use a range that passes more than 1 ma.

d. REPAIR OF PRINTED CONDUCTORS. If the break in the conductor strip is small, lightly scrape away any coating covering the area of conducting strip to be repaired. Clean the area with a firm-bristly brush and approved solvent. Then repair the cracked or broken area of the conducting strip by flowing solder over the break. Considerable care must be exercised to keep the solder from flowing onto an adjacent strip.

If a strip is burned out, or fused, cut and remove the damaged strip. Connect a length of insulated wire across the breach or from solder-point to solder point.

After the repairs are completed, clean the repaired area with a stiff brush and solvent. Allow the board to dry thoroughly, and then coat the repaired area with an epoxy resin or similar compound. This coating not only will protect the repaired area, but will help to strengthen it.

CAUTION

After repairs, check the board for solder drippings; they may cause shorts.

Frequently, a low-resistance leakage path will be created by moisture and/or dirt that has carbonized onto the phenolic board. This leakage can

be detected by measuring the suspected circuit with a multimeter. To overcome this condition, thoroughly clean the carbonized area with solvent and a stiff brush. If this does not remove it, use a scraping tool (spade end of a solder-air tool or its equivalent) to remove the carbon, or drill a hole through the leakage path to break the continuity of the leakage. When the drilling method is used, be careful not to drill into a part mounted on the other side.

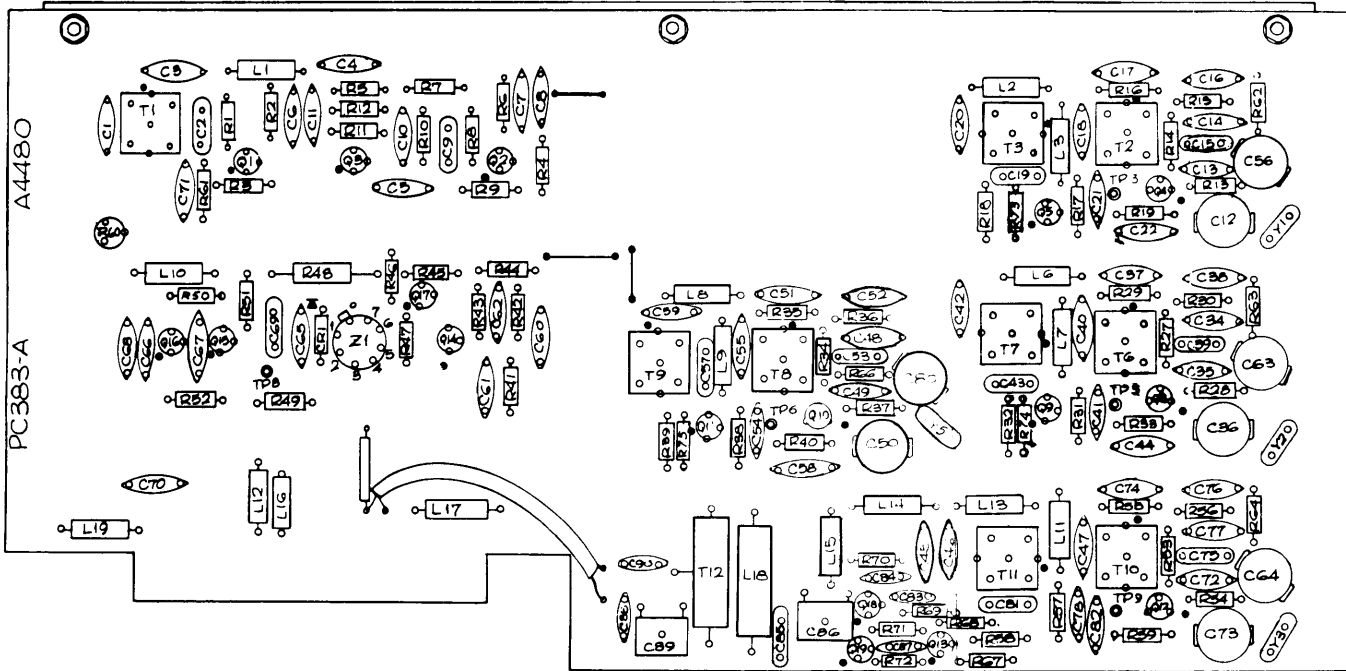

Figure 5-11. Spectrum Generator Z101, Board Component Locations

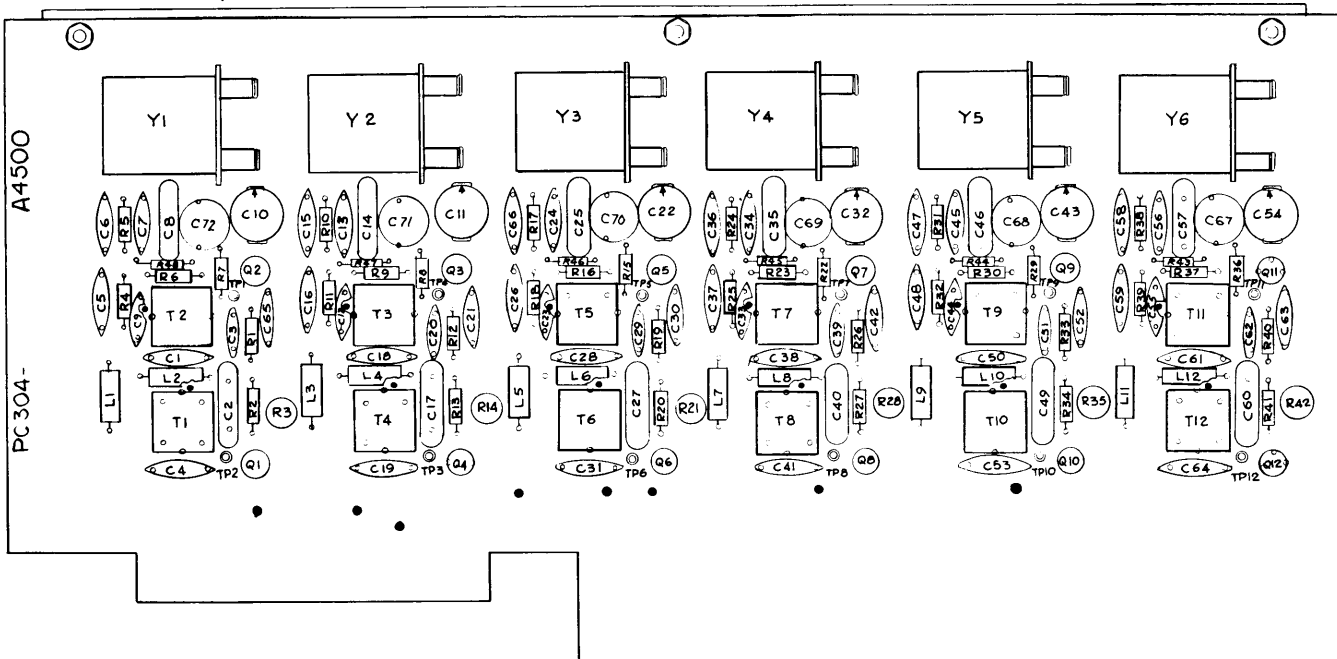

Figure 5-12. Comb Filter Z102, Board Component Locations

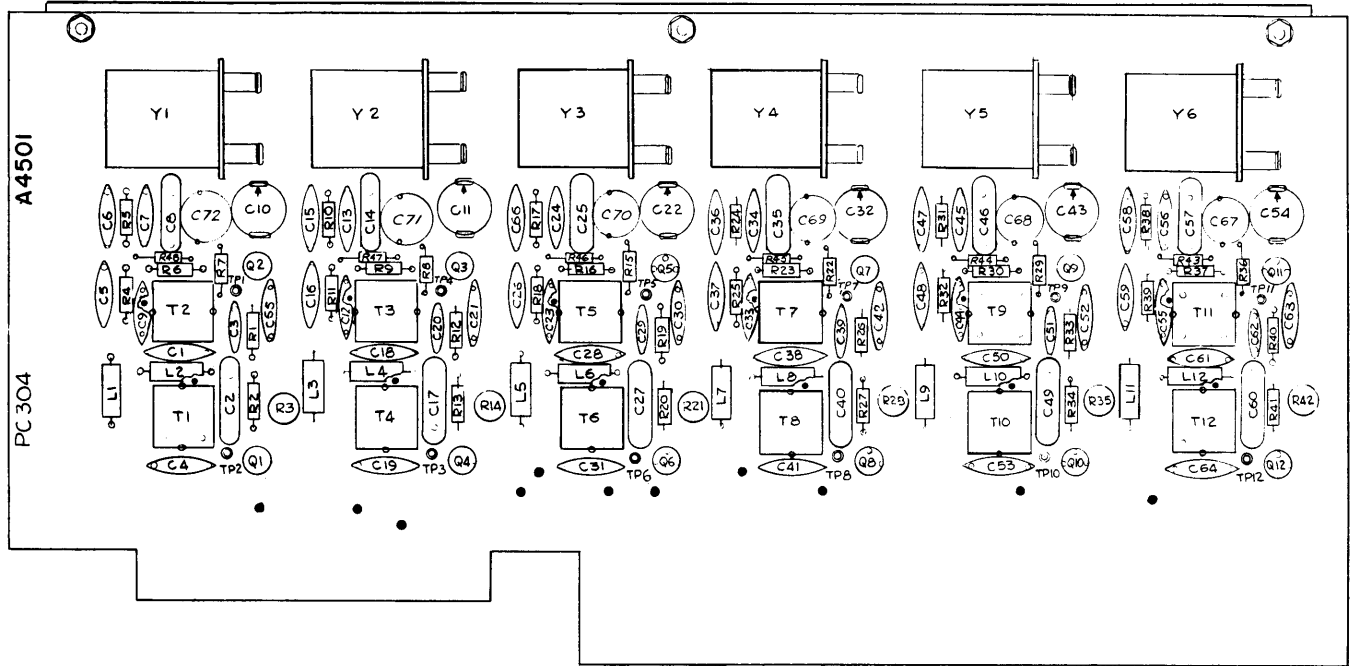

Figure 5-13. Comb Filter Z103, Board Component Locations

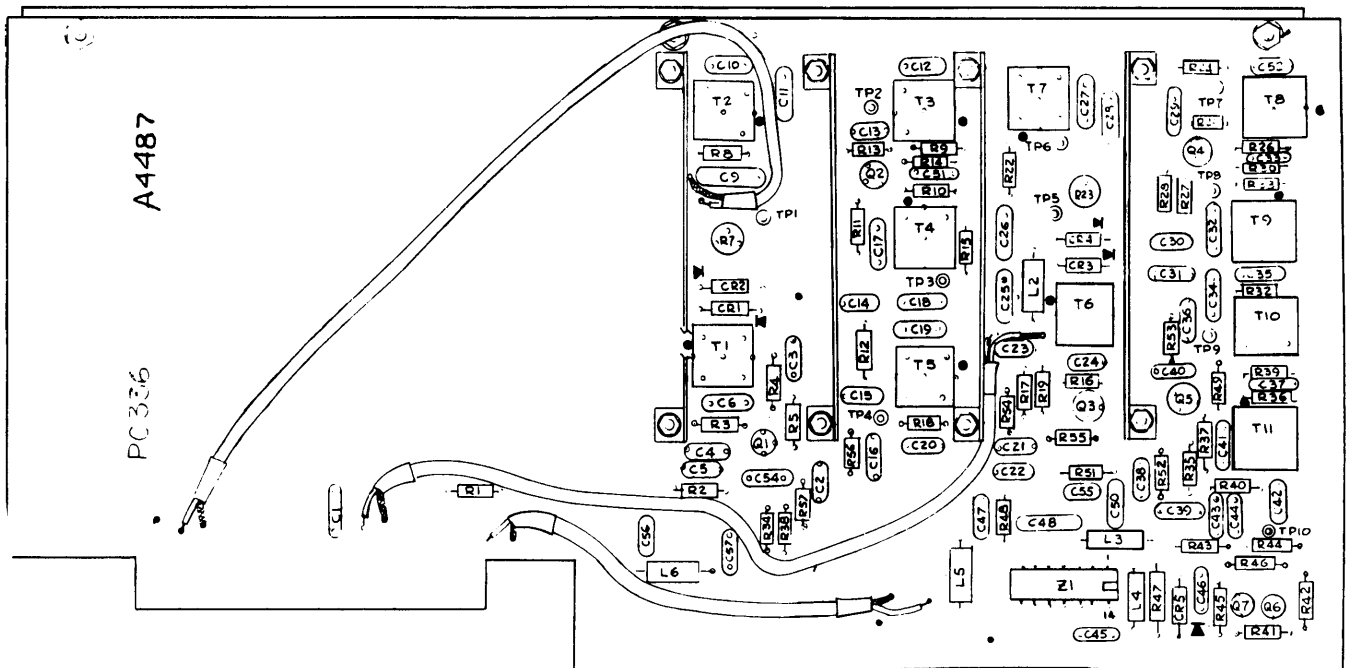

Figure 5-14. Single Mixer-Divider Z104, Board Component Locations

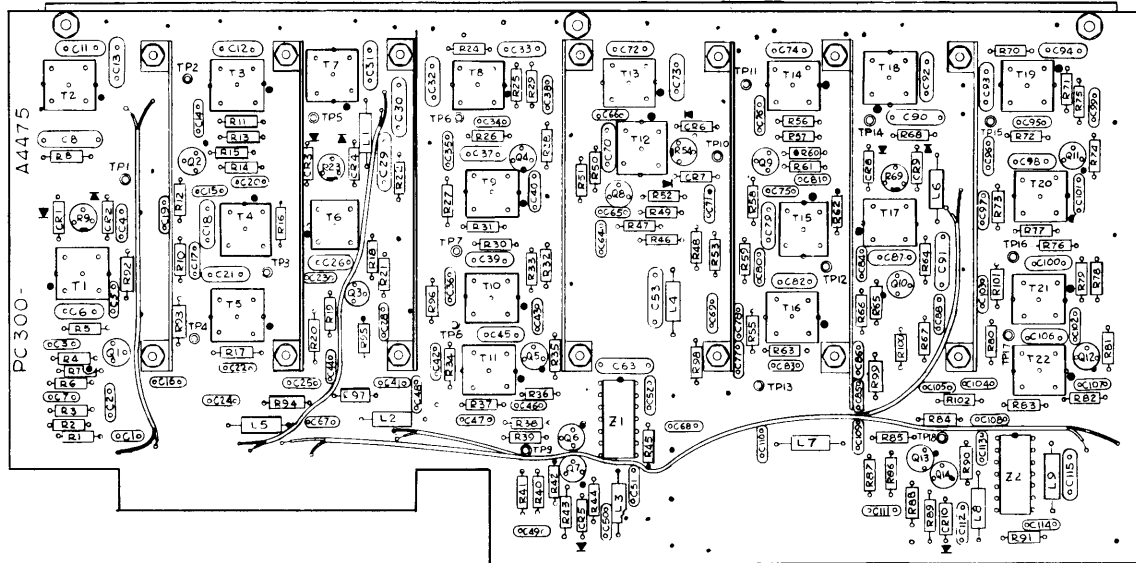

Figure 5-15. Dual Mixer-Divider Z105, Board Component Locations

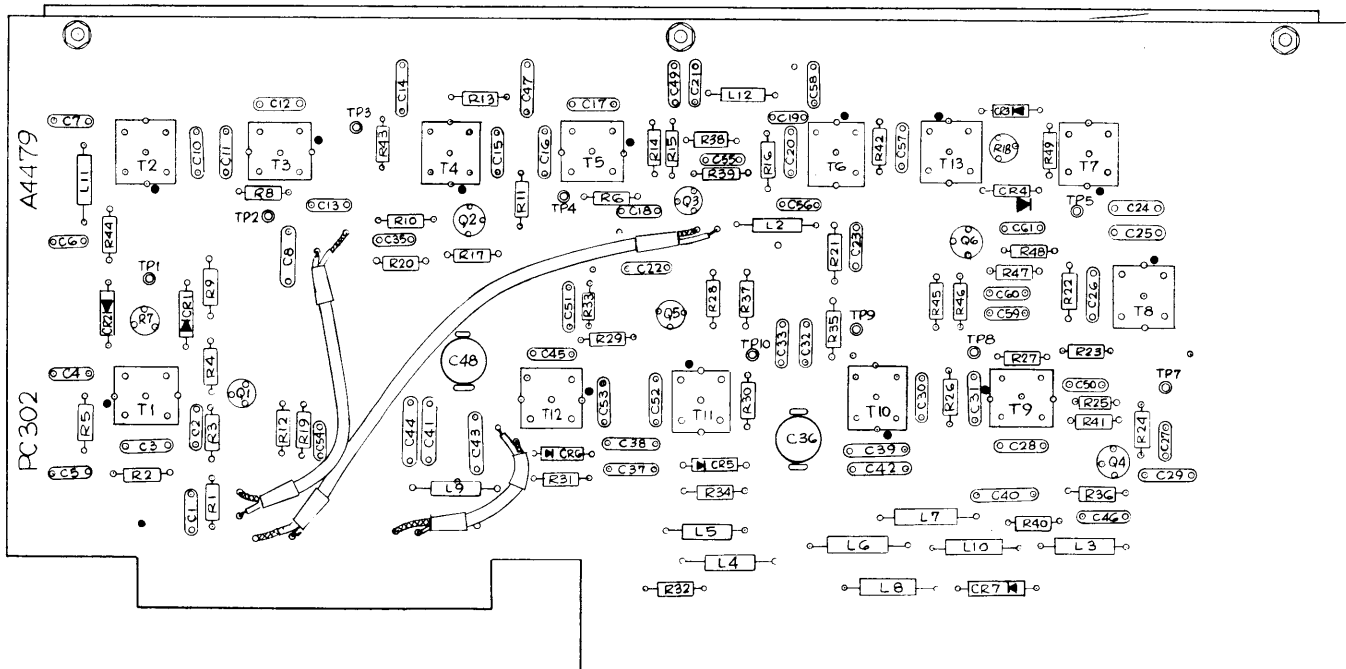

Figure 5-16. Final Mixer Z106, Board Component Locations

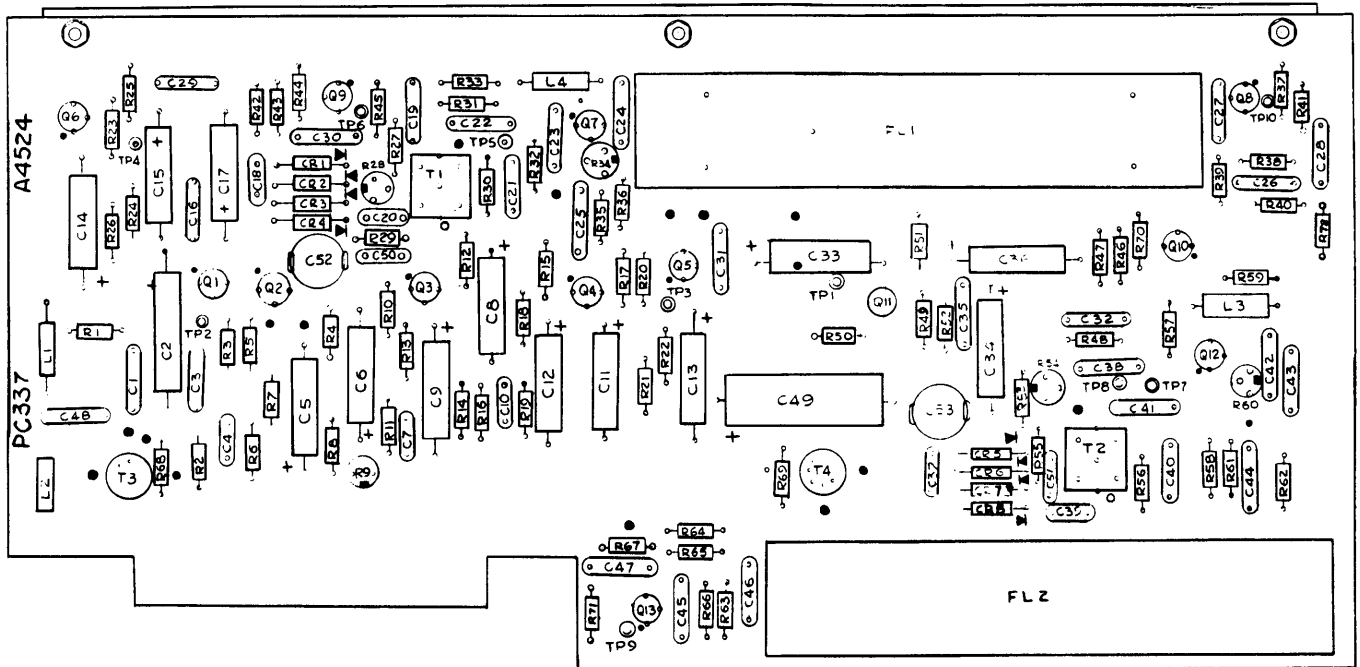

Figure 5-17. Sideband Generator Z107, Board Component Locations

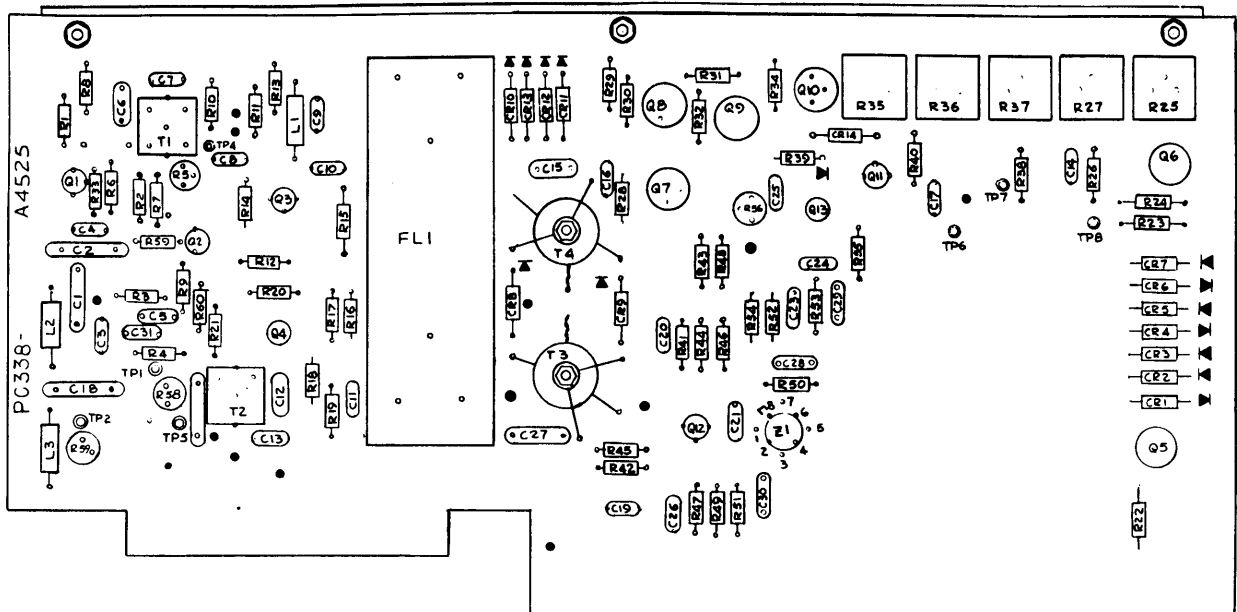

Figure 5-18. Frequency Shift Generator Z108, Board Component Locations

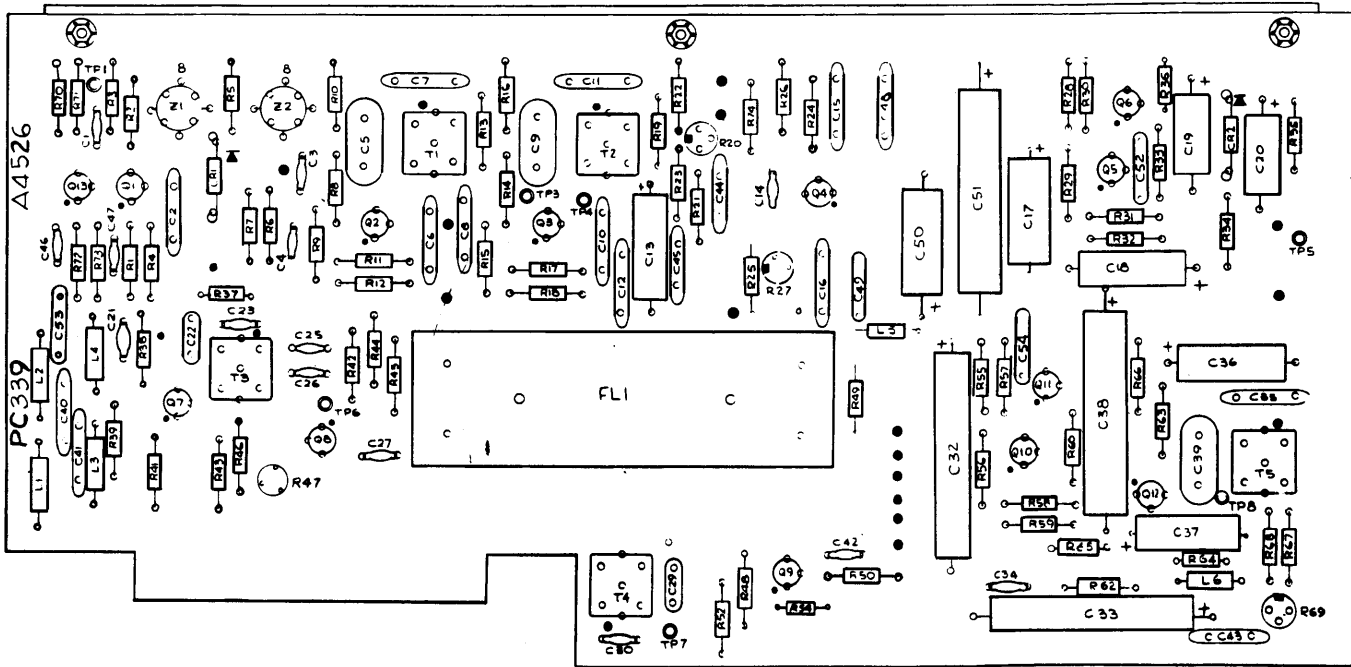

Figure 5-19. Carrier Generator Z109, Board Component Locations

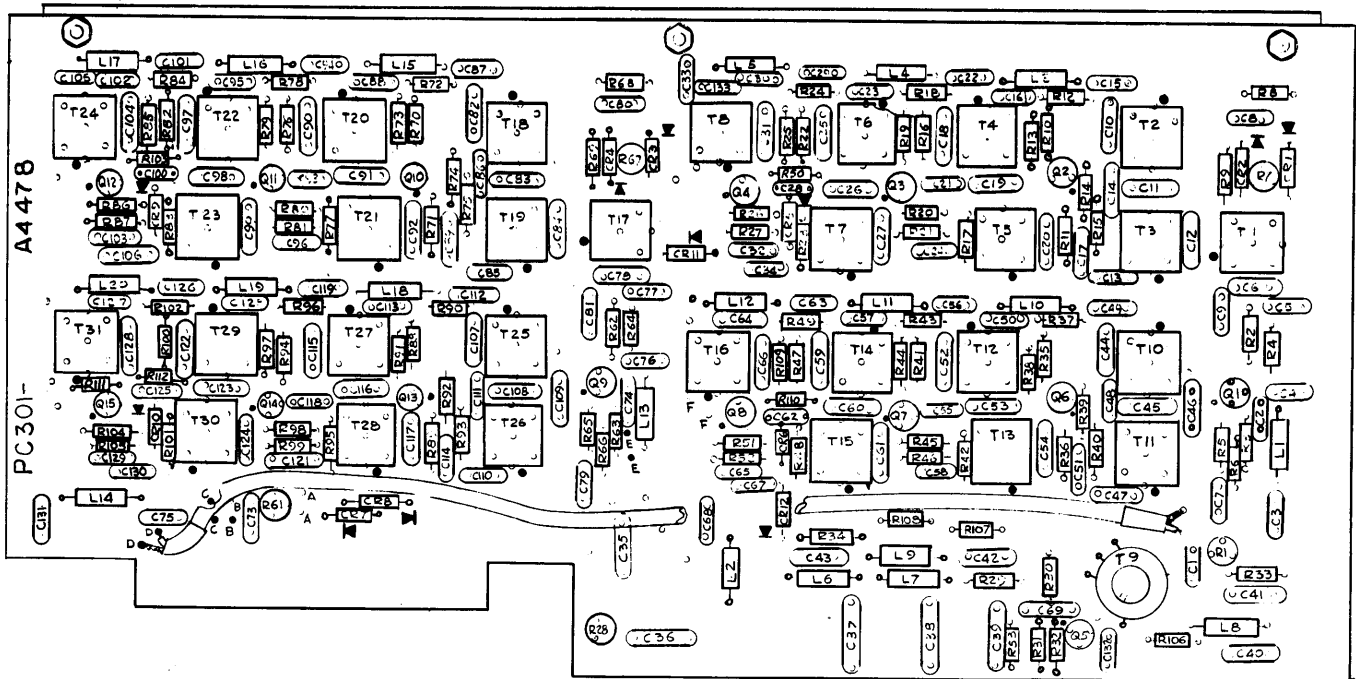

Figure 5-20. Step Generator Z110, Board Component Locations

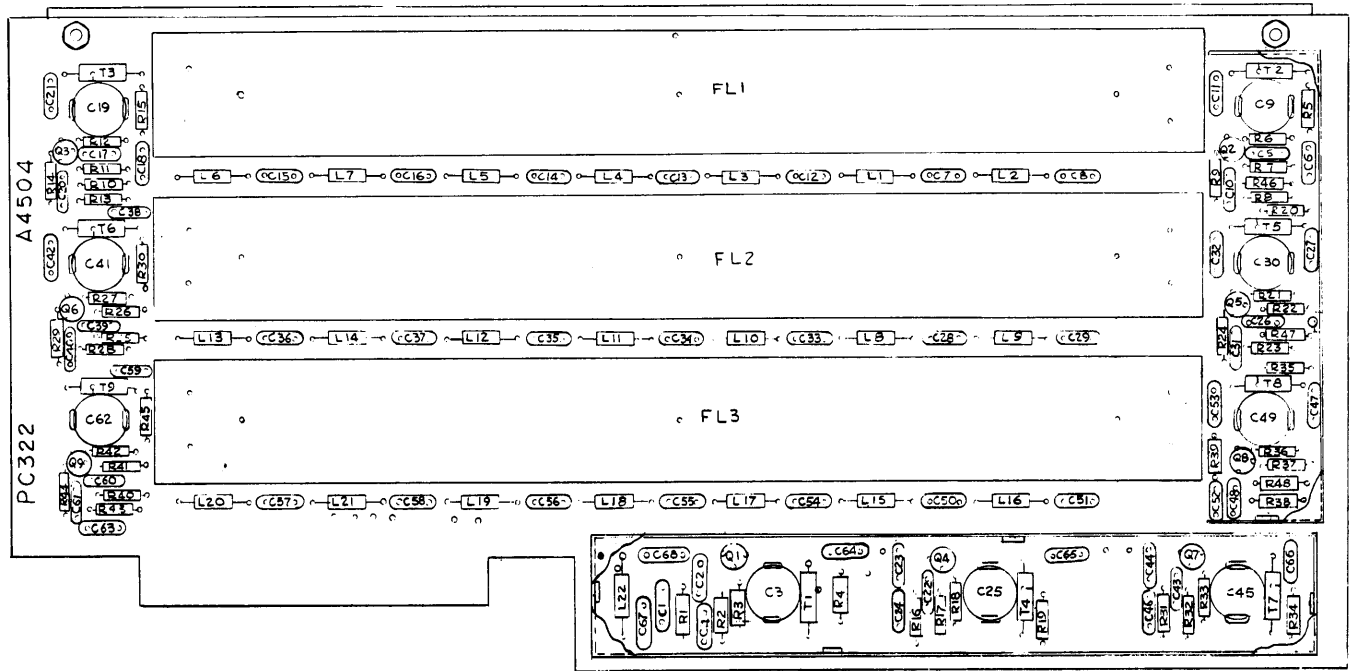

Figure 5-21. Step Generator Z111, Board Component Locations

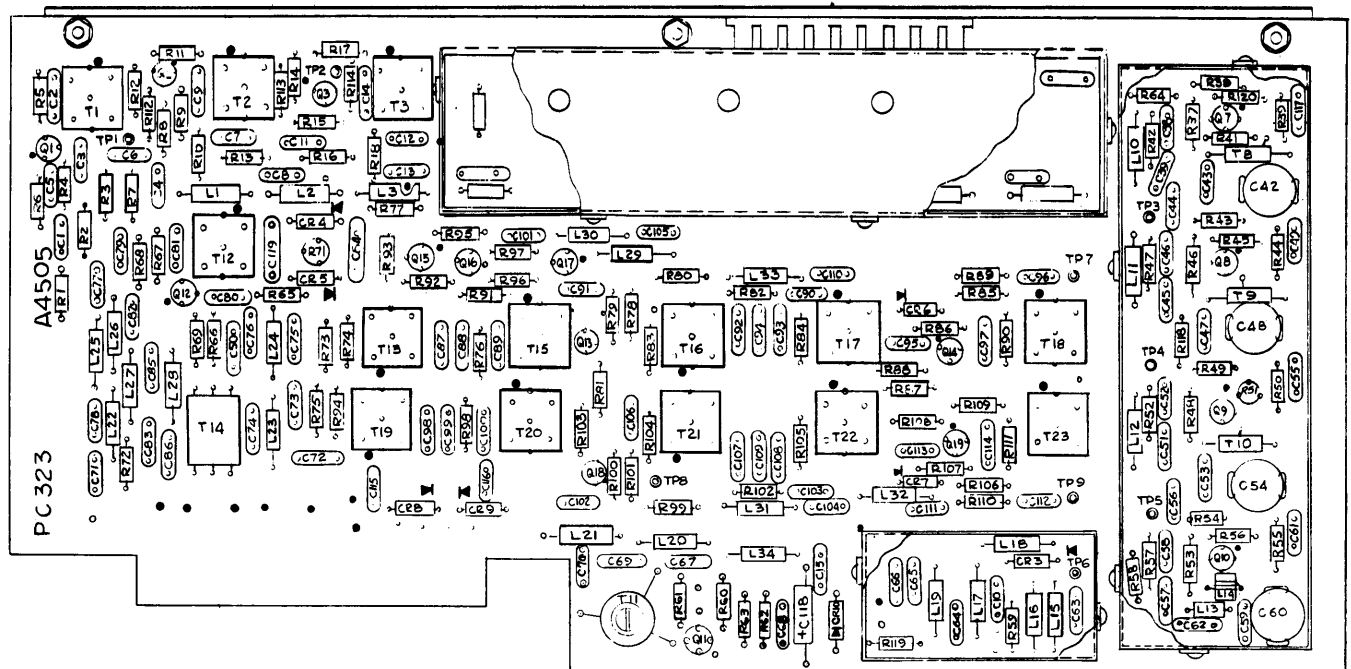

Figure 5-22. Translator Z112, Board Component Locations

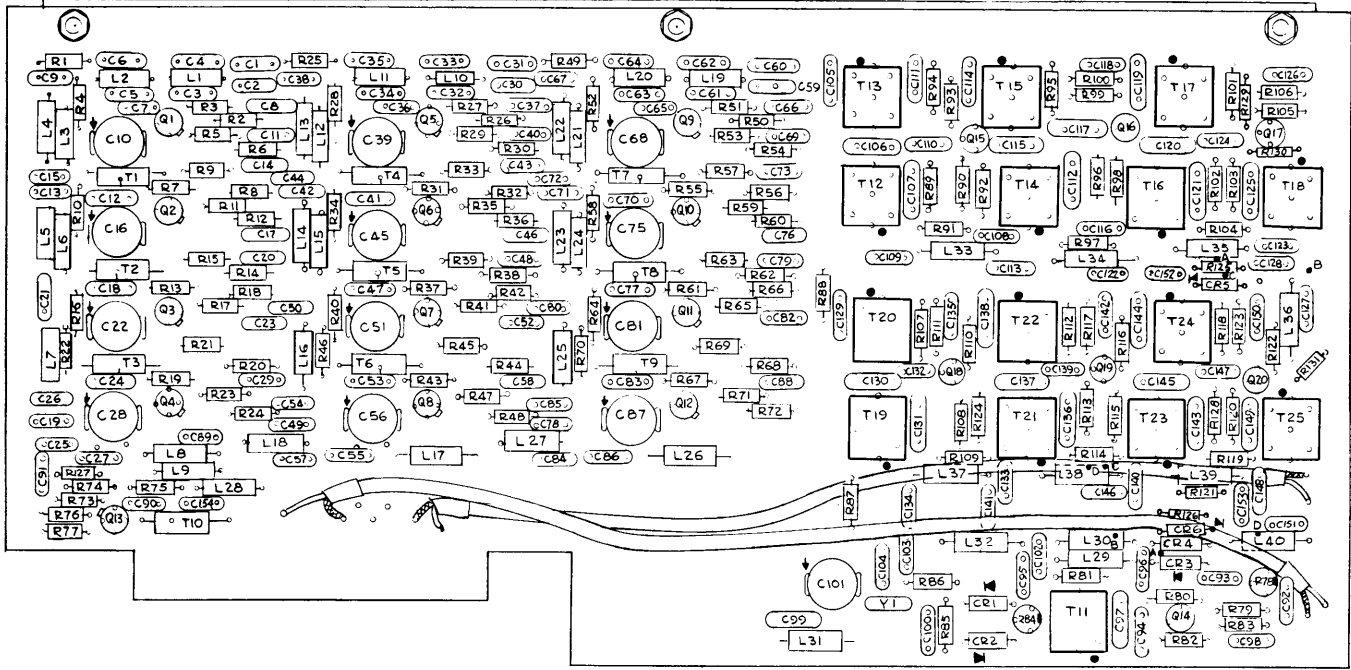

Figure 5-23. Step Generator Z113, Board Component Locations

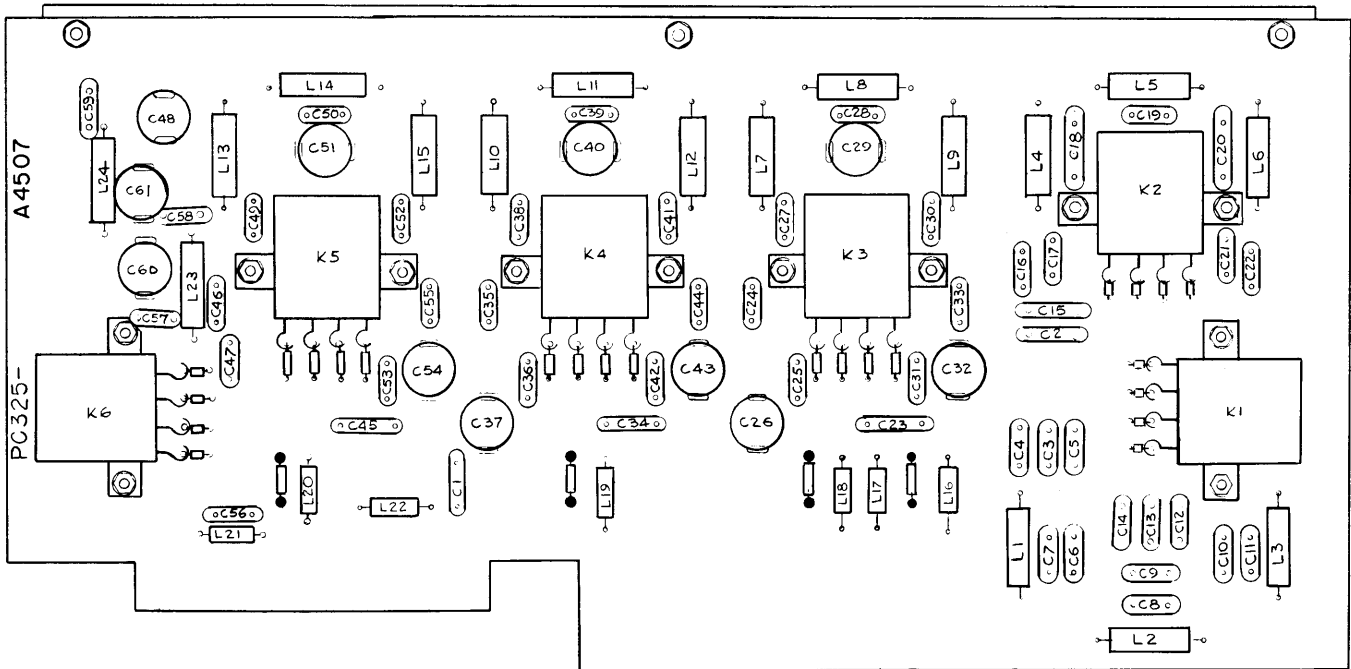

Figure 5-24. Output Filter Z114, Board Component Locations

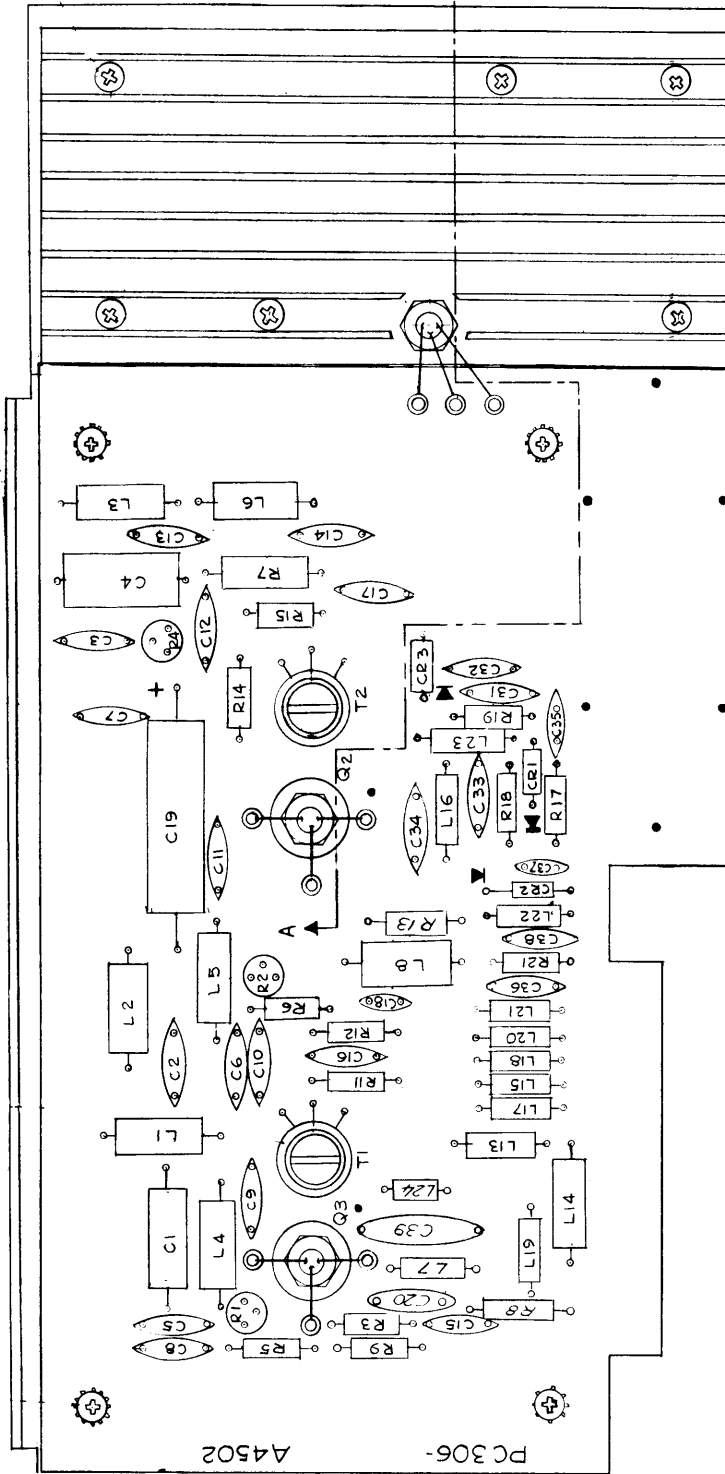

Figure 5-25. RF Output Z115, Board Component Locations

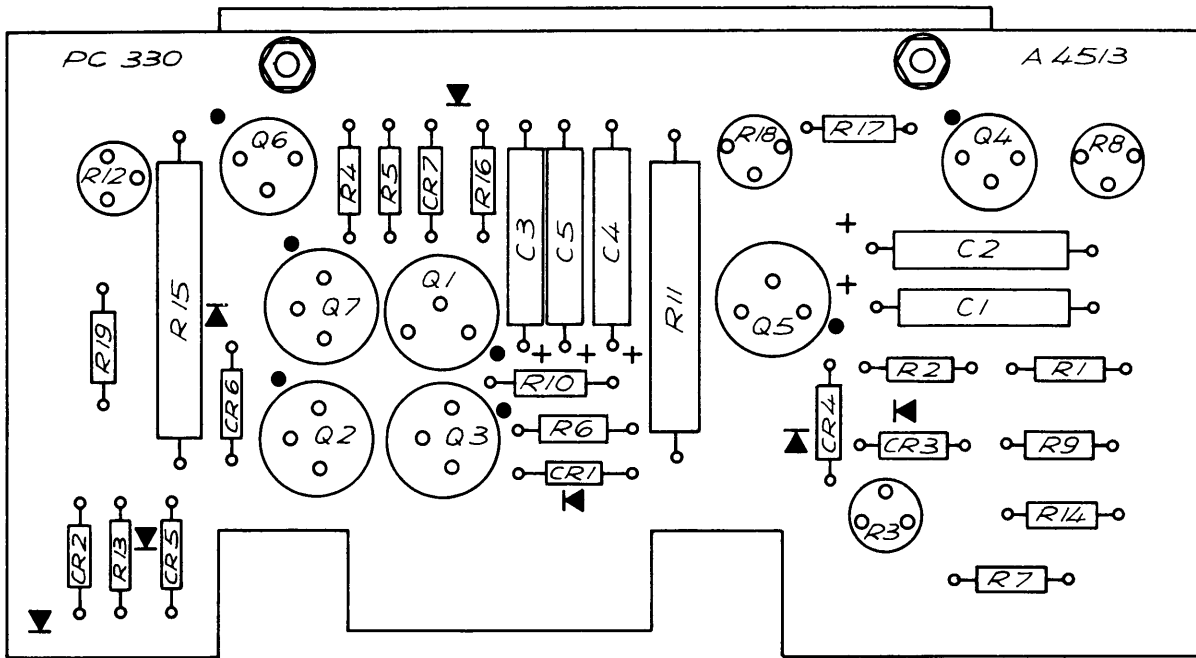

Figure 5-26. Power Supply Z303, Board Component Locations

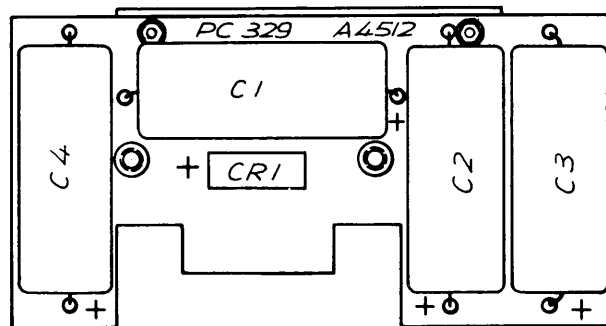

Figure 5-27. Power Supply Z304, Board Component Locations

SECTION 6

PARTS LIST

6-1. INTRODUCTION

The parts list presented in this section is a cross-reference list of parts identified by a reference designation and TMC part number. In most cases, parts appearing on schematic diagrams are assigned reference designations in accordance with MIL-STD-16. Wherever practicable, the reference designation is marked on the equipment, close to the part it identifies. In most cases, mechanical and electro-mechanical parts have TMC part numbers stamped on them.

To expedite delivery when ordering any part, specify the following:

- a. Assembly number and Reference symbol - ex. A-4475 - C1
- b. Description as indicated in parts list.
- c. TMC part number.
- d. Model and serial numbers of the equipment containing the part being replaced; this can be obtained from the equipment nameplate.

For replacement parts not covered by warranty (refer to warranty sheet in front of manual), address all purchase orders to:

The Technical Materiel Corporation
Attention: Sales Department
700 Fenimore Road
Mamaroneck, New York

<u>Assembly or Sub-Assembly</u>	<u>Page</u>
Mixer Divider, Dual (A-4475)	6-2
Step Generator A (A-4478)	6-12
Mixer Final (A-4479)	6-23
Spectrum Generator (A-4480)	6-29
Mixer Divider $\frac{1}{2}$ BD (A-4487)	6-37
Comb Filter A (A-4500)	6-43
Comb Filter B (A-4501)	6-49
R. F. Output (A-4502)	6-55
Step Generator B (A-4504)	6-59
Translator (A-4505)	6-64
Step Generator C (A-4506)	6-76
Filter (A-4507)	6-89
P.C. BD A Power Supply (A-4512)	6-93
P.C. BD B Power Supply (A-4513)	6-94
Sideband Generator (A-4524)	6-96
Frequency Shift Generator (A-4525)	6-102
Carrier Generator (A-4526)	6-108
120 MC Generator (A-4600)	6-115
Filter (A-4654)	6-118
Power Supply (AX652)	6-119
Switch Assembly Bracket (BMA 101)	6-120
Frame Assembly (BMA 103)	6-121
Sub Assembly (BMA 105)	6-122
Heat Sink Assembly (BMA 173)	6-128
Chassis, Assembly, Main (AX676)	6-129
Resistor, board, Assembly (A 4592)	6-130
Resistor, board, Assembly (A4593)	6-131

MIXER DIVIDER
A-4475

REF SYMBOL	DESCRIPTION	TMC PART NUMBER
C1	Capacitor, Fixed, Ceramic, 1000 uuf, <u>GMV</u> , 500 WVDC	CC100-29
C2 thru C5	Same as C1	
C6	Capacitor, Fixed, Mica, 220 uuf, <u>+2%</u> , 500 WVDC	CM111F221G5S
C7	Same as C1	
C8	Capacitor, Fixed, Mica, 1200 uuf, <u>+½%</u> , 500 WVDC	CM11SF122D5S
C9	Not used	
C10	Not used	
C11	Same as C6	
C12	Same as C6	
C13	Capacitor, Fixed, Mica, 5 uuf, <u>+10%</u> , 500 WVDC	CM111C050K5S
C14 thru C17	Same as C1	
C18	Same as C6	
C19	Same as C13	
C20	Same as C1	
C21	Same as C6	
C22 thru C25	Same as C1	
C26	Capacitor, Fixed, Mica, 180 uuf, <u>+2%</u> , 500 WVDC	CM111F181G5S
C27	Not used	
C28	Same as C1	
C29	Capacitor, Fixed, Mica, 1500 uuf, <u>+½%</u> , 500 WVDC	CM112F152D5S
C30	Same as C29	
C31	Capacitor, Fixed, Mica, 130 uuf, <u>+2%</u> , 500 WVDC	CM111F131J5S

MIXER DIVIDER
A-4475

REF SYMBOL	DESCRIPTION	TMC PART NUMBER
C32	Capacitor, Fixed, Mica, 12 uuf, <u>±5%</u> , 500 WVDC	CM111C120J5S
C33	Same as C31	
C34 thru C36	Same as C1	
C37	Same as C31	
C38	Same as C1	
C39	Same as C31	
C40	Same as C32	
C41 thru C44	Same as C1	
C45	Same as C31	
C46 thru C49	Same as C1	
C50	Capacitor, Fixed, Mica, .01 uf, <u>±20%</u> , 500 WVDC	CC100-41
C51	Same as C50	
C52	Same as C50	
C53	Same as C8	
C54 thru C62	Not used	
C63	Same as C8	
C64 thru C69	Same as C1	
C70	Same as C6	
C71	Same as C1	

MIXER DIVIDER
A-4475

REF SYMBOL	DESCRIPTION	TMC PART NUMBER
C72	Same as C6	
C73	Same as C13	
C74	Same as C6	
C75 thru C78	Same as C1	
C79	Same as C6	
C80	Same as C13	
C81	Same as C1	
C82	Same as C6	
C83 thru C86	Same as C1	
C87	Same as C26	
C88	Same as C1	
C89	Not used	
C90	Same as C29	
C91	Same as C29	
C92	Same as C31	
C93	Same as C32	
C94	Same as C31	
C95 thru C97	Same as C1	
C98	Same as C31	
C99	Same as C1	

MIXER DIVIDER
A-4475

REF SYMBOL	DESCRIPTION	TMC PART NUMBER
C100	Same as C31	
C101	Same as C32	
C102 thru C105	Same as C1	
C106	Same as C31	
C107 thru C111	Same as C1	
C112 thru C114	Same as C50	
C115	Same as C8	
CR1, CR2	Semiconductor Device Diode - Matched Pair	DD139
CR3, CR4	Same as CR1, CR2	
CR5	Semiconductor, Device Diode	1N752
CR10	Same as CR5	
L1	Coil, Radio Frequency, fixed, 8.2 uh, <u>+10%</u> , molded case	CL275-8R2
L2	Coil, Radio Frequency, fixed, 120 uh, <u>+10%</u> , molded case	CL275-121
L3	Coil, Radio Frequency, fixed, 220 uh, <u>+10%</u> , molded case	CL275221
L4	Coil, Radio Frequency, fixed, 15 uh, <u>+10%</u> , molded case	CL275-150
L5	Same as L2	
L6	Same as L1	
L7	Same as L2	

MIXER DIVIDER
A-4475

REF SYMBOL	DESCRIPTION	TMC PART NUMBER
L8	Same as L3	
L9	Same as L4	
Q1	Transistor	2N3646
Q2 thru Q14	Same as Q1	
R1	Resistor, Fixed, Composition, 390 ohms, $\pm 5\%$, $\frac{1}{4}$ watt	RC07GF391J
R2	Resistor, Fixed, Composition, 56 ohms, $\pm 5\%$, $\frac{1}{4}$ watt	RC07GF560J
R3	Resistor, Fixed, Composition, 1500 ohms, $\pm 5\%$, $\frac{1}{4}$ watt	RC07GF152J
R4	Resistor, Fixed, Composition, 8200 ohms, $\pm 5\%$, $\frac{1}{4}$ watt	RC07GF822J
R5	Resistor, Fixed, Composition, 680 ohms, $\pm 5\%$, $\frac{1}{4}$ watt	RC07GF681J
R6	Resistor, Fixed, Composition, 330 ohms, $\pm 5\%$, $\frac{1}{4}$ watt	RC07GF331J
R7	Resistor, Fixed, Composition, 15 ohms, $\pm 5\%$, $\frac{1}{4}$ watt	RC07GF150J
R8	Resistor, Fixed, Composition, 120 ohms, $\pm 5\%$, $\frac{1}{4}$ watt	RC07GF121J
R9	Resistor, Variable, Composition, 500 ohms, $\pm 30\%$, 0.5 watts	RV124-1-501
R10	Resistor, Fixed, Composition, 1000 ohms, $\pm 5\%$, $\frac{1}{4}$ watt	RC07GF102J
R11	Same as R1	
R12	Resistor, Fixed, Composition, 27000 ohms, $\pm 5\%$, $\frac{1}{4}$ watt	RC07GF273J
R13	Resistor, Fixed, Composition, 3300 ohms, $\pm 5\%$, $\frac{1}{4}$ watt	RC07GF332J
R14	Resistor, Fixed, Composition, 470 ohms, $\pm 5\%$, $\frac{1}{4}$ watt	RC07GF471J
R15	Same as R7	
R16	Same as R6	
R17	Same as R5	
R18	Resistor, Fixed, Composition, 4700 ohms, $\pm 5\%$, $\frac{1}{4}$ watt	RC07GF472J

MIXER DIVIDER
A-4475

REF SYMBOL	DESCRIPTION	TMC PART NUMBER
R19	Resistor, Fixed, Composition, 10000 ohms, $\pm 5\%$, $\frac{1}{4}$ watt	RC07GF103J
R20	Same as R5	
R21	Same as R6	
R22	Resistor, Fixed, Composition, 47 ohms, $\pm 5\%$, $\frac{1}{4}$ watt	RC07GF470J
R23	Same as R9	
R24	Resistor, Fixed, Composition, 6800 ohms, $\pm 5\%$, $\frac{1}{4}$ watt	RC07GF682J
R25	Same as R13	
R26	Same as R12	
R27	Same as R10	
R28	Same as R7	
R29	Resistor, Fixed, Composition, 560 ohms, $\pm 5\%$, $\frac{1}{4}$ watt	RC07GF561J
R30	Same as R24	
R31	Resistor, Fixed, Composition, 270 ohms, $\pm 5\%$, $\frac{1}{4}$ watt	RC07GF271J
R32	Same as R13	
R33	Resistor, Fixed, Composition, 18000 ohms, $\pm 5\%$, $\frac{1}{4}$ watt	RC07GF183J
R34	Same as R10	
R35	Same as R7	
R36	Same as R29	
R37	Resistor, Fixed, Composition, 220 ohms, $\pm 5\%$, $\frac{1}{4}$ watt	RC07GF221J
R38	Resistor, Fixed, Composition, 100000 ohms, $\pm 5\%$, $\frac{1}{4}$ watt	RC07GF104J
R39	Same as R38	

MIXER DIVIDER
A-4475

REF SYMBOL	DESCRIPTION	TMC PART NUMBER
R40	Resistor, Fixed, Composition, 2200 ohms, ±5%, ¼ watt	RC07GF222J
R41	Same as R19	
R42	Resistor, Fixed, Composition, 3900 ohms, ±5%, ¼ watt	RC07GF392J
R43	Resistor, Fixed, Composition, 100 ohms, ±5%, ½ watt	RC20GF101J
R44	Same as R40	
R45	Same as R5	
R46	Same as R8	
R47	Same as R1	
R48	Same as R2	
R49	Same as R3	
R50	Same as R4	
R51	Same as R5	
R52	Same as R7	
R53	Same as R6	
R54	Same as R9	
R55	Same as R10	
R56	Same as R1	
R57	Same as R13	
R58	Same as R12	
R59	Same as R10	
R60	Same as R7	
R61	Same as R14	

MIXER DIVIDER
A-4475

REF SYMBOL	DESCRIPTION	TMC PART NUMBER
R62	Same as R6	
R63	Same as R5	
R64	Same as R18	
R65	Same as R19	
R66	Same as R5	
R67	Same as R6	
R68	Same as R22	
R69	Same as R9	
R70	Same as R24	
R71	Same as R13	
R72	Same as R12	
R73	Same as R10	
R74	Same as R7	
R75	Same as R29	
R76	Same as R24	
R77	Same as R31	
R78	Same as R13	
R79	Same as R33	
R80	Same as R10	
R81	Same as R7	
R82	Same as R29	
R83	Resistor, Fixed, Composition, 220 ohms, $\pm 5\%$, $\frac{1}{2}$ watt	RC20GF221J
R84	Same as R38	
R85	Same as R38	

MIXER DIVIDER
A-4475

REF SYMBOL	DESCRIPTION	TMC PART NUMBER
R86	Same as R40	
R87	Same as R19	
R88	Same as R42	
R89	Same as R43	
R90	Same as R40	
R91	Same as R5	
R92 thru R94	Same as R10	
R95	Resistor, Fixed, Composition, 18 ohms, $\pm 5\%$, $\frac{1}{4}$ watt	RC07GF180J
R96	Same as R29	
R97	Same as R29	
R98	Same as R10	
R99	Same as R10	
R100	Same as R29	
R101	Same as R29	
R102	Same as R29	
T1	Transformer, Radio Frequency, tuned	TT285-4
T2	Transformer, Radio Frequency, tuned	TT285-2
T3 thru T5	Same as T2	
T6	Transformer, Radio Frequency, tuned	TT285-17
T7	Transformer, Radio Frequency, tuned	TT285-3
T8	Same as T1	
T9	Same as T7	

MIXER DIVIDER
A-4475

REF SYMBOL	DESCRIPTION	TMC PART NUMBER
T10 thru T12	Same as T1	
T13 thru T16	Same as T2	
T17	Same as T6	
T18	Same as T7	
T19	Same as T1	
T20	Same as T7	
T21	Same as T1	
T22	Same as T1	
Z1	Network, Decade Counter	NW134
Z2	Same as Z1	

STEP GENERATOR A A-4478

REF SYMBOL	DESCRIPTION	TMC PART NUMBER
C1	Capacitor, Fixed, Ceramic, 1,000 uuf, GMV, 500 WVDC	CC100-29
C2 thru C5	Same as C1	
C6	Capacitor, Fixed, Mica, 120 uuf, $\pm 2\%$, 500 WVDC	CM111F121G5S
C7 thru C9	Same as C1	
C10	Capacitor, Fixed, Mica, 150 uuf, $\pm 1\%$, 500 WVDC	CM111F151F5S
C11	Capacitor, Fixed, Mica, 5 uuf, $\pm 10\%$, 500 WVDC	CM111C050K5S
C12	Same as C10	
C13	Capacitor, Fixed, Ceramic, 20,000 uuf, $+80-20\%$, 25 WVDC	CC100-40
C14 thru C17	Same as C1	
C18	Same as C10	
C19	Same as C11	
C20	Same as C10	
C21 thru C24	Same as C1	
C25	Same as C10	
C26	Same as C11	
C27	Same as C10	
C28 thru C30	Same as C1	
C31	Capacitor, Fixed, Mica, 47 uuf, $\pm 2\%$, 500 WVDC	CM111E470G5S

STEP GENERATOR A A-4478

REF SYMBOL	DESCRIPTION	TMC PART NUMBER
C32	Same as C1	
C33	Same as C1	
C34	Same as C13	
C35	Capacitor, Fixed, Ceramic, .1 uf, +80-20%, 100 WVDC	CC100-28
C36 thru C39	Same as C35	
C40	Capacitor, Fixed, Mica, 620 uuf, $\pm 1/2\%$, 500 WVDC	CM111F621D5S
C41 thru C43	Same as C40	
C44	Same as C10	
C45	Same as C11	
C46	Same as C10	
C47	Same as C13	
C48 thru C51	Same as C1	
C52	Same as C10	
C53	Same as C11	
C54	Same as C10	
C55 thru C58	Same as C1	
C59	Same as C10	
C60	Same as C11	
C61	Same as C10	

STEP GENERATOR A A-4478

REF SYMBOL	DESCRIPTION	TMC PART NUMBER
C62 thru C65	Same as C1	
C66	Same as C31	
C67	Same as C13	
C68	Same as C1	
C69	Same as C35	
C70 thru C72	Not Used	
C73 thru C77	Same as C1	
C78	Same as C10	
C79 thru C81	Same as C1	
C82	Same as C6	
C83	Same as C11	
C84	Same as C6	
C85	Same as C13	
C86 thru C89	Same as C1	
C90	Same as C6	
C91	Same as C11	
C92	Same as C6	
C93 thru C96	Same as C1	

STEP GENERATOR A A-4478

REF SYMBOL	DESCRIPTION	TMC PART NUMBER
C97	Same as C6	
C98	Same as C11	
C99	Same as C6	
C100 thru C103	Same as C1	
C104	Capacitor, Fixed, Mica, 68 uuf, $\pm 1\%$, 500 WVDC	CM111E680J5S
C105	Same as C1	
C106	Same as C13	
C107	Same as C6	
C108	Same as C11	
C109	Same as C6	
C110	Same as C13	
C111 thru C114	Same as C1	
C115	Same as C6	
C116	Same as C11	
C117	Same as C6	
C118 thru C121	Same as C1	
C122	Same as C6	
C123	Same as C11	
C124	Same as C6	
C125 thru C127	Same as C1	

STEP GENERATOR A A-4478

REF SYMBOL	DESCRIPTION	TMC PART NUMBER
C128	Same as C104	
C129	Same as C1	
C130	Same as C13	
C131	Same as C1	
C132	Capacitor, Fixed, Ceramic, 100 uuf, GMV, 500 WVDC	CC100-30
C133	Same as C1	
CR1	Semiconductor, Device, Diode	DD139
CR2 thru CR4	Same as CR1	
CR5	Semiconductor, Device, Diode	IN914
CR6 thru CR12	Same as CR5	
L1	Coil, Radio Frequency, Fixed, 120 uh, $\pm 10\%$, molded case	CL275-121
L2 thru L5	Same as L1	
L6	Coil, Radio Frequency, fixed, 2200 uh, $\pm 10\%$, molded case	CL275-222
L7	Same as L6	
L8	Coil, Radio Frequency, fixed, 12 uh, $\pm 10\%$, molded case	CL275-120
L9	Same as L8	
L10 thru L20	Same as L1	
Q1	Transistor	2N3646

STEP GENERATOR A A-4478

REF SYMBOL	DESCRIPTION	TMC PART NUMBER
Q2 thru Q15	Same as Q1	
R1	Resistor, Variable, Composition, 100 ohms, $\pm 30\%$, 0.5 watts	RV124-1-101
R2	Resistor, Fixed, Composition, 8200 ohms, $\pm 5\%$, $\frac{1}{4}$ watt	RC07GF822J
R3	Resistor, Fixed, Composition, 1000 ohms, $\pm 5\%$, $\frac{1}{4}$ watt	RC07GF102J
R4	Resistor, Fixed, Composition, 330 ohms, $\pm 5\%$, $\frac{1}{4}$ watt	RC07GF331J
R5	Resistor, Fixed, Composition, 47 ohms, $\pm 5\%$, $\frac{1}{4}$ watt	RC07GF470J
R6	Resistor, Fixed, Composition, 68 ohms, $\pm 5\%$, $\frac{1}{4}$ watt	RC07GF680J
R7	Resistor, Variable, Composition, 500 ohms, $\pm 30\%$, 0.5 watts	RV124-1-501
R8	Resistor, Fixed, Composition, 100 ohms, $\pm 5\%$, $\frac{1}{4}$ watt	RC07GF101J
R9	Same as R8	
R10	Same as R2	
R11	Same as R3	
R12	Same as R4	
R13	Resistor, Fixed, Composition, 1800 ohms, $\pm 5\%$, $\frac{1}{4}$ watt	RC07GF182J
R14	Resistor, Fixed, Composition, 15 ohms, $\pm 5\%$, $\frac{1}{4}$ watt	RC07GF150J
R15	Resistor, Fixed, Composition, 180 ohms, $\pm 5\%$, $\frac{1}{4}$ watt	RC07GF181J
R16	Same as R2	
R17	Same as R3	
R18	Same as R4	
R19	Same as R13	

STEP GENERATOR A A-4478

REF SYMBOL	DESCRIPTION	TMC PART NUMBER
R20	Resistor, Fixed, Composition, 22 ohms, ±5%, ¼ watt	RC07GF220J
R21	Resistor, Fixed, Composition, 120 ohms, ±5%, ¼ watt	RC07GF121J
R22	Resistor, Fixed, Composition, 12000 ohms, ±5%, ¼ watt	RC07GF123J
R23	Same as R13	
R24	Resistor, Fixed, Composition, 820 ohms, ±5%, ¼ watt	RC07GF821J
R25	Same as R8	
R26	Resistor, Fixed, Composition, 27 ohms, ±5%, ¼ watt	RC07GF270J
R27	Same as R15	
R28	Same as R1	
R29	Same as R4	
R30	Same as R2	
R31	Same as R3	
R32	Same as R6	
R33	Same as R21	
R34	Same as R21	
R35	Same as R2	
R36	Same as R3	
R37	Same as R4	
R38	Same as R13	
R39	Same as R14	
R40	Same as R15	
R41	Same as R2	
R42	Same as R3	

STEP GENERATOR A A-4478

REF SYMBOL	DESCRIPTION	TMC PART NUMBER
R43	Same as R4	
R44	Same as R13	
R45	Same as R20	
R46	Same as R21	
R47	Same as R22	
R48	Same as R13	
R49	Same as R24	
R50	Same as R8	
R51	Same as R26	
R52	Same as R15	
R53	Resistor, Fixed, Composition, 10 ohms, ±5%, ½ watt	RC07GF100J
R54 thru R60	Not used	
R61	Same as R1	
R62	Same as R2	
R63	Same as R3	
R64	Same as R4	
R65	Same as R5	
R66	Same as R6	
R67	Same as R7	
R68	Same as R8	
R69	Same as R8	
R70	Same as R2	
R71	Same as R3	

STEP GENERATOR A A-4478

REF SYMBOL	DESCRIPTION	TMC PART NUMBER
R72	Same as R4	
R73	Same as R13	
R74	Same as R14	
R75	Same as R15	
R76	Same as R2	
R77	Same as R3	
R78	Same as R4	
R79	Same as R13	
R80	Same as R20	
R81	Same as R21	
R82	Same as R22	
R83	Same as R13	
R84	Same as R24	
R85	Same as R8	
R86	Same as R26	
R87	Same as R15	
R88	Same as R2	
R89	Same as R3	
R90	Same as R4	
R91	Same as R13	
R92	Same as R14	
R93	Same as R15	
R94	Same as R2	
R95	Same as R3	

STEP GENERATOR A A-4478

REF SYMBOL	DESCRIPTION	TMC PART NUMBER
R96	Same as R4	
R97	Same as R13	
R98	Same as R20	
R99	Same as R21	
R100	Same as R22	
R101	Same as R13	
R102	Same as R24	
R103	Same as R8	
R104	Same as R26	
R105	Same as R15	
R106 thru R108	Same as R21	
R109 thru R112	Same as R8	
T1	Transformer, Radio Frequency, tuned	TT287-19
T2	Transformer, Radio Frequency, tuned	TT287-5
T3	Transformer, Radio Frequency, tuned	TT287-3
T4	Transformer, Radio Frequency, tuned	TT287-4
T5	Same as T3	
T6	Same as T4	
T7	Same as T3	
T8	Transformer, Radio Frequency, tuned	TT287-20
T9	Transformer, Radio Frequency, fixed	TZ221
T10	Same as T2	

STEP GENERATOR A A-4478

REF SYMBOL	DESCRIPTION	TMC PART NUMBER
T11	Same as T3	
T12	Same as T4	
T13	Same as T3	
T14	Same as T4	
T15	Same as T3	
T16	Same as T8	
T17	Same as T1	
T18	Transformer, Radio Frequency, tuned,	TT287-15
T19	Transformer, Radio Frequency, tuned	TT287-13
T20	Transformer, Radio Frequency, tuned	TT287-14
T21	Same as T19	
T22	Same as T20	
T23	Same as T19	
T24	Same as T8	
T25	Same as T18	
T26	Same as T19	
T27	Same as T20	
T28	Same as T19	
T29	Same as T20	
T30	Same as T19	
T31	Same as T8	

MIXER FINAL A-4479

REF SYMBOL	DESCRIPTION	TMC PART NUMBER
C1	Capacitor, Fixed, Ceramic, 1,000 uuf, GMV, 500 WVDC	CC100-29
C2	Same as C1	
C3	Capacitor, Fixed, Mica, 220 uuf, $\pm 2\%$, 500 WVDC	CM111F221G5S
C4 thru C7	Same as C1	
C8	Capacitor, Fixed, Mica, 1,200 uuf, $\pm 5\%$, 500 WVDC	CM112F122J5S
C9	Not used	
C10	Same as C3	
C11	Capacitor, Fixed, Mica, 5 uuf, $\pm 10\%$, 500 WVDC	CM111C050K5S
C12	Same as C3	
C13	Same as C1	
C14	Same as C1	
C15	Capacitor, Fixed, Mica, 270 uuf, $\pm 1\%$, 500 WVDC	CM111F271F5S
C16	Same as C11	
C17	Same as C3	
C18	Same as C1	
C19	Same as C1	
C20	Same as C3	
C21	Same as C1	
C22	Capacitor, Fixed, Mica, 1,500 uuf, $\pm \frac{1}{2}\%$, 500 WVDC	CM112F152DS
C23	Same as C22	
C24	Capacitor, Fixed, Mica, 130 uuf, $\pm 2\%$, 500 WVDC	CM111F131G5S
C25	Capacitor, Fixed, Mica, 12 uuf, $\pm 5\%$, 500 WVDC	CM111C120J5S
C26	Same as C24	
C27	Same as C1	

MIXER FINAL A-4479

REF SYMBOL	DESCRIPTION	TMC PART NUMBER
C28	Same as C24	
C29	Same as C1	
C30	Same as C24	
C31	Same as C25	
C32	Same as C1	
C33	Same as C1	
C34	Not used	
C35	Same as C1	
C36	Capacitor, Variable, Ceramic, 9 to 35 uuf, 100 WVDC	CV112-2
C37	Capacitor, Fixed, Ceramic, 20000 uuf, +80-20%, 25 WVDC	CC100-40
C38 thru C44	Same as C37	
C45	Capacitor, Fixed, Mica, 200 uuf, ±5%, 500 WVDC	CM111F201J5S
C46	Same as C1	
C47	Same as C1	
C48	Same as C36	
C49 thru C51	Same as C1	
C52	Same as C45	
C53	Same as C25	
C54	Same as C1	
C55	Same as C1	
C56	Same as C11	
C57	Same as C3	

MIXER FINAL A-4479

REF SYMBOL	DESCRIPTION	TMC PART NUMBER
C58 thru C61	Same as C1	
CR1	Semiconductor, Device, Diode	DD139
CR2 thru CR4	Same as CR1	
CR5	Semiconductor Device, Diode	1N4864
CR6	Same as CR5	
CR7	Same as CR5	
L1	Not used	
L2	Coil, Radio Frequency, fixed, 8.2 uh, $\pm 10\%$, molded case	CL275-8.2
L3	Coil, Radio Frequency, fixed, 120 uh, $\pm 10\%$, molded case	CL275-121
L4 thru L12	Same as L3	
Q1	Transistor	2N3646
Q2 thru Q6	Same as Q1	
R1	Resistor, Fixed, Composition, 390 ohms, $\pm 5\%$, $\frac{1}{4}$ watt	RC07GF391J
R2	Resistor, Fixed, Composition, 56 ohms, $\pm 5\%$, $\frac{1}{4}$ watt	RC07GF560J
R3	Resistor, Fixed, Composition, 8200 ohms, $\pm 5\%$, $\frac{1}{4}$ watt	RC07GF822J
R4	Resistor, Fixed, Composition, 2200 ohms, $\pm 5\%$, $\frac{1}{4}$ watt	RC07GF222J
R5	Same as R1	
R6	Resistor, Fixed, Composition, 220 ohms, $\pm 5\%$, $\frac{1}{4}$ watt	RC07GF221J
R7	Resistor, Variable, Composition, 500 ohms, $\pm 30\%$, 0.5 watts	RV124-1-501
R8	Same as R6	

MIXER FINAL A-4479

REF SYMBOL	DESCRIPTION	TMC PART NUMBER
R9	Resistor, Fixed, Composition, 120 ohms, $\pm 5\%$, $\frac{1}{4}$ watt	RC07GF121J
R10	Resistor, Fixed, Composition, 1,800 ohms, $\pm 5\%$, $\frac{1}{4}$ watt	RC07GF182J
R11	Resistor, Fixed, Composition, 10000 ohms, $\pm 5\%$, $\frac{1}{4}$ watt	RC07GF103J
R12	Resistor, Fixed, Composition, 15 ohms, $\pm 5\%$, $\frac{1}{4}$ watt	RC07GF150J
R13	Resistor, Fixed, Composition, 1000 ohms, $\pm 5\%$, $\frac{1}{4}$ watt	RC07GF102J
R14	Resistor, Fixed, Composition, 4700 ohms, $\pm 5\%$, $\frac{1}{4}$ watt	RC07GF472J
R15	Same as R11	
R16	Same as R1	
R17	Resistor, Fixed, Composition, 8.2 ohms, $\pm 5\%$, $\frac{1}{4}$ watt	RC07GF8R2J
R18	Same as R7	
R19	Resistor, Fixed, Composition, 330 ohms, $\pm 5\%$, $\frac{1}{4}$ watt	RC07GF331J
R20	Resistor, Fixed, Composition, 470 ohms, $\pm 5\%$, $\frac{1}{4}$ watt	RC07GF471J
R21	Resistor, Fixed, Composition, 47 ohms, $\pm 5\%$, $\frac{1}{4}$ watt	RC07GF470J
R22	Resistor, Fixed, Composition, 6800 ohms, $\pm 5\%$, $\frac{1}{4}$ watt	RC07GF682J
R23	Resistor, Fixed, Composition, 3300 ohms, $\pm 5\%$, $\frac{1}{4}$ watt	RC07GF332J
R24	Resistor, Fixed, Composition, 12000 ohms, $\pm 5\%$, $\frac{1}{4}$ watt	RC07GF123J
R25	Resistor, Fixed, Composition, 560 ohms, $\pm 5\%$, $\frac{1}{4}$ watt	RC07GF561J
R26	Same as R22	
R27	Resistor, Fixed, Composition, 270 ohms, $\pm 5\%$, $\frac{1}{4}$ watt	RC07GF271J
R28	Same as R22	
R29	Resistor, Fixed, Composition, 33 ohms, $\pm 5\%$, $\frac{1}{4}$ watt	RC07GF330J
R30	Same as R19	
R31	Resistor, Fixed, Composition, 1 meg ohm, $\pm 5\%$, $\frac{1}{4}$ watt	RC07GF105J
R32	Resistor, Fixed, Composition, 47000 ohms, $\pm 5\%$, $\frac{1}{4}$ watt	RC07GF473J
R33	Same as R6	

MIXER FINAL A-4479

REF SYMBOL	DESCRIPTION	TMC PART NUMBER
R34	Same as R31	
R35	Resistor, Fixed, Composition: 680 ohms, $\pm 5\%$, $\frac{1}{4}$ watt	RC07GF681J
R36	Same as R13	
R37	Same as R14	
R38	Same as R19	
R39	Same as R12	
R40	Resistor, Fixed, Composition, 22 ohms, $\pm 5\%$, $\frac{1}{4}$ watt	RC07GF220J
R41	Same as R29	
R42 thru R44	Same as R6	
R45	Same as R27	
R46	Same as R24	
R47	Same as R24	
R48	Resistor, Fixed, Composition, 1200 ohms, $\pm 5\%$, $\frac{1}{4}$ watt	RC07GF122J
R49	Resistor, Fixed, Composition, 180 ohms, $\pm 5\%$, $\frac{1}{4}$ watt	RC07GF181J
T1	Transformer, Radio Frequency, tuned	TT285-4
T2	Transformer, Radio Frequency, tuned	TT285-2
T3	Same as T2	
T4	Same as T2	
T5	Transformer, Radio Frequency, tuned	TT285-6
T6	Same as T2	
T7	Transformer, Radio Frequency, tuned	TT285-3
T8	Same as T1	
T9	Same as T7	
T10	Same as T1	

MIXER FINAL A-4479

REF SYMBOL	DESCRIPTION	TMC PART NUMBER
T11	Transformer, Radio Frequency, tuned	TT285-7
T12	Transformer, Radio Frequency, tuned	TT285-18
T13	Same as T1	

SPECTRUM GENERATOR A-4480

REF SYMBOL	DESCRIPTION	TMC PART NUMBER
C1	Capacitor, Fixed, Ceramic, 20000 uuf, +60-40%, 150 WVDC	CC100-35
C2	Capacitor, Fixed, Mica, 2700 uuf, $\pm\frac{1}{2}\%$, 500 WVDC	CM112F272D5S
C3	Same as C1	
C4	Same as C1	
C5	Capacitor, Fixed, Ceramic, 100 uuf, GMV, 500 WVDC	CC100-30
C6	Capacitor, Fixed, Ceramic, 10000 uuf, GMV, 500 WVDC	CC100-16
C7	Same as C6	
C8	Same as C6	
C9	Capacitor Fixed, Mica, 20 uuf, $\pm 2\%$, 500 WVDC	CM111C200J5S
C10	Same as C6	
C11	Same as C6	
C12	Capacitor, Variable, Ceramic, 9 to 35 uuf, 100 WVDC	CV112-2
C13	Capacitor, Fixed, Ceramic, 1000 uuf, GMV, 500 WVDC	CC100-29
C14	Same as C6	
C15	Capacitor, Fixed, Mica, 320 uuf, $\pm\frac{1}{2}\%$, 500 WVDC	CM11F321D5S
C16 thru C18	Same as C6	
C19	Same as C15	
C20	Same as C6	
C21	Same as C13	
C22	Same as C6	
C23	Not used	
C24 thru C33	Not used	
C34	Same as C6	

SPECTRUM GENERATOR A-4480

REF SYMBOL	DESCRIPTION	TMC PART NUMBER
C35	Same as C13	
C36	Same as C12	
C37	Same as C6	
C38	Same as C6	
C39	Capacitor, Fixed, Mica, 220 uuf, $\pm 2\%$, 500 WVDC	CM111F221G5S
C40	Same as C6	
C41	Same as C13	
C42	Same as C6	
C43	Same as C39	
C44 thru C48	Same as C6	
C49	Same as C13	
C50	Same as C12	
C51	Same as C6	
C52	Same as C6	
C53	Capacitor, Fixed Mica, 270 uuf, $\pm 1\%$, 500 WVDC	CM111F271F5S
C54	Same as C13	
C55	Same as C6	
C56	Same as C12	
C57	Same as C53	
C58 thru C62	Same as C6	
C63	Same as C12	
C64	Same as C12	

SPECTRUM GENERATOR A-4480

REF SYMBOL	DESCRIPTION	TMC PART NUMBER
C65	Same as C6	
C66 thru C68	Capacitor, Fixed, Ceramic, 200,000 uuf, +80-20%, 25 WVDC	CC100-33
C69	Capacitor, Fixed, Mica, 180 uuf, $\pm 2\%$, 500 WVDC	CM11F181G5S
C70	Same as C6	
C71	Same as C6	
C72	Same as C13	
C73	Same as C12	
C74	Same as C6	
C75	Capacitor, Fixed, Mica, 430 uuf, $\pm 2\%$, 500 WVDC	CM11F431G5S
C76	Same as C6	
C77	Same as C6	
C78	Same as C13	
C79	Not used	
C80	Same as C12	
C81	Same as C75	
C82 thru C84	Same as C13	
C85	Capacitor, Fixed, Mica, 82 uuf, $\pm 2\%$, 500 WVDC	CM111E820F5S
C86	Capacitor, Variable, Ceramic, 15-60 uuf, 100 WVDC	CV112-6
C87	Same as C13	
C88	Capacitor, Fixed, Mica, 100 uuf, $\pm 10\%$, 500 WVDC	CM11F101J5S
C89	Same as C86	
C90	Same as C13	

SPECTRUM GENERATOR A-4480

REF SYMBOL	DESCRIPTION	TMC PART NUMBER
CR1	Semiconductor, Device, Diode, Silicon	IN750
Q1 thru Q5	Transistor	2N3646
Q6, Q7	Not used	
Q8 thru Q19	Same as Q1	
R1	Resistor, Fixed, Composition, 330 ohms, 5%, 1/4 watt	RC07GF331J
R2	Resistor, Fixed, Composition, 8200 ohms, 5%, 1/4 watt	RC07GF822J
R3	Resistor, Fixed, Composition, 1000 ohms, 5%, 1/4 watt	RC07GF102J
R4	Resistor, Fixed, Composition, 47 ohms, 5%, 1/4 watt	RC07GF470J
R5	Same as R3	
R6	Resistor, Fixed, Composition, 33000 ohms, 5%, 1/4 watt	RC07GF333J
R7	Same as R3	
R8	Resistor, Fixed, Composition, 10000 ohms, 5%, 1/4 watt	RC07GF103J
R9	Same as R4	
R10	Same as R8	
R11	Resistor, Fixed, Composition, 180 ohms, 5%, 1/4 watt	RC07GF181J
R12	Same as R3	
R13	Resistor, Fixed, Composition, 560 ohms, 5%, 1/4 watt	RC07GF561J
R14	Resistor, Fixed, Composition, 470000 ohms, 5%, 1/4 watt	RC07GF474J
R15	Same as R2	
R16	Same as R3	
R17	Resistor, Fixed, Composition, 15000 ohms, 5%, 1/4 watt	RC07GF153J

SPECTRUM GENERATOR A-4480

REF SYMBOL	DESCRIPTION	TMC PART NUMBER
R18	Resistor, Fixed, Composition, 3300 ohms, 5%, 1/4 watt	RC07GF332J
R19	Resistor, Fixed, Composition, 270 ohms, 5%, 1/4 watt	RC07GF271J
R20 thru R26	Not used	
R27	Same as R14	
R28	Same as R13	
R29	Same as R3	
R30	Same as R2	
R31	Same as R17	
R32	Same as R18	
R33	Same as R19	
R34	Same as R14	
R35	Same as R3	
R36	Same as R2	
R37	Same as R13	
R38	Same as R17	
R39	Same as R18	
R40	Same as R19	
R41	Resistor, Fixed, Composition, 4700 ohms, 5%, 1/4 watt	RC07GF472J
R42	Resistor, Fixed, Composition, 100000 ohms, 5%, 1/4 watt	RC07GF104J
R43	Same as R42	
R44	Same as R8	
R45	Resistor, Fixed, Composition, 2200 ohms, 5%, 1/4 watt	RC07GF222J
R46	Resistor, Fixed, Composition, 3900 ohms, 5%, 1/4 watt	RC07GF392J

SPECTRUM GENERATOR A-4480

REF SYMBOL	DESCRIPTION	TMC PART NUMBER
R47	Same as R45	
R48	Resistor, Fixed, Composition, 180 ohms, $\pm 5\%$, 1 watt	RC32GF181J
R49	Same as R8	
R50	Same as R46	
R51 and R52	Same as R3	
R53	Same as R14	
R54	Same as R13	
R55	Same as R3	
R56	Same as R2	
R57	Same as R17	
R58	Same as R18	
R59	Resistor, Fixed, Composition, 390 ohms, 5%, $\frac{1}{4}$ watt	RC07GF391J
R60	Resistor, Variable, Composition, 5000 ohms, $\pm 30\%$, 5 watts	RV124-1-502
R61	Same as R11	
R62 thru R64	Resistor, Fixed, Composition, 100 ohms, 5%, $\frac{1}{4}$ watt	RC07GF101J
R65	Not used	
R66	Same as R62	
R67	Resistor, Fixed, Composition, 27 ohms, 5%, $\frac{1}{4}$ watt	RC07GF270J
R68	Same as R62	
R69	Same as R8	
R70	Same as R8	

SPECTRUM GENERATOR A-4480

REF SYMBOL	DESCRIPTION	TMC PART NUMBER
R71	Resistor, Fixed, Composition, 2700 ohms, 5%, 1/4watt	RC07GF272J
R72	Same as R41	
R73 thru R75	Same as R4	
T1	Transformer, Radio Frequency, tuned	TT286-2
T2	Transformer, Radio Frequency, tuned	TT286-16
T3	Transformer, Radio Frequency , tuned	TT286-15
T4	Not used	
T6	Same as T2	
T7	Same as T3	
T8	Same as T2	
T9	Same as T3	
T10	Transformer, Radio Frequency, tuned	TT286-14
T11	Transformer, Radio Frequency, tuned	TT286-13
T12	Transformer, Radio Frequency, tuned	TZ222
TP3	Terminal Stud.	TE0-127-2
TP5	Same as TP3	
TP6	Same as TP3	
P8	Same as TP3	
TP9	Same as TP3	
L1 thru L3	Coil, Radio Frequency, Fixed, 120 uh, ±10%	CL275-121
L4,L5	Not used	

SPECTRUM GENERATOR A-4480

REF SYMBOL	DESCRIPTION	TMC PART NUMBER
L6 thru L14	Same as L1	
L15	Coil, Radio Frequency, fixed, 12 uh, $\pm 10\%$	CL275-120
L16	Same as L1	
L17	Same as L1	
L18	Coil, 40 MC	CL419
L19	Same as L1	
Y1	Crystal, Unit, Quartz, 12 MHZ	CR109-124
Y2	Crystal, Unit, Quartz, 14 MHZ	CR109-138
Y3	Crystal, Unit, Quartz, 8.0 MHZ	CR109-104
Y4	Not used	
Y5	Crystal, Unit, Quartz, 13.0 MHZ	CR109-134
Z1	NW Decade Counter	NW135

MIXER DIVIDER ½ BD A-4487

REF SYMBOL	DESCRIPTION	TMC PART NUMBER
C1	Capacitor, Fixed, Ceramic, 100 uuf, GMV, 500 WVDC	CC10029
C2 thru C5	Same as C1	
C6	Capacitor, Fixed, Mica, 220 uuf, ±5%, 500 WVDC	CM111F221J5S
C7	Not used	
C8	Not used	
C9	Capacitor, Fixed, Mica, 1200 uuf, ±1%, 500 WVDC	CM112F122F5S
C10	Same as C6	
C11	Capacitor, Fixed, Mica, 5 uuf, ±5%, 500 WVDC	CM111C050J5S
C12	Same as C6	
C13 thru C16	Same as C1	
C17	Same as C6	
C18	Same as C11	
C19	Same as C6	
C20 thru C23	Same as C1	
C24	Capacitor, Fixed, Mica, 180 uuf, ±2%, 500 WVDC	CM111F181G5S
C25	Capacitor, Fixed, Mica, 1500 uuf, ±1%, 500 WVDC	CM112F152F5S
C26	Same as C25	
C27	Capacitor, Fixed, Mica, 130 uuf, ±5%, 500 WVDC	CM111F131J5S
C28	Capacitor, Fixed, Mica, 12 uuf, ±10%, 500 WVDC	CM111C120K5S
C29 thru C31	Same as C1	

MIXER DIVIDER ½ BD A-4487

REF SYMBOL	DESCRIPTION	TMC PART NUMBER
C32	Same as C27	
C33	Same as C1	
C34	Same as C28	
C35	Same as C27	
C36 thru C40	Same as C1	
C41	Same as C27	
C42 thru C44	Same as C1	
C45	Capacitor, Fixed, Ceramic, 20,000 uuf, +80-20%, 25 WVDC	CC100-40
C46	Same as C1	
C47	Same as C45	
C48	Same as C9	
C49	Not used	
C50	Same as C1	
C51	Same as C1	
C52	Same as C27	
C53	Not used	
C54 thru C57	Same as C1	
CR1	Semiconductor, Device, Diode	DD139
CR2 thru CR4	Same as CR1	
CR5	Semiconductor, Device, Diode	1N752

MIXER DIVIDER ½ BD A-4487

REF SYMBOL	DESCRIPTION	TMC PART NUMBER
L1	Not used	
L2	Coil, Radio Frequency, fixed, 8.2 uh, ±10%, molded case	CL275-8R2
L3	Coil, Radio Frequency, fixed, 120 uh, ±10%, molded case	CL275-121
L4	Coil, Radio Frequency, fixed, 220 uh, ±10%, molded case	CL275-221
L5	Coil, Radio, Frequency, fixed, 15 uh, ±10%, molded case	CL275-150
L6	Same as L3	
Q1	Transistor	2N3646
Q2 thru Q7	Same as Q1	
R1	Resistor, Fixed, Composition, 390 ohms, ±5%, ¼ watt	RC07GF391J
R2	Resistor, Fixed, Composition, 56 ohms, ±5%, ¼watt	RC07GF560J
R3	Resistor, Fixed, Composition, 1500 ohms, ±5%, ¼ watt	RC07GF152J
R4	Resistor, Fixed, Composition, 8200 ohms, ±5%, ¼ watt	RC07GF822J
R5	Resistor, Fixed, Composition, 680 ohms, ±5%, ¼ watt	RC07GF681J
R6	Not used	
R7	Resistor, Variable, Composition, 500 ohms, ±30%, 0.5 watts	RV124-1-501
R8	Resistor, Fixed, Composition, 120 ohms, ±5%, ¼watt	RC07GF121J
R9	Same as R1	
R10	Resistor, Fixed, Composition, 3300 ohms, ±5%, ¼ watt	RC07GF332J

MIXER DIVIDER $\frac{1}{2}$ BD A-4487

REF SYMBOL	DESCRIPTION	TMC PART NUMBER
R11	Resistor, Fixed, Composition, 27000 ohms, $\pm 5\%$, $\frac{1}{4}$ watt	RC07GF273J
R12	Resistor, Fixed, Composition, 1000 ohms, $\pm 5\%$, $\frac{1}{4}$ watt	RC07GF102J
R13	Resistor, Fixed, Composition, 15 ohms, $\pm 5\%$, $\frac{1}{4}$ watt	RC07GF150J
R14	Resistor, Fixed, Composition, 470 ohms, $\pm 5\%$, $\frac{1}{4}$ watt	RC07GF471J
R15	Resistor, Fixed, Composition, 330 ohms, $\pm 5\%$, $\frac{1}{4}$ watt	RC07GF331J
R16	Resistor, Fixed, Composition, 4700 ohms, $\pm 5\%$, $\frac{1}{4}$ watt	RC07GF472J
R17	Resistor, Fixed, Composition, 10000 ohms, $\pm 5\%$, $\frac{1}{4}$ watt	RC07GF103J
R18	Not used	
R19	Same as R5	
R20	Not used	
R21	Not used	
R22	Resistor, Fixed, Composition, 47 ohms, $\pm 5\%$, $\frac{1}{4}$ watt	RC07GF470J
R23	Same as R7	
R24	Resistor, Fixed, Composition, 6800 ohms, $\pm 5\%$, $\frac{1}{4}$ watt	RC07GF682J
R25	Not used	
R26	Same as R10	
R27	Same as R11	
R28	Same as R12	
R29	Same as R13	
R30	Resistor, Fixed, Composition, 560 ohms, $\pm 5\%$, $\frac{1}{4}$ watt	RC07GF561J

MIXER DIVIDER 1/2 BD A-4487

REF SYMBOL	DESCRIPTION	FMC PART NUMBER
R31	Not used	
R32	Same as R24	
R33	Resistor, Fixed, Composition, 270 ohms, ±5%, 1/4 watt	RC07GF271J
R34	Same as R13	
R35	Same as R11	
R36	Same as R10	
R37	Same as R12	
R38	Same as R15	
R39	Same as R30	
R40	Resistor, Fixed, Composition, 220 ohms, ±5%, 1/4 watt	RC07GF221J
R41	Resistor, Fixed, Composition, 100,000 ohms, ±5%, 1/4 watt	RC07GF104J
R42	Same as R41	
R43	Same as R17	
R44	Resistor, Fixed, Composition, 2200 ohms, ±5%, 1/4 watt	RC07GF222J
R45	Resistor, Fixed, Composition, 3900 ohms, ±5%, 1/4 watt	RC07GF392J
R46	Same as R44	
R47	Resistor, Fixed, Composition, 100 ohms, ±5%, 1/4 watt	RC07GF101J
R48	Same as R5	
R49	Same as R13	
R50	Same as R5	

MIXER DIVIDER ½ BD A-4487

REF SYMBOL	DESCRIPTION	TMC PART NUMBER
R51	Same as R15	
R52	Same as R30	
R53	Same as R30	
R54	Same as R12	
R55	Resistor, Fixed, Composition, 18 ohms, ±5%, ¼watt	RC07GF180J
R56	Same as R12	
R57	Same as R12	
T1	Transformer, Radio Frequency, tuned	TT285-4
T2	Transformer, Radio Frequency, tuned	TT285-2
T3 thru T5	Same as T2	
T6	Transformer, Radio Frequency, Tuned	TT285-17
T7	Transformer, Radio Frequency, Tuned	TT285-3
T8	Same as T1	
T9	Same as T7	
T10	Same as T8	
T11	Same as T1	
TP1 thru TP10	Term Stud	TE0127-2
Z1	Network, Frequency Divider	NW134

COMB FILTER A A-4500

REF SYMBOL	DESCRIPTION	TMC PART NUMBER
C1	Capacitor, Fixed, Ceramic, 20,000 uuf, +60-40%, 150 WVDC	CC100-35
C2	Capacitor, Fixed, Mica, 1,800 uuf, ±2%, 500 WVDC	CM112F182G
C3	Capacitor, Fixed, Ceramic, 1,000 uuf, GMV, 500 WVDC	CC100-29
C4	Capacitor, Fixed, Ceramic, 10,000 uuf, GMV, 500 WVDC	CC100-16
C5 thru C7	Same as C1	
C8	Same as C2	
C9	Same as C1	
C10	Capacitor, Variable, Ceramic, 9 to 35 uuf, 100 WVDC	CV112-2
C11	Same as C10	
C12	Same as C1	
C13	Same as C1	
C14	Same as C2	
C15	Same as C1	
C16	Same as C1	
C17	Same as C2	
C18	Same as C1	
C19	Same as C4	
C20	Same as C3	
C21	Same as C4	
C22	Same as C10	
C23	Same as C1	
C24	Same as C1	
C25	Capacitor, Fixed, Mica, 2400 uuf, ±2%, 500 WVDC	CM112F242G5S

COMB FILTER A A-4500

REF SYMBOL	DESCRIPTION	TMC PART NUMBER
C26	Same as C1	
C27	Same as C25	
C28	Same as C1	
C29	Same as C3	
C30	Same as C4	
C31	Same as C4	
C32	Same as C10	
C33	Same as C1	
C34	Same as C1	
C35	Capacitor, Fixed, Mica, 2700 uuf, $\pm 1\%$, 500 WVDC	CM112F272F5S
C36 thru C38	Same as C1	
C39	Same as C3	
C40	Same as C35	
C41	Same as C4	
C42	Same as C4	
C43	Same as C10	
C44	Same as C1	
C45	Same as C1	
C46	Same as C35	
C47	Same as C1	
C48	Same as C1	
C49	Same as C35	
C50	Same as C1	
C51	Same as C3	

COMB FILTER A A-4500

REF SYMBOL	DESCRIPTION	TMC PART NUMBER
C52	Same as C4	
C53	Same as C4	
C54	Same as C10	
C55	Same as C1	
C56	Same as C1	
C57	Capacitor, Fixed, Mica, 3900 uuf, $\pm 2\%$, 300 WVDC	CM112F392G3S
C58	Same as C1	
C59	Same as C1	
C60	Same as C57	
C61	Same as C1	
C62	Same as C3	
C63 thru C65	Same as C4	
C66	Same as C1	
L1	Coil, Radio Frequency, fixed, 120 uh, $\pm 10\%$ molded case	CL275-121
L2 thru L12	Same as L1	
Q1	Transistor	2N3646
Q2 thru Q12	Same as Q1	
R1	Resistor, Fixed, Composition, 15,000 ohms, $\pm 5\%$, $\frac{1}{4}$ watt	RC07GF153J
R2	Resistor, Fixed, Composition, 3,300 ohms, $\pm 5\%$, $\frac{1}{4}$ watt	RC07GF332J
R3	Resistor, Variable, Composition, 500 ohms, $\pm 30\%$, 0.5 watts	RV124-1-501

COMB FILTER A A-4500

REF SYMBOL	DESCRIPTION	TMC PART NUMBER
R4	Resistor, Fixed, Composition: 1,000 ohms, ±5%, ½ watt	RC07GF102J
R5	Resistor, Fixed, Composition, 8,200 ohms, ±5%, ½ watt	RC07GF822J
R6	Resistor, Fixed, Composition, 470000 ohms, ±5%, ½ watt	RC07GF474J
R7	Resistor, Fixed, Composition, 560 ohms, ±5%, ½ watt	RC07GF561J
R8	Same as R7	
R9	Same as R6	
R10	Same as R5	
R11	Same as R4	
R12	Same as R1	
R13	Same as R2	
R14	Same as R3	
R15	Same as R7	
R16	Same as R6	
R17	Same as R5	
R18	Same as R4	
R19	Same as R1	
R20	Same as R2	
R21	Same as R3	
R22	Same as R7	
R23	Same as R6	
R24	Same as R5	
R25	Same as R4	
R26	Same as R1	

COMB FILTER A A-4500

REF SYMBOL	DESCRIPTION	TMC PART NUMBER
R27	Same as R2	
R28	Same as R3	
R29	Same as R7	
R30	Same as R6	
R31	Same as R5	
R32	Same as R4	
R33	Same as R1	
R34	Same as R2	
R35	Same as R3	
R36	Same as R7	
R37	Same as R6	
R38	Same as R5	
R39	Same as R4	
R40	Same as R1	
R41	Same as R2	
R42	Same as R3	
T1	Transformer, Radio Frequency, tuned	TT286-8
T2	Same as T1	
T3	Transformer, Radio Frequency, tuned	TT286-6
T4	Same as T3	
T5	Same as T3	
T6	Same as T3	
T7	Transformer, Radio, Frequency, tuned	TT286-4
T8	Same as T7	
T9	Transformer, Radio, Frequency, tuned	TT286-2

COMB FILTER A A-4500

REF SYMBOL	DESCRIPTION	TMC PART NUMBER
T10	Same as T9	
T11	Same as T9	
T12	Same as T9	
XY1	Socket, Crystal, clip type, 2 cadmium plated contacts, 3/64" X 5/32" tail slots	TS167-1
XY2 thru XY6	Same as XY1	
Y1	Crystal unit quartz, frequency 1.8 MHZ	CR109-100
Y2	Crystal unit quartz, frequency 1.6 MHZ	CR109-98
Y3	Crystal unit quartz, frequency 1.4 MHZ	CR109-96
Y4	Crystal unit quartz, frequency 1.2 MHZ	CR109-94
Y5	Crystal unit quartz, frequency 1.0 MHZ	CR109-92
Y6	Crystal unit quartz, frequency .8 MHZ	CR109-90

COMB FILTER B A-4501

REF SYMBOL	DESCRIPTION	TMC PART NUMBER
C1	Capacitor, Fixed, Ceramic, 20000 uuf, +60-40%, 150 WVDC	CC100-35
C2	Capacitor, Fixed, Mica, 1,600 uuf, ±2%, 500 WVDC	CM112F162G5S
C3	Capacitor, Fixed, Ceramic, 1,000 uuf, GMV, 500 WVDC	CC100-29
C4	Capacitor, Fixed, Ceramic, 10000 uuf, GMV, 500 WVDC	CC100-16
C5 thru C7	Same as C1	
C8	Same as C2	
C9	Same as C1	
C10	Capacitor, Variable, Ceramic, 9 to 35 uuf, 100 WVDC	CV112-2
C11	Same as C10	
C12	Same as C1	
C13	Same as C1	
C14	Capacitor, Fixed, Mica, 2000 uuf, ±2%, 500 WVDC	CM112F202G5S
C15	Same as C1	
C16	Same as C1	
C17	Same as C14	
C18	Same as C1	
C19	Same as C4	
C20	Same as C3	
C21	Same as C4	
C22	Same as C10	
C23	Same as C1	
C24	Same as C1	
C25	Capacitor, Fixed, Mica, 2200 uuf, ±1%, 500 WVDC	CM112F222F5S

COMB FILTER B A-4501

REF SYMBOL	DESCRIPTION	TMC PART NUMBER
C26	Same as C1	
C27	Same as C25	
C28	Same as C1	
C29	Same as C3	
C30	Same as C4	
C31	Same as C4	
C32	Same as C10	
C33	Same as C1	
C34	Same as C1	
C35	Same as C25	
C36 thru C38	Same as C1	
C39	Same as C3	
C40	Same as C25	
C41	Same as C4	
C42	Same as C4	
C43	Same as C10	
C44	Same as C1	
C45	Same as C1	
C46	Capacitor, Fixed, Ceramic, 3300 uuf, ±2%, 500 WVDC	CM112332F5S
C47	Same as C1	
C48	Same as C1	
C49	Same as C46	
C50	Same as C1	
C51	Same as C3	

COMB FILTER B A-4501

REF SYMBOL	DESCRIPTION	TMC PART NUMBER
C52	Same as C4	
C53	Same as C4	
C54	Same as C10	
C55	Same as C1	
C56	Same as C1	
C57	Same as C46	
C58	Same as C1	
C59	Same as C1	
C60	Same as C46	
C61	Same as C1	
C62	Same as C3	
C63 thru C65	Same as C4	
C66	Same as C1	
L1	Coil, Radio Frequency, fixed, 120 uh, ±10%, molded case	CL275-121
L2 thru L12	Same as L1	
Q1	Transistor	
Q2 thru Q12	Same as Q1	
R1	Resistor, Fixed Composition, 15000 ohms, ±5%, ¼ watt	RC07GF153J
R2	Resistor, Fixed Composition, 3300 ohms, ±5%, ¼ watt	RC07GF332J
R3	Resistor, Variable Composition, 500 ohms, ±30%, 0.5 watts	RV124-1-501
R4	Resistor, Fixed, Composition, 1,000 ohms, ±5%, ¼ watt	RC07GF102J

COMB FILTER B A-4501

REF SYMBOL	DESCRIPTION	TMC PART NUMBER
R5	Resistor, Fixed, Composition, 8200 ohms, $\pm 5\%$, $\frac{1}{4}$ watt	RC07GF822J
R6	Resistor, Fixed, Composition, 470000 ohms, $\pm 5\%$, $\frac{1}{4}$ watt	RC07GF474J
R7	Resistor, Fixed, Composition, 560 ohms, $\pm 5\%$, $\frac{1}{4}$ watt	RC07GF561J
R8	Same as R7	
R9	Same as R6	
R10	Same as R5	
R11	Same as R4	
R12	Same as R1	
R13	Same as R2	
R14	Same as R3	
R15	Same as R7	
R16	Same as R6	
R17	Same as R5	
R18	Same as R4	
R19	Same as R1	
R20	Same as R2	
R21	Same as R3	
R22	Same as R7	
R23	Same as R6	
R24	Same as R5	
R25	Same as R4	
R26	Same as R1	
R27	Same as R2	
R28	Same as R3	

COMB FILTER B A-4501

REF SYMBOL	DESCRIPTION	TMC PART NUMBER
R29	Same as R7	
R30	Same as R6	
R31	Same as R5	
R32	Same as R4	
R33	Same as R1	
R34	Same as R2	
R35	Same as R3	
R36	Same as R7	
R37	Same as R6	
R38	Same as R5	
R39	Same as R4	
R40	Same as R1	
R41	Same as R2	
R42	Same as R3	
T1	Transformer, Radio Frequency, tuned,	TT286-8
T2	Same as T1	
T3	Same as T1	
T4	Same as T1	
T5	Transformer, Radio Frequency, tuned	TT286-6
T6	Same as T5	
T7	Transformer, Radio Frequency, tuned	TT286-4
T8	Same as T7	
T9	Same as T7	
T10	Same as T7	
T11	Transformer, Radio Frequency, tuned	TT286-1

COMB FILTER B A-4501

REF SYMBOL	DESCRIPTION	TMC PART NUMBER
T12	Same as T11	
XY1	Socket, Crystal,	TS167-1
XY2 thru XY6	Same as XY1	
Y1	Crystal, unit quartz, frequency 1.9 MHZ	CR109-101
Y2	Crystal, unit quartz, frequency 1.7 MHZ	CR109-99
Y3	Crystal, unit quartz, frequency 1.5 MHZ	CR109-97
Y4	Crystal, unit quartz, frequency 1.3 MHZ	CR109-95
Y5	Crystal, unit quartz, frequency 1.1 MHZ	CR109-93
Y6	Crystal, unit quartz, frequency .8 MHZ	CR109-91

RF OUTPUT A-4502

REF SYMBOL	DESCRIPTION	TMC PART NUMBER
C1	Capacitor, Fixed, Plastic: 0.82 uf, ±5%, 60 WVDC	CN114R82-5J
C2	Capacitor, Fixed, Ceramic: 10,000 uuf, GMV, 500 WVDC	CC100-16
C3	Same as C2	
C4	Same as C1	
C5 Thru C17	Same as C2	
C18	Capacitor, Fixed, Mica: 620 uuf, ±½%, 500 WVDC 500 WVDC	CM111F621D5S
C19	Capacitor, Fixed, Electrolytic: 50 uf, -10+150% at 120 cps at 25 degrees C; 50 WVDC; polarized.	CE105-50-50
C20	Same as C2	
C21 thru C30	Not used	
C31 thru C34	Same as C2	
C35	Capacitor, Fixed, Ceramic: 1,000 uuf, GMV, 500 WVDC	CC100-29
C36	Same as C2	
C37	Same as C35	
C38	Same as C2	
CR1	Semiconductor Device, Diode	IN4864
CR2	Semiconductor Device, Diode.	IN100
CR3	Same as CR2	
L1	Coil, Radio Frequency: 120 uh, ±10%, molded case.	CL240-120
L2 thru L8	Same as L1	

004692044

RF OUTPUT A-4502

REF SYMBOL	DESCRIPTION	MIL PART NUMBER
C1	Capacitor, Fixed, Plastic: 0.82 uf, ±5%, 60 WVDC	CN114R82-5J
C2	Capacitor, Fixed, Ceramic: 10,000 uuf, GMV, 500 WVDC	CC100-16
C3	Same as C2	
C4	Same as C1	
C5 Thru C17	Same as C2	
C18	Capacitor, Fixed, Mica: 620 uuf, ±½%, 500 WVDC 500 WVDC	CM111F621D55
C19	Capacitor, Fixed, Electrolytic: 50 uf, -10+150% at 120 cps at 25 degrees C; 50 WVDC; polarized.	CE105-50-50
C20	Capacitor, Fixed, Mica, 2200 uuf, ±2%, 500 WVDC	CM112F222G55
C21 thru C30	Not used	
C31 thru C34	Same as C2	
C35	Capacitor, Fixed, Ceramic: 1,000 uuf, GMV, 500 WVDC	CC100-19
C36	Same as C2	
C37	Same as C35	
C38	Same as C2	
C39	Capacitor, Fixed, Mica, 1100 uuf, ±½%, 500 WVDC	CM112F112D55
CR1	Semiconductor Device, Diode	IN4864
CR2	Semiconductor Device, Diode	IN100
CR3	Same as CR2	
L1	Coil, Radio Frequency: 120 uh, ±10%, molded case.	CL240-120

RF OUTPUT A-4502

REF SYMBOL	DESCRIPTION	TMC PART NUMBER
L2 thru L6	Same as L1	
L7	Coil, Radio Frequency, 2.20 uh, ±20%, molded case	CL240-2R2
L8	Same as L1	
L9 thru L12	Not Used	
L13	Coil, Radio Frequency: fixed, 120 uh, ±10%, molded case	CL275-121
L14 thru L22	Same as L13	
L23	Coil, Radio Frequency: fixed, 212 uh, ±10%, molded case	CL275-2R2
Q1	Transistor	2N5070
Q2	Transistor	2N3375
Q3	Transistor	2N3296
R1	Resistor, Variable, Composition: 10,000 ohms, ±30%, 0.5 watts	RV124-1-103
R2	Same as R1	
R3	Resistor, Fixed, Composition: 22 ohms, ±5%, ½ watt	RC20GF220J
R4	Resistor, Fixed, Composition: 2,000 ohms, ±30%, ½ watt	RV124-1-202
R5	Resistor, Fixed, Composition: 5600 ohms, ±5%, ½ watt	RC20GF562J
R6	Resistor, Fixed, Composition: 3300 ohms, ±5%, ½ watt	RC20GF332J
R7	Resistor, Fixed, Composition: 1000 ohms, ±5%, 1 watt	RC32GF102J
R8	Same as R3	

RF OUTPUT A-4502

REF SYMBOL	DESCRIPTION	TMC PART NUMBER
R9	Resistor, Fixed, Composition: 1000 ohms, $\pm 5\%$, $\frac{1}{2}$ watt	RC20GF102J
R10	Not Used	
R11	Resistor, Fixed, Composition: 47 ohms, $\pm 5\%$, $\frac{1}{4}$ watt	RC07GF470J
R12	Same as R9	
R13	Resistor, Fixed, Composition: 10 ohms, $\pm 5\%$, $\frac{1}{2}$ watt	RC20GF100J
R14	Same as R10	
R15	Resistor, Fixed, Composition: 2200 ohms, $\pm 5\%$, $\frac{1}{2}$ watt	RC20GF222J
R16	Not used	
R17	Same as R9	
R18	Resistor, Fixed, Composition: 220 ohms, $\pm 5\%$, $\frac{1}{2}$ watt	RC20GF221J
R19	Resistor, Fixed, Composition: 47000 ohms, $\pm 5\%$, $\frac{1}{2}$ watt	RC20GF473J
R20	Not used	
R21	Resistor, Fixed, Composition: 43,000 ohms, $\pm 5\%$, $\frac{1}{2}$ watt	RC20GF433J
T1	Transformer, Radio Frequency: fixed,	TZ220
T2	Transformer, Radio Frequency: fixed,	TZ219

STEP GENERATOR B A-4504

REF SYMBOL	DESCRIPTION	TMC PART NUMBER
C34	Same as C13	
C35	Same as C2	
C36	Same as C11	
C37 thru C40	Same as C2	
C41	Same as C3	
C42	Same as C11	
C43	Same as C2	
C44	Same as C2	
C45	Capacitor, Variable, Ceramic, 9 to 35 uuf, 100 WVDC	CV112-2
C46 thru C48	Same as C2	
C49	Same as C45	
C50 thru C52	Same as C2	
C53	Same as C11	
C54	Same as C2	
C55	Same as C13	
C56	Same as C2	
C57	Same as C11	
C58 thru C61	Same as C2	
C62	Same as C45	
C63 thru C66	Same as C11	

STEP GENERATOR B A-4504

REF SYMBOL	DESCRIPTION	TMC PART NUMBER
C67	Capacitor, Fixed, Mica, 82 uuf, $\pm 5\%$, 500 WVDC	CM111F820J5S
C68	Same as C1	
FL1	Filter, Bandpass	FX280
FL2	Filter, Bandpass	FX281
FL3	Filter, Bandpass	FX282
L1	Coil, Radio Frequency, fixed, 120 uh, $\pm 10\%$, molded case	CL275-121
L2	Same as L1	
L3	Same as L1	
L4	Coil, Radio Frequency, fixed, 47 uh, $\pm 10\%$, molded case	CL275-470
L5	Same as L1	
L6	Coil, Radio Frequency, fixed, 10 uh, $\pm 10\%$, molded case	CL275-100
L7 thru L10	Same as L1	
L11	Same as L4	
L12	Same as L1	
L13	Same as L6	
L14 thru L17	Same as L1	
L18	Same as L4	
L19	Same as L1	
L20	Same as L6	
L21	Same as L1	
L22	Coil, Radio Frequency, fixed, 0.47 uh, $\pm 10\%$, molded case	CL275-OR47

STEP GENERATOR B A-4504

REF SYMBOL	DESCRIPTION	TMC PART NUMBER
Q1	Transistor	2N3646
Q2 thru Q9	Same as Q1	
R1	Resistor, Fixed, Composition, 68 ohms, $\pm 5\%$, $\frac{1}{4}$ watt	RC07GF680J
R2	Resistor, Fixed, Composition, 3,900 ohms, $\pm 5\%$, $\frac{1}{4}$ watt	RC07GF392J
R3	Resistor, Fixed, Composition, 39000 ohms, $\pm 5\%$, $\frac{1}{4}$ watt	RC07GF393J
R4	Resistor, Fixed, Composition, 5600 ohms, $\pm 5\%$, $\frac{1}{4}$ watt	RC07GF562J
R5	Resistor, Fixed, Composition, 330 ohms, $\pm 5\%$, $\frac{1}{4}$ watt	RC07GF331J
R6	Resistor, Fixed, Composition, 8200 ohms, $\pm 5\%$, $\frac{1}{4}$ watt	RC07GF822J
R7	Resistor, Fixed, Composition, 1000 ohms, $\pm 5\%$, $\frac{1}{4}$ watt	RC07GF102J
R8	Resistor, Fixed, Composition, 150 ohms, $\pm 5\%$, $\frac{1}{4}$ watt	RC07GF151J
R9	Resistor, Fixed, Composition, 10 ohms, $\pm 5\%$, $\frac{1}{4}$ watt	RC07GF100J
R10	Resistor, Fixed, Composition, 47 ohms, $\pm 5\%$, $\frac{1}{4}$ watt	RC07GF470J
R11	Same as R7	
R12	Same as R6	
R13	Same as R8	
R14	Same as R9	
R15	Same as R5	
R16	Same as R1	
R17	Same as R2	
R18	Same as R3	
R19	Same as R4	
R20	Same as R5	
R21	Same as R6	
R22	Same as R7	

STEP GENERATOR B A-4504

REF SYMBOL	DESCRIPTION	TMC PART NUMBER
R23	Same as R8	
R24	Same as R9	
R25	Same as R10	
R26	Same as R7	
R27	Same as R6	
R28	Same as R8	
R29	Same as R9	
R30	Same as R5	
R31	Same as R1	
R32	Same as R2	
R33	Same as R3	
R34	Same as R4	
R35	Same as R5	
R36	Same as R6	
R37	Same as R7	
R38	Same as R8	
R39	Same as R9	
R40	Same as R10	
R41	Same as R7	
R42	Same as R6	
R43	Same as R8	
R44	Same as R9	
R45	Same as R5	
R46 thru R48	Same as R10	

STEP GENERATOR B A-4504

REF SYMBOL	DESCRIPTION	TMC PART NUMBER
<p>T1</p> <p>T2 thru T9</p>	<p>Transformer, Radio Frequency, fixed,</p> <p>Same as T1</p>	<p>TX215-12</p>

TRANSLATOR A-4505

REF SYMBOL	DESCRIPTION	TMC PART NUMBER
C1	Capacitor, Fixed, Ceramic, 1000 uuf, GMV, 500 WVDC	CC100-29
C2	Capacitor, Fixed, Mica, 18 uuf, ±5%, 500 WVDC	CM111C180J5S
C3	Same as C1	
C4	Capacitor, Fixed, Ceramic, 100000 uuf, +80-20%, 100 WVDC	CC100-28
C5 thru C7	Same as C1	
C8	Same as C4	
C9	Same as C2	
C10	Capacitor, Fixed, Mica, 22 uuf, ±5%, 500 WVDC	CM111C220J5S
C11 thru C13	Same as C1	
C14	Same as C2	
C15	Capacitor, Fixed, Ceramic, 200000 uuf, =80-20%, 25 WVDC	CC100-33
C16 thru C37	See Separate Parts List A-4600	
C38	Capacitor, Fixed, Ceramic, 100 uuf, GMV, 500 WVDC	CC100-30
C39	Capacitor, Fixed, Mica, 51 uuf, ±2%, 500 WVDC	CM111E510G5S
C40	Not used	
C41	Not used	
C42	Capacitor, Variable, Ceramic, 2 to 8 uuf, 200 WVDC	CV112-4
C43	Capacitor, Fixed, Mica, 47 uuf, ±2%, 500 WVDC	CM111E470G5S
C44	Same as C38	
C45	Same as C39	

TRANSLATOR A-4505

REF SYMBOL	DESCRIPTION	TMC PART NUMBER
C46	Same as C38	
C47	Same as C43	
C48	Same as C42	
C49	Same as C38	
C50	Same as C1	
C51	Same as C39	
C52	Same as C38	
C53	Same as C43	
C54	Same as C42	
C55	Same as C38	
C56	Same as C38	
C56	Same as C38	
C57	Same as C39	
C58	Same as C38	
C59	Capacitor, Fixed, Mica, 75 uuf, $\pm 5\%$, 500 WVDC	CM111E750J5S
C60	Capacitor, Variable, Ceramic, 9 to 35 uuf, 100 WVDC	CV112-2
C61	Same as C38	
C62	Same as C38	
C63	Same as C10	
C64	Capacitor, Fixed, Mica, 68 uuf, $\pm 1\%$, 500 WVDC	CM111E680F5S
C65	Capacitor, Fixed, Mica, 33 uuf, $\pm 2\%$, 500 WVDC	CM111E330G5S
C66	Capacitor, Fixed, Ceramic, 20000 uuf, +80-20%, 25 WVDC	CC100-40
C67	Same as C15	

TRANSLATOR A-4505

REF SYMBOL	DESCRIPTION	TMC PART NUMBER
C68	Capacitor, Fixed, Ceramic, 2200 uuf, GMV, 500 WVDC	CC100-11
C69	Same as C66	
C70	Same as C66	
C71	Same as C4	
C72	Capacitor, Fixed, Mica, 510 uuf, $\pm 2\%$, 500 WVDC	CM111F511G5S
C73	Capacitor, Fixed, Mica, 120 uuf, $\pm 2\%$, 500 WVDC	CM111F121G5S
C74	Capacitor, Fixed, Mica, 560 uuf, $\pm 1\%$, 500 WVDC	CM111F561F5S
C75	Capacitor, Fixed, Mica, 430 uuf, $\pm 2\%$, 500 WVDC	CM111F431G5S
C76	Capacitor, Fixed, Mica, 360 uuf, $\pm 2\%$, 500 WVDC	CM111F361G5S
C77	Same as C4	
C78 thru C80	Same as C1	
C81	Capacitor, Fixed, Mica, 130 uuf, $\pm 2\%$, 500 WVDC	CM111F131G5S
C82	Same as C1	
C83	Capacitor, Fixed, Mica, 390 uuf, $\pm 1\%$, 500 WVDC	CM111F391F5S
C84	Same as C66	
C85	Capacitor, Fixed, Mica, 750 uuf, $\pm 20\%$, 500 WVDC	CM111F751G5S
C86	Same as C83	
C87	Capacitor, Fixed, Mica, 110 uuf, $\pm 5\%$, 500 WVDC	CM111F111J5S
C88	Capacitor, Fixed, Mica, 5 uuf, $\pm 10\%$, 500 WVDC	CM111C050K5S
C89	Same as C87	
C90	Same as C1	
C91	Same as C1	
C92	Same as C87	

TRANSLATOR A-4505

REF SYMBOL	DESCRIPTION	TMC PART NUMBER
C93	Same as C87	
C94	Same as C88	
C95	Same as C1	
C96	Same as C1	
C97	Same as C87	
C98	Same as C87	
C99	Same as C88	
C100	Same as C87	
C101 thru C106	Same as C1	
C107	Same as C87	
C108	Same as C87	
C109	Same as C88	
C110 thru C113	Same as C1	
C114	Same as C87	
C115	Same as C1	
C116	Same as C1	
C117	Same as C38	
C118	Capacitor, Fixed, Electrolytic, 10 MF, -10+150%, 250 WVDC	CE105-10-25
C119	Sam as C38	
CR1	See Seperate Parts List A-4600	
CR2	See Seperate Parts List A-4600	

004692044

TRANSLATOR A-4505

REF SYMBOL	DESCRIPTION	TMC PART NUMBER
CR3	Semiconductor, Device, Diode	DD137
CR4	Semiconductor, Device, Diode	DD138
CR5	Same as CR4	
CR6	Semiconductor, Device, Diode	IN914
CR7	Same as CR6	
CR8	Semiconductor, Device, Diode	IN4864
CR9	Same as CR8	
CR10	Same as CR6	
L1	Coil, Radio Frequency, fixed, 8.2 uh, $\pm 10\%$, molded case	CL275-8R2
L2	Same as L1	
L3	Same as L1	
L4 thru L9	See Separate Parts List A-4600	
L10	Coil, Radio Frequency, fixed, 1.0 uh, $\pm 10\%$, Molded case	CL275-1R0
L11 thru L13	Same as L10	
L14	Coil, Radio Frequency, fixed, .077 uh, $\pm 4\%$	CL412-23
L15	Coil, Radio Frequency, fixed, 22 uh, $\pm 10\%$, molded case	CL275-220
L16	Same as L10	
L17	Coil, Radio Frequency, fixed, 0.39 uh, $\pm 10\%$, molded	CL2750R39
L18	Same as L10	
L19	Coil, Radio Frequency, fixed, 0.82 uh, $\pm 10\%$, molded case	CL275-0R82

TRANSLATOR A-4505

REF SYMBOL	DESCRIPTION	TMC PART NUMBER
L20	Coil, Radio Frequency, fixed, 120 uh, $\pm 10\%$, molded case	CL275-121
L21	Same as L20	
L22	Same as L20	
L23	Coil, Radio Frequency, fixed, .63 uh, $\pm 4\%$	CL412-24
L24	Coil, Radio Frequency, fixed, .36 uh, $\pm 4\%$	CL412-25
L25	Same as L20	
L26	Same as L20	
L27	Same as L1	
L28	Same as L1	
L29	Same as L15	
L30	Same as L15	
L131 thru L34	Same as L20	
Q1	Transistor	2N3646
Q2	Same as Q1	
Q3	Same as Q1	
Q4 thru Q6	See Separate Parts List A-4600	
Q7	Transistor	2N3600
Q8 thru Q11	Same as Q7	
Q12 thru Q19	Same as Q1	

TRANSLATOR A-4505

REF SYMBOL	DESCRIPTION	IMP PART NUMBER
R1	Resistor, Fixed, Composition, 47 ohms, ±5%, ¼ watt	RC07GF470J
R2	Resistor, Fixed, Composition, 47000 ohms, ±5%, ¼ watt	RC07GF473J
R3	Resistor, Fixed, Composition, 100000 ohms, ±5%, ¼ watt	RC07GF104J
R4	Resistor, Fixed, Composition, 33 ohms, ±5%, ¼ watt	RC07GF330J
R5	Resistor, Fixed, Composition, 100 ohms, ±5%, ¼ watt	RC07GF101J
R6	Same as R1	
R7	Resistor, Fixed, Composition, 1000 ohms, ±5%, ¼ watt	RC07GF102J
R8	Same as R2	
R9	Same as R4	
R10	Same as R3	
R11	Same as R5	
R12	Same as R1	
R13	Same as R7	
R14	Same as R2	
R15	Same as R4	
R16	Same as R3	
R17	Same as R5	
R18	Same as R7	
R19 thru R36	See Separate Parts List A-4600	
R37	Resistor, Fixed, Composition, 8200 ohms, ±5%, ¼ watt	RC07GF822J
R38	Same as R7	

TRANSLATOR A-4505

REF SYMBOL	DESCRIPTION	TMC PART NUMBER
R39	Same as R5	
R40	See Separate Parts List A-4600	
R41	Resistor, Fixed, Composition, 39 ohms, $\pm 5\%$, $\frac{1}{4}$ watt	RC07GF390J
R42	Resistor, Fixed, Composition, 560 ohms, $\pm 5\%$, $\frac{1}{4}$ watt	RC07GF561J
R43	Same as R7	
R44	Resistor, Fixed, Composition, 150 ohms, $\pm 5\%$, $\frac{1}{4}$ watt	RC07GF151J
R45	Same as R41	
R46	Resistor, Fixed, Composition, 6800 ohms, $\pm 5\%$, $\frac{1}{4}$ watt	RC07GF682J
R47	Resistor, Fixed, Composition, 330 ohms, $\pm 5\%$, $\frac{1}{4}$ watt	RC07GF331J
R48	Resistor, Fixed, Composition, 5600 ohms, $\pm 5\%$, $\frac{1}{4}$ watt	RC07GF562J
R59	Same as R7	
R50	Same as R44	
R51	Same as R41	
R52	Resistor, Fixed, Composition, 220 ohms, $\pm 5\%$, $\frac{1}{4}$ watt	RC07GF221J
R53	Resistor, Fixed, Composition, 4700 ohms, $\pm 5\%$, $\frac{1}{4}$ watt	RC07GF472J
R54	Same as R7	
R55	Same as R44	
R56	Same as R41	
R57	Resistor, Fixed, Composition, 120 ohms, $\pm 5\%$, $\frac{1}{4}$ watt	RC07GF121J
R58	Same as R1	
R59	Same as R1	
R60	Resistor, Fixed, Composition, 3300 ohms, $\pm 5\%$, $\frac{1}{4}$ watt	RC07GF332J
R61	Same as R37	

TRANSLATOR A-4505

REF SYMBOL	DESCRIPTION	TMC PART NUMBER
R62	Same as R44	
R63	Resistor, Fixed, Composition, 8.2 ohms, $\pm 5\%$, $\frac{1}{4}$ watt	RC07GF8R2J
R64	Same as R1	
R65	Same as R1	
R66	Same as R2	
R67	Same as R3	
R68	Same as R7	
R69	Resistor, Fixed, Composition, 10 ohms, $\pm 5\%$, $\frac{1}{4}$ watt	RC07GF100J
R70	Not used	
R71	Resistor, Variable, Composition, 500 ohms, $\pm 30\%$, 0.5 watts	RV124-1-501
R72	Same as R57	
R73	Same as R52	
R74	Resistor, Fixed, Composition, 390 ohms, $\pm 5\%$, $\frac{1}{4}$ watt	RC07GF391J
R75	Same as R52	
R76	Resistor, Fixed, Composition, 18000 ohms, $\pm 5\%$, $\frac{1}{4}$ watt	RC07GF183J
R77	Same as R7	
R78	Resistor, Fixed, Composition, 27000 ohms, $\pm 5\%$, $\frac{1}{4}$ watt	RC07GF273J
R79	Resistor, Fixed, Composition, 22 ohms, $\pm 5\%$, $\frac{1}{4}$ watt	RC07GF220J
R80	Same as R3	
R81	Same as R1	
R82	Same as R7	
R83	Same as R74	

TRANSLATOR A-4505

REF SYMBOL	DESCRIPTION	TMC PART NUMBER
R84	Same as R76	
R85	Resistor, Fixed, Composition, 56000 ohms, ±5%, ¼ watt	RC07GF563J
R86	Resistor, Fixed, Composition, 10000 ohms, ±5%, ¼ watt	RC07GF103J
R87	Same as R2	
R88	Same as R1	
R89	Resistor, Fixed, Composition, 820 ohms, ±5%, ¼watt	RC07GF821J
R90	Resistor, Fixed, Composition, 68000 ohms, ±5%, ¼ watt	RC07GF683J
R91	Resistor, Fixed, Composition, 820000 ohms, ±5%, ¼ watt	RC07GF824J
R92	Resistor, Fixed, Composition, 330000 ohms, ±5%, ¼ watt	RC07GF334J
R93	Resistor, Fixed, Composition, 220000 ohms, ±5%, ¼ watt	RC07GF224J
R94	Same as R74	
R95	Same as R86	
R96	Same as R53	
R97	Resistor, Fixed, Composition, 470 ohms, ±5%, ¼ watt	RC07GF471J
R98	Same as R76	
R99	Same as R3	
R100	Same as R79	
R101	Same as R78	
R102	Same as R7	
R103	Same as R1	
R104	Same as R74	

004692044

TRANSLATOR A-4505

REF SYMBOL	DESCRIPTION	TMC PART NUMBER
R105	Same as R76	
R106	Same as R85	
R107	Same as R86	
R108	Same as R2	
R109	Same as R1	
R110	Same as R89	
R111	Same as R90	
R112	Same as R1	
R113	Same as R1	
R114	Same as R57	
R115 thru R117	See Separate Parts List A-4600	
R118	Same as R1	
R119	Same as R52	
R120	Resistor, Fixed, Composition, 82 ohms, $\pm 5\%$, $\frac{1}{4}$ watt	RC07GF820J
T1	Transformer, Radio Frequency, tuned	TT285-10
T2	Same as T1	
T3	Same as R1	
T4 thru T7	See Separate Parts List A-4600	
T8	Transformer, Radio Frequency, fixed	TZ215-1
T9	Same as T8	
T10	Same as T8	
T11	Transformer, Radio Frequency, fixed,	TZ220

TRANSLATOR A-4505

REF SYMBOL	DESCRIPTION	TMC PART NUMBER
T12	Transformer, Radio Frequency, Tuned	TT285-4
T13	Transformer, Radio Frequency, tuned	TT285-2
T14	Transformer, Pulse	TF228U13
T15 thru T23	Same as T13	

STEP GENERATOR C A-4506

REF SYMBOL	DESCRIPTION	TMC PART NUMBER
C1	Capacitor, Fixed, Mica, 100 uuf, $\pm 1\%$, 500 WVDC	CM111F101F5S
C2	Capacitor, Fixed, Ceramic, 1000 uuf, GMV, 500 WVDC	CC100-29
C3	Capacitor, Fixed, Mica, 18 uuf, $\pm 5\%$, 500 WVDC	CM111C180J5S
C4	Capacitor, Fixed, Mica, 130 uuf, $\pm 5\%$, 500 WVDC	CM111F131J5S
C5	Capacitor, Fixed, Mica, 27 uuf, $\pm 5\%$, 500 WVDC	CM111E270J5S
C6	Capacitor, Fixed, Mica, 91 uuf, $\pm 5\%$, 500 WVDC	CM111F910J5S
C7	Capacitor, Fixed, Ceramic, 100 uuf, GMV, 500 WVDC	CC100-30
C8	Same as C7	
C9	Same as C7	
C10	Capacitor, Variable, Ceramic, 2.5 to 11 uuf, 200 WVDC	CV112-3
C11	Same as C7	
C12	Capacitor, Fixed, Mica, 36 uuf, $\pm 5\%$, 500 WVDC	CM111E360J5S
C13 thru C15	Same as C7	
C16	Same as C10	
C17 thru C21	Same as C7	
C22	Same as C10	
C23 thru C26	Same as C7	
C27	Capacitor, Fixed, Mica, 10 uuf, $\pm 5\%$, 500 WVDC	CM111C100J5S
C28	Capacitor, Variable, Ceramic, 5.5 to 18 uuf 200 WVDC	CV112-1
C29	Same as C7	

STEP GENERATOR C A-4506

REF SYMBOL	DESCRIPTION	TMC PART NUMBER
C30	Same as C2	
C31	Capacitor, Fixed, Mica, 82 uuf, $\pm 1\%$, 500 WVDC	CM111E820F5S
C32	Same as C27	
C33	Capacitor, Fixed, Mica, 110 uuf, $\pm 5\%$, 500 WVDC	CM111F111J5S
C34	Same as C5	
C35	Capacitor, Fixed, Mica, 75 uuf, $\pm 5\%$, 500 WVDC	CM111E750J5S
C36 thru C38	Same as C7	
C39	Same as C10	
C40	Same as C7	
C41	Same as C12	
C42 thru C44	Same as C7	
C45	Same as C10	
C46 thru C50	Same as C7	
C51	Same as C10	
C52 thru C54	Same as C7	
C55	Same as C27	
C56	Same as C28	
C57	Same as C7	
C58	Same as C7	
C59	Same as C2	

STEP GENERATOR C A-4506

REF SYMBOL	DESCRIPTION	TMC PART NUMBER
C60	Same as C31	
C61	Same as C27	
C62	Same as C33	
C63	Same as C34	
C64	Same as C35	
C65 thru C67	Same as C7	
C68	Same as C10	
C69	Same as C7	
C70	Same as C12	
C71 thru C73	Same as C7	
C74	Not used	
C75	Same as C10	
C76 thru C80	Same as C7	
C81	Same as C10	
C82 thru C85	Same as C7	
C86	Same as C27	
C87	Same as C28	
C88 thru C91	Same as C7	

STEP GENERATOR C A-4506

REF SYMBOL	DESCRIPTION	TMC PART NUMBER
C92 thru C96	Same as C2	
C97	Capacitor, Fixed, Mica, 180 uuf, $\pm 2\%$, 500 WVDC	CM111F181G5S
C98	Same as C2	
C99	Capacitor, Fixed, Mica, 620 uuf, $\pm \frac{1}{2}\%$, 500 WVDC	CM111F621D5S
C100	Same as C99	
C101	Capacitor, Variable, Ceramic, 9 to 35 uuf, 100 WVDC	CV112-2
C102 thru C104	Same as C2	
C105	Same as C6	
C106	Capacitor, Fixed, Mica, 5 uuf, $\pm 10\%$, 500 WVDC	CM111C050K5S
C107	Same as C6	
C108 thru C111	Same as C2	
C112	Same as C6	
C113	Same as C2	
C114	Same as C6	
C115	Same as C106	
C116 thru C118	Same as C2	
C119	Same as C6	
C120	Same as C106	
C121	Same as C6	

STEP GENERATOR C A-4506

REF SYMBOL	DESCRIPTION	TMC PART NUMBER
C122 thru C124	Same as C2	
C125	Same as C12	
C126 thru C128	Same as C2	
C129	Same as C6	
C130	Same as C106	
C131	Same as C6	
C132 thru C135	Same as C2	
C136	Same as C6	
C137	Same as C106	
C138	Same as C6	
C139 thru C142	Same as C2	
C143	Same as C6	
C144	Same as C6	
C145	Same as C106	
C146 thru C148	Same as C2	
C149	Same as C12	
C150	Same as C2	
C151	Same as C2	
CR1	Semiconductor, Device, Diode	DD139

STEP GENERATOR C A-4506

REF SYMBOL	DESCRIPTION	TMC PART NUMBER
CR2	Same as CR1	
CR3	Semiconductor, Device, Diode,	1N627
CR4	Same as CR3	
L1	Coil, Rado Frequency, fixed, .128 uh, $\pm 10\%$	CL412-41
L2	Coil, Radio Frequency, fixed, .11 uh, $\pm 10\%$	CL412-36
L3	Coil, Radio Frequency, fixed, 0.82 uh, $\pm 10\%$, molded case	CL275-0R82
L4 thru C7	Same as L3	
C8	Coil, Radio Frequency, fixed, .205 uh, $\pm 4\%$	CL412-38
L9	Same as L3	
L10	Same as L2	
L11	Coil, Radio Frequency, fixed, .085 uh, $\pm 4\%$	CL412-37
L12 thru L16	Same as L3	
L17	Coil, Radio Frequency, fixed, .205 uh, $\pm 4\%$,	CL412-39
L18	Same as L3	
L19	Same as L2	
L20	Same as L11	
L21 thru L25	Same as L3	
L26	Coil, Radio Frequency, fixed, .155 uh, $\pm 4\%$	CL412-40
L27	Same as L3	
L28	Same as L3	

004692044

STEP GENERATOR C A-4506

REF SYMBOL	DESCRIPTION	TMC PART NUMBER
L29	Coil, Radio Frequency, fixed, 129 uh, $\pm 10\%$, molded case	CL275-121
L30	Same as L29	
L31	Coil, Radio Frequency, fixed, 12 uh, $\pm 10\%$, molded case	CL275-120
L32 thru L40	Same as L29	
Q1	Transistor	2N3600
Q2 thru Q13	Same as Q1	
Q14	Transistor	2N3646
Q15 thru Q20	Same as Q14	
R1	Resistor, Fixed, Composition, 56 ohms, $\pm 5\%$, $\frac{1}{4}$ watt	RC07GF560J
R2	Resistor, Fixed, Composition, 1000 ohms, $\pm 5\%$, $\frac{1}{4}$ watt	RC07GF102J
R3	Resistor, Fixed, Composition, 8200 ohms, $\pm 5\%$, $\frac{1}{4}$ watt	RC07GF822J
R4	Resistor, Fixed, Composition, 2200 ohms, $\pm 5\%$, $\frac{1}{4}$ watt	RC07GF222J
R5	Resistor, Fixed, Composition, 18 ohms, $\pm 5\%$, $\frac{1}{4}$ watt	RC07GF180J
R6	Resistor, Fixed, Composition, 220 ohms, $\pm 5\%$, $\frac{1}{4}$ watt	RC07GF221J
R7	Resistor, Fixed, Composition, 12 ohms, $\pm 5\%$, $\frac{1}{4}$ watt	RC07GF120J
R8	Same as R2	
R11	Resistor, Fixed, Composition, 22 ohms, $\pm 5\%$, $\frac{1}{4}$ watt	RC07GF220J
R12	Same as R6	
R13	Same as R7	

STEP GENERATOR C A-4506

REF SYMBOL	DESCRIPTION	TMC PART NUMBER
R14	Same as R2	
R15	Same as R3	
R16	Same as R10	
R17	Resistor, Fixed, Composition, 10 ohms, $\pm 5\%$, $\frac{1}{4}$ watt	RC07GF100J
R18	Same as R6	
R19	Same as R7	
R20	Resistor, Fixed, Composition, 1500 ohms, $\pm 5\%$, $\frac{1}{4}$ watt	RC07GF152J
R21	Same as R3	
R22	Same as R10	
R23	Same as R17	
R24	Resistor, Fixed, Composition, 180 ohms, $\pm 5\%$, $\frac{1}{4}$ watt	RC07GF181J
R25	Same as R1	
R26	Same as R2	
R27	Same as R3	
R28	Same as R4	
R29	Same as R17	
R30	Same as R6	
R31	Resistor, Fixed, Composition, 68 ohms, $\pm 5\%$, $\frac{1}{4}$ watt	RC07GF680J
R32	Same as R2	
R33	Same as R3	
R34	Same as R10	
R35	Same as R11	
R36	Same as R6	
R37	Resistor, Fixed, Composition, 47 ohms, $\pm 5\%$, $\frac{1}{4}$ watt	RC07GF470J

STEP GENERATOR C A-4506

REF SYMBOL	DESCRIPTION	TMC PART NUMBER
R38	Same as R2	
R39	Same as R3	
R40	Same as R10	
R41	Same as R17	
R42	Same as R6	
R43	Same as R37	
R44	Same as R20	
R45	Same as R3	
R46	Same as R10	
R47	Same as R17	
R48	Same as R24	
R49	Same as R1	
R50	Same as R2	
R51	Same as R3	
R52	Same as R4	
R53	Same as R17	
R54	Same as R6	
R55	Same as R31	
R56	Same as R2	
R57	Same as R3	
R58	Same as R10	
R59	Same as R11	
R60	Same as R6	
R61	Same as R37	

STEP GENERATOR C A-4506

REF SYMBOL	DESCRIPTION	TMC PART NUMBER
R62	Same as R2	
R63	Same as R3	
R64	Same as R10	
R65	Same as R17	
R66	Same as R6	
R67	Same as R37	
R68	Same as R2	
R70	Same as R10	
R71	Same as R17	
R72	Same as R24	
R73	Resistor, Fixed, Composition, 3300 ohms, $\pm 5\%$, $\frac{1}{4}$ watt	RC07GF332J
R74	Same as R20	
R75	Same as R10	
R76	Resistor, Fixed, Composition, 6.8 ohms, $\pm 5\%$, $\frac{1}{4}$ watt	RC07GF6R8J
R77	Same as R10	
R78	Resistor, Variable, Composition, 100 ohms, $\pm 30\%$,	RV124-1-101
R79	Same as R2	
R80	Same as R3	
R81	Resistor, Fixed, Composition, 330 ohms, $\pm 5\%$, $\frac{1}{4}$ watt	RC07GF331J
R82	Resistor, Fixed, Composition, 4.7 ohms, $\pm 5\%$, $\frac{1}{4}$ watt	RC07GF4R7J
R83	Same as R24	
R84	Same as R78	
R85	Resistor, Fixed, Composition, 120 ohms, $\pm 5\%$, $\frac{1}{4}$ watt	RC07GF121J
R86	Same as R5	

STEP GENERATOR C A-4506

REF SYMBOL	DESCRIPTION	TMC PART NUMBER
R87	Resistor, Fixed, Composition, 100 ohms, $\pm 5\%$, $\frac{1}{4}$ watt	RC07GF101J
R88	Same as R87	
R89	Same as R2	
R90	Same as R3	
R91	Same as R81	
R92	Resistor, Fixed, Composition, 1200 ohms, $\pm 5\%$, $\frac{1}{4}$ watt	RC07GF122J
R93	Resistor, Fixed, Composition, 15 ohms, $\pm 5\%$, $\frac{1}{4}$ watt	RC07GF150J
R94	Same as R24	
R95	Same as R2	
R96	Same as R3	
R97	Same as R81	
R98	Same as R92	
R99	Same as R11	
R100	Same as R85	
R101	Same as R2	
R102	Resistor, Fixed, Composition, 6800 ohms, $\pm 5\%$, $\frac{1}{4}$ watt	RC07GF682J
R103	Same as R92	
R104	Resistor, Fixed, Composition, 820 ohms, $\pm 5\%$, $\frac{1}{4}$ watt	RC07GF821J
R105	Resistor, Fixed, Composition, 27 ohms, $\pm 5\%$, $\frac{1}{4}$ watt	RC07GF270J
R106	Same as R5	
R107	Same as R2	
R108	Same as R3	
R109	Same as R81	
R110	Same as R93	

STEP GENERATOR C A-4506

REF SYMBOL	DESCRIPTION	TMC PART NUMBER
R111	Same as R24	
R112	Same as R2	
R113	Same as R3	
R114	Same as R81	
R115	Same as R92	
R116	Same as R11	
R117	Same as R85	
R118	Same as R2	
R119	Same as R102	
R120	Same as R92	
R121	Same as R104	
R122	Same as R105	
R123	Same as R24	
R124	Same as R92	
T1	Transformer, Radio Frequency, fixed	TZ215-6
T2	Same as T1	
T3	Same as T1	
T4	Transformer, Radio Frequency, fixed	TZ215-8
T5	Same as T4	
T6	Same as T4	
T7	Transformer, Radio Frequency, fixed	TZ215-10
T8	Same as T7	
T9	Same as T7	
T10	Transformer, Radio Frequency, fixed	TZ215-11

STEP GENERATOR C A-4506

REF SYMBOL	DESCRIPTION	TMC PART NUMBER
T11	Transformer, Radio Frequency, fixed	TT287-19
T12	Transformer, Radio Frequency, fixed	TT287-9
T13	Transformer, Radio Frequency, fixed	TT287-12
T14	Transformer, Radio Frequency, fixed	TT287-10
T15	Same as T13	
T16	Same as T14	
T17	Same as T13	
T18	Transformer, Radio Frequency, Fixed	TT287-21
T19	Same as T12	
T20	Same as T13	
T21	Same as T14	
T22	Same as T13	
T23	Same as T14	
T24	Same as T13	
T25	Same as T18	
Y1	Crystal, Unit Quartz, 12 MHZ	CR109-124

FILTER A-4507

REF SYMBOL	DESCRIPTION	TMC PART NUMBER
C1	Capacitor, Fixed, Ceramic, 10,000, GMV, 500 WVDC	CC100-16
C2	Same as C1	
C3	Capacitor, Fixed, Mica, 680 uufd, $\pm 2\%$, 500 WVDC	CM111F681G5S
C4	Capacitor, Fixed, Mica, 430 uufd, $\pm 2\%$, 500 WVDC	CM111F431G5S
C5	Capacitor, Fixed, Mica, 750 uufd, $\pm 2\%$, 500 WVDC	CM111F751G5S
C6	Capacitor, Fixed, Mica, 820 uufd, $\pm 2\%$, 500 WVDC	CM111F821G5S
C7	Capacitor, Fixed, Mica, 910 uufd, $\pm 2\%$, 500 WVDC	CM111F911G5S
C8	Capacitor, Fixed, Mica, 560 uufd, $\pm 1\%$, 500 WVDC	CM111F561F5S
C9	Capacitor, Fixed, Mica, 510 uufd, $\pm 2\%$, 500 WVDC	CM111F511G5S
C10	Capacitor, Fixed, Mica, 1000 uufd, $\pm 1\%$, 500 WVDC	CM111F102F5S
C11	Same as C10	
C12	Capacitor, Fixed, Mica, 200 uufd, $\pm 2\%$, 500 WVDC	CM111F201G5S
C13	Same as C5	
C14	Same as C5	
C15	Same as C1	
C16	Same as C5	
C17	Capacitor, Fixed, Mica, 390 uufd, $\pm 2\%$, 500 WVDC	CM111F391G5S
C18	Capacitor, Fixed, Mica, 1100 uufd, $\pm 1\frac{1}{2}\%$, 500 WVDC	CM112F112D5S
C19	Same as C8	
C20	Capacitor, Fixed, Mica, 1300 uufd, $\pm 1\%$, 500 WVDC	CM112F132F5S
C21	Capacitor, Fixed, Mica, 110 uufd, $\pm 5\%$, 500 WVDC	CM111F111J5S
C22	Same as C7	
C23	Same as C1	
C24	Capacitor, Fixed, Mica, 360 uufd, $\pm 2\%$, 500 WVDC	CM111F361G5S

FILTER A-4507

REF SYMBOL	DESCRIPTION	TMC PART NUMBER
C25	Capacitor, Fixed, Mica, 330 uufd, $\pm 2\%$, 500 WVDC	CM111F331G5S
C26	Capacitor, Variable, Ceramic, 15-60 uufd, 100 WVDC	CV112-5
C27	Same as C8	
C28	Capacitor, Fixed, Mica, 470 uufd, $\pm 1\%$, 500 WVDC	CM111F471F5S
C29	Same as C26	
C30	Capacitor, Fixed, Mica, 620 uufd, $\pm 1\%$, 500 WVDC	CM111F621F5S
C31	Capacitor, Fixed, Mica, 36 uufd, $\pm 5\%$, 500 WVDC	CM111E360J5S
C32	Same as C26	
C33	Same as C9	
C34	Same as C1	
C35	Capacitor, Fixed, Mica, 220 uufd, $\pm 2\%$, 500 WVDC	CM111F221G5S
C36	Capacitor, Fixed, Mica, 150 uufd, $\pm 1\%$, 500 WVDC	CM111F151F5S
C37	Same as C26	
C38	Same as C25	
C39	Same as C35	
C40	Same as C26	
C41	Same as C17	
C42	Capacitor, Fixed, Mica, 24 uufd, $\pm 5\%$, 500 WVDC	CM111C240J5S
C43	Capacitor, Variable, Ceramic, 9-35 uufd, 100 WVDC	CV112-2
C44	Capacitor, Fixed, Mica, 330 uufd, $\pm 2\%$, 500 WVDC	CM111F301G5S
C45	Same as C1	
C46	Capacitor, Fixed, Mica, 130 uufd, $\pm 2\%$, 500 WVDC	CM111F131G5S
C47	Capacitor, Fixed, Mica, 560 uufd, $\pm 5\%$, 500 WVDC	CM111E560J5S
C48	Same as C26	

FILTER A-4507

REF SYMBOL	DESCRIPTION	TMC PART NUMBER
C49	Same as C35	
C50	Capacitor, Fixed, Mica, 100 uufd, $\pm 1\%$, 500 WVDC	CM111F101F5S
C51	Same as C26	
C52	Capacitor, Fixed, Mica, 240 uufd, $\pm 2\%$, 500 WVDC	CM111F241G5S
C53	Capacitor, Fixed, Mica	CM111C050K5S
C54	Same as C43	
C55	Capacitor, Fixed, Mica, 180 uufd, $\pm 2\%$, 500 WVDC	CM111F181G5S
C56	Same as C1	
C57	Same as C46	
C58	Same as C55	
C59	Capacitor, Fixed, Mica 120 uufd, $\pm 2\%$, 500 WVDC	CM111F121G5S
C60	Capacitor, Variable, Ceramic, 2-8 uufd, 200 WVDC	CV112-4
C61	Same as C26	
K1	Relay, Armature	RL143-4
K2	Same as K1	
K3	Same as K1	
K4	Same as K1	
K5	Same as K1	
K6	Same as K1	
L1	Coil, R.F., Fixed, 2.69 uh, $\pm 4\%$,	CL412-2
L2	Coil, R.F., Fixed, 2.49 uh, $\pm 4\%$,	CL412-3
L3	Coil, R.F., Fixed, 3.80 uh, $\pm 4\%$,	CL412-1
L4	Coil, R.F., Fixed, 1.78 uh, $\pm 4\%$,	CL412-5
L5	Coil, R.F., Fixed, 1.68 uh, $\pm 4\%$,	CL412-6
L6	Coil, R.F., Fixed, 2.41 uh, $\pm 4\%$,	CL412-4

FILTER A-4507

REF SYMBOL	DESCRIPTION	TMC PART NUMBER
L7	Coil, R.F., Fixed, .85 uh, $\pm 4\%$,	CL412-8
L8	Coil, R.F., Fixed, .76 uh, $\pm 4\%$,	CL412-10
L9	Coil, R.F., Fixed, 1.32 uh, $\pm 4\%$	CL412-7
L10	Coil, R.F., Fixed, .52 uh, $\pm 4\%$,	CL412-11
L11	Coil, R.F., Fixed, .47 uh, $\pm 4\%$,	CL412-13
L12	Coil, R.F., Fixed, .78 uh, $\pm 4\%$,	CL412-9
L13	Coil, R.F., Fixed, .34 uh, $\pm 4\%$,	CL412-14
L14	Coil, R.F., Fixed, .31 uh, $\pm 4\%$,	CL412-15
L15	Coil, R.F., Fixed, .48 uh, $\pm 4\%$,	CL412-12
L16	Coil, R.F., Fixed, 120 uh, $\pm 10\%$,	CL275-121
L17	Same as L16	
L18	Same as L16	
L19	Same as L16	
L20	Same as L16	
L21	Same as L16	
L22	Same as L16	
L23	Coil, R.F., Fixed, .21 uh, $\pm 4\%$	CL412-16
L24	Coil, R.F., Fixed, .19 uh, $\pm 4\%$	CL412-17

PC BD A POWER SUPPLY A-4512

REF SYMBOL	DESCRIPTION	TMC PART NUMBER
C1	Capacitor, Fixed, Electrolytic, 200 mfd, 50 WVDC	CE105-200-50
C2	Same as C1	
C3	Capacitor, Fixed, Electrolytic, 150 mfd, 75 WVDC	CE105-150-75
C4	Same as C3	
CR1	Rectifier, Semiconductor, Device	DD130-200-40

PC BD B POWER SUPPLY A-4513

REF SYMBOL	DESCRIPTION	TMC PART NUMBER
C1	Capacitor, Fixed Electrolytic, 25 mfd, +50-15%, 50 WVDC	CE107-6
C2	Same as C1	
C3	Same as C1	
C4	Same as C1	
C5	Same as C1	
CR1	Semiconductor, Device Diode	1N100
CR2	Same as CR1	
CR3	Semiconductor, Device, Diode	1N4619
CR4	Semiconductor, Device, Diode	1N753A
CR5	Same as CR3	
CR6	Semiconductor, Device, Diode	1N972B
CR7	Same as CR4	
Q1	Transistor	2N1481
Q2	Same as Q1	
Q3	Same as Q1	
Q4	Transistor	2N3638
Q5	Same as Q1	
Q6	Same as Q4	
Q7	Same as Q1	
R1	Resistor, Fixed, Composition, 470 ohms, ±5%, ¼ watt	RC07GF471J
R2	Resistor, Fixed, Composition, 1000 ohms, ±5%, ¼ watt	RC07GF102J
R3	Resistor, Variable, Composition, 1000 ohms, ±30%, ½ watt	RV124-1-102
R4	Same as R2	

PC BD B POWER SUPPLY A-4513

REF SYMBOL	DESCRIPTION	TMC PART NUMBER
R6	Resistor, Fixed, Composition, 10000 ohms, $\pm 5\%$, $\frac{1}{4}$ watt	RC07GF103J
R7	Same as R2	
R8	Same as R3	
R9	Resistor, Fixed, Composition, 4700 ohms, $\pm 5\%$, $\frac{1}{4}$ watt	RC07GF472J
R10	Resistor, Fixed, Composition, 1500 ohms, $\pm 5\%$, $\frac{1}{4}$ watt	RC07GF152J
R11	Resistor, Fixed, Wirewound, 10 ohms, $\pm 2\%$, 5 watt	RR114-10W2
R12	Same as R3	
R13	Resistor, Fixed, Composition, 6800 ohms, $\pm 5\%$, $\frac{1}{4}$ watt	RC07GF682J
R14	Same as R2	
R15	Same as R11	
R16	Resistor, Fixed, Composition, 4700 ohms, $\pm 5\%$, $\frac{1}{4}$ watt	RC07GF472J
R17	Resistor, Fixed, Composition, 150 ohms, $\pm 5\%$, $\frac{1}{4}$ watt	RC07GF151J
R18	Resistor, Variable, Composition	RV124-1-103
R19	Same as R17	

SIDEBAND GENERATOR A-4524

REF SYMBOL	DESCRIPTION	TMC PART NUMBER
C1	Capacitor, Fixed, Ceramic, 100,000 uufd, +80%-20%, 100 WVDC	CC100-28
C2	Capacitor, Fixed, Electrolytic, 75 mfd, 15 WVDC	CE105-75-15
C3	Same as C1	
C5	Capacitor, Fixed, Electrolytic, 10 mfd, 25 WVDC	CE105-10-25
C4	Capacitor, Fixed, Mica, 22 uufd, ±5%, 500 WVDC	CM111C220J5S
C6	Same as C5	
C7	Capacitor, Fixed, Ceramic, 10,000 uufd, 25 WVDC	CC100-41
C8	Capacitor, Fixed, Electrolytic, 2 mfd, 50 WVDC	CE105-2-50
C9	Same as C5	
C10	Same as C7	
C11	Capacitor, Fixed, Electrolytic, 2 uufd, 50 WVDC	CE105-2-50
C12 thru C15	Same as C5	
C16	Same as C1	
C17	Same as C5	
C18	Same as C7	
C19	Same as C1	
C20	Same as C7	
C21	Capacitor, Fixed, Electrolytic, 3900 uufd, ±1%, 30 WVDC	CM112F392F5S
C22 thru C32	Same as C1	
C33	Same as C5	
C34	Same as C5	
C35	Same as C1	

SIDEBAND GENERATOR A-4524

REF SYMBOL	DESCRIPTION	TMC PART NUMBER
C36	Same as C5	
C37	Same as C7	
C38	Same as C1	
C39	Same as C7	
C40	Same as C21	
C41 thru C48	Same as C1	
C49	Capacitor, Fixed, Electrolytic, 50 mf, 50 WVDC	CE105-50-50
C50	Capacitor, Fixed, Mica, 150 uufd, $\pm 1\%$, 500 WVDC	CM111F151F5S
C51	Same as C50	
C52	Capacitor, Variable, Ceramic, 15-60 uufd, 100 WVDC	CV112-5
C53	Same as C52	
CR1	Semiconductor, Device Diode	1N541
CR2 thru CR8	Same as CR1	
L1	Coil, Fixed, R.F., 1000 ohms, $\pm 20\%$, 135 ma	CL275-102
L2	Coil, Fixed, R.F., 220 ohms, $\pm 20\%$, 250 ma	CL275-221
L3	Coil, Fixed, R.F. 3300 ohms, $\pm 20\%$, 80 ma	CL275-332
L4	Same as L3	
Q1	Transistor, Silicon	
Q2	Transistor, Same as Q1	
Q3	Transistor, Same as Q1	
Q4	Transistor, Same as Q1	
Q5	Transistor, Same as Q1	
Q6	Transistor, Same as Q1	

SIDEBAND GENERATOR A-4524

REF SYMBOL	DESCRIPTION	TMC PART NUMBER
Q7 thru Q13	Transistor, Same as Q1	
R1	Resistor, Fixed, Composition, 220 ohms, $\pm 5\%$, $\frac{1}{4}$ watt	RC07GF221J
R2	Resistor, Fixed, Composition, 4700 ohms, $\pm 5\%$,	RC07GF221J
R3	Resistor, Fixed, Composition, 10,000 ohms, $\pm 5\%$, $\frac{1}{4}$ watt	RC07GF103J
R4	Resistor, Fixed, Composition, 56,000 ohms, $\pm 5\%$ $\frac{1}{4}$ watt	RC07GF563J
R5	Resistor, Fixed, Composition, 100,000 ohms, $\pm 5\%$, $\frac{1}{4}$ watt	RC07GF104J
R6	Same as R4	
R7	Resistor, Fixed, Composition 470,000 ohms, $\pm 5\%$, $\frac{1}{4}$ watt	RC07GF474J
R8	Same as R3	
R9	Resistor, Variable, Composition, 10,000 ohms, $\pm 30\%$, $\frac{1}{2}$ watt	RV124-1-103
R10	Resistor, Fixed, Composition, 22,000 ohms, $\pm 5\%$, $\frac{1}{4}$ watt	RC07GF223J
R11	Same as R3	
R12	Resistor, Fixed, Composition 1500 ohms, $\pm 5\%$, $\frac{1}{4}$ watt	RC07GF152J
R13	Resistor, Fixed, Composition 100 ohms, $\pm 5\%$, $\frac{1}{4}$ watt	RC07GF101J
R14	Resistor, Fixed, Composition, 470 ohms, $\pm 5\%$, $\frac{1}{4}$ watt	RC07GF471J
R15	Same as R10	
R16	Same as R3	
R17	Same as R12	
R18	Same as R13	
R19	Same as R14	

SIDEBAND GENERATOR A-4524

REF SYMBOL	DESCRIPTION	TMC PART NUMBER
R20	Same as R2	
R21	Resistor, Fixed, Composition, 15,000 ohms, ±5%, ¼ watt	RC07GF153J
R22	Resistor, Fixed, Composition, 1000 ohms, ±5%, ¼ watt	RC07GF102J
R23	Resistor, Fixed, Composition, 33,000 ohms, ±5%, ¼ watt	RC07GF333J
R24	Same as R21	
R25	Same as R22	
R26	Same as R22	
R27	Same as R14	
R28	Resistor, Variable, Composition, 100 ohms, ±30%, ¼ watt	RV124-1-101
R29	Same as R14	
R30	Same as R22	
R31	Same as R23	
R32	Same as R3	
R33	Same as R22	
R34	Same as R28	
R35	Same as R14	
R36	Same as R22	
R37	Same as R14	
R38	Same as R3	
R39	Resistor, Fixed, Composition, 1200 ohms, ±5%, ¼ watt	RC07GF122J
R40	Same as R3	
R41	Same as R22	

SIDEBAND GENERATOR A-4524

REF SYMBOL	DESCRIPTION	TMC PART NUMBER
R42	Same as R3	
R43	Resistor, Fixed, Composition, 27000 ohms, $\pm 5\%$, $\frac{1}{4}$ watt	RC07GF273J
R44	Same as R22	
R45	Same as R22	
R46	Same as R43	
R47	Same as R3	
R48	Same as R22	
R49	Same as R23	
R50	Same as R21	
R51	Same as R22	
R52	Same as R22	
R53	Same as R14	
R54	Same as R28	
R55	Same as R14	
R56	Same as R22	
R57	Same as R23	
R58	Same as R3	
R59	Same as R22	
R60	Same as R28	
R61	Same as R14	
R62	Same as R22	
R63	Same as R39	
R64	Same as R14	
R65	Same as R3	

SIDEBAND GENERATOR A-4524

REF SYMBOL	DESCRIPTION	TMC PART NUMBER
R66	Same as R3	
R67	Same as R22	
R68	Same as R39	
R69	Same as R39	
R70	Same as R22	
R71	Same as R13	
R72	Same as R13	
T1	Transformer, R.F. Tuned	TT285-11
T2	Same as T1	
T3	Transformer, Audio Frequency	TF0359
T4	Same as T3	
TP1	Term, Stud	TE0-127-2
TP2	Same as TP1	
TP3	Same as TP1	
TP4	Same as TP1	
TP5	Same as TP1	
TP6	Same as TP1	
TP7 thru TP10	Term, Stud, Same as TP1	TE127-2

FREQUENCY SHIFT GENERATOR A-4525

REF SYMBOL	DESCRIPTION	TMC PART NUMBER
C1001	Capacitor, Fixed, Ceramic, 100000 uufd, ±80-20%, 100 WVDC	CC100-28
C1002	Capacitor, Fixed, Ceramic, 100000 uufd, ±80-20%, 25 WVDC	CC100-41
C1003	Same as C1002	
C1004	Same as C1001	
C1005	Same as C1002	
C1006	Capacitor, Fixed, Mica, 270 uufd, ±1%, 500 WVDC	CM111F271F5S
C1008	Same as C1002	
C1009	Same as C1002	
C1010	Same as C1002	
C1011	Same as C1002	
C1012	Capacitor, Fixed, Ceramic, 360 uufd, ±2%, 500 WVDC	CM111F361G5S
C1013	Same as C1002	
C1014	Capacitor, Fixed, Ceramic, 1000 uufd, GMV, 500WVDC	CC100-29
C1015	Capacitor, Fixed, Ceramic, 330 uufd, ±2%, 500 WVDC	CM111F331G5S
C1016	Same as C1014	
C1017	Same as C1014	
C1018	Same as C1001	
C1019	Same as C1002	
C1020	Same as C1002	
C1021	Same as C1002	
C1022	Capacitor, Fixed, Ceramic, 20000 uufd, +80-20%, 25 WVDC	CC100-40
C1023	Same as C1002	
C1024	Same as C1002	

FREQUENCY SHIFT GENERATOR A-4525

REF SYMBOL	DESCRIPTION	TMC PART NUMBER
C1025	Same as C1002	
C1026	Same as C1002	
C1027	Capacitor, Fixed, Ceramic, 200,000 uufd, +80-20%, 25 WVDC	CC100-33
C1028	Same as C1022	
C1029	Capacitor, Fixed, Ceramic, 5 uufd, ±10%, 500 WVDC	CM111C050K55
C1030	Same as C1028	
C1031	Same as C1002	
C1032	Same as C1001	
C1033	Same as C1002	
CR1001	Semiconductor, Device, Diode	IN755A
CR1002	Same as CR1001	
CR1003	Semiconductor, Device, Diode	IN627
CR1004	Same as CR1003	
CR1005	Same as CR1003	
CR1006	Same as CR1003	
CR1007	Same as CR1003	
CR1008	Semiconductor, Device, Diode	IN914
CR1009	Same as CR1008	
CR1010	Semiconductor, Device, Diode	IN34A
CR1011	Same as CR1010	
CR1012	Same as CR1010	
CR1013	Same as CR1010	
CR1014	Subconductor, Device, Diode	IN754A
FL1001	Filter, Bandpass	FX268

FREQUENCY SHIFT GENERATOR A-4525

REF SYMBOL	DESCRIPTION	TMC PART NUMBER
L1001	Coil, R.F., Fixed 1000 uhy, $\pm 10\%$, 135 ma	CL275-102
L1002	Same as L1001	
L1003	Coil, R.F., Fixed, 220 uhy, $\pm 10\%$, 250 ma	CL275-221
L1004	Coil, R.F., Fixed, 100 uhy, $\pm 10\%$, 432 ma	CL275-101
L1005	Same as L1004	
Q1001	Transistor, Silicon	2N3646
Q1002	Same as Q1001	
Q1003	Same as Q1001	
Q1004	Same as Q1001	
Q1005	Transistor	2N696
Q1006	Transistor, Silicon	2N1711
Q1007	Same as Q1006	
Q1008	Same as Q1005	
Q1009	Same as Q1005	
Q1010	Same as Q1005	
Q1012	Same as Q1001	
Q1013	Same as Q1001	
R1001	Resistor, Fixed, Composition, 22000 ohms, $\pm 5\%$, $\frac{1}{4}$ watt	RC07GF223J
R1002	Resistor, Fixed, Composition, 33000 ohms, $\pm 5\%$, $\frac{1}{4}$ watt	RC07GF333J
R1003	Resistor, Fixed, Composition, 33 ohms, $\pm 5\%$, $\frac{1}{4}$ watt	RC07GF330J
R1004	Resistor, Fixed, Composition, 560 ohms, $\pm 5\%$, $\frac{1}{4}$ watt	RC07GF561J
R1005	Resistor, Fixed, Composition, 330 ohms, $\pm 5\%$, $\frac{1}{4}$ watt	RC07GF331J
R1011	Resistor, Fixed, Composition, 15000 ohms, $\pm 5\%$, $\frac{1}{4}$ watt	RC07GF153J
R1012	Same as R1001	
R1013	Resistor, Fixed, Composition, 470 ohms, $\pm 5\%$, $\frac{1}{4}$ watt	RC07GF471J

FREQUENCY SHIFT GENERATOR A4525

REF SYMBOL	DESCRIPTION	TMC PART NUMBER
R1014	Resistor, Fixed, Composition, 680 ohms $\pm 5\%$, $\frac{1}{4}$ watt	RC07GF681J
R1015	Resistor, Fixed, Composition, 1000 Ohms, $\pm 5\%$, $\frac{1}{4}$ watt	RC07GF102J
R1016	Resistor, Fixed, Composition, 1500 ohms, $\pm 5\%$, $\frac{1}{4}$ watt	RC07GF152J
R1017	Same as R1011	
R1018	Same as R1001	
R1019	Same as R1013	
R1020	Resistor, Fixed, Composition, 100 ohms, $\pm 5\%$, $\frac{1}{4}$ watt	RC07GF101J
R1021	Same as R1015	
R1022	Resistor, Fixed, Composition, 220 ohms, $\pm 5\%$, $\frac{1}{4}$ watt	RC07GF221J
R1023	Resistor, Fixed, Composition, 100000 ohms, $\pm 5\%$, $\frac{1}{4}$ watt	RC07GF104J
R1024	Resistor, Fixed, Composition, 10000 ohms, $\pm 5\%$, $\frac{1}{2}$ watt	RC07GF103J
R1025	Resistor, Variable, WW, 1000 ohms, $\pm 30\%$, $\frac{1}{2}$ watt	RV119-3-102
R1026	Same as R1024	
R1027	Resistor, Variable, WW, 10000 ohms, $\pm 30\%$, $\frac{1}{2}$ watt	RV119-3-103
R1028	Same as R1024	
R1029	Resistor, Fixed, Composition, 47000 ohms, $\pm 5\%$, $\frac{1}{2}$ watt	RC07GF473J
R1030	Same as R1029	
R1031	Same as R1029	
R1032	Same as R1029	
R1034	Resistor, Fixed, Composition, 6800 ohms, $\pm 5\%$, $\frac{1}{2}$ watt	RC07GF682J
R1035	Same as R1025	
R1036	Same as R1027	
R1037	Same as R1027	
R1038	Same as R1029	
R1039	Same as R1005	

FREQUENCY SHIFT GENERATOR A4525

REF SYMBOL	DESCRIPTION	TMC PART NUMBER
R1040	Same as R1015	
R1041	Resistor, Fixed, Composition, 2200 ohms, ±5%, ¼watt	RC07GF222J
R1042	Same as R1041	
R1043	Same as R1015	
R1044	Same as R1016	
R1045	Same as R1013	
R1046	Same as R1041	
R1047	Same as R1024	
R1048	Resistor, Fixed, Composition, 4700 ohms, ±5%, ¼ watt	RC07GF472J
R1049	Same as R1015	
R1050	Same as R1001	
R1051	Same as R1024	
R1052	Same as R1001	
R1053	Same as R1001	
R1054	Same as R1013	
R1055	Same as R1048	
R1056	Resistor, Variable, Composition, 10000 ohms, ±30%, ½ watt	RV124-1-103
R1057	Resistor, Fixed, Composition, 3300 ohms, ±5%, ¼ watt	RC07GF332J
R1058	Resistor, Variable, Composition, 100 ohms, ±30%, ½ watt	RV124-1-101
R1060	Same as R1015	
Z1001	Network Frequency, Divider	NW137
Z1002	NW BAL MIXER	NW163
T1001	XFormer, R.F., Adj	TT285-6
T1002	Same as T1001	

FREQUENCY SHIFT GENERATOR A4525

REF SYMBOL	DESCRIPTION	TMC PART NUMBER
T1003	XFormer, IF	TZ216
T1004	XFormer, Toriod	TZ218
TP1001	Term, Stud.	TE0127-2
TP1002 thru TP1008	Same as TP1001	

CARRIER GENERATOR A-4526

REF SYMBOL	DESCRIPTION	TMC PART NUMBER
C1101	Capacitor, Fixed, Ceramic 10,000 uuf, +80%-20%	CC100-41
C1102	Capacitor, Fixed, Ceramic 100,000 uuf, +80%-20% 100 WVDC	CC100-28
C1103	Same as C1101	
C1104	Same as C1101	
C1105	Capacitor, Fixed, Mica 3900 uuf, ±1%, 500 WVDC	CM112F392F5S
C1106	Same as C1102	
C1107	Same as C1102	
C1108	Same as C1102	
C1109	Same as C1105	
C1110	Same as C1102	
C1111	Same as C1102	
C1112	Same as C1102	
C1113	Capacitor, Fixed, Electrolytic 10 uf, 25 WVDC	CE105-10-25
C1114	Same as C1101	
C1115	Same as C1102	
C1116	Same as C1102	
C1117	Same as C1113	
C1118	Same as C1113	
C1119	Capacitor, Fixed, Electrolytic, 2 uf, 50 WVDC	CE105-2-50
C1120	Same as C1119	
C1121	Same as C1101	
C1122	Capacitor, Fixed, Mica 100 uuf, ±1%, 500 WVDC	CM111F101F5S
C1123	Same as C1101	
C1125	Same as C1101	

CARRIER GENERATOR A-4526

REF SYMBOL	DESCRIPTION	TMC PART NUMBER
C1126	Same as C1101	
C1127	Capacitor, Fixed, Ceramic: 1000 uuf, 500 WVDC	CC100-29
C1129	Same as C1122	
C1130	Same as C1101	
C1132	Capacitor, Fixed, Electrolytic, 125 uuf, 15 WVDC	CE105-125-15
C1133	Same as C1132	
C1134	Same as C1101	
C1135	Same as C1102	
C1136	Same as C1113	
C1137	Capacitor, Fixed, Electrolytic, 40 uuf, 15 WVDC	CE105-40-15
C1138	Capacitor, Fixed, Electrolytic, 100 uuf, 15 WVDC	CE105-100-15
C1139	Same as C1105	
C1140	Same as C1102	
C1141	Same as C1102	
C1142	Same as C1127	
C1143	Capacitor, Fixed, Ceramic 200,00 uuf, 25 WVDC	CC100-33
C1144	Same as C1143	
C1145	Same as C1143	
C1146	Capacitor, Fixed, Ceramic 20,000 uuf, 25 WVDC	CC100-40
C1147	Same as C1146	
C1148	Same as C1102	
C1149	Same as C1102	
C1150	Capacitor, Fixed, Electrolytic, 25 uuf, 25 WVDC	CE105-25-25
C1151	Capacitor, Fixed, Electrolytic, 175 uuf, 15 WVDC	CE105-175-15
C1152	Same as C1101	

CARRIER GENERATOR A-4526

REF SYMBOL	DESCRIPTION	TMC PART NUMBER
C1153	Same as C1102	
C1154	Same as C1102	
CR1101	Semiconductor, Device, Diode Silicon	1N746A
CR1102	Semiconductor, Device, Diode, Silicon	1N34A
F11101	Filter Bandpass, 2.75 MHz Symmetrical	FX267
L1101	Coil, Radio Frequency, Fixed: 1000 uh, ±20%, 135 MA	CL275-102
L1102	Coil, Radio Frequency, Fixed: 220 uh, ±20%, 250 MA	CL275-221
L1103	Same as L1101	
L1104	Same as L1102	
L1105	Same as L1101	
L1106	Coil, Radio Frequency, Fixed: 330 uh, ±20%, 505 MA	CL275-331
Q1101	Transistor	2N3646
Q1102 thru Q113	Same as Q1101	
R1101	Resistor, Fixed, Composition: 10,000 ohms, ±5%, ¼ watt	RC07GF103J
R1102	Resistor, Fixed, Composition: 27,000 Ohms, ±5%, ¼ watt	RC07GF273J
R1103	Resistor, Fixed, Composition: 1000 ohms, ±5%, ¼ watt	RC07GF102J
R1104	Same as R1103	
R1105	Resistor, Fixed, Composition: 180 ohms, ±5%, ½ watt	RC20GF181J
R1106	Resistor, Fixed, Composition: 470 ohms, ±5%, ¼ watt	RC07GF471J
R1107	Same as R1106	
R1108	Resistor, Fixed, Composition: 33,000 ohms, ±5%, ¼ watt	RC07GF333J

CARRIER GENERATOR A-4526

REF SYMBOL	DESCRIPTION	TMC PART NUMBER
R1109	Same as R1101	
R1110	Same as R1103	
R1111	Resistor, Fixed, Composition: 100 ohms, $\pm 5\%$, $\frac{1}{4}$ watt	RC07GF101
R1112	Same as R1103	
R1113	Same as R1111	
R1114	Same as R1108	
R1115	Same as R1101	
R1116	Same as R1103	
R1117	Same as R1111	
R1118	Same as R1103	
R1119	Resistor, Fixed, Composition: 1500 ohms, $\pm 5\%$, $\frac{1}{4}$ watt	RC07GF152J
R1120	Resistor, Variable, Composition: 100 ohms, $\pm 30\%$, $\frac{1}{2}$ watt	RV124-1-101
R1121	Same as R1106	
R1122	Same as R1103	
R1123	Same as R1103	
R1124	Same as R1102	
R1125	Same as R1101	
R1126	Same as R1103	
R1127	Resistor, Variable, Composition: 1000 ohms, $\pm 30\%$, $\frac{1}{2}$ watt	RV124-1-102
R1128	Resistor, Fixed, Composition: 22,000 ohms, $\pm 5\%$, $\frac{1}{4}$ watt	RC07GF682J
R1129	Resistor, Fixed, Composition: 6800 ohms, $\pm 5\%$, $\frac{1}{4}$ watt	RC07GF682J
R1130	Resistor, Fixed, Composition: 3300 ohms, $\pm 5\%$, $\frac{1}{4}$ watt	RC07GF332J

CARRIER GENERATOR A-4526

REF SYMBOL	DESCRIPTION	TMC PART NUMBER
R1131	Same as R1111	
R1132	Resistor, Fixed, Composition: 1200 ohms, $\pm 5\%$, $\frac{1}{4}$ watt	RC07GF122J
R1133	Resistor, Fixed, Composition: 4700 ohms, $\pm 5\%$, $\frac{1}{4}$ watt	RC07GF472J
R1134	Same as R1101	
R1135	Same as R1101	
R1136	Same as R1111	
R1137	Same as R1103	
R1138	Same as R1108	
R1139	Same as R1101	
R1141	Same as R1101	
R1142	Same as R1128	
R1143	Same as R1101	
R1144	Same as R1103	
R1145	Same as R1103	
R1146	Same as R1103	
R1147	Resistor, Variable, Composition: 10,000 ohms, $\pm 30\%$ $\frac{1}{2}$ watt	RV124-1-103
R1148	Same as R1108	
R1149	Same as R1132	
R1150	Same as R1101	
R1152	Same as R1103	
R1154	Resistor, Fixed, Composition: 1800 ohms, $\pm 5\%$, $\frac{1}{4}$ watt	RC07GF182J
R1155	Same as R1101	
R1156	Same as R1130	

CARRIER GENERATOR A-4526

REF SYMBOL	DESCRIPTION	TMC PART NUMBER
R1157	Same as R1119	
R1158	Resistor, Fixed, Composition: 18 ohms, ±5%, ¼ watt	RC07GF180J
R1159	Same as R1106	
R1160	Resistor, Fixed, Composition: 270 ohms, ±5%, ¼ watt	RC07GF271J
R1162	Same as R1103	
R1163	Resistor, Fixed, Composition: 47000 ohms, ±5%, ¼ watt	RC07GF473J
R1164	Same as R1101	
R1165	Same as R1106	
R1166	Same as R1111	
R1167	Same as R1106	
R1168	Resistor, Fixed, Composition: 47 ohms, ±5%, ¼ watt	RC07GF470J
R1169	Same as R1120	
R1170	Resistor, Fixed, Composition: 8200 ohms, ±5%, ¼ watt	RC07GF822J
R1171	Same as R119	
R1172	Same as R1103	
R1173	Resistor, Fixed, Composition: 330 ohms, ±5%, ¼ watt	RC07GF331J
R1174	Same as R1106	
T1101	Transformer, Radio Frequency: Operating Frequency. 79 MHZ; "L" 100.0 Nom uh; "Q" 40 Min.	TT285-12
T1102	Transformer Radio Frequency: Operating Frequency. 79 MHZ; "L" 100.0 Nom uh; "Q" 30 Min	TT285-11
T1103	Transformer, Radio, Frequency: Operating Frequency 2.5 MHZ; "L" 33.00 Nom uh: "Q" 60 Min.	TT285-13
T1104	Transformer, Radio Frequency: Operating Frequency 2.5 MHZ; "L" 33.00 Nom uh: "Q" 35 Min.	TT285-14
T1105	Transformer, Radio Frequency: Operating Frequency MHZ, "L" 100.0 Nom uh, "Q" 35 Min.	TT285-15

CARRIER GENERATOR A-4526

REF SYMBOL	DESCRIPTION	TMC PART NUMBER
TP1101 TP1103 thru TP1108	Terminal Stud Same as TP1101	TE127-2

120 MC GENETATOR A-4600

REF SYMBOL	DESCRIPTION	TMC PART NUMBER
C16	Cap, Fxd, Mica, 110 uufd, $\pm 5\%$, 500 WVDC	CM111F111J5S
C17	Cap, Fxd, Ceramic, 100 uufd, GMV, 500 WVDC	CC100-30
C18	Same as C17	
C19	Cap, Fxd, Mica, 47 uufd, $\pm 2\%$, 500 WVDC	CM111E470G5S
C20	Cap, Var, Cer, 2-8 uufd, 200 WVDC	CV112-4
C21 thru C24	Same as C17	
C25	Same as C19	
C26	Same as C20	
C27 thru C30	Same as C17	
C31	Same as C20	
C32	Same as C17	
C33	Same as C16	
C34	Cap, Fxd, Cer, 1000 uufd, GMV, 500 WVDC	CC100-29
C35	Same as C34	
C36	Same as C19	
C37	Cap, Var, Cer, 5.5-18 uufd, 200 WVDC	CV112-1
CR1	Scnd Device Diode	DD138
CR2	Same as CR1	
L4	Coil, Rf, Fxd, 1uh, $\pm 10\%$ molded	CL275-1R0
L5	Same as L4	
L6	Same as L4	
L7	Coil, R.F., Fxd, 0.22 uh, $\pm 20\%$, Molded	CL275-OR22
L8	Coil, R.F. Fxd, 120 uh, $\pm 10\%$, molded	CL275-121

120 MC GENERATOR A-4600

REF SYMBOL	DESCRIPTION	TMC PART NUMBER
L9	Same as L8	
Q4	Transistor, Silicon	2N3646
Q5	Same as Q4	
Q6	Transistor	2N5179
R19	Res, Fxd, Comp, 1000 Ohms, $\pm 5\%$, $\frac{1}{4}$ watt	RC07GF102J
R20	Res, Fxd, Comp, 8200 ohms, $\pm 5\%$, $\frac{1}{4}$ watt	RC07GF822J
R21	Res, Fxd, Comp, 330 ohms, $\pm 5\%$, $\frac{1}{4}$ watt	RC07GF331J
R22	Res, Fxd, Comp, 180 ohms, $\pm 5\%$, $\frac{1}{4}$ watt	RC07GF181J
R23	Res, Fxd, Comp, 10 ohms, $\pm 5\%$, $\frac{1}{4}$ watt	RC07GF100J
R24	Same as R19	
R25	Same as R20	
R26	Same as R21	
R27	Same as R22	
R28	Same as R23	
R29	Res, Fxd, Comp, 47000 ohms, $\pm 5\%$, $\frac{1}{4}$ watt	RC07GF473J
R30	Res, Fxd, Comp, 33 ohms, $\pm 5\%$, $\frac{1}{4}$ watt	RC07GF330J
R31	Res, Fxd, Comp, 100000 ohms, $\pm 5\%$, $\frac{1}{4}$ watt	RC07GF104J
R32	Same as R19	
R33	Res, Fxd, Comp, 120 ohms, $\pm 5\%$, $\frac{1}{4}$ watt	RC07GF470J
R34	Same as R23	
R35	Res, Fxd, Comp, 120 ohms, $\pm 5\%$, $\frac{1}{4}$ watt	RC07GF121J
R36	Res, Var, Comp, 500 ohms, $\pm 30\%$, 200 VDC	RV124-1-501
R40	Same as R33	
R115	Same as R33	
R116	Same as R30	

120 MC GENERATOR A-4600

REF SYMBOL	DESCRIPTION	TMC PART NUMBER
R117	Same as R33	
T4	Transformer, Radio Frequency, Fixed	TZ215-4
T5	Same as T4	
T6	Transformer, Radio Frequency, Fixed	TZ215-3
T7	Transformer, Radio Frequency, Fixed	TZ215-2

FILTER A-4654

REF SYMBOL	DESCRIPTION	TMC PART NUMBER
C1	Capacitor, Fixed, Mica, 130 uufd, ±5%, 500 WVDC	CM111F131J5S
C2	Capacitor, Fixed, Mica, 180 uufd, ±2%, 500 WVDC	CM111F181G5S
C3	Capacitor, Fixed, Mica, 120 uufd, ±5%, 500 WVDC	CM111F121J5S
C4	Capacitor, Variable, Ceramic, 2-8 uufd, 200 WVDC	CV112-4
C5	Capcitor, Variable, Ceramic, 15-60 uufd, 100 WVDC	CV112-5
L1	Coil, Fixed, R.F., .21 uh, Q min 55	CL412-16

POWER SUPPLY AX652

REF SYMBOL	DESCRIPTION	TMC PART NUMBER
C301	Capacitor, Fixed, Ceramic, 100000 uufd, +80-20%, 300 WVDC	CC100-37
C302	Capacitor, Fixed, Mtlz, 1.00 mfd, ±20%, 200 WVDC	CN112A-105-M2
C303	Capacitor, Fixed, Electrolytic, 150 mfd, ±10%, 75 WVDC	CE105-150-75
C304	Capacitor, Fixed, Electrolytic, .47 mfd, ±5%,	CN114R47-5
C305 thru C309	Same as C301	
CR301	Semiconductor Device Diode	1N2484
CR302	Same as CR301	
J301	Connector, Receptacle, Male	JJ242-5P
J302	Connector, Receptacle, RF	JJ211
J303	Connector, Receptacle, Female	JJ319-6DPE
J304	Same as J303	
J305	Same as J302	
J306	Connector, Receptacle, Female	JJ242-5S
L301		CL275-121
P301		PL225-8S
R301	Resistor Fixed Composition, 47 ohms, ±5%, ½ watt	RC20GF470J
R302	Resistor Wire Wound Fixed, 5 Watt.	RW107-10
T301	Transformer	
XZ301	Socket, Electronic Tube	TS100-3
XZ302	Same as XZ301	

BMA101

SWITCH ASSEMBLY BRACKET

REF SYMBOL	DESCRIPTION	TMC PART NUMBER
A114	Switch, Rotary Assembly	AS129
R106	Resistor, Variable, Composition, 10000 ohms, $\pm 10\%$, $\frac{1}{2}$ watt	RV106UX8B103A
S103	Switch, Rotary, 1 Section, 30 degree throw,	SW443
S104	Same as S103	
S105	Switch, Rotary, 2 Sections, 30 degree throw,	SW441
S106	Switch, Rotary, 5 Sections, 30 degree throw,	SW440
S107	Switch, Rotary, 2 Sections, 30 degree throw,	SW442

FMA-103

FRAME ASSEMBLY

REF SYMBOL	DESCRIPTION	TMC PART NUMBER
TB101	Assembly, Resistor, Board	A4592
TB102	Assembly, Resistor, Board	A4593

BMA105

SUB ASSEMBLY

REF SYMBOL	DESCRIPTION	TMC PART NUMBER
C101 thru C103	Capacitor, Fixed, Mica, 1000 uufd, ±10%, 300 WVDC	CB21QB102K
C104	Capacitor, Fixed, Ceramic, 10000 uufd, GVM, 500WVDC	CC100-16
C105	Same as C104	
C106	Capacitor, Fixed, Ceramic, 1000 uufd, GMV, 500 WVDC	CC100-29
C107 thru C109	Same as C101	
C110	Same as C104	
C111	Same as C101	
C112	Same as C104	
C113	Same as C101	
C114	Same as C101	
C115	Same as C104	
C116	Same as C101	
C117	Same as C101	
C118	Same as C104	
C119	Capacitor, Fixed, Ceramic, 100,000 uufd, +80-20%, 100 WVDC	CC100-28
C120	Same as C119	
C121	Same as C119	
C127	Same as C119	
C129 thru C131	Same as C119	
C132	Capacitor, Fixed, Ceramic, 200,000 uufd, 25 WVDC	CC100-33
C133	Same as C104	

ETA105

SUB ASSEMBLY

REF SYMBOL	DESCRIPTION	TMC PART NUMBER
C134	Capacitor, Fixed, MTLZ, 1.0 mfd, ±5%, 50 WVDC	CN114-1R0-5J
C135	Same as C119	
C136	Same as C119	
C137	Same as C104	
C138	Same as C106	
C139	Same as C106	
C140	Same as C106	
C141	Same as C119	
C142	Capacitor, Fixed, Ceramic, DUAL, 2 X 10000 uufd, GVM, 1000 WVDC	CC100-23
C143	Same as C142	
C144	Same as C104	
C145	Same as C119	
C146	Same as C106	
C147	Same as C106	
C148	Same as C106	
C149	Same as C104	
C150 thru C153	Same as C106	
C154	Same as C119	
C155	Same as C106	
C156 thru C165	Same as C106	
C166 thru C177	Same as C106	

BMA105

SUB ASSEMBLY

REF SYMBOL	DESCRIPTION	TMC PART NUMBER
C178 thru C180	Same as C106	
C181	Same as C106	
C182	Same as C106	
C183	Same as C119	
C184	Same as C104	
C187	Same as C142	
DS101	Lamp, Incandescent	B1110-7
DS102	Same as DS101	
F101	Fuse, Cartridge (230 VAC, $\frac{1}{2}$ Amp)	FU102-.50
F101	Fuse, Cartridge (115 VAC, 1 Amp)	FU102-1.0
F102	Same as F101 (Spare)	
F102	Same as F101 (Spare)	
FL101	Filter	FX287
J116	Connector, Receptacle, Male	MS3102A16S5P
J117	Jack, Telephone	JJ034
J118	Jack, Telephone	JJ033
J120 thru J125	Connector, Receptacle, RF, Female	UG625/U
L101 thru L103	Coil, RF, Fixed, 120 uh, $\pm 10\%$	CL240-120
L104 thru L106	Coil, RF, Fixed, 120 uh, $\pm 10\%$, molded	CL275-121
L107 thru L109	Same as L101	

FMA105

SUB ASSEMBLY

REF SYMBOL	DESCRIPTION	TMC PART NUMBER
L110	Same as L104	
L111	Same as L101	
L113 and L114	Same as L101	
L115	Same as L104	
L116	Same as L101	
L117	Same as L101	
L119 thru L121	Same as L104	
L125	Same as L104	
L126	Same as L104	
L128	Same as L104	
L129	Coil, R.F. Fixed	CL275-8R2
L130 thru L136	Same as L104	
M101	Meter	MR191-9
P305	Connector, Plug, Female	P1204
R101	Resistor, Variable, Composition, 1000 ohms, $\pm 10\%$, $\frac{1}{2}$ watt	RV106UX8B102A
R102A,B	Resistor, Variable, Dual, Composition, Front 1000 ohms, Rear 10000 ohms, $\pm 10\%$, 2 watt	RV108-2
R103	Resistor, Variable, Composition, 100 ohms, $\pm 10\%$ $\frac{1}{2}$ watt	RV4NAYSD101A
R104	Resistor, Variable, Composition, 500000 ohms, $\pm 10\%$	RV100-1
R105	Same as R104	
R107	Res, Var, Comp, 10000 ohms, $\pm 10\%$, $\frac{1}{2}$ watt	RV106UX8B103A

BMA105

SUB ASSEMBLY

REF SYMBOL	DESCRIPTION	TMC PART NUMBER
R108 thru R110	Resistor, Fixed, Wire-Wound, 1 ohm, $\pm 5\%$, .66 watts	RW126-41R0
R111	Resistor, Fixed, Composition, 1000 ohms, $\pm 5\%$, $\frac{1}{4}$ watt	RC07GF102J
R112	Same as R11	
R113	Resistor, Fixed, Composition, 220 ohms, $\pm 5\%$, $\frac{1}{4}$ watt	RC07GF221J
R114	Resistor, Fixed, Composition, 300,000 ohms, $\pm 5\%$, $\frac{1}{4}$ watt	RC07GF304J
R115	Resistor, Fixed, Composition, 47000 ohms, $\pm 5\%$, $\frac{1}{4}$ watt	RC07GF473J
R116	Same as R115	
R117	Same as R111	
R118	Same as R111	
R119	Resistor, Fixed, Composition, 2200 ohms, $\pm 5\%$, $\frac{1}{4}$ watt	RC07GF222J
R120	Resistor, Fixed, Composition, 3900 ohms, $\pm 5\%$, $\frac{1}{4}$ watt	RC07GF392J
R121	Resistor, Fixed, Composition, 100000 ohms, $\pm 5\%$ $\frac{1}{4}$ watt	RC07GF104J
R122	Same as R115	
R123	Resistor, Fixed, Composition, 2700 ohms, $\pm 5\%$, $\frac{1}{4}$ watt	RC07GF272J
R124	Resistor, Fixed, Composition, 150 ohms, $\pm 5\%$, 2 Watt	RC42GF151J
R125	Same as R124	
R126	Resistor, Fixed, Composition, 8200 ohms, $\pm 5\%$, $\frac{1}{4}$ watt	RC07GF822J
R127	Same as R119	
R128	Same as R111	
R130	Resistor, Fixed, Composition, 82 ohms, $\pm 5\%$, $\frac{1}{4}$ watt	RC07GF820J
R131	Resistor, Fixed, Composition, 68 ohms, $\pm 5\%$, $\frac{1}{4}$ watt	RC07GF680J

FMA105

SUB ASSEMBLY

REF SYMBOL	DESCRIPTION	TMC PART NUMBER
R193	Resistor, Fixed, Composition, 10000 ohms, $\pm 5\%$, $\frac{1}{4}$ watt	RC07GF103J
S108	Switch, Toggle, SPDT	ST103-11-62
S109	Same as S108	
S110	Switch, Rotary	SW447
S111	Switch, Rotary	SW446
S112	Switch, Toggle, SPDT	ST22N
S113	Same as S112	
S115	Switch, Rotary	S2445
TB103 thru TB105	Term., Board-Barrier	TM100-6
XDS101	Light, Indicator, White Lens	TS153-5
XDS102	Light, Indicator, Red Lens	TS153-1
XF101	Fuse Holder	FH104-3
XF102	Same as XF101	
Z305	Heat, Sink, Assembly	BMA173

BMA-173

REF SYMBOL	DESCRIPTION	TMC PART NUMBER
P306	CONN, RECP, MALE	PL225-8P
Q301	TRANSISTOR, SILICON, NPN	2N1488
Q302	Same as Q301	
Q303	Same as Q301	

AX-676

CHASSIS, ASSEMBLY MAIN

REF SYMBOL	DESCRIPTION	TMC PART NUMBER
J101	Connector, Receptacle, Female	JJ319A15DFE
J102	Same as J101	
J103	Same as J101	
J104	Same as J101	
J105	Same as J101	
J106	Same as J101	
J107	Same as J101	
J108	Same as J101	
J109	Same as J101	
J110	Same as J101	
J111	Same as J101	
J112	Same as J101	
J113	Same as J101	
J114	Same as J101	
J115	Same as J101	

A-4592

RESISTOR BOARD ASSEMBLY

REF SYMBOL	DESCRIPTION	TMC PART NUMBER
R129	Resistor, Fixed, Composition, 100 ohms, ±5%, ½ Watt	RC07GF101J
R130	Resistor, Fixed, Composition, 470 ohms, ±5%, ½ Watt	RC07GF471J
R132 thru R135	Same as R130	
R138 thru R142	Same as R130	
R144 thru R148	Same as R130	
R150 thru R154	Same as R130	
R156 thru R160	Same as R130	

A-4593

RESISTOR BOARD ASSEMBLY

REF SYMBOL	DESCRIPTION	TMC PART NUMBER
R161	Resistor, Fixed Composition, 100 ohms, $\pm 5\%$, $\frac{1}{4}$ Watt	RC07GF101J
R162	Resistor, Fixed Composition, 470 ohms, $\pm 5\%$, $\frac{1}{4}$ Watt	RC07GF471J
R164 thru R168	Same as R162	
R170 thru R174	Same as R162	
R176 thru R180	Same as R162	
R182 thru R186	Same as R162	
R188 thru R192	Same as R162	

