

CHAN E NO. 002 EMN 21998



## INSTRUCTION BOOK CHANGE NOTICE

Date 2-1-83

Manual affected: HFLM-1KA

IN 202-2116-002

PAGE 6-3 HFLM-1KA

A103R5 CHANGED FROM RW105-32 TO RW105-35

A103R6 CHANGED FROM RW105-32 TO RW105-35

PAGE 7-3

SCHEMATIC DIAGRAM  
HIGH VOLTAGE POWER SUPPLY AP152

CHANGE ON A5637 A103

R5 CHANGED FROM 15K TO 30K

R6 CHANGED FROM 15K TO 30K

AP152 H/V Power Supply (con't)

REF SYMBOL	DESCRIPTION	TMC PART NUMBER
A-4853-6 Assembly, Board, PC Rect		
A101CR1 thru A101CR4	Rect, Scnd, Dev	DD140
A101R1	Resistor, Fixed, WW 10W	RW109-4
A101R2	Same as A101R1	
A101R3	Resistor, Fixed, WW 20W	RW110-3
A-4853-7 Assembly, Board, PC Rect		
A102CR1 thru A102CR4	Rect, Scnd, Dev	DD140
A102R1	Resistor, Fixed, WW 10W	RW109-4
A102R2	Same as A102R1	
A102R3	Resistor, Fixed, WW 20W	RW110-7
A5637 Assembly, Board, PC Zener		
A103CR1	Scnd, Dev, Dio	1N2846A
A103CR2	Same as A103CR1	
A103R1	Resistor, Fixed, Comp	RC42GF274J
A103R2	Resistor, Fixed, Comp	RC42GF124J
A103R3	Resistor, Fixed, Comp	RC42GF101J
A103R4	Resistor, Fixed WW 50W	RW105-35
A103R5	SAME AS A103R4	
A103R6	Same As A103R 4	
A103R8	Same As A103R3	
A103R9	Same as A103R3	

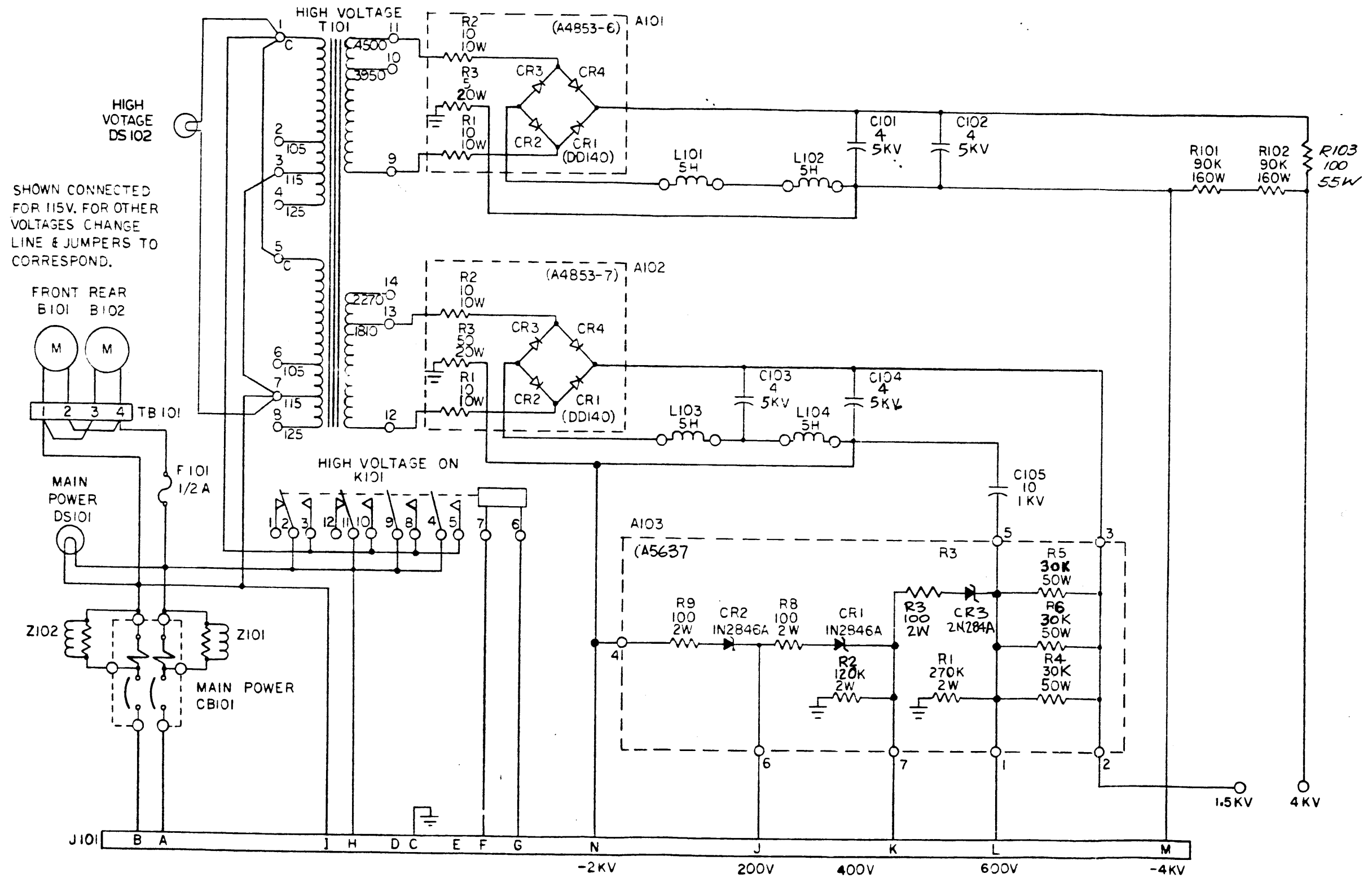

Schematic Diagram,  
High Voltage Power Supply AP152

(CK1869 )

CHANGE NO. 001 EMN 21933



## INSTRUCTION BOOK CHANGE NOTICE

Date 3/15/82

Manual affected: HFLM-1KA IN 120-2116

Assembly A5637 (A103) AP152  
RW105-32 Changed from 3 to 2 req. (R5, R6)  
RW105-35 Changed from RW105-32 (R4)  
Pages effected 7-3, 6-3

Assembly A4879 (A1001) TLAM-1KA  
(R21) 22K  $\frac{1}{2}$ W Resistor changed from 470K  $\frac{1}{2}$ W Resistor  
(R22) 560 ohm  $\frac{1}{4}$ W Resistor changed from 5.6K  $\frac{1}{4}$ W Resistor  
(R10) 560 ohm  $\frac{1}{2}$ W Resistor changed from 120 ohm  $\frac{1}{2}$ W Resistor  
Pages effected 7-4, 6-14

Assembly A4877 (A301) AP151  
(R11) 10K 2W Resistor changed from 12K 2W Resistor  
Pages effected 7-2, 6-6

SHOULD ADDITIONAL COPIES OF THIS CHANGE NOTICE BE REQUIRED, PLEASE CONTACT:

THE TECHNICAL MATERIEL CORP., 700 Fenimore Road, Mamaroneck, New York

Attn.: Director of Eng. Services.

### NOTE

Refer to the supplied equipment packing list to locate the appropriate crates containing the components, hardware and units outlined in the following steps.

#### STEP 1

- a. Unpack assorted LOOSE ITEMS from crate.
- b. Check each item contained against equipment supplied list.

#### STEP 2

- a. Unpack cabinet from crate, if supplied.
- b. Position cabinet upright (power supply grill located on lower portion of cabinet front indicates upright position), and remove rear panel as necessary (dependent upon equipment cabinet selection). The removal of rear panels on TMC furnished equipment cabinets can be accomplished by turning the screw fastener located at the left and right of the rear panel.
- c. Remove all packing material from cabinet and position cabinet in accordance with pre-installation planning.

### WARNING

INSURE THAT PRIMARY POWER EXTERNAL TO THIS EQUIPMENT IS OFF AND TAGGED.

#### STEP 3 (Primary AC Input Connection)

- a. Route ac input cable to base assembly and connect to PWR INPUT terminal strip TB2001. (On some models ac input connects to jack J2001).

#### STEP 4 (Installation of Power Amplifier Tube, 8576)

- a. Remove the top cover from the TLAM-1KA.
- b. Carefully lift power amplifier tube from crate and position it on top of the PA tube socket in the TLAM-1KA.
- c. Position tube to line up with PA tube socket contacts.
- d. Carefully lower tube straight down into socket until slight resistance is encountered. Make sure that tube is centered in socket.
- e. Press tube firmly down into socket. A slight amount of effort may be required to seat tube. Caution should be observed in seating the tube so as not to damage contacts in socket. Check tube seating; it must be all the way down and centered in tube socket.
- f. Tighten retaining strap so that tube is held securely in place.

AP152 H/V Power Supply (con't)

REF SYMBOL	DESCRIPTION	TMC PART NUMBER
	<b>A-4853-6 Assembly, Board, PC Rect</b>	
A101CR1 thru A101CR4	Rect, Scond, Dev	DD140
A101R1	Resistor, Fixed, WW 10W	RW109-4
A101R2	Same as A101R1	
A101R3	Resistor, Fixed, WW 20W	RW110-3
	<b>A-4853-7 Assembly, Board, PC Rect</b>	
A102CR1 thru A102CR4	Rect, Scond, Dev	DD140
A102R1	Resistor, Fixed, WW 10W	RW109-4
A102R2	Same as A102R1	.
A102R3	Resistor, Fixed, WW 20W	RW110-7
	<b>A5637 Assembly, Board, PC Zener</b>	
A103CR1	Scond, Dev, Dio	1N2846A
A103CR2	Same as A103CR1	
A103R1	Resistor, Fixed, Comp	RC42GF274J
A103R2	Resistor, Fixed, Comp	RC42GF124J
A103R3	Resistor, Fixed, Comp	RC42GF101J
A103R4	Resistor, Fixed WW 50W	RW105-35
A103R5	Resistor, Fixed WW 50W	RW105-32
A103R6	Same As A103R5	
A103R8	Same As A103R3	
A103R9	Same as A103R3	

A-4877 Board, Assembly, PC Bias

REF SYMBOL	DESCRIPTION	TMC PART NUMBER
CR1	Rect, Scond, Dev	DD130-600-1.5
CR2	Scond, Dev, Dio	1N645
CR3 thru CR10	Same as CR2	
K1	Rel, Arm 4PDT	RL156-15
K2	Rel, Arm 4PDT	RL156-10
R1	Res, Fxd, Comp	RC42GF100J
R2	Same as R1	
R3	Res, Fxd, Comp	RC42GF122J
R4	Res, Var, Comp	RV4LAYS252A
R5	Res, Fxd, Comp	RC42GF101J
R6	Res, Fxd, Comp	RC42GF332J
R7	Res, Var, Comp	RV4LAYS502A
R8	Res, Fxd, Comp	RC42GF151J
R9	Res, Fxd, Comp	RC42GF472J
R10	Res, Var, Comp	RV4LAYS103A
R11	Res, Fxd, Comp	RC42GF103J
R12	Res, Fxd, Comp	RC32GF122J
R13	Res, Fxd, Comp	RC32GF152J
R14	Same as R12	
R15	Same as R13	
XK1	Soc, Re1	TS171-4
XK2	Same as XK1	

A-4879 Printed Circuit Board Assembly (con't)

REF SYMBOL	DESCRIPTION	TMC PART NUMBER
Q3	Same as Q2	
R1	Resistor, Var, Comp	RV111U502A
R2	Resistor, Var, Comp	RV111U103A
R3	Resistor, Fixed, Comp	RC20GF152J
R4	Resistor, Fixed, Comp	RC20GF102J
R5	Resistor, Fixed, Comp	RC20GF153J
R6	Resistor, Fixed, Comp	RC20GF391J
R7	Same as R6	
R8	Same as R4	
R9	Resistor, Fixed, Comp	RC20GF821J
R10	Resistor, Fixed, Comp	RC20GF560J
R11	Resistor, Fixed, Comp	RC20GF122J
R12	Not used	
R13	Not used	
R14	Not used	
R15	Not used	
R16	Not used	
R17	Not Used	
R18	Not Used	
R19	Not Used	
R20	Resistor, Fixed, Comp	RC20GF224J
R21	Resistor, Fixed, Comp	RC20GF223J
R22	Resistor, Fixed, Comp	RC07GF561J
Z1	Network, OP Amp	NW156



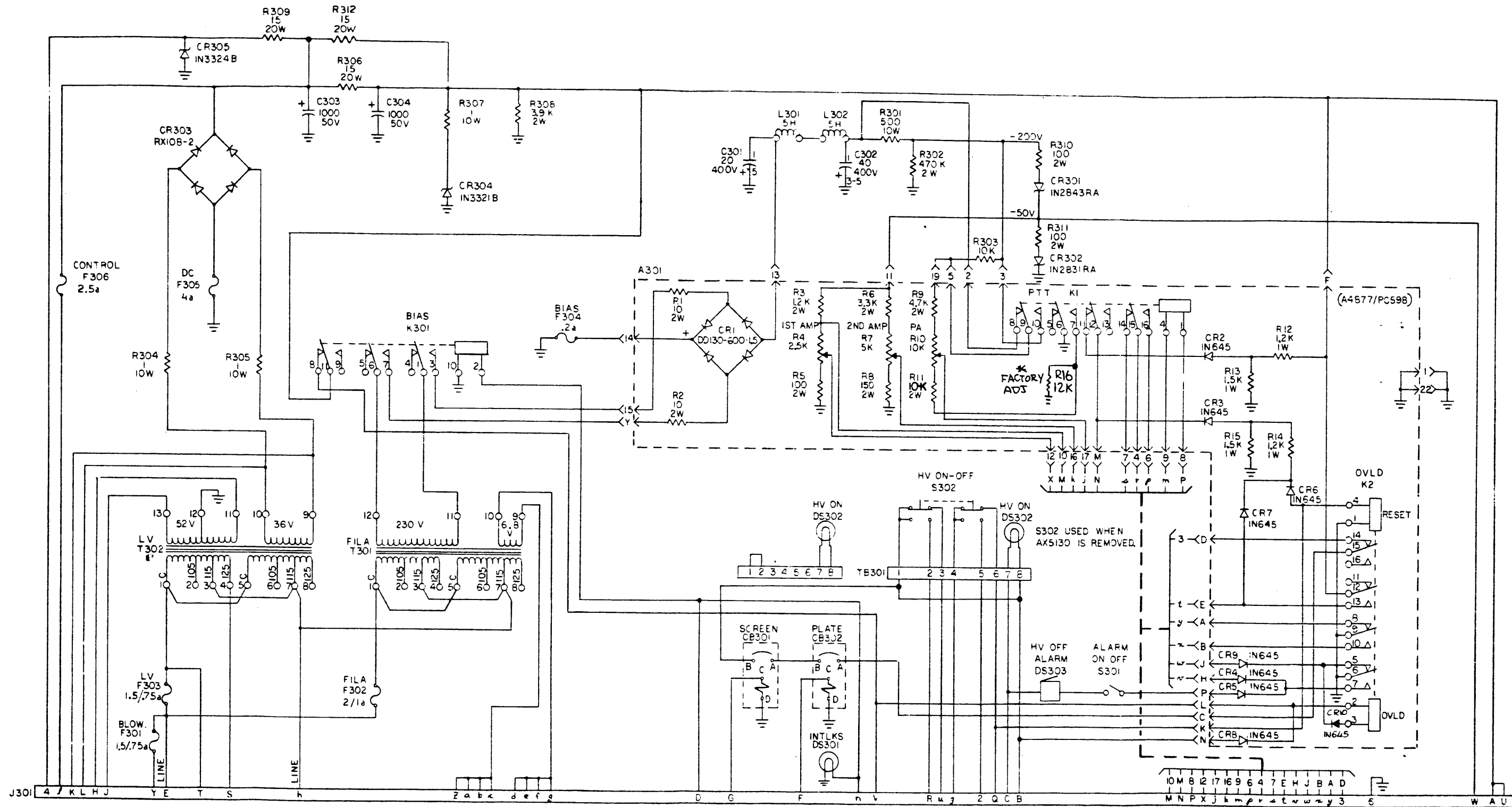

- UNLESS OTHERWISE SPECIFIED:
1. ALL RESISTANCES ARE IN OHMS,  $\frac{1}{2}$  W.
  2. ALL CAPACITANCES ARE IN MFD.
  3. ALL INDUCTANCES ARE IN H.
  4. AC FUSE VALUES SHOWN FOR 115/230 V OPERATION.
  5. TRANSFORMERS SHOWN WIRED FOR 115 V. FOR OTHER VOLTAGES CHANGE LINE # JUMPERS TO CORRESPOND.
  6. PARTIAL REFERENCE DESIGNATIONS ARE SHOWN, FOR COMPLETE DESIGNATION PREFIX THE PART DESIGNATION WITH THE SUB-ASSEMBLY DESIGNATION.

Schematic Diagram,  
Low Voltage and Bias Supply AP151

(CK1870-F)

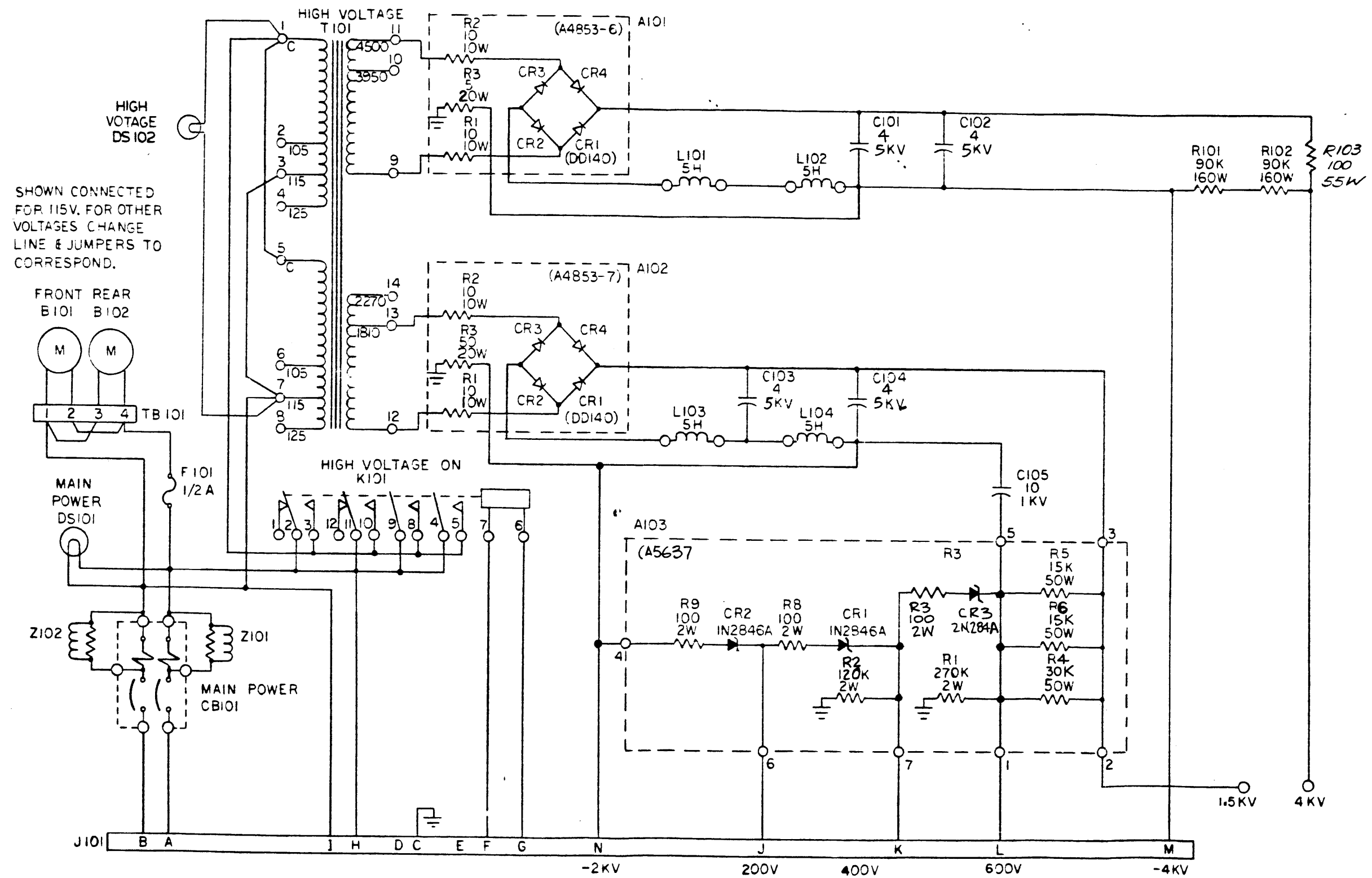

Schematic Diagram,  
High Voltage Power Supply AP152

(CK1869-J)

J1003 TB1101 24 VDC

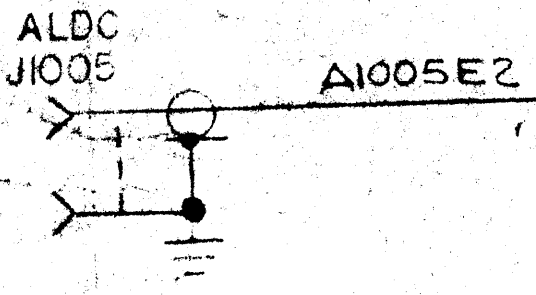
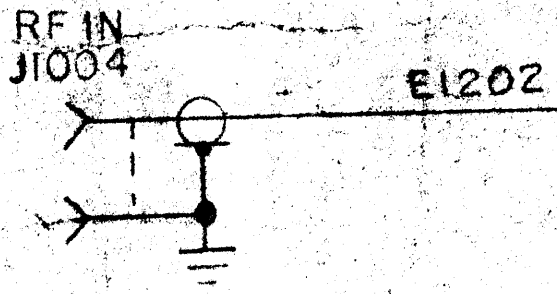
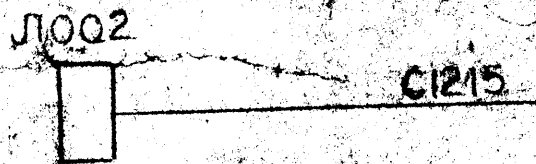
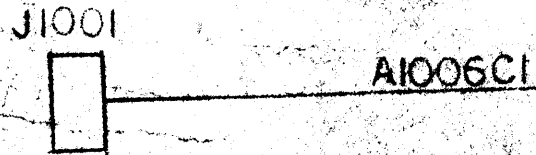
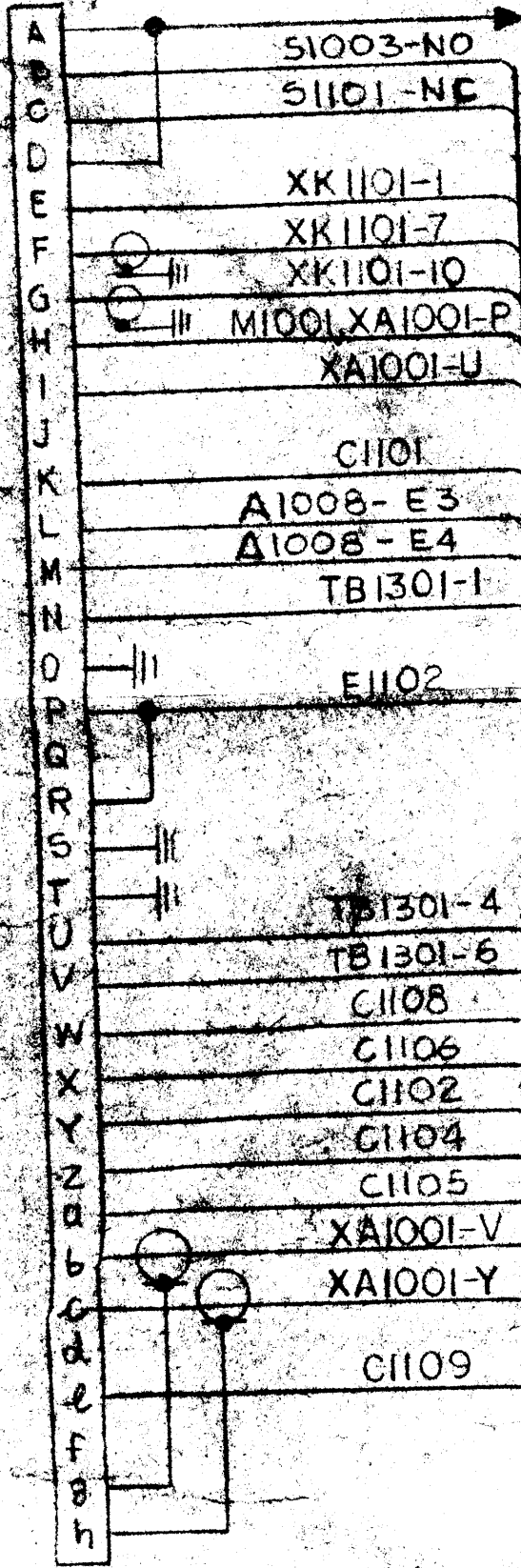

J1007 XK1101-5

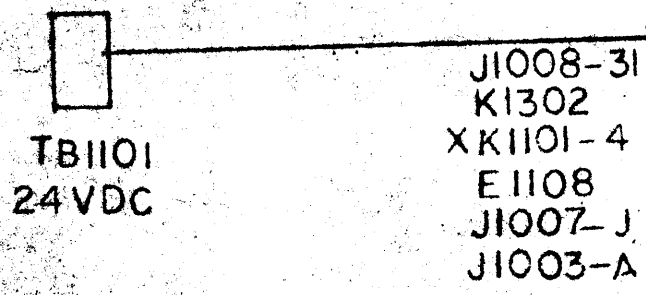
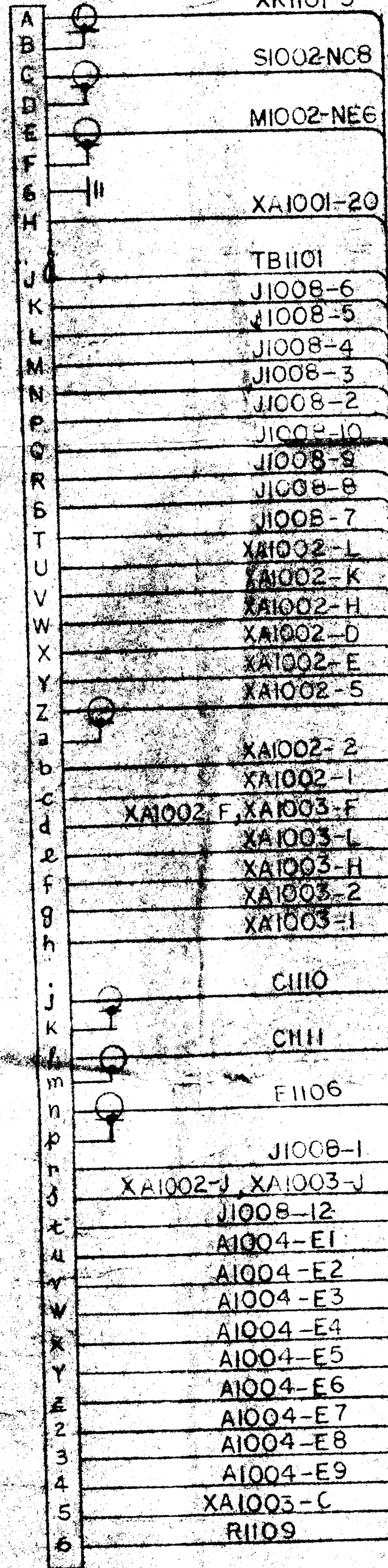

1101-5  
 002-NC8  
 002-NEG  
 001-20  
 1101  
 008-6  
 008-5  
 008-4  
 008-3  
 008-2  
 008-10  
 008-9  
 008-8  
 008-7  
 002-L  
 002-K  
 002-H  
 002-D  
 002-E  
 002-5  
 002-2  
 002-1  
 003-F  
 003-L  
 003-H  
 003-2  
 003-1  
 110  
 111  
 1106  
 008-1  
 003-J  
 -12  
 -E1  
 -E2  
 -E3  
 -E4  
 -E5  
 -E6  
 -E7  
 -E8  
 -E9  
 -C  
 J1008-31  
 K1302  
 K1101-4  
 E1108  
 J1007

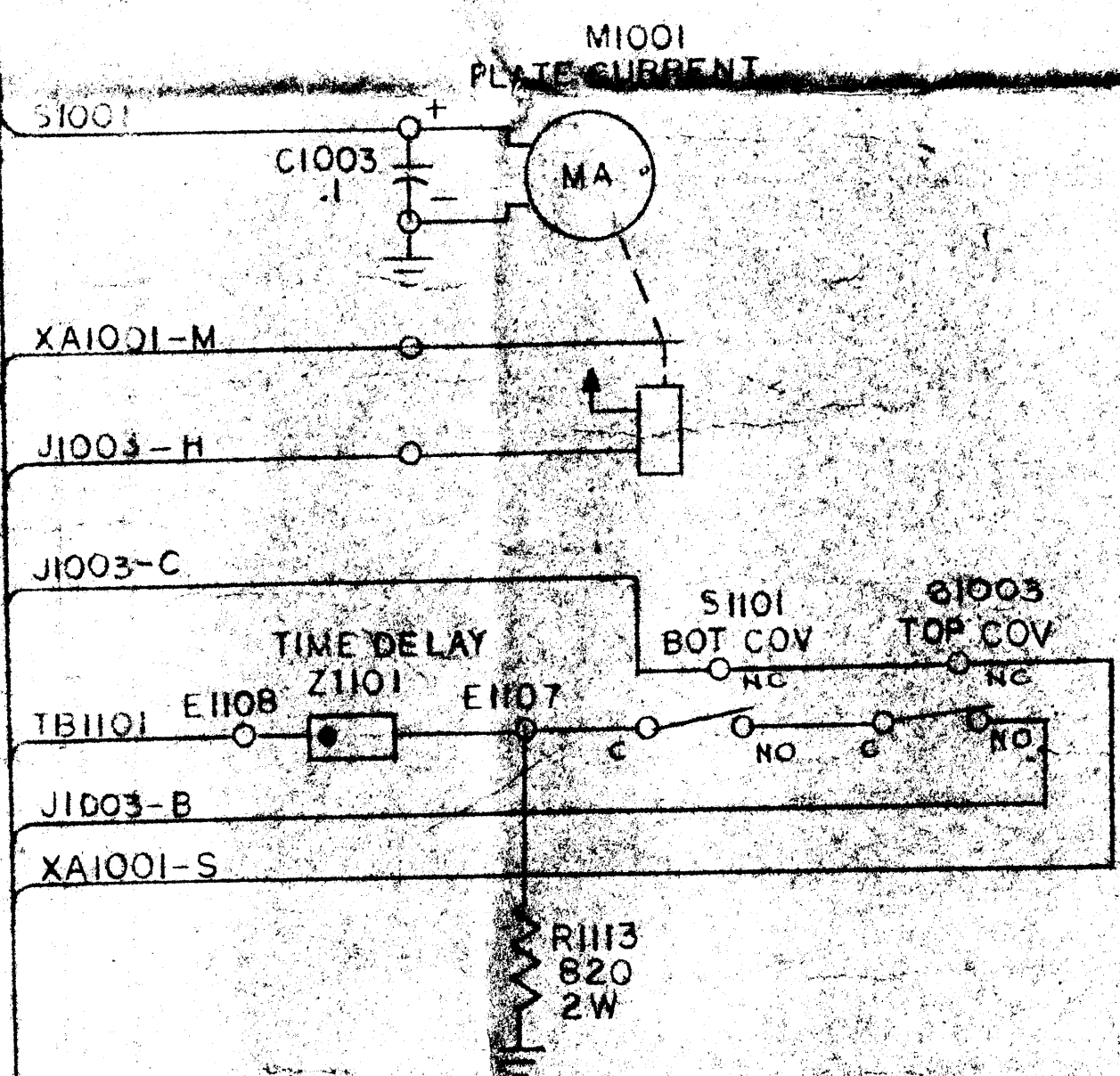
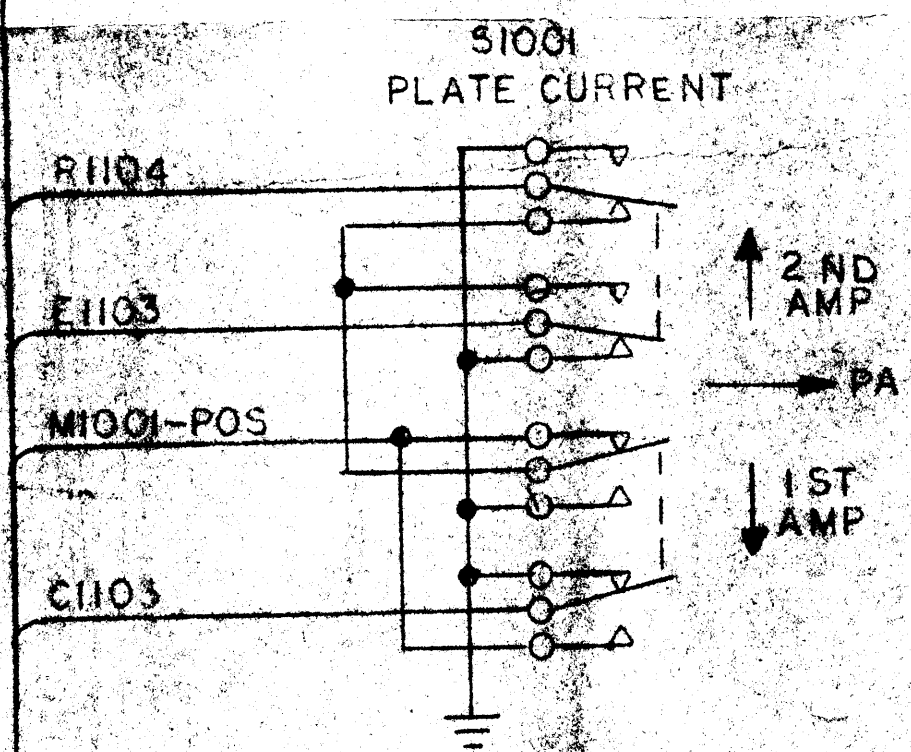
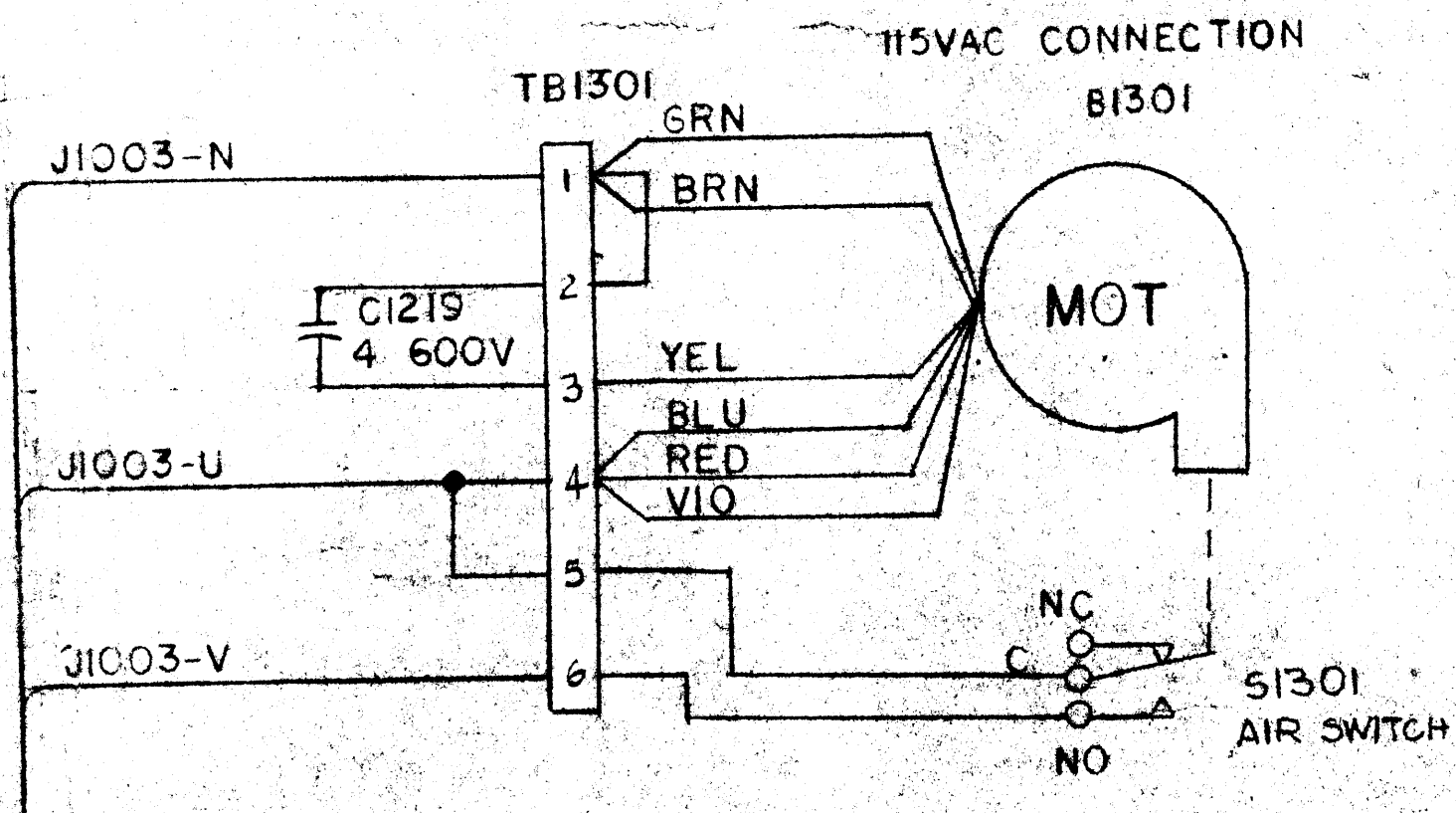

S1002  
 XA1001  
 J1003  
 J1007  
 XA1001  
 J1003  
 J1003  
 TB1301  
 J100  
 XK1101  
 C1101  
 5  
 J100  
 XA1001  
 XA1001

CONNECTION

B1301

MOT

S1301  
AIR SWITCH

230 VAC CONNECTION

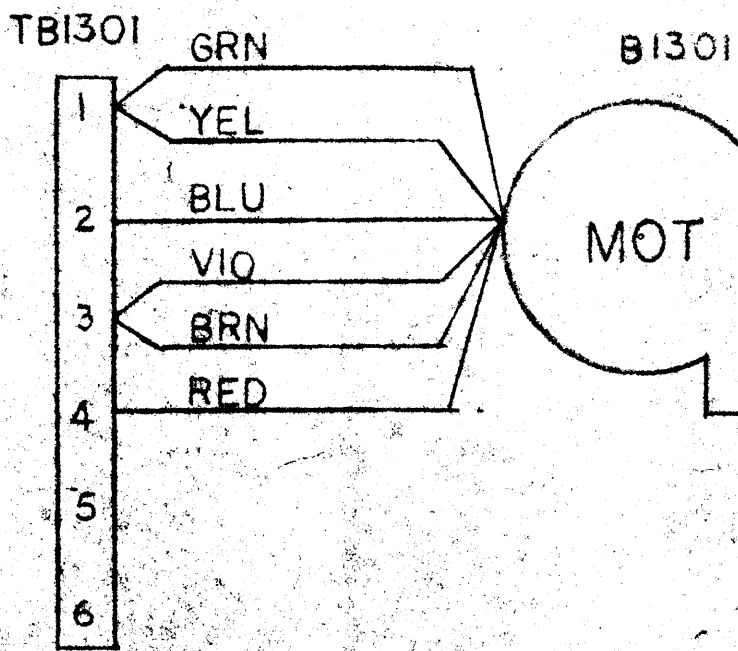

\*\*\* ONE PAIR OF LEADS ONLY IS USED. IF TFP-1K IS USED IN SYSTEM, DC1001 IS REMOVED, UNUSED PAIR IS TIED BACK.

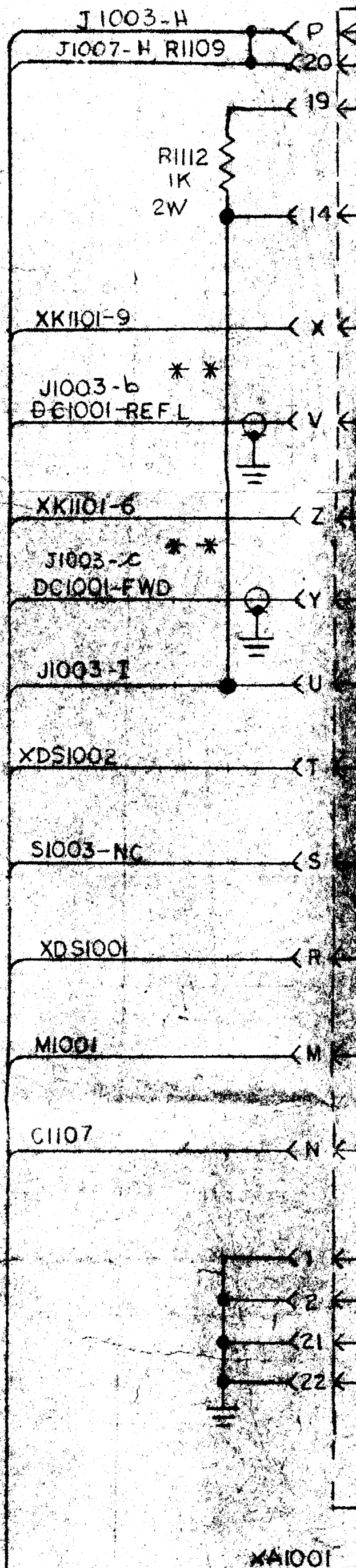
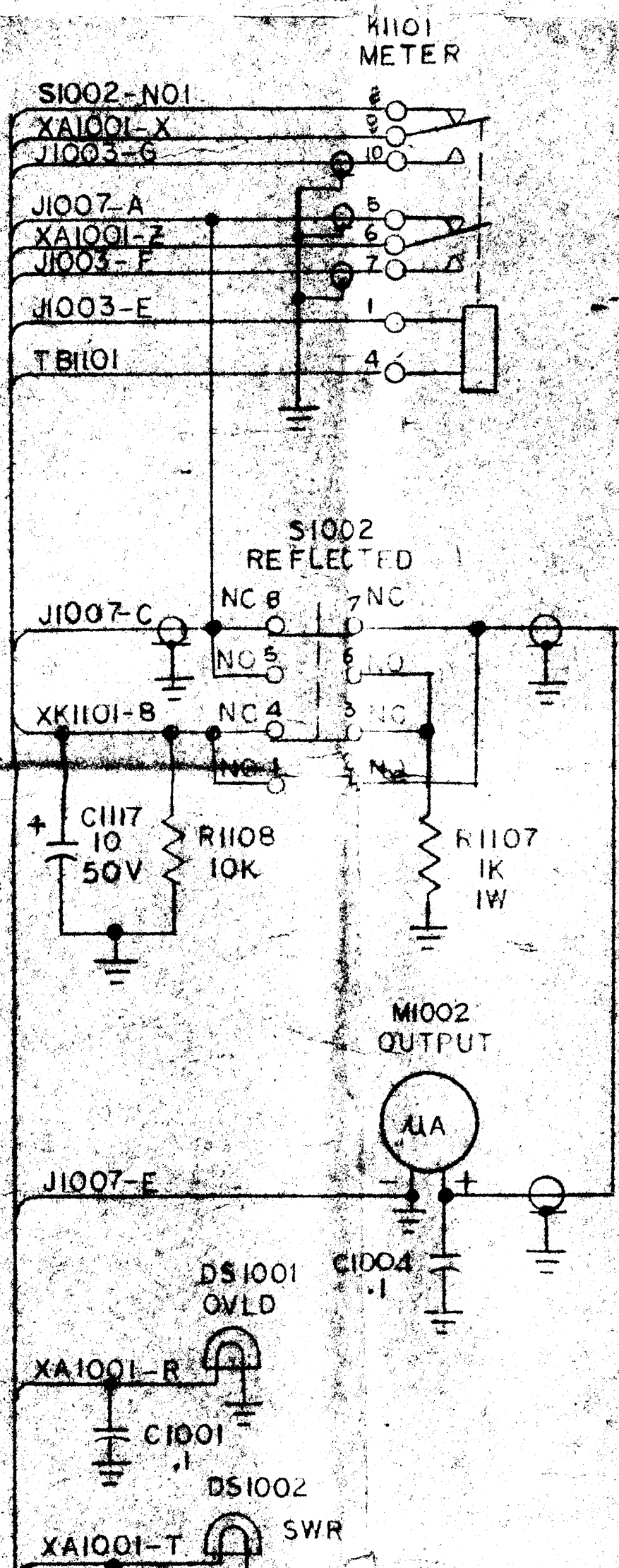

A1001 OVL D

(A487)

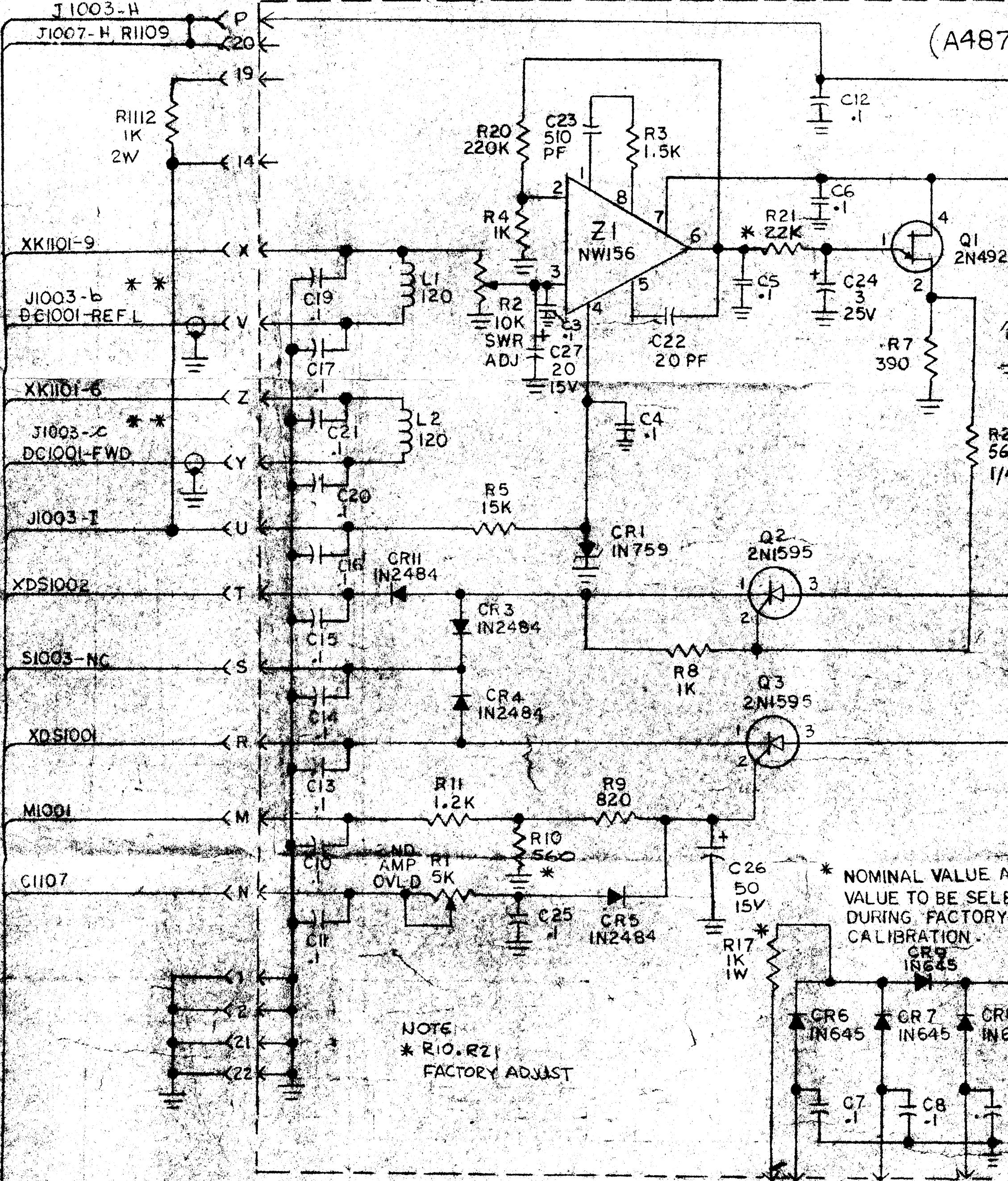

\* NOMINAL VALUE AND VALUE TO BE SELECTED DURING FACTORY CALIBRATION.

NOTE  
\* R10, R21  
FACTORY ADJUST

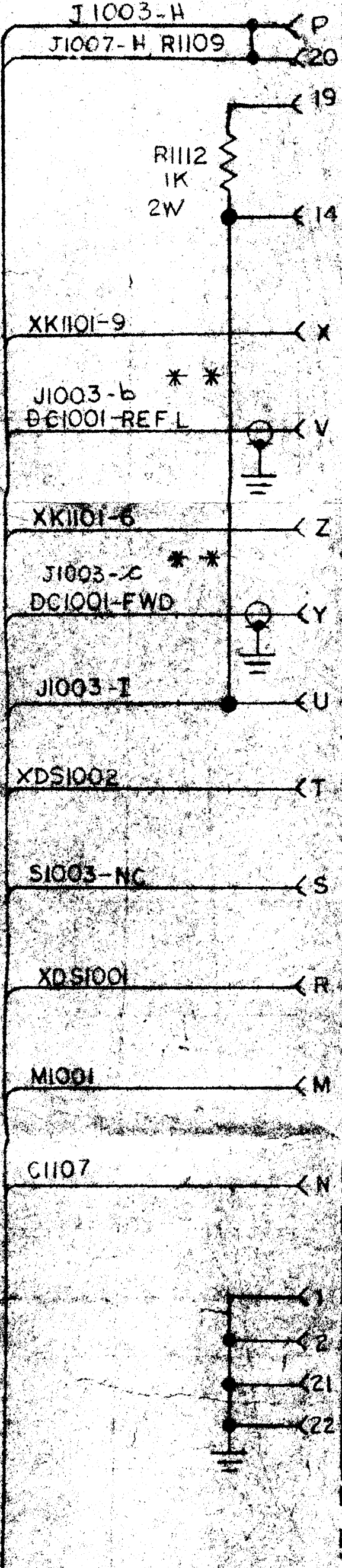

XA1001

1008 TERM. 3  
1008-20  
008-19  
1008-18

(A4879/PC600)

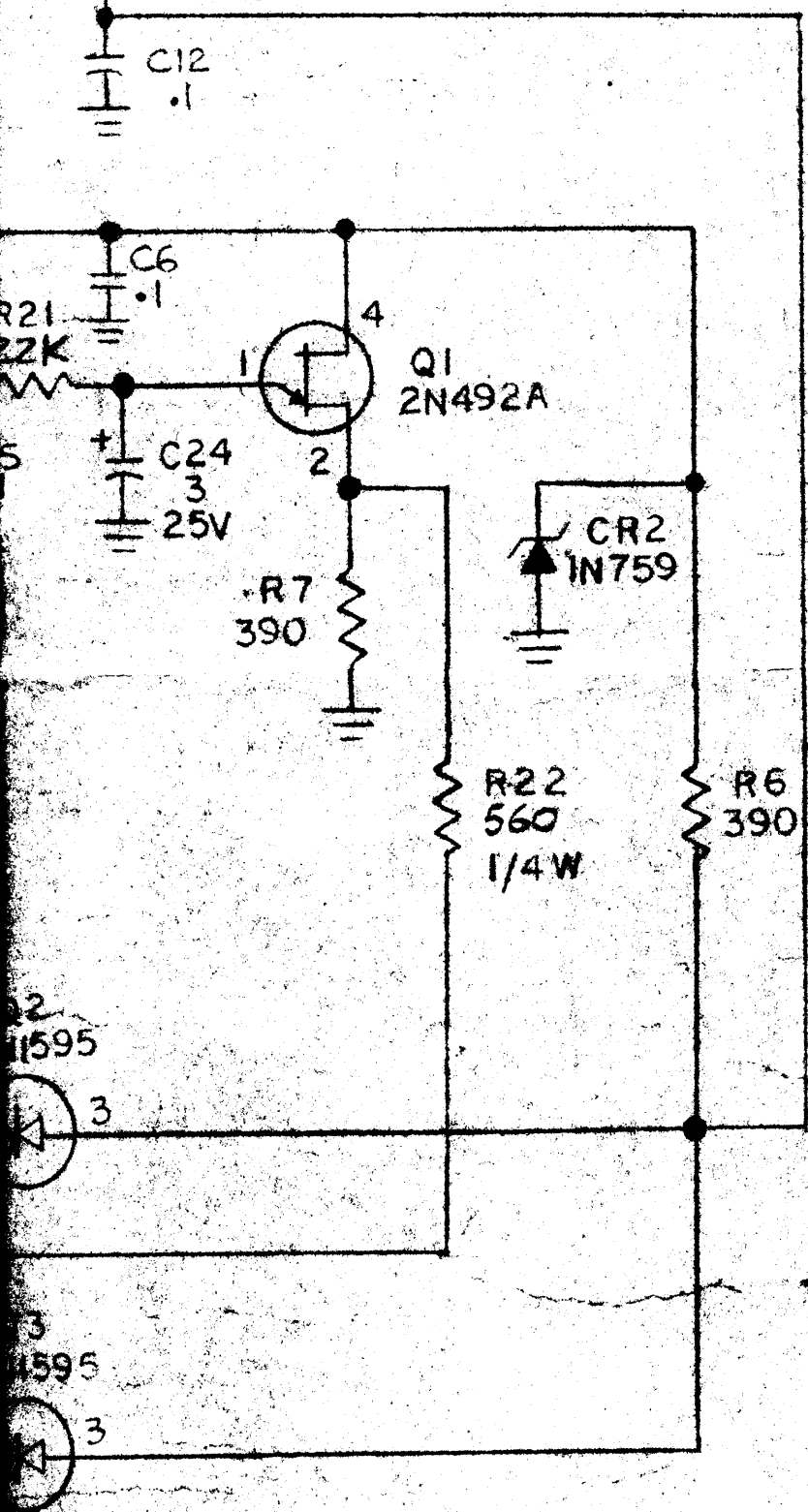

\* NOMINAL VALUE ACTUAL VALUE TO BE SELECTED DURING FACTORY CALIBRATION.

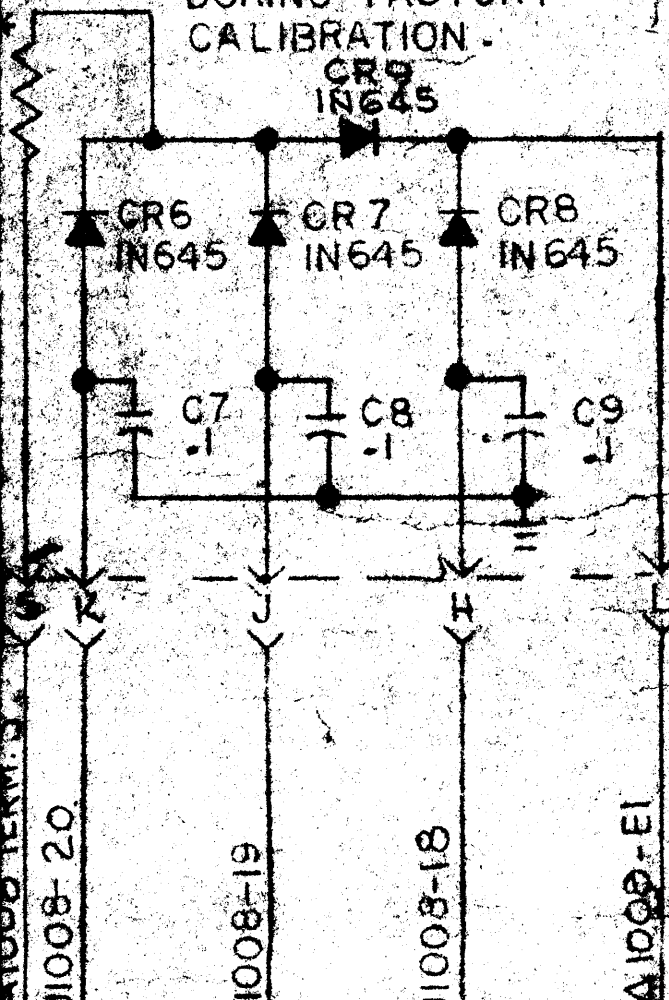





E1106  
 J1008-1  
 XA1003-J  
 008-12  
 004-E1  
 004-E2  
 004-E3  
 004-E4  
 004-E5  
 004-E6  
 004-E7  
 004-E8  
 004-E9  
 005-C  
 109  
 J1008-31  
 K1302  
 XK1101-4  
 E1108  
 J1007-J  
 J1003-A

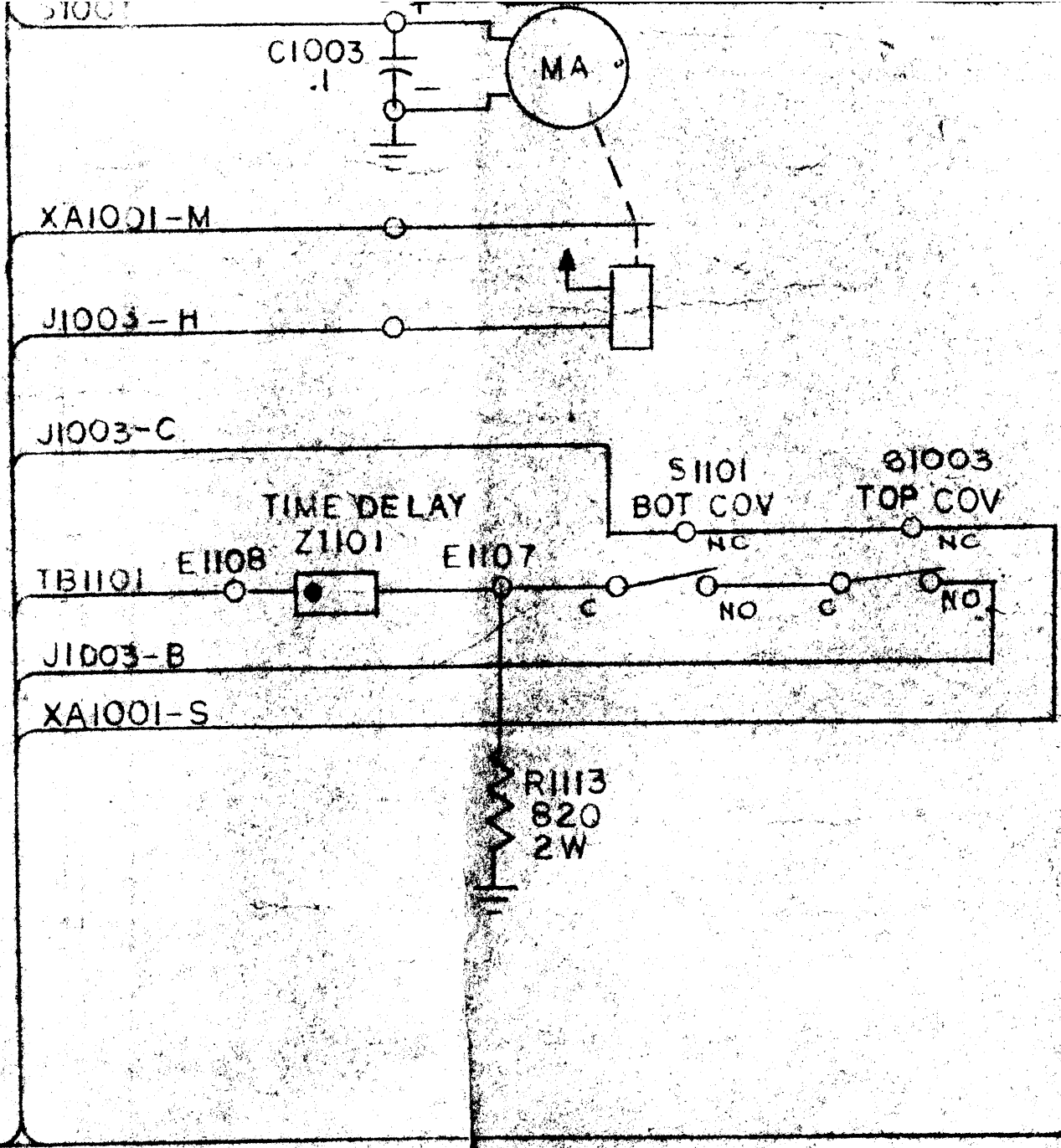

A1002A1 A1003A1		A1004		A1005		A1006		A1400		1100	
LAST	MISSING	LAST	MISSING	LAST	MISSING	LAST	MISSING	LAST	MISSING	LAST	MISSING
		C9		C3		C		C2		C117	
		CR9		CR1		C				E1108	
		DS9		R2		B				K1101	
		E10				H				R1113	
		RI				U				S1101	
						P				TB1101	
						S				XK1101	
						X				Z1101	

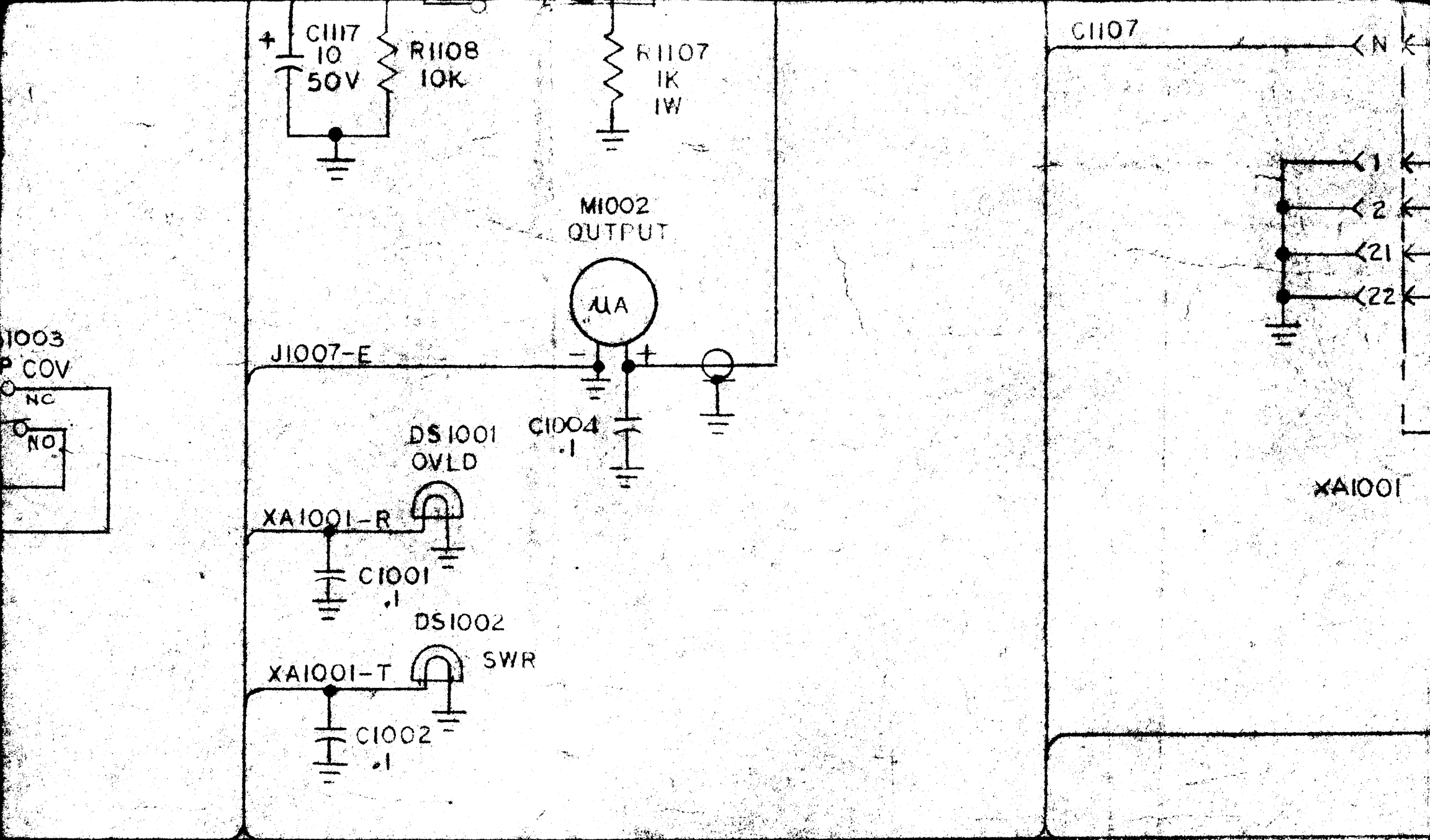

MISSING	1100		1200		1300		A1008	
	LAST	MISSING	LAST	MISSING	LAST	MISSING	LAST	MISSING
	C1117	C1113, 1115 C1114	C1220 E1208		B1301 C1323 E1302	C1301, 2, 4, 5, 6 C1316-C1321	C7 CRA EA K3 L1 R1	
	E1108 K1101 R1113 S1101 TB1101 XK1101 Z1101	E1105, 1106 E1101 R1106	L1207 R1214 T1201 V1202 XV1202 Z1202	L1201	L1307 R1302 S1301 TB1301 V1301 XV1301	K1301, K1302 R1301 T1301		

A1001	A

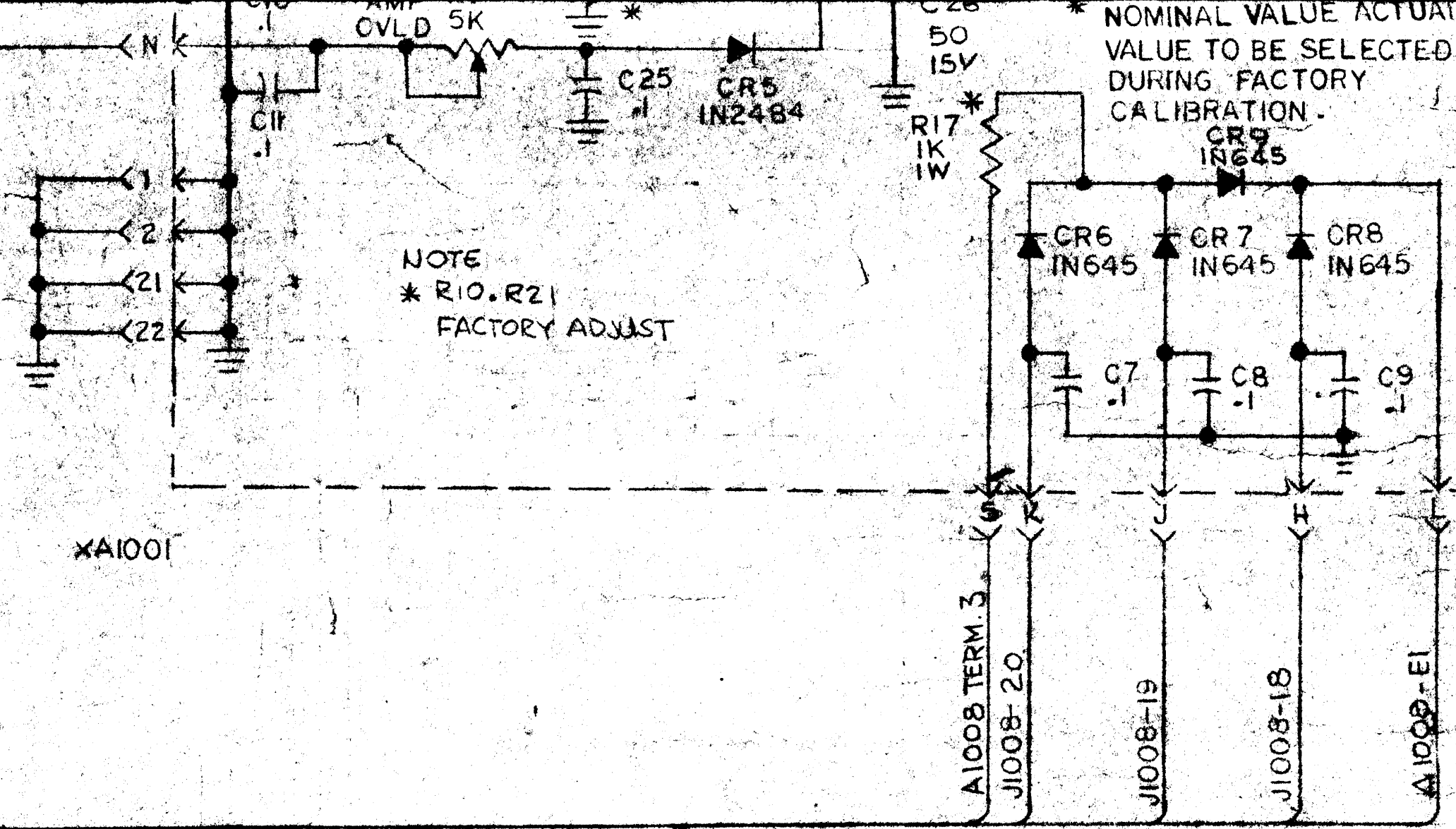

A1001	A	R21 was 100K R22 was 5.6K	3-28-62	2/931	880

QTY.	REV.	ITEM
FINAL J1008		
MESH. DES.		
ELECT. DES.		
CHECKED		
DRAWN		
G. B.		



TABLE OF CONTENTS

Appendix B

Paragraph		Page
	SECTION 1 - GENERAL INFORMATION	
1-1	Functional Description . . . . .	1-1
1-2	Physical Description . . . . .	1-1
1-3	Reference Data . . . . .	1-2
	SECTION 2 - INSTALLATION	
2-1	Initial Unpacking and Inspection . . . . .	2-1
2-2	Power Requirements . . . . .	2-1
2-3	Installation Procedures . . . . .	2-1
2-4	Pre-Operational Checkout Procedure . . . . .	2-6
	SECTION 4 - PRINCIPLES OF OPERATION	
4-1	General. . . . .	4-1
4-2	Block Diagram Analysis . . . . .	4-1
4-3	AC Power Distribution . . . . .	4-3
4-4	DC Power Distribution . . . . .	4-5
4-5	Protective Interlocks and Overloads . . . . .	4-8
4-6	ALDC . . . . .	4-10
	SECTION 5 - MAINTENANCE	
5-1	Introduction . . . . .	5-1
5-2	List of Test Equipment Required . . . . .	5-1
5-3	Operator's Maintenance Procedure . . . . .	5-1
5-4	Preventive Maintenance . . . . .	5-1
5-5	Troubleshooting . . . . .	5-2
5-6	ALDC Adjustment Procedure . . . . .	5-5
5-7	Transmitter Bias Adjustment Procedure . . . . .	5-6
5-8	Overload Circuit Test . . . . .	5-7
5-9	PA Plate Overload Adjustment . . . . .	5-7
5-10	2nd Amplifier Plate Overload Adjustment . . . . .	5-8
5-11	SWR Overload Adjustment . . . . .	5-9
	SECTION 6 - PARTS LIST	
6-1	Introduction . . . . .	6-1
	SECTION 7 - MAINTENANCE DIAGRAMS	
7-1	General. . . . .	7-1

## LIST OF ILLUSTRATIONS

Figure		Page
SECTION 1 - GENERAL INFORMATION		
1-1	High Frequency Linear Power Amplifier, HFLM-1KA . . . . .	1-0
SECTION 2 - INSTALLATION		
2-1	Typical HFLM-1KA Installation . . . . .	2-3
2-2	Slide-Mounting Details. . . . .	2-5
SECTION 4 - PRINCIPLES OF OPERATING		
4-1	Block Diagram, HFLM-1KA . . . . .	4-2
4-2	AC Power Distribution . . . . .	4-4
4-3	HFLM-1KA Operating Potentials . . . . .	4-6
4-4	Simplified Bias Control . . . . .	4-7
4-5	Simplified Interlock & HV Overload Circuits . . . . .	4-9
4-6	Simplified ALDC Circuit . . . . .	4-10
SECTION 5 - MAINTENANCE		
5-1	Fuse Location Drawing . . . . .	5-4
5-2	VSWR Nomograph. . . . .	5-10
5-3	AP-152 Top View . . . . .	5-11
5-4	AP-151 Top View . . . . .	5-12
5-5	TLAM-1KA. . . . .	5-13
5-6	TLAM-1KA Bottom View . . . . .	5-14
SECTION 7 - MAINTENANCE DIAGRAMS		
7-1	AP151 Schematic Diagram . . . . .	7-2
7-2	AP152 Schematic Diagram . . . . .	7-3
7-3	TLAM-1KA Schematic Diagram . . . . . (3 sheets)	7-4

LIST OF TABLES

Table		Page
	SECTION 1 - GENERAL INFORMATION	
1-1	Major Components . . . . .	1-1
1-2	Technical Specifications . . . . .	1-2
	SECTION 2 - INSTALLATION	
2-1	Pre-Operational Checkout Procedure . . . . .	2-7
	SECTION 5 - MAINTENANCE	
5-1	Operator's Troubleshooting Chart . . . . .	5-3
5-2	Fuse Functions . . . . .	5-5
5-3	Tube Quiescent Current Values . . . . .	5-6

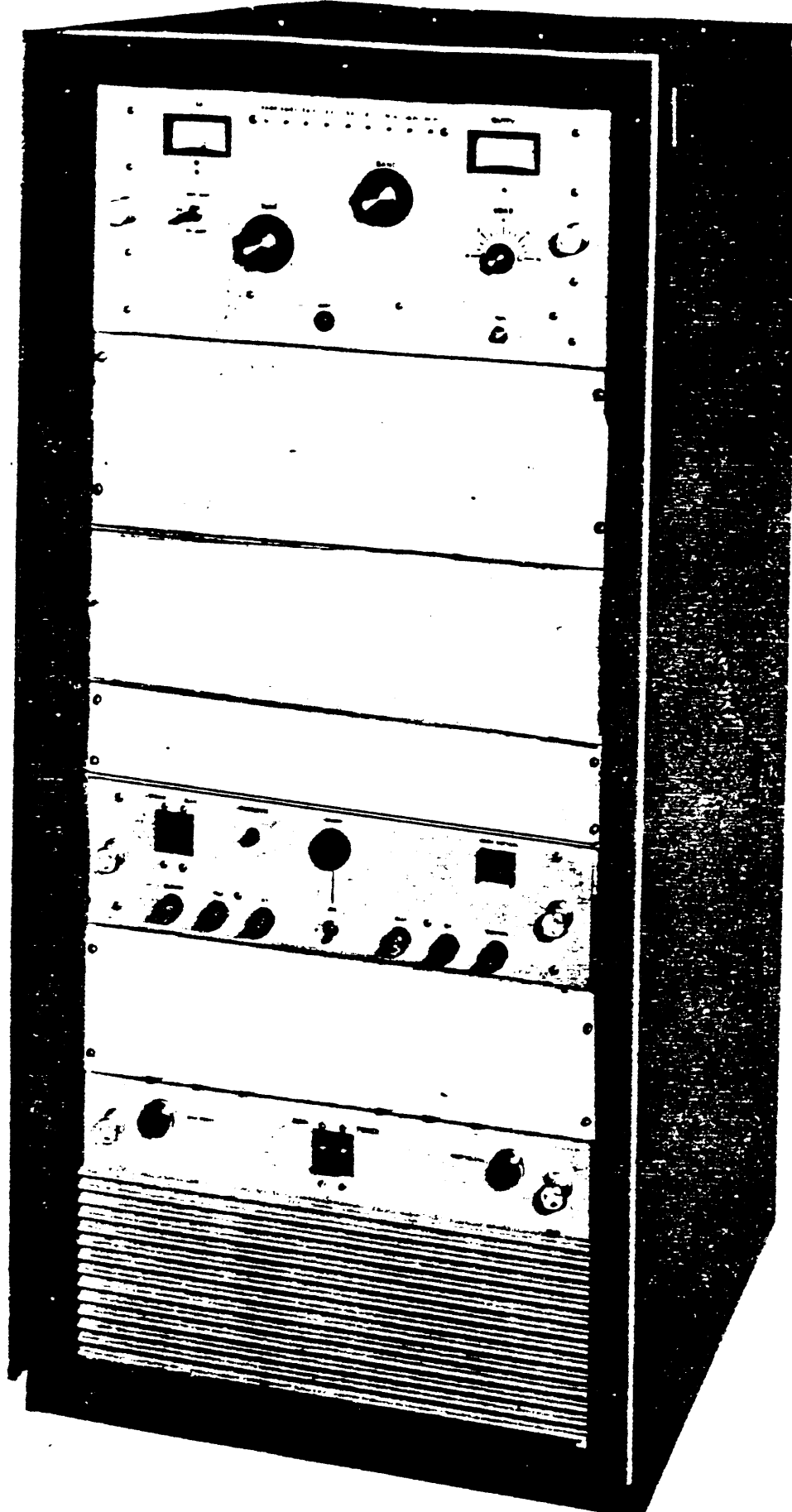

Figure 1-1. High Frequency Linear Power Amplifier HFLM-1KA



## SECTION 1

### GENERAL INFORMATION

#### 1-1. FUNCTIONAL DESCRIPTION

The TMC Model HFLM-1KA (figure 1-1) is a manually tuned, high frequency linear power amplifier and when used with a suitable exciter provides 1 kilowatt PEP or average power throughout the frequency range of 2.0 MHz to 30 MHz.

This linear amplifier, along with a suitable exciter, may be used as the prime source of HF communication, or as part of an existing transmitting system. The small size and light weight of the HFLM-1KA makes it readily adaptable for shipboard, aircraft and land installations.

#### 1-2. PHYSICAL DESCRIPTION

##### a. General

As shown in figure 1-1, the HFLM-1KA consists of a single equipment cabinet, housing all of the components that make up the HFLM-1KA. Table 1-1 lists the major components of the HFLM-1KA as they appear in figure 1-1. The HFLM-1KA houses a two-stage broad band linear amplifier, power amplifier, and associated power supplies. Provisions are made to install optional equipments, such as an exciter, antenna tuner and/or a harmonic filter, switchable or fixed.

TABLE 1-1. MAJOR COMPONENTS

<u>TMC Designation</u>	<u>Nomenclature</u>
RF Linear Power Amplifier	TLAM-1KA
Low Voltage and Bias Supply Drawer	AP-151
High Voltage Power Supply	AP-152

##### b. RF Linear Power Amplifier TLAM-1KA

The TLAM-1KA is slide-mounted in the equipment cabinet and serves as the power amplifier for the HFLM-1KA. It contains two broadbanded, low level rf amplifiers and a final amplifier which provides 1000 watts PEP or average output. The final tube is an 8576 tetrode and is air-cooled by a blower within the TLAM-1KA. A front panel plate meter and its associated switch provides constant monitoring of the amplifier plate circuits. Also mounted on the front panel are an OUTPUT meter and associated switch for monitoring forward and reflected power, TUNE and LOAD controls, the BAND switch and associated band indicator lamps, and an ALDC control.

d. Low Voltage and Bias Supply Drawer AP-151

The AP-151 is slide-mounted directly above the AP-152. It contains the filament and bias transformer, low voltage transformer, and the overload, bias, and PTT relays. Mounted on the front panel and the SCREEN and PLATE circuit breakers, an INTERLOCKS indicator, the high voltage ALARM and its associated switch, a HIGH VOLTAGE indicator (used also as a combination push-button-indicator switch in certain configurations), and indicator fuses for BLOWER, FILAMENT, LV, BIAS, DC, and CONTROL.

e. High Voltage Power Supply AP-152

The heavy high voltage power supply components are mounted on a chassis and slide-mounted in the base of the equipment cabinet. The AP-152 contains the high voltage transformer, high voltage ON relay, and front and rear blower motors and associated high voltage circuitry. Mounted on the front panel are the MAIN POWER circuit breaker and indicator lamp.

1-3. REFERENCE DATA

Table 1-2 lists the technical specifications of the Linear Power Amplifier, HFLM-1KA.

TABLE 1-2. TECHNICAL SPECIFICATIONS

FREQUENCY RANGE:	2.0 MHz to 30 MHz. (dependent upon exciter capabilities)
OPERATING MODES:	Capable of all standard modes of operation (CW, AM, AME, ISB, SSB, FAX, FSK), but dependent upon the capabilities of the exciter being used with the HFLM-1KA.
POWER OUTPUT:	1000 watts peak envelope power or average
OUTPUT IMPEDANCE:	50 ohms, unbalanced (70 ohms optional).
STABILITY AND FREQUENCY CONTROL:	Capable of within 1 part in $10^8$ but dependent upon the stability of the exciter being used with the HFLM-1KA.
TUNING:	Manual
RF INPUT:	Provides 1000 watts PEP or average output with an input of approximately 100 milliwatts.
SPURIOUS SIGNALS:	At least 50 db down from rated PEP output.
HARMONIC SUPPRESSION:	Better than -45 db with reference to full PEP output.

TABLE 1-2. TECHNICAL SPECIFICATIONS (cont)

<p>HARMONIC FILTERS:</p> <p>NOISE:</p> <p>POWER SUPPLY RIPPLE:</p> <p>COOLING</p> <p>ENVIRONMENTAL:</p> <p>PRIMARY POWER:</p> <p>POWER REQUIREMENTS:</p> <p>SIZE:</p> <p>INSTALLED WEIGHT:</p> <p>COMPONENTS AND CONSTRUCTION:</p> <p>SPECIAL FEATURES:</p>	<p>Available as an option, fixed for all frequencies above 30 MHz or band-switched for lower frequencies.</p> <p>50 db down; special "white noise" protection.</p> <p>55 db down from full PEP output.</p> <p>Filtered forced air cooling; semi-pressurized cabinet.</p> <p>Designed to operate in any ambient temperature between the limits of 0 to 50°C for humidity up to 90%.</p> <p>115/230 vac, single phase, 50/60 Hz.</p> <p>Approximately 3.75 kilowatts.</p> <p>The individual components of the HFLM-1KA require an approximate rack space of 23"W x 27"D x 49"H. The overall size of the HFLM-1KA depends upon the customer selected options and equipment cabinet.</p> <p>The approximate total weight of the individual components of the HFLM-1KA is 500 pounds. The overall weight depends upon the customer selected options and equipment cabinet.</p> <p>Manufactured in accordance with JAN/MIL specifications wherever practicable.</p> <p>Overload protection and alarm circuitry, controlled and adjustable ALDC, and safety interlocks at all high voltage points.</p>
---	---

## SECTION 2

### INSTALLATION

#### 2-1. INITIAL UNPACKING AND INSPECTION

The HFLM-1KA Linear Power Amplifier was assembled, calibrated, and tested at the factory prior to shipment. Inspect all packages for possible damage during transit. Carefully unpack each crate as indicated by packing list provided with the linear amplifier shipment. Inspect all packing materials for parts which may have been shipped as loose items (cabinet hardware, connectors, technical manuals, etc.). With respect to damage to the equipment for which the carrier is liable, The Technical Materiel Corporation will assist in describing methods of repair and furnishing of replacement parts.

#### 2-2. POWER REQUIREMENTS

The HFLM-1KA requires a single phase source of 115 or 230 vac 50/60 Hz, at approximately 3.75 kw.

#### 2-3. INSTALLATION PROCEDURES

A minimum number of assemblies, subassemblies, components and hardware have been disassembled from the equipment and separately packaged, thus reducing the possibility of equipment damage during transit. The method of disassembly and separate packaging also permits realistic equipment handling.

Carefully read the instructions for each step of the installation procedure. After reading, consider the complexity involved in performing each step; it may be advisable to simulate a complex step before actually doing it. Make sure that each step has been completed before proceeding to the next.

Cables, wires, and other miscellaneous items that are disconnected during equipment disassembly for shipment are tagged and taped to the equipment. The information on a given tag indicates the designated terminal on a component to which the tagged item must be connected. Make sure all cables and wires have been connected as designated on tags and that all packing material, tags and tape have been removed before sealing-up the cabinet or section of the cabinet with a front panel drawer.

Temporary removal and replacement of panels and component mounting assemblies are specifically called out in the procedure in order to install the various items. Do not anticipate instructions; to insure correct installation, perform each step exactly as written.

### NOTE

Refer to the supplied equipment packing list to locate the appropriate crates containing the components, hardware and units outlined in the following steps.

#### STEP 1

- a. Unpack assorted LOOSE ITEMS from crate.
- b. Check each item contained against equipment supplied list.

#### STEP 2

- a. Unpack cabinet from crate, if supplied.
- b. Position cabinet upright (power supply grill located on lower portion of cabinet front indicates upright position), and remove rear panel as necessary (dependent upon equipment cabinet selection). The removal of rear panels on TMC furnished equipment cabinets can be accomplished by turning the screw fastener located at the left and right of the rear panel.
- c. Remove all packing material from cabinet and position cabinet in accordance with pre-installation planning.

### WARNING

INSURE THAT PRIMARY POWER EXTERNAL TO THIS EQUIPMENT IS OFF AND TAGGED.

#### STEP 3 (Primary AC Input Connection)

- a. Route ac input cable to base assembly and connect plug to PWR INPUT jack J2001. (on some models ac input connects to interface panel).

#### STEP 4 (Installation of Power Amplifier Tube, 8576)

- a. Remove the top cover from the TLAM-1KA.
- b. Carefully lift power amplifier tube from crate and position it on top of the PA tube socket in the TLAM-1KA.
- c. Position tube to line up with PA tube socket contacts.
- d. Carefully lower tube straight down into socket until slight resistance is encountered. Make sure that tube is centered in socket.
- e. Press tube firmly down into socket. A slight amount of effort may be required to seat tube. Caution should be observed in seating the tube so as not to damage contacts in socket. Check tube seating; it must be all the way down and centered in tube socket.
- f. Tighten retaining strap so that tube is held securely in place.

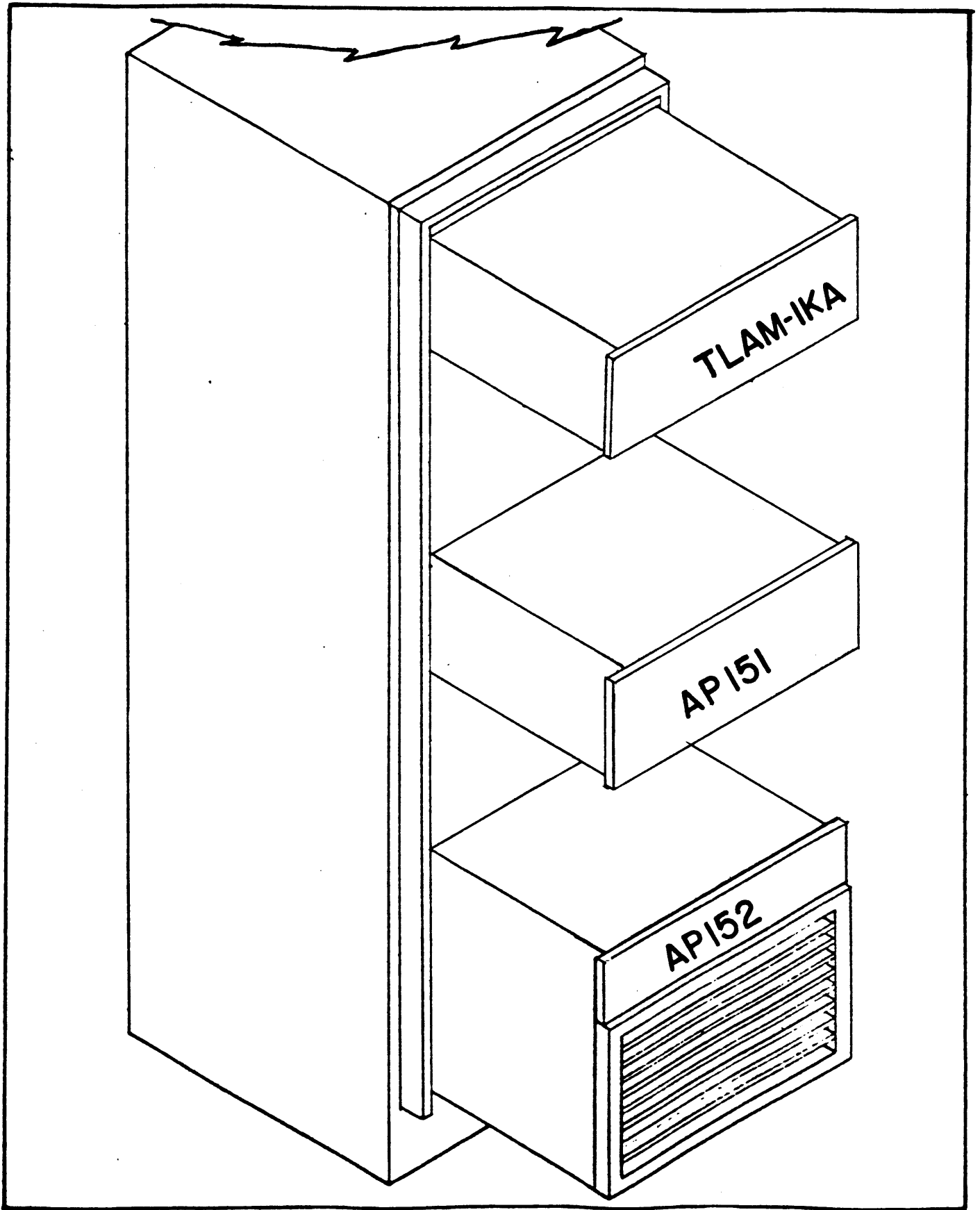

Figure 2-1. Typical HFLM-1KA Installation

- g. Replace the top cover of the TLAM-1KA and secure it in place.

#### STEP 5

- a. Remove all plug-in relays from LOOSE ITEMS crate.
- b. Install relays in their respective units; plug-in relays are marked for identification and ease in locating their respective sockets.

#### STEP 6 (Installation of Modular Units)

- a. All units in the HFLM-1KA are slide-mounted; refer to figure 2-1 for information regarding cabinet location of modular units.
- b. Begin the installation of modular units with the bottom unit (AP-152) and proceed up to prevent the equipment cabinet from tipping over.
- c. Untape or unstrap cable assemblies and all other components secured to the cabinet for shipment.
- d. Refer to figure 2-2 and pull the center section of the associated track out until it locks in an extended position.
- e. Position slide mechanisms of modular unit in tracks, and ease modular unit forward into rack until release buttons engage hole in track.
- f. Make the necessary cable and electrical connections to the modular unit. (Refer to part 1 of this manual for these interconnections and required external connections.)
- g. Depress release buttons and slide modular unit completely into compartment of equipment cabinet.
- h. Secure the front panel of modular unit to the cabinet with hardware provided.
- i. Repeat steps d through h for the installation of each modular unit in the equipment cabinet.

#### STEP 7

- a. Using the grounding hardware supplied, secure grounding strap to the equipment cabinet.
- b. Connect 50 ohm unbalanced antenna, or dummy load, to the output connector of the HFLM-1KA.
- c. Affix rear panel to cabinet and secure in place.

#### STEP 8 (High Voltage Transformer Check)

Once the HFLM-1KA has been installed and all modular units connected, it is recommended that the ac input to the high voltage transformer be checked. To do this, carefully read the instructions and proceed with extreme caution.

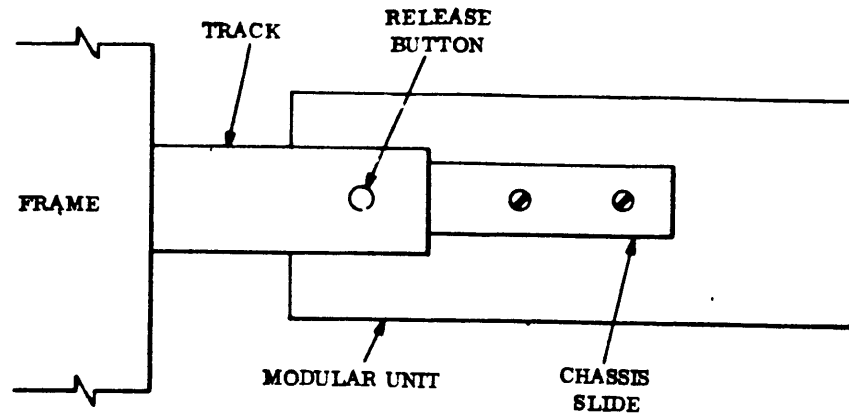

A NON-TILTING SLIDE MECHANISM

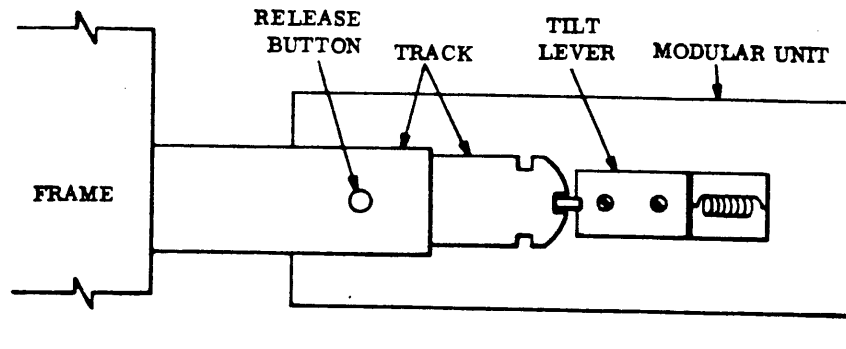

TILTING SLIDE MECHANISM

Figure 2-2. Slide-Mounting Details

CAUTION

With EXTERNAL PRIMARY POWER BREAKER AND MAIN POWER BREAKER SET AT OFF, the single phase ac input should MEASURE NOT LESS THAN 1 MEGOHM TO GROUND. The positive side of the high voltage circuit should measure not less than 100 kilohms.

WARNING

WHEN MEASURING AC VOLTAGE, USE EXTREME CAUTION. DO NOT TOUCH METER OR LEADS WHEN VOLTAGE IS ON. AFTER MEASURING VOLTAGE, PLACE MAIN BREAKER OFF BEFORE REMOVING LEADS.



- a. Insure primary AC BREAKER external to equipment is OFF and TAGGED.
- b. Make sure that the bias potentiometers located in the AP-151 Low Voltage and Bias Supply Drawer are turned to maximum bias (PA BIAS, 2ND AMP BIAS, and 1ST AMP BIAS potentiometers extremely clockwise).
- c. Place an ac voltmeter across the single phase input of the high voltage transformer located in the AP-152, High Voltage Power Supply (T101 terminals 1 and 3). The meter should be on the 300 vac range.
- d. Clear personnel away from the HFLM-1KA and apply primary power.
- e. On the AP-152 set the MAIN POWER breaker to the ON position.
- f. On the AP-151 set the PLATE and SCREEN breakers to the ON position.
- g. Wait approximately 10 to 15 minutes for all tube filaments to warm up.
- h. On the AP-151 unit press the HIGH VOLTAGE pushbutton switch; the HIGH VOLTAGE indicator should light. (H.V. pushbutton may have to be pressed twice)
- i. Note the ac input voltage as measured on the ac voltmeter.
- j. Press the HIGH VOLTAGE switch again to remove high voltage; the HIGH VOLTAGE indicator must go out.
- k. Place MAIN POWER breaker to OFF position.
- l. If the ac voltage noted in step i does not correspond with the ac input terminal markings on the high voltage transformer, relocate the ac input leads to the corresponding terminals on the high voltage transformer (refer to figure 7-2). Insure primary AC BREAKER external to equipment is OFF and TAGGED prior to performing the relocation of ac input leads.
- m. Repeat step h. Referring to figure 7-1 for corresponding voltage taps on low voltage and filament transformer T301 and T302. (located in AP-151 unit)
- n. Press H.V. pushbutton to remove high voltage.

#### 2-4. PRE-OPERATIONAL CHECKOUT PROCEDURE

Once the installation procedures are completed, pre-operational checks outlined in this paragraph should be performed to insure correct installation.

TABLE 2-1. PRE-OPERATIONAL CHECKOUT PROCEDURE

<u>Step</u>	<u>Modular Unit</u>	<u>Operation</u>	<u>Normal Indication</u>
1	AP-152	Set MAIN POWER breaker to ON position.	MAIN POWER indicator should light. Band indicator on TLAM should light.
2	AP-151	Set SCREEN & PLATE breakers to the ON position.	Approximately 60 seconds the interlocks lamp must light. If not, check that all interlock switches are closed.
3		Loosen panel locks on AP-151 and slide unit on chassis slides to expose BIAS ADJUST controls.	
<p style="text-align: center;"><u>NOTE</u></p> <p>The following steps give instructions for setting quiescent current values. Insure that the transmitter PTT line is closed (via associated exciter or jumper on interface panel) before attempting to set amplifier quiescent currents.</p> <p style="text-align: center;"><u>CAUTION</u></p> <p>Before applying high voltage to the transmitter, insure that the RF OUTPUT control on the MMX-2B is fully counterclockwise.</p>			
4	AP-151	Press the HIGH VOLTAGE switch to light indicator (it may be necessary to press the HIGH VOLTAGE switch twice).	HIGH VOLTAGE switch indicator will illuminate red.
<p style="text-align: center;"><u>NOTE</u></p> <p>For steps 6,7 and 8 the BIAS controls are located in the AP-151 drawer. Each individual amplifier has a bias level within the specified ranges, but peculiar to itself, in order for the amplifier to operate with minimum distortion.</p>			

TABLE 2-1. PRE-OPERATIONAL CHECKOUT PROCEDURE (CONT)

<u>Step</u>	<u>Modular Unit</u>	<u>Operation</u>	<u>Normal Indication</u>
5	TLAM-1KA	Set the Ip meter switch to 1ST AMP, and adjust the 1ST AMP BIAS control (located in AP-151) for between 40 to 50 ma on the Ip meter.	Ip meter will indicate quiescent current of 40 to 50 ma.
6	TLAM-1KA	Set the Ip meter switch to 2ND AMP, and adjust the 2ND AMP BIAS control (located in AP-151) for between 200 to 210 ma on the Ip meter.	Ip meter will indicate quiescent current of 200 to 210 ma on the Ip meter.
7	TLAM-1KA	Set the Ip meter switch to PA, and adjust the PA BIAS control (located in AP-151 for between 200 to 210 ma on the Ip meter.	Ip meter will indicate quiescent current of 200 to 210 ma.
8	AP-151	Slide AP-151 back into equipment cabinet and lock in place.	
9	TLAM-1KA	Rotage BAND control (clock-wise only) observe that BAND indicators light for each band position.	

SECTION 3  
OPERATOR'S SECTION

NOTE

For transmitter operating procedures refer to OPERATOR'S SECTION within the transmitter system portion of this manual.

See PART I (HFT-1KJ2B). SECTION 3

SECTION 4  
PRINCIPLES OF OPERATION

4-1. GENERAL

The HFLM-1KA transmitter provides manual tuning over a frequency range of 2 to 30 MHz. The transmitter requires an rf input of at least 100 mw.

The TLAM-1KA (power amplifier) contains two broadband low level rf amplifiers and a final amplifier that provides 1000 watts PEP or average output. The PA output is maintained constant at the selected power level by ALDC feedback to the exciter.

The RF Amplifier section contains three linear amplifier stages; the 1ST AMP, 2ND AMP and the POWER AMPLIFIER. The first and second amplifiers are broadband linears and require no tuning throughout the frequency range. The final stage is a tuned parallel L circuit that provides an output impedance of 50 ohms.

All RF Amplifier stages are air-cooled by a self-contained blower located inside the Power Amplifier section. Front panel meters monitor plate currents, output power in kilowatts and indications of current and/or SWR overloads.

4-2. BLOCK DIAGRAM ANALYSIS. (Refer to figure 4-1.)

Figure 4-1 illustrates the rf signal flow of the HFTM-1KA transmitter. When all circuit conditions are met and a suitable exciter used to drive the HFLM, rf voltage is amplified and routed to the output connector in the following manner.

The external exciter's output (2.0 to 30 MHz) is routed to the TLAM-1KA. This exciter output level must be at least 100 milliwatts.

From this point the exciter output, controlled by the exciter RF OUTPUT control knob, is routed to the 1ST RF AMPLIFIER, V1201. V1201 serves to amplify the exciter output to a level sufficient to drive the 2nd RF AMPLIFIER, V1201. V1202 further amplifies the rf output which is routed to the input of the 1 kilowatt POWER AMPLIFIER, V1201.

The 1ST and 2ND AMPLIFIERS are broadbanded throughout the frequency range to simplify tuning and operation. However, the Power Amplifier employs the use of TUNE and LOAD controls for PA tuning and output loading. Note that the 1 kilowatt output passes through a directional coupler that samples and rectifies a portion of the rf output for metering purposes.

The directional coupler and KILOWATT meter combination monitor the HFLM's output and is calibrated in average power.

Output overload (SWR) is provided in addition to plate circuit overload to protect the HFLM against antenna voltage standing wave ratios.

Operationally during voice modulation, the possibility of high modulation peaks that may cause the HFLM to dump through it's overload circuitry is always apparent. Therefore, the Automatic Load and Drive Circuit reduces this condition when used with a suitable exciter that will accept this negative voltage to maintain a constant input level, which in effect will provide a constant HFLM output.

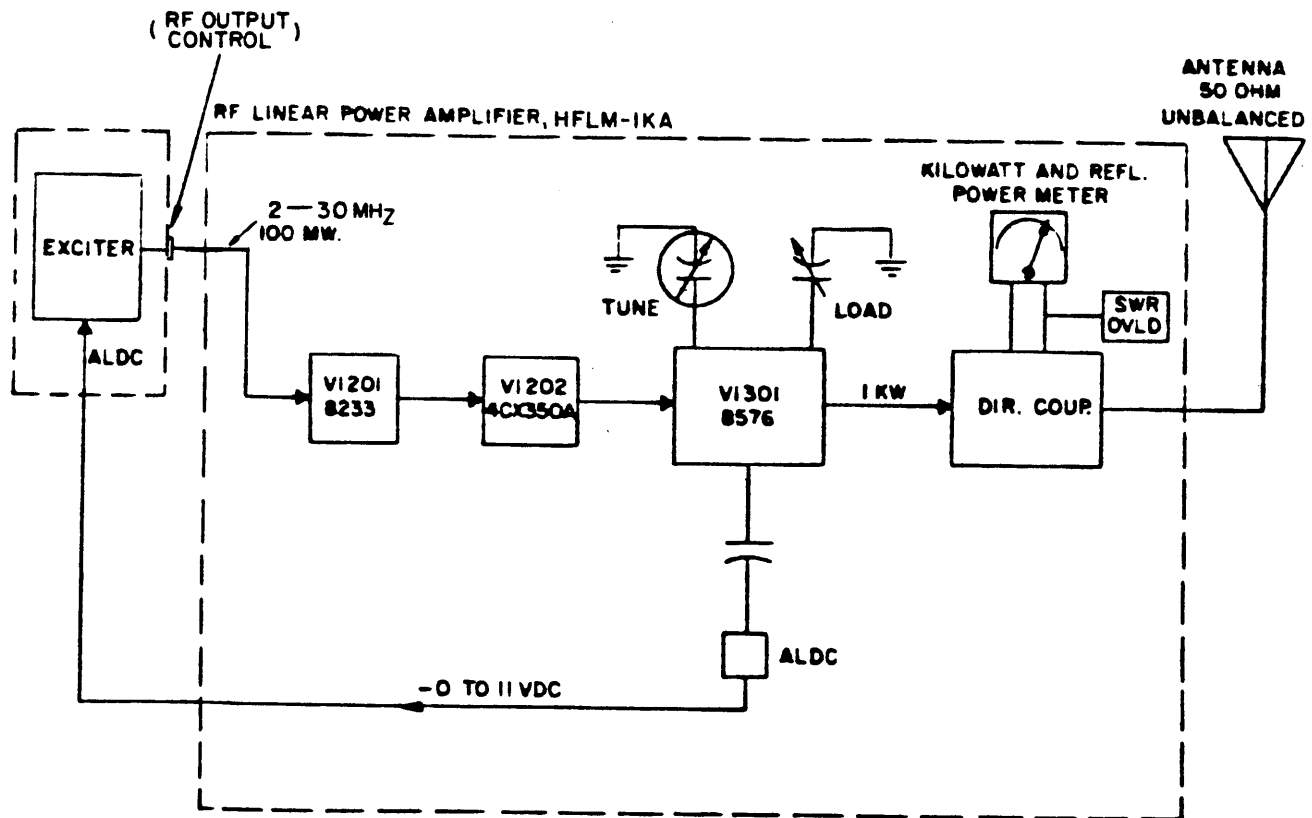

Block Diagram, HFLM-1KA

Figure 4-1

### 4-3. AC POWER DISTRIBUTION (refer to figure 4-2)

#### a. General

Single phase primary power is applied to PWR INPUT jack or terminals and provide primary voltages for transmitter operation. The HFLA-1KA system is interlocked throughout for personnel and equipment safety. When one of the protective interlocks open, power is removed from the transmitter and high voltage is automatically shut off.

#### b. Block Diagram Analysis

Primary single phase 115 or 230 vac is connected to PWR INPUT and is routed to one side of MAIN POWER breaker CB101. Closure of the MAIN POWER breaker provides ac power to the MAIN POWER indicator (DS101), high voltage on/off relay contacts (K101), one section of high voltage transformer (T101), front and rear fans B101 and B102 respectively. AC power is also routed through J101 pin I and enters the TLAM-1KA at J1003 pin U, to one side of PA fan B1301. Primary ac is applied to the other side of the PA fan via fan fuse F301 causing the fan to operate thus closing the contacts of blower air switch S1301. The closed air switch contacts provides an ac path through J1003 pin V and is routed to Low Voltage and Bias supply at J301 pin h and re-routed to one side of filament/bias transformer T301 and one side high voltage transformer T302.

Single phase ac is also routed through AP-152 J101 pin H to J301 pin E and through Low Voltage fuse F303 to the other side of Low Voltage transformer T302.

#### c. Low Voltage/Bias Power Supply AP151

With primary ac applied to the primary of low voltage transformer T302, 36 vac is applied to CR303 which is the source of the 24V DC supply. Primary ac at the junction of J301 pin E is also routed to Filament/Bias transformer T301 via filament fuse F302. The secondary of transformer T301 provides 230 vac to K301 bias relay contacts, 6.8 vac for the PA filament voltage, and bias voltage for the amplifier tubes.

#### d. Linear Power Amplifier TLAM-1KA

It can be seen thus far that should PA fan B1301 fail to operate ac power would be removed from both the filament bias transformer, T301 and low voltage transformer T302. When voltage is removed from T301 and T302, primary bias voltage, filament voltage and the 24 vdc would be disabled.

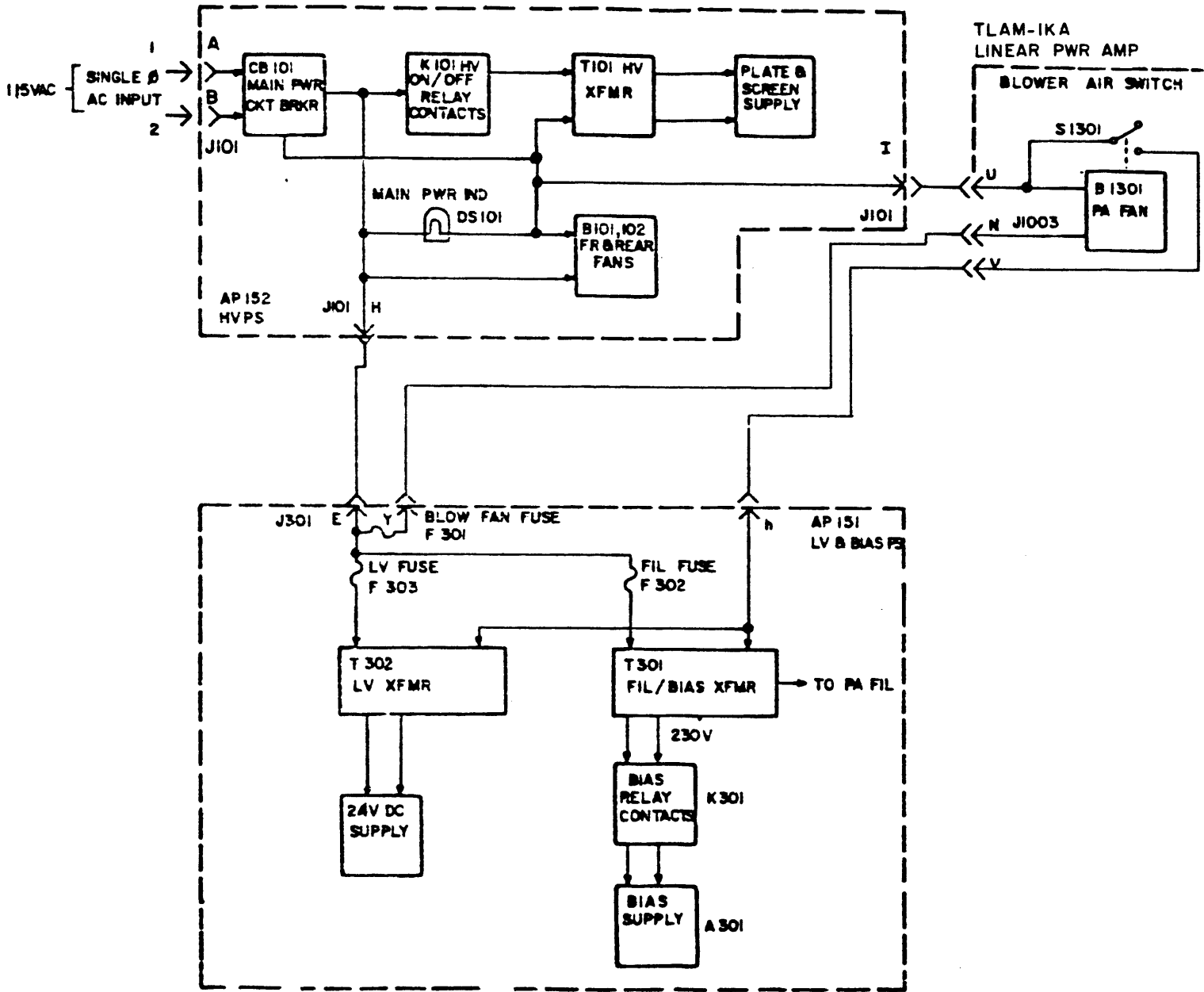

Figure 4-2. AC Power Distribution



#### 4-4. DC POWER DISTRIBUTION (Refer to figure 4-3)

##### a. Plate and Screen Voltages

Application of ac power to High Voltage transformer T101 provides plate and screen voltage for RF Amplifier tubes V1301, V1201, and V1202. 4000 vdc is derived from plate rectifier A101 for plate voltage to the PA tube V1301.

Screen rectifier A102, also rectifies the secondary output of T101. This rectified output is fed to Zener diode assembly A103 that functions to regulate dc voltage potentials. Within the zener assembly, voltages are tapped and applied to RF Amplifier tubes as follows:

- (1) 200 vdc First Amplifier Screen (V1201)
- (2) 400 vdc Second Amplifier Screen (V1202)
- (3) 800 vdc Power Amplifier Screen (V1301)

The screen rectifier also furnishes 2000 vdc for the plate of V1202 and 400 vdc for the plate of V1201.

Filament transformer T301 supplies 6.3 vac filament voltage to each RF Amplifier tube.

##### b. BIAS Voltage (Refer to figure 4-4)

When Bias Relay K301 energizes, ac voltage is applied to the bias rectifier A301. The negative dc output of A301 (approximately 240 vdc) is filtered by L301, L302, C301 and C302 before application to the zener diode regulators. The dc return for the Bias supply is through Bias fuse F304 to protect the circuit against overloads. Regulated bias voltages are tapped from Zeners CR301 and CR302 for application to the three bias potentiometers. The ground necessary for the voltage drop across the PA bias potentiometer is supplied by contacts of the energized PTT relay K1. The bandswitch and/or harmonic filter interlock circuit prevents 24 vdc from reaching the PTT relay during band changes to keep the PA amplifier stage at maximum bias, or close to cut off.

The bias supply provides -200 vdc to the PA bias potentiometer. The bias potentiometer is adjusted to provide between 200 ma and 210 ma quiescent current on the PA (Ip) plate current meter when the meter switch is in it's normal position. The junction of CR301 and CR302 provides -50 vdc to the 2ND AMP and 1ST AMP bias potentiometers before application to the 2ND and 1ST AMP grids. The 2ND AMP bias potentiometer is adjusted to provide between 200 ma and 210 ma on the Ip meter when the meter switch is in the 2ND AMP (up) position. The 1ST AMP bias potentiometer is adjusted to provide between 40 ma and 55 ma when the meter switch is in 1ST AMP (down) position.

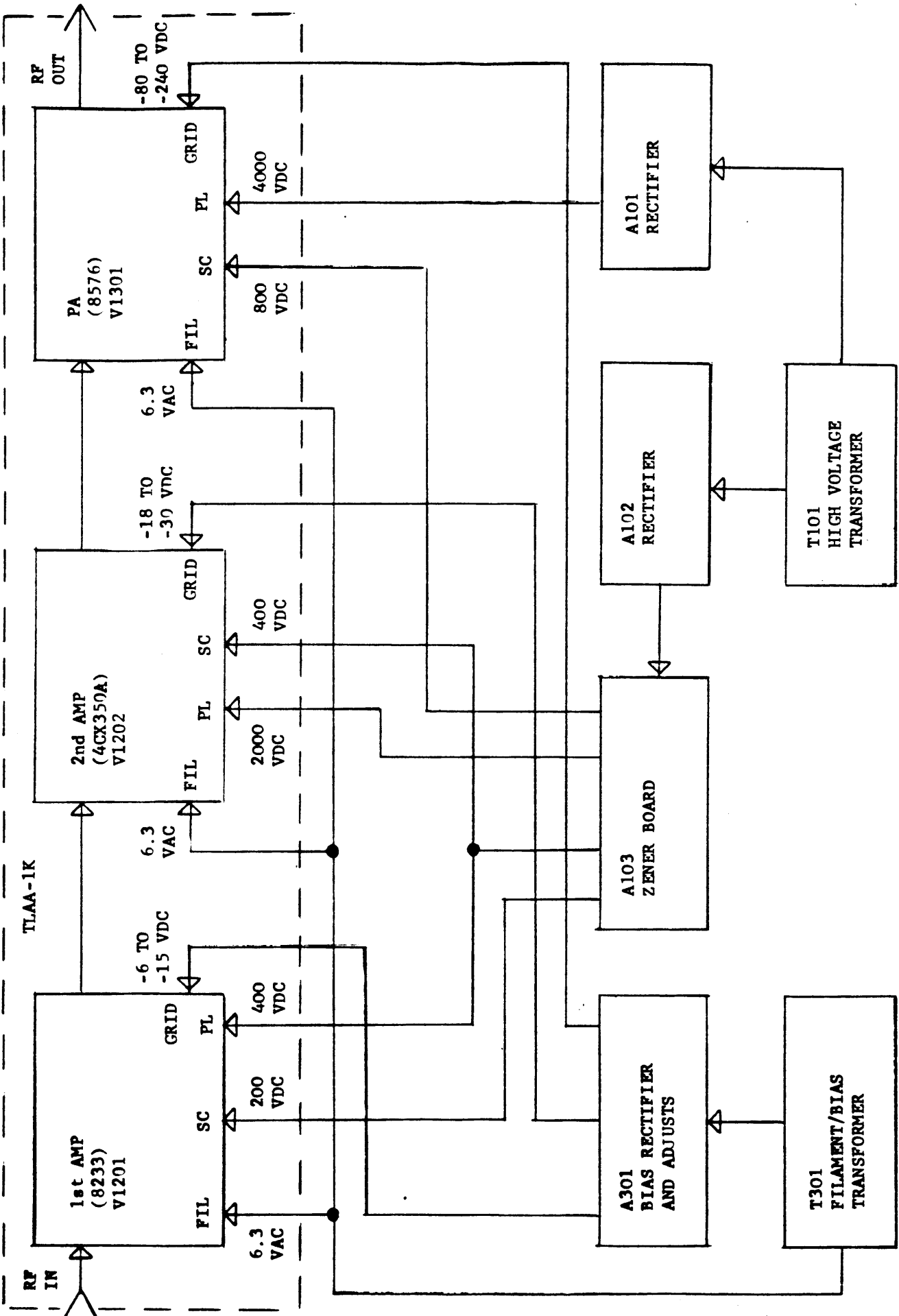

Figure 4-3. HFLM-1KA OPERATING POTENTIALS

FILA & BIAS TRANSFORMER

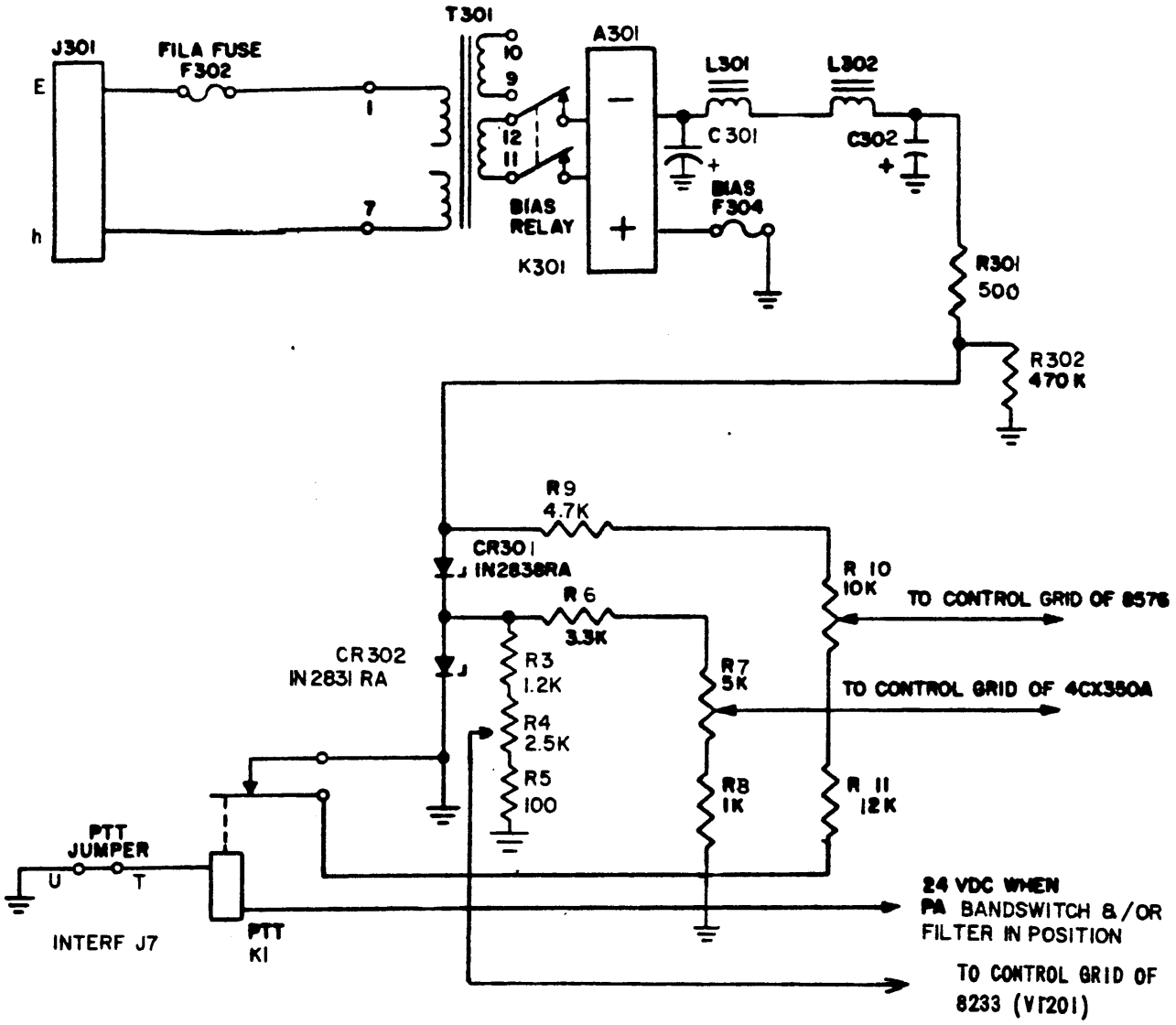

FIGURE 4-4. SIMPLIFIED BIAS CONTROL

#### 4-5. PROTECTIVE INTERLOCKS AND OVERLOADS

Simplified High Voltage Overloads and Interlocks Circuit Analysis  
(Refer to figure 4-5)

The 24 vdc derived in the AP-151, Low Voltage and Bias supply is routed to Time Delay Z1101. When the elapsed time is completed the 24 vdc is routed through mechanically closed protective interlocks (S1101, S1003, S2001, S2003 and External interlock). When all interlocks are closed 24 vdc is applied to K301 the bias on relay and Interlock indicator DS301, CB302 PLATE circuit breaker, CB301 SCREEN circuit breaker and one side of H.V. on/off relay K101.

When H.V. on/off switch is pressed to ON (switch indicator lights) 24 vdc is switched to overload board A1001, ON indicator DS302, consequently lighting the H.V. indicator. Simultaneously a ground path is provided via contacts on reset relay K2 and this ground is routed to H.V. ON/OFF relay K101, and H.V. ON indicator. Closed contacts on K101 energizes the plate and screen supply providing plate voltage and screen voltage to the RF amplifier tubes V1201, V1202, and V1301.

When an interlock switch is opened the 24 vdc is removed from H.V. ON/OFF relay K101 and Bias relay K301 and is re-routed via the normally closed position of the interlock switches to the overload relay A301K1. The energized overload relay removes the ground that is required to energize the H.V. ON/OFF relay and H.V. ON indicator light.

The contacts on the overload relay also provide a ground path to one side of ALARM ON/OFF switch S301 (when ALARM switch is in ON position with H.V. off due to an overload the audible alarm would sound).

An indication on the PLATE current meter ( $I_p$ ) that is equal to the setting of the red overload pointer provides a contact closure on the meter sensing circuit. The contact closure supplies a gating pulse to trigger an overload SCR, providing a path for the 24 vdc to the overload lamp on the meter, and 24 vdc to the OVLD relay, causing it to unlatch and de-energize the H.V. ON/OFF relay.

A dc sample from the reflected power diode is routed through an operational amplifier and the SWR ADJ. potentiometer. The dc sample provides a trigger for the associated SCR, providing a path for the 24 vdc to the SWR overload lamp on the RF Amplifier front panel.

To restore high voltage, the H.V. ON/OFF pushbutton switch is pressed twice. Pressed the first time, the H.V. ON/OFF switch provides 24 vdc to the reset side of the OVLD RELAY and closing the contacts on the relay. Pressed the second time, the H.V. ON/OFF switch restores the 24 vdc to the contacts necessary to energize the H.V. ON/OFF relay which applies plate and screen voltages to the transmitter again.

Should any of the interlocks open when H.V. is ON, the overload coil on the overload relay is diverted to a line connecting all the normally closed contacts of the interlocks to the overload side of the overload relay. An open interlock places the transmitter in an overload condition, preventing the potentially dangerous application of high voltage when the open interlock is closed.

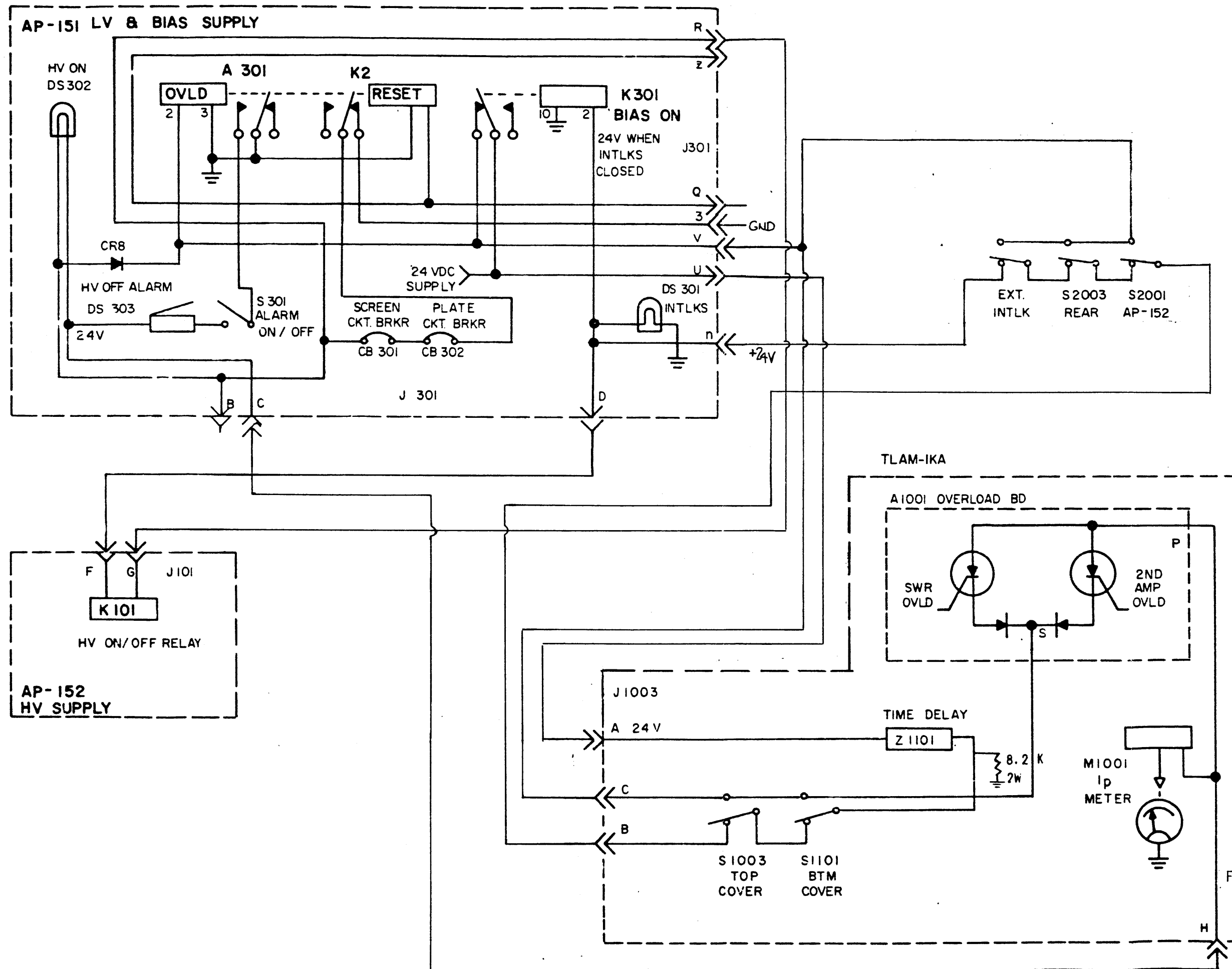

Figure 4-5. Simplified Interlock & HV Overload Circuits

#### 4-6. ALDC.

The ALDC circuit provides a feedback voltage to an associated exciter to prevent excessive rf output from the transmitter.

A filtered and regulated 24 vdc is routed through the ALDC potentiometer (R1109) and applied to the ALDC Assembly located in the TLAM-1KA. This voltage is used to back bias the ALDC rectifier. The threshold adjusted ALDC voltage leaves the ALDC Assembly and is routed to the ALDC input of an exciter. The ALDC threshold adjustment is normally adjusted on carrier so that increase in rf will not exceed the Power Level reading.

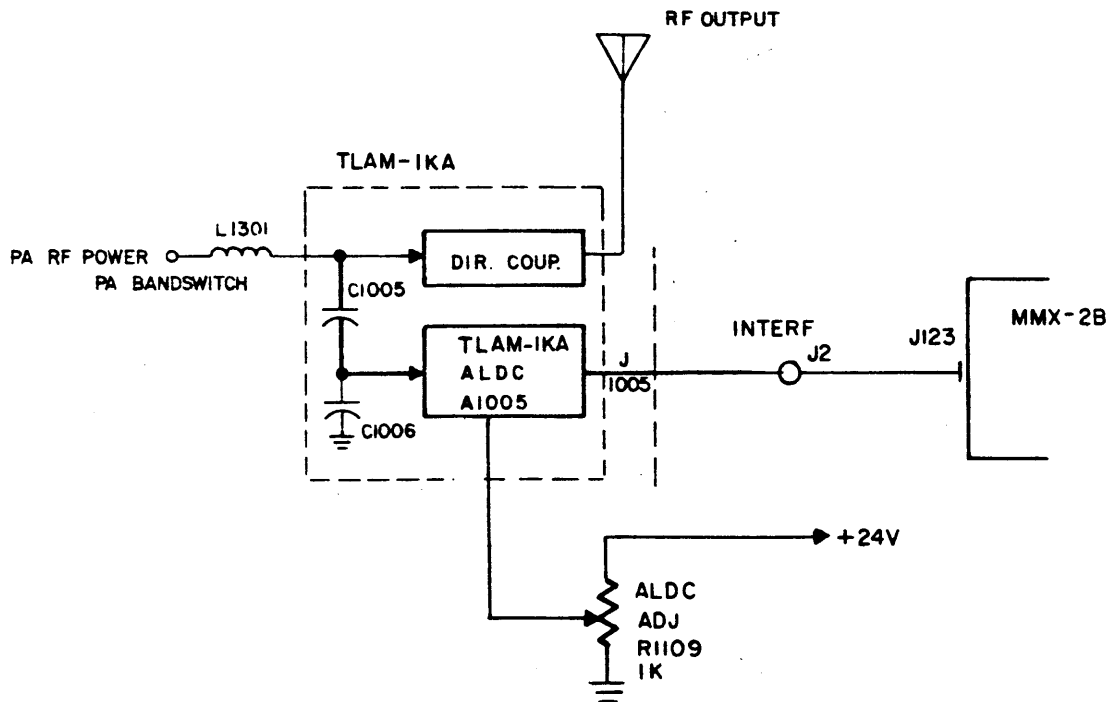

Figure 4-6

Simplified ALDC Circuit

SECTION 5  
MAINTENANCE

5-1. INTRODUCTION

The HFLM-1KA has been designed for long term trouble free operation. When it becomes necessary to perform alignment and/or adjustments to the equipment, it is recommended that technicians perform the necessary operations outlined in the applicable paragraphs in this section.

A. The following maintenance aids are provided for troubleshooting, alignment and replacement of parts.

1. System block diagram (Section 4 Figure 4-1)
2. Fuse Location Drawing (Figure 5-1)
3. Fuse Functions (Table 5-2)
4. System overload and bias setting procedure
5. Auto-Tuning adjustment procedure

5-2. LIST OF TEST EQUIPMENT REQUIRED

Signal Generator	Hewlett Packard Model 606A or equivalent
VTVM	Hewlett Packard Model 410B or equivalent
Multimeter	Simpson Model 260 or equivalent

5-3. OPERATOR'S MAINTENANCE PROCEDURE

- a. Refer to operational checkout procedures (Part I, Section 3).
- b. Refer to operator's troubleshooting chart (Table 5-1).

5-4. PREVENTIVE MAINTENANCE

In order to prevent equipment failure due to dust, dirt or other destructive elements, it is suggested that a schedule of preventive maintenance be set up and adhered to.

At periodic intervals, the equipment should be pulled out on its slides for internal cleaning and inspection. The wiring and all components should be inspected for dirt, dust, corrosion, grease or other harmful conditions. Remove dust with a soft brush or vacuum cleaner. Remove dirt or grease with any suitable cleaning solvent. Use of carbon tetrachloride should be avoided due to its highly toxic effects. Trichlorethylene or methyl cloroform may be used, providing the necessary precautions are observed.

### WARNING

WHEN USING TOXIC SOLVENTS, MAKE CERTAIN THAT ADEQUATE VENTILATION EXISTS. AVOID PROLONGED OR REPEATED BREATHING OF THE VAPOR. AVOID PROLONGED OR REPEATED CONTACT WITH SKIN. FLAMMABLE SOLVENTS SHALL NOT BE USED ON ENERGIZED EQUIPMENT OR NEAR ANY EQUIPMENT FROM WHICH A SPARK MAY BE RECEIVED. SMOKING, "HOT WORK", ETC. IS PROHIBITED IN THE IMMEDIATE AREA.

### CAUTION

WHEN USING TRICHLORETHYLENE, AVOID CONTACT WITH PAINTED SURFACES, DUE TO ITS PAINT REMOVING EFFECTS.

## 5-5. TROUBLESHOOTING

The first step in troubleshooting is as follows:

### a. Observations

Observe the operation of transmitter and determine whether the indications are normal or abnormal. (Refer to operator's section Part I, Section 3).

### b. Fuse Checks

Should a malfunction occur a visual check of fuses on the system must be performed. (All fuses are indicating type. Refer to Figure 3-2 of Part I, Section 3 for fuse location.)

### c. Voltage Checks

At this time voltage checks are not necessary until localization of the malfunction has taken place.

### d. Localization of Malfunction

Perform the operation procedure outlined in Part I, Section 3. Use of this procedure will help localize the particular fault at hand.

### e. Field Maintenance

Procedures presented on the following pages give instructions for qualified personnel to maintain, align, and/or troubleshoot the HFLM-1KA Transmitter.



WARNING

WHEN IT BECOMES NECESSARY TO MEASURE TRANSMITTER VOLTAGES, USE EXTREME CAUTION, HAZARDOUS VOLTAGE POTENTIALS ARE PRESENT ALTHOUGH MAIN POWER BREAKER MAY BE OFF. IT IS RECOMMENDED THAT THE FOLLOWING PRECAUTION BE STRICTLY ADHERED TO!

1. CHECK TO ASCERTAIN MAIN PRIMARY POWER IS OFF OR REMOVED FROM TRANSMITTER.
2. SHORT OUT ALL H.V. POINTS WITH SHORTING STICK.
3. ATTACH TEST METER TO POINT OF TEST DESIRED, RE-APPLY VOLTAGE TO TRANSMITTER.
4. WHEN MEASURING HIGH VOLTAGE POTENTIALS DO NOT TOUCH TEST METER OR LEADS ONCE VOLTAGE HAS BEEN APPLIED.
5. ESTABLISH TEST CONDITIONS AND OBSERVE READING ON TEST METER.
6. REMOVE PRIMARY POWER, SHORT OUT ALL HIGH VOLTAGE POINTS; REMOVE TEST METER.

TABLE 5-1. OPERATOR'S TROUBLESHOOTING CHART

<u>No.</u>	<u>Malfunction</u>	<u>Probable Cause of Malfunction</u>
1	Blower will not operate.	Replace defective BLOWER fuse.
2	PA Plate current and 2ND AMP Plate current excessive.	Replace defective BIAS fuse, or check bias adjustments for proper levels.
3	Interlock Indicator will not light.	Replace defective DC fuse, or check for open interlock.
4	HIGH VOLTAGE indicator will not light when HIGH VOLTAGE switch is pressed.	Replace defective LOW VOLTAGE fuse. Check that PLATE and SCREEN breakers are in ON position. High Voltage switch may have to be pressed twice.

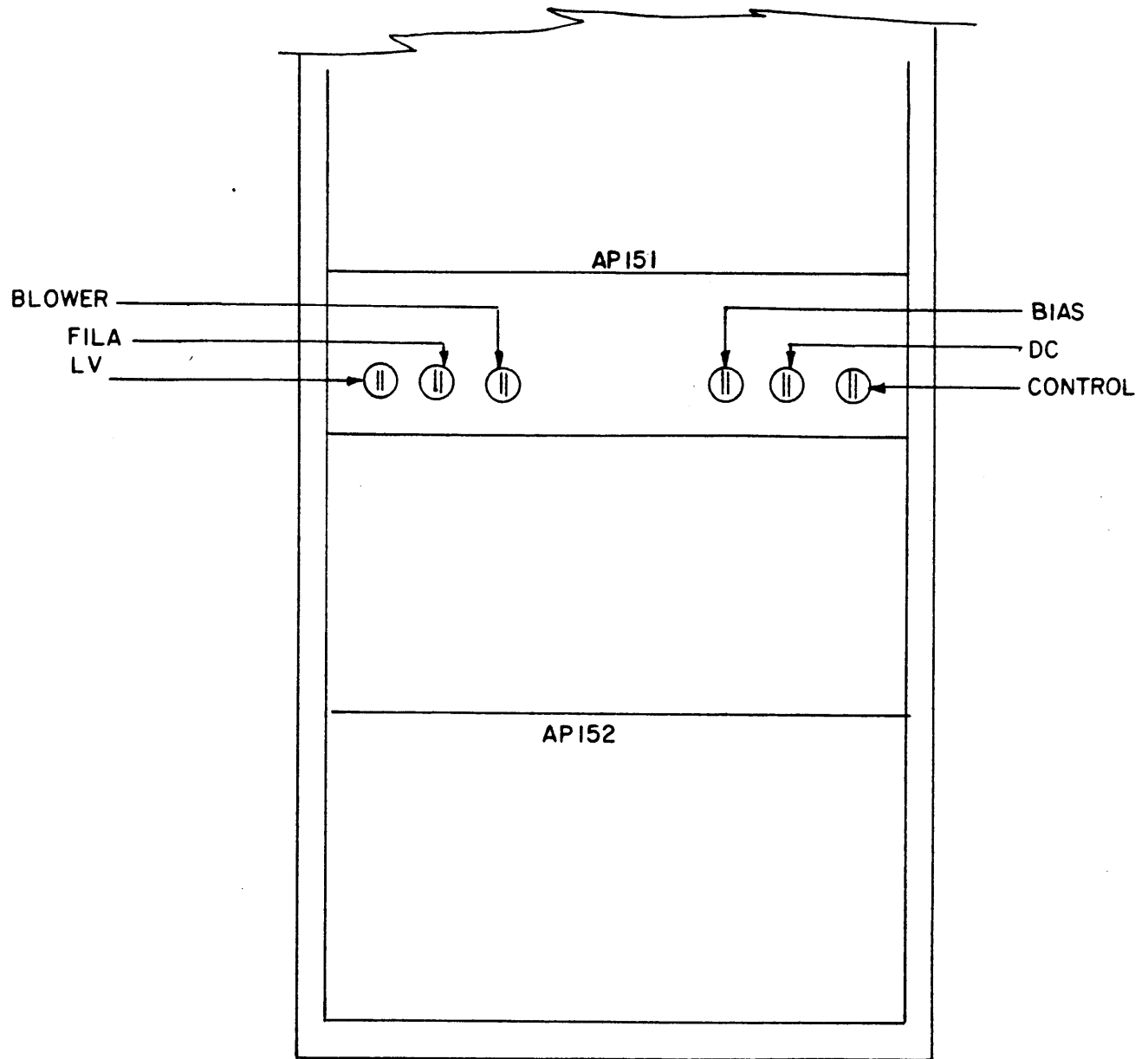

Figure 5-1  
Fuse Location Drawing

TABLE 5-2. FUSE FUNCTIONS

<u>No.</u>	<u>Fuse</u>	<u>Function</u>
1	BLOWER Fuse	Protective fuse for blower, lights to indicate fuse defective (1.5 amp 115 vac, .75 amp 230 vac).
2	FILAMENT Fuse	Protective fuse for Filament and Bias transformer, lights to indicate fuse defective (2.0 amp 115 vac, 1.0 amp 230 vac).
3	BIAS Fuse	Protective fuse for dc return of bias supply, lights to indicate fuse defective (.2 amp).
4	L.V. Fuse	Protective fuse for primary ac input to L.V. transformer, lights to indicate fuse defective (1.0 amp 115 vac, .5 amp 230 vac).
5	DC Fuse	Protective fuse for dc return of 24 vdc supply, lights to indicate fuse defective (2.0 amp).
6	CONTROL Fuse	Protective fuse for Low Voltage and Filament-Bias transformer, lights to indicate fuse defective (1.0 amp 115 vac).

5-6. ALDC ADJUSTMENT PROCEDURE (Refer to figure 4-6)

Purpose:

The ALDC adjustments outlined are for the purpose of limiting RF PEAK power during modulation emission modes. The transmitter provides a negative dc voltage which is adjustable and proportional to the transmitter output. This voltage is made available at the transmitter ALDC jack to interface with an appropriate exciter. The exciter accepts this voltage to limit the RF drive.

a. Rotage the front panel ALDC control (on TLAM-1KA) counterclockwise for minimum ALDC action. Tune and load the transmitter to a carrier frequency of 12 MHz (a 12 MHz input signal must be available from the associated exciter or a signal generator).

1. Adust RF Control on the MMX-2B for a PA output indication of 1100 watts.
2. Adjust ALDC threshold knob (located on the front panel of the TLAM-1KA until the power output indication commences to decrease.
3. Continue to adjust the ALDC threshold knob fbr a PA Output indication of 1000 watts.
4. Increase RF control on the MMX-2B (to check ALDC capture). PA Output should remain constant.

5. Reduce RF drive to minimum and turn off H.V. This completes ALDC adjustment procedure.

The ALDC adjustment may be set for values lower than specified in the procedure if desired.

NOTE

Should the ALDC capture voltage be insufficient, resulting in an increase in PA Output when rf drive is increased, further adjustment of the ALDC knob may be necessary to hold the PA Output constant.

5-7. TRANSMITTER BIAS ADJUSTMENT PROCEDURE (Refer to Figure 5-4, 4-4)

The bias adjustments outlined below are to obtain quiescent tube values. Before bias adjustments can be made the Low Voltage Power Supply (AP151) must be extended out on its slides to expose the bias adjustment potentiometers.

1. Adjust bias controls maximum clockwise (bias voltage will be at a maximum value.)
2. Place MAIN POWER, PLATE and SCREEN breakers to the ON position.
3. Insure that RF Control (MMX-2B) is at minimum (completely counter clockwise).

TABLE 5-3. TUBE QUIESCENT CURRENT VALUES

REF SYM	TUBE TYPE	TUBE FUNCTION	QUIESCENT PLATE CURRENT ADJ TO
V1201	8233	1ST AMP	40-50 ma
V1202	4CX350A	2ND AMP	200-210 ma
V1301	8576	PA	200-210 ma

NOTE

1. MAX BIAS VOLTAGE WILL BE PRESENT IF:
  - A. BANDSWITCH OR FILTER (OPTIONAL) NOT IN PROPER POSITION.
  - B. PTT RELAY NOT ENERGIZED.
  - C. BIAS CONTROLS ARE AT MAX CLOCKWISE.
2. WHEN MAX BIAS VOLTAGE IS PRESENT AT V1201, V1202, V1301 THE QUIESCENT PLATE CURRENT IS REDUCED TO ZERO WHICH PLACES THE AMPLIFIERS AT OR NEAR CUTOFF.
5. Press HIGH VOLTAGE button to light indicator subsequently applying HIGH VOLTAGE.

6. Observe "Ip" meter and adjust PA BIAS control for an indication between 200 ma - 210 ma as read on Ip meter.

7. Hold meter switch "UP" (to 2ND AMP position), observe Ip meter, and adjust 2ND AMP bias control for an indication between 200 ma - 210 ma as read on Ip meter.

8. Hold meter switch down (1ST AMP position) observe Ip meter and adjust 1ST AMP bias control for an indication between 40 ma - 50 ma as read on the Ip meter.

9. Press HIGH VOLTAGE switch to OFF position. (HIGH VOLTAGE indicator must go out.) Slide drawer back to original position.

#### 5-8. OVERLOAD CIRCUIT TEST

##### a. PURPOSE

The Overload Circuitry functions to protect the HFLM-1KA against possible excessive current and VSWR overloads. To set and/or check the overloads perform the following.

1. Energize Transmitter (MAIN POWER breaker ON, PLATE SCREEN breaker ON).
2. Loosen panel locks and extend low voltage drawer out on its slides to expose bias controls.
3. Press HIGH VOLTAGE switch to ON (HIGH VOLTAGE indicator should light).
4. Apply rf (12) MHz to HFLM-1KA
5. Tune transmitter for rated output.
6. Reduce rf drive to minimum.

##### NOTE

When overload occurs, HIGH VOLTAGE switch must be pressed twice to re-apply high voltage. Press to reset overload and press to apply high voltage.

#### 5-9. PA PLATE OVERLOAD ADJUSTMENT

Step 1 Adjust Overload indicator (adjustment screw (part of meter) located directly below meter face) for 300 ma as indicated on PLATE current meter.

Step 2 Adjust PA Bias control counterclockwise until PLATE current meter indicates 300 ma. Observe the following:

- a. When meter indicator reaches the value of overload indicator setting, the high voltage will trip off.
- b. PLATE current ( $I_p$ ) meter face will illuminate, indicating overload in plate current.
- c. Meter indicator will remain at the overload value to indicate which caused overloaded condition.

Step 3 Readjust bias to maximum clockwise position and press HIGH VOLTAGE pushbutton to reset high voltage. (H.V. Switch must be pressed twice.)

Step 4 To check further operation of plate overload, adjust bias control counterclockwise again, noting that high voltage tripped as in Step 2; set overload indicator for indication of 800 ma. Readjust PA bias control for 200 - 210 ma as indicated on the  $I_p$  meter.

#### 5-10. 2ND AMPLIFIER PLATE OVERLOAD ADJUSTMENT (Refer to Figure 5-6)

Step 1 Extend TLAM out on its slides to expose the 2ND AMP and SWR overload adjustment control.

Step 2 Push "PLATE meter switch" up and observe 2ND AMP plate current.

Step 3 Adjust 2ND BIAS control counterclockwise until 2ND AMP plate current indicates 400 ma.

Step 4 Adjust 2ND AMP PLATE OVERLOAD potentiometer until high voltage trips off (located on bottom of TLAM-1KA).

- a. PLATE current meter will illuminate, indicating overload in 2ND AMP plate current.
- b. High Voltage will trip OFF, HIGH VOLTAGE indicator will go out.
- c. PLATE current meter will indicate zero.

Step 5 Readjust 2ND AMP BIAS control to maximum clockwise position and press HIGH VOLTAGE pushbutton to reset high voltage (HIGH VOLTAGE switch must be pressed twice).

Step 6 To check further operation of 2ND AMP PLATE OVERLOAD, readjust bias control counterclockwise again, noting that high voltage tripped as in Step 4.

Step 7 Reset bias control for a 2ND AMP plate current reading of 200 to 210 ma.

5-11. SWR OVERLOAD ADJUSTMENT (Refer to Figure 5-6)

- Step 1 Tune transmitter into a 50 ohm dummy load at a frequency of 12 MHz.
- Step 2 Remove HIGH VOLTAGE. Disconnect antenna or dummy load.
- Step 3 Press HIGH VOLTAGE pushbutton to apply high voltage.
- Step 4 Push SWR pushbutton and carefully increase drive until a reading of 250 watts on KILOWATT meter, is observed on the reflected power scale.
- Step 5 Adjust SWR potentiometer until high voltage trips OFF (located on bottom of TLAM-1KA).
- a. The OUTPUT meter will illuminate
  - b. High voltage will trip OFF; HIGH VOLTAGE indicator will go out.
  - c. PLATE current meter will indicate zero.
  - c. To further check operation of SWR overload, reduce RF Drive, press HIGH VOLTAGE pushbutton to ON and increase RF Drive again until overload trips HIGH VOLTAGE OFF.

NOTE

For SWR settings other than 2:1, refer to Figure 5-2.

POWER VALUES vs. VSWR

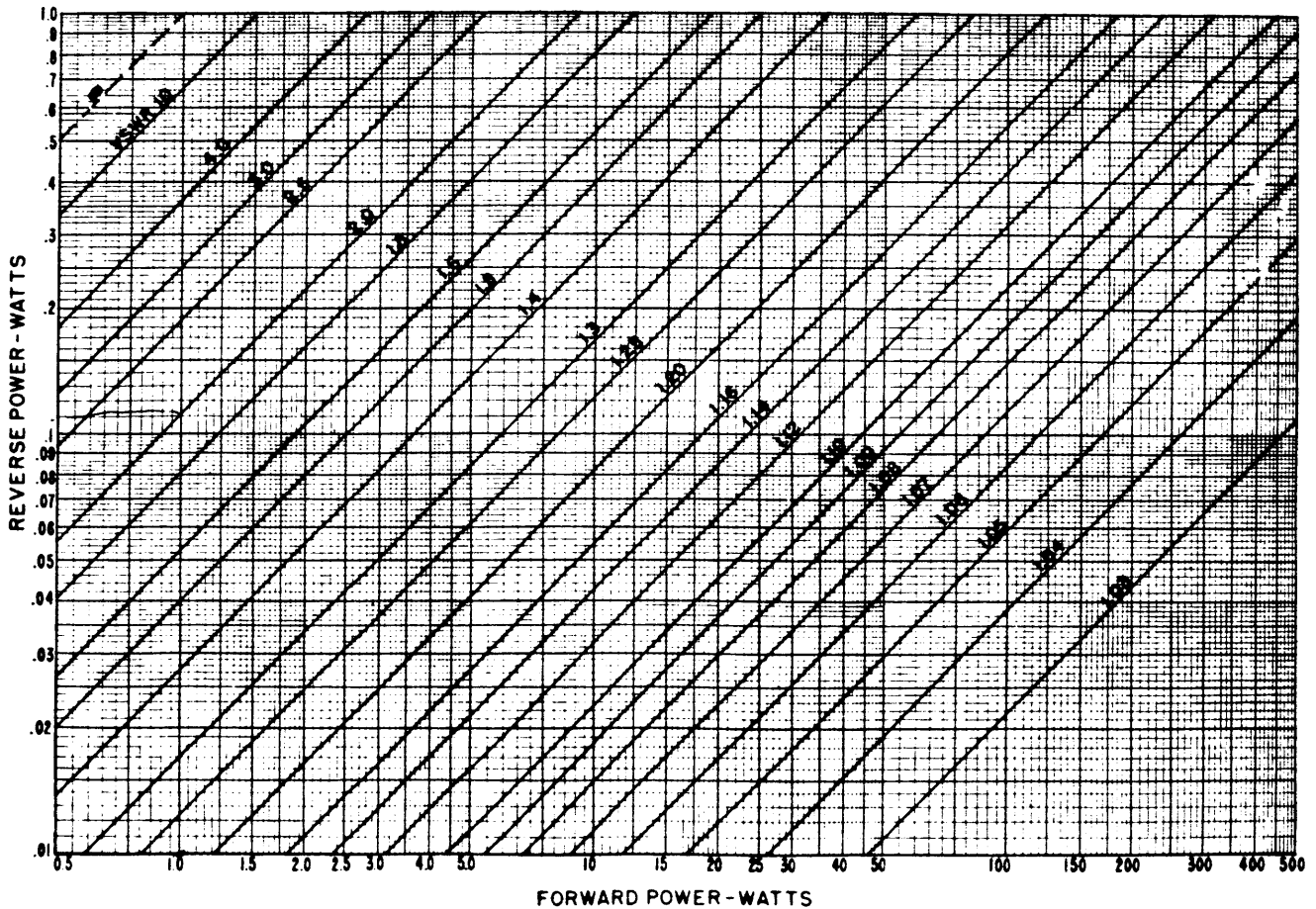
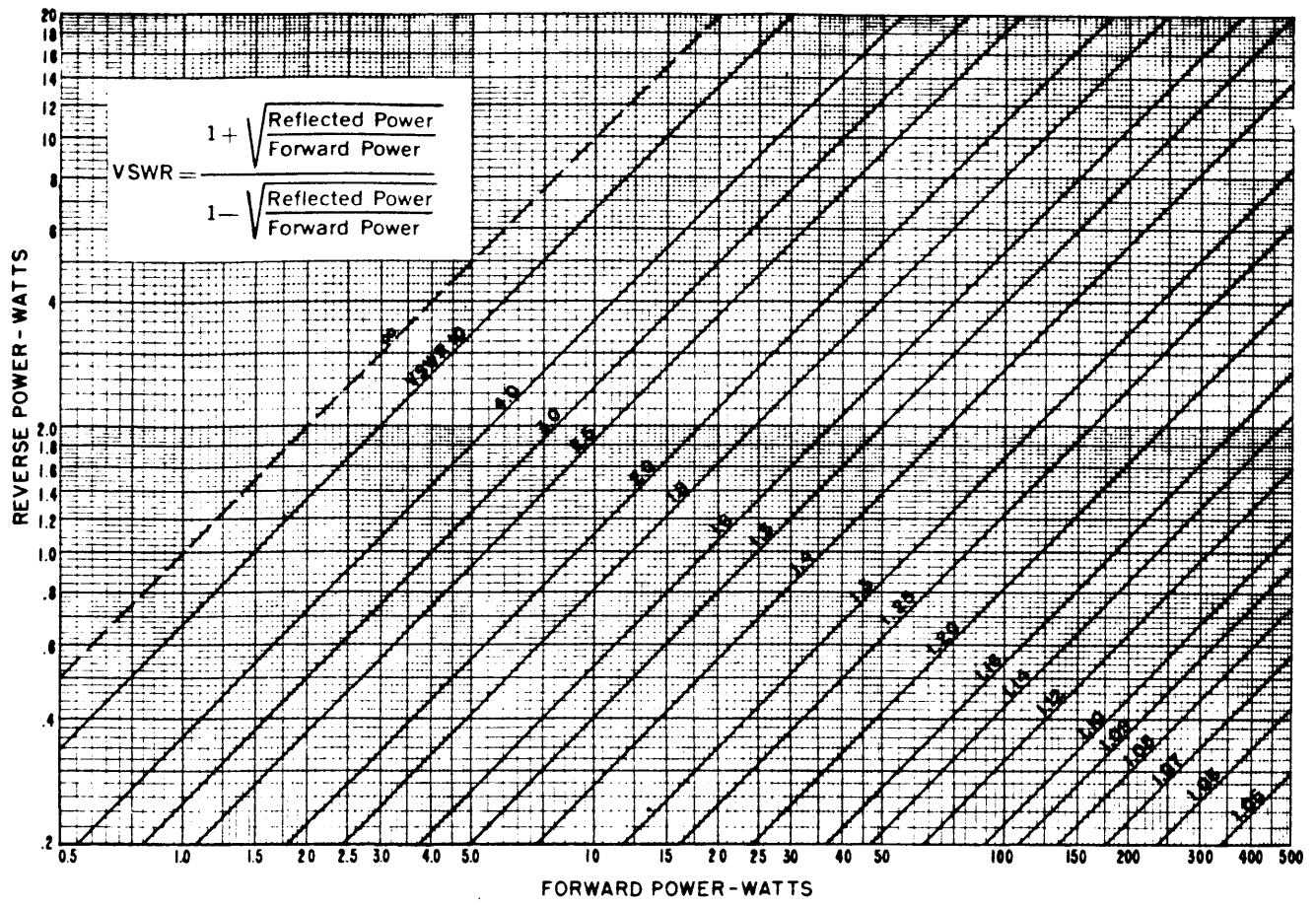

Figure 5-2. VSWR Nomograph



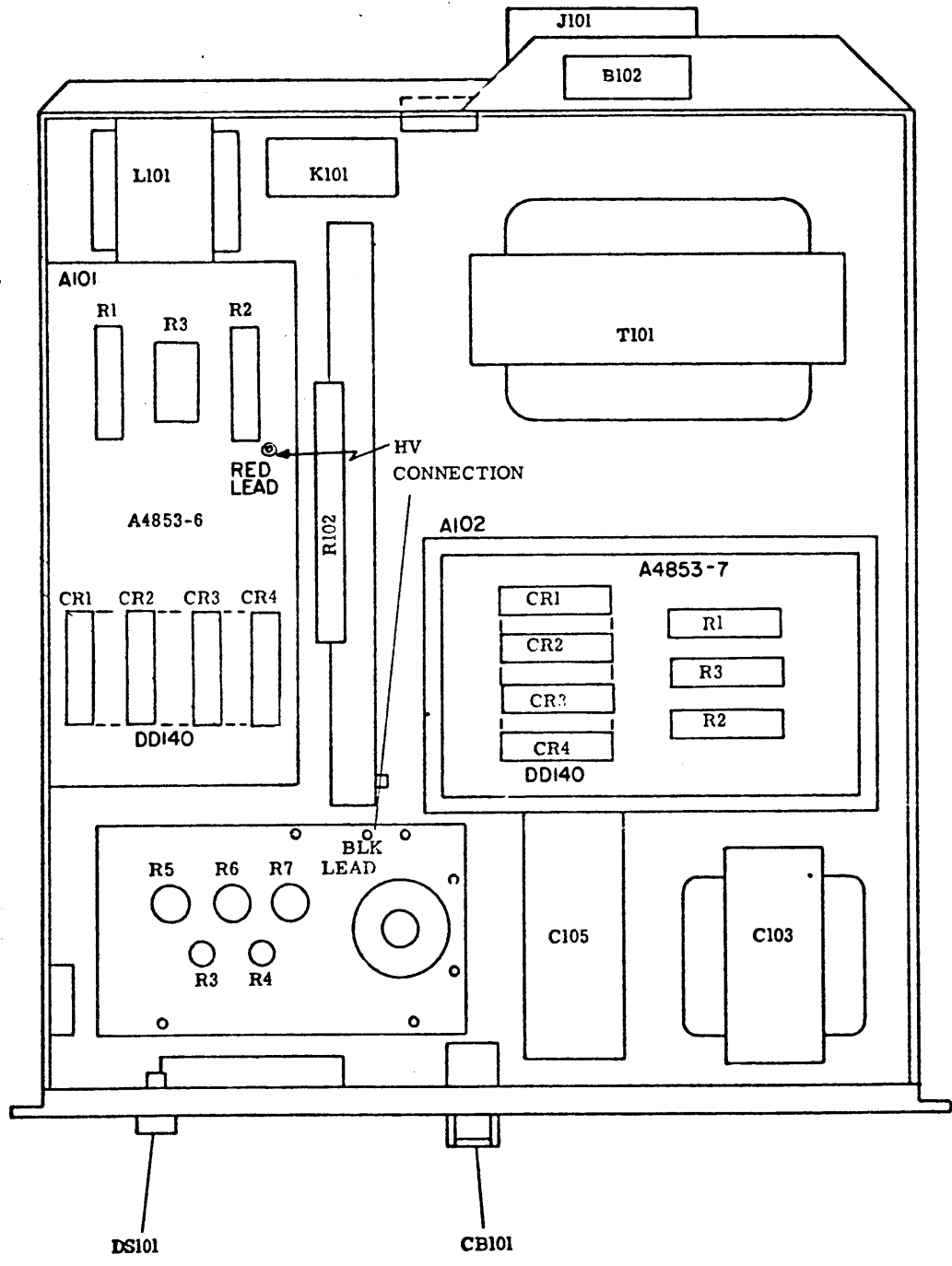

Figure 5-3. AP-152 Top View

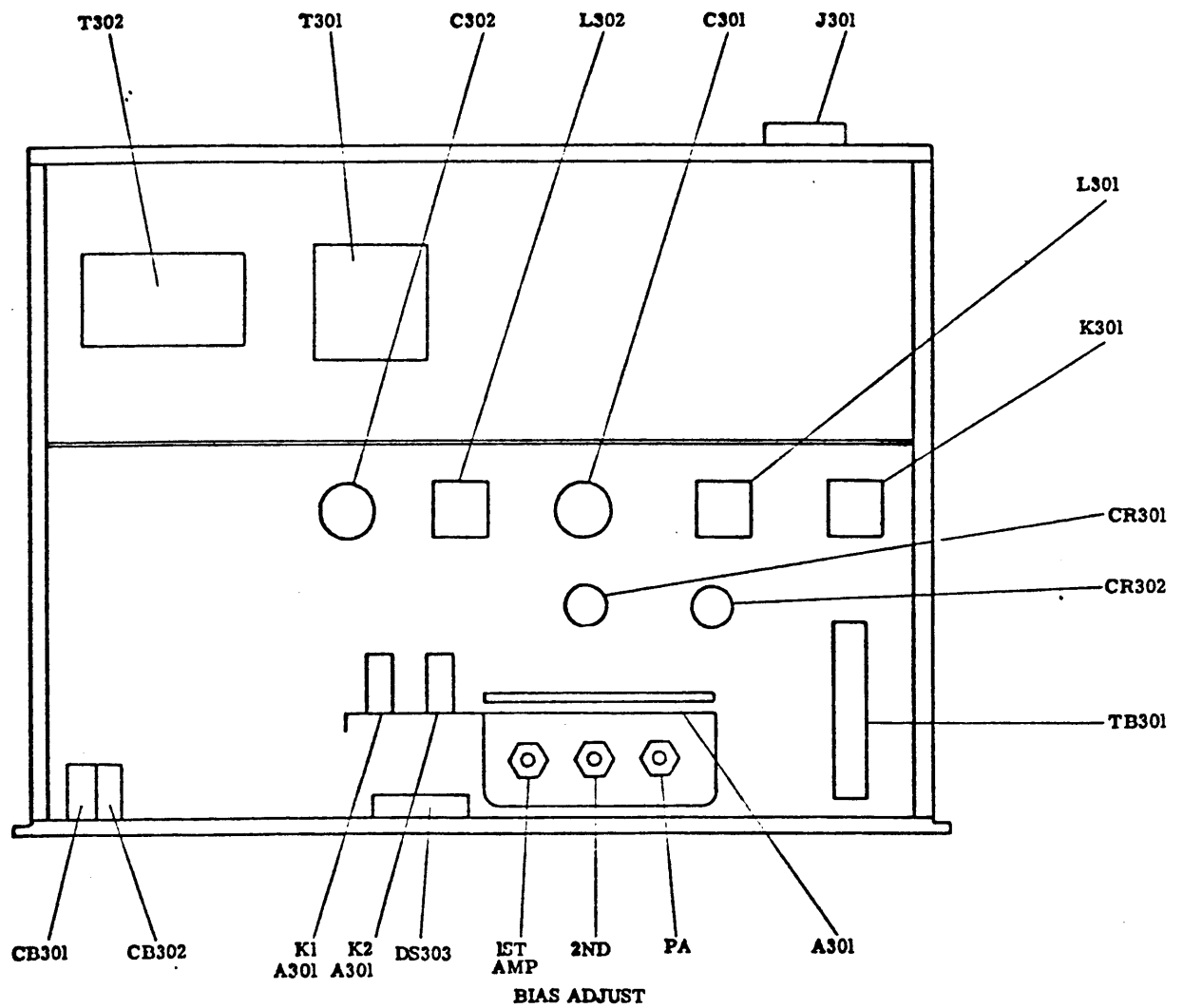

Figure 5-4. AP-151 Top View

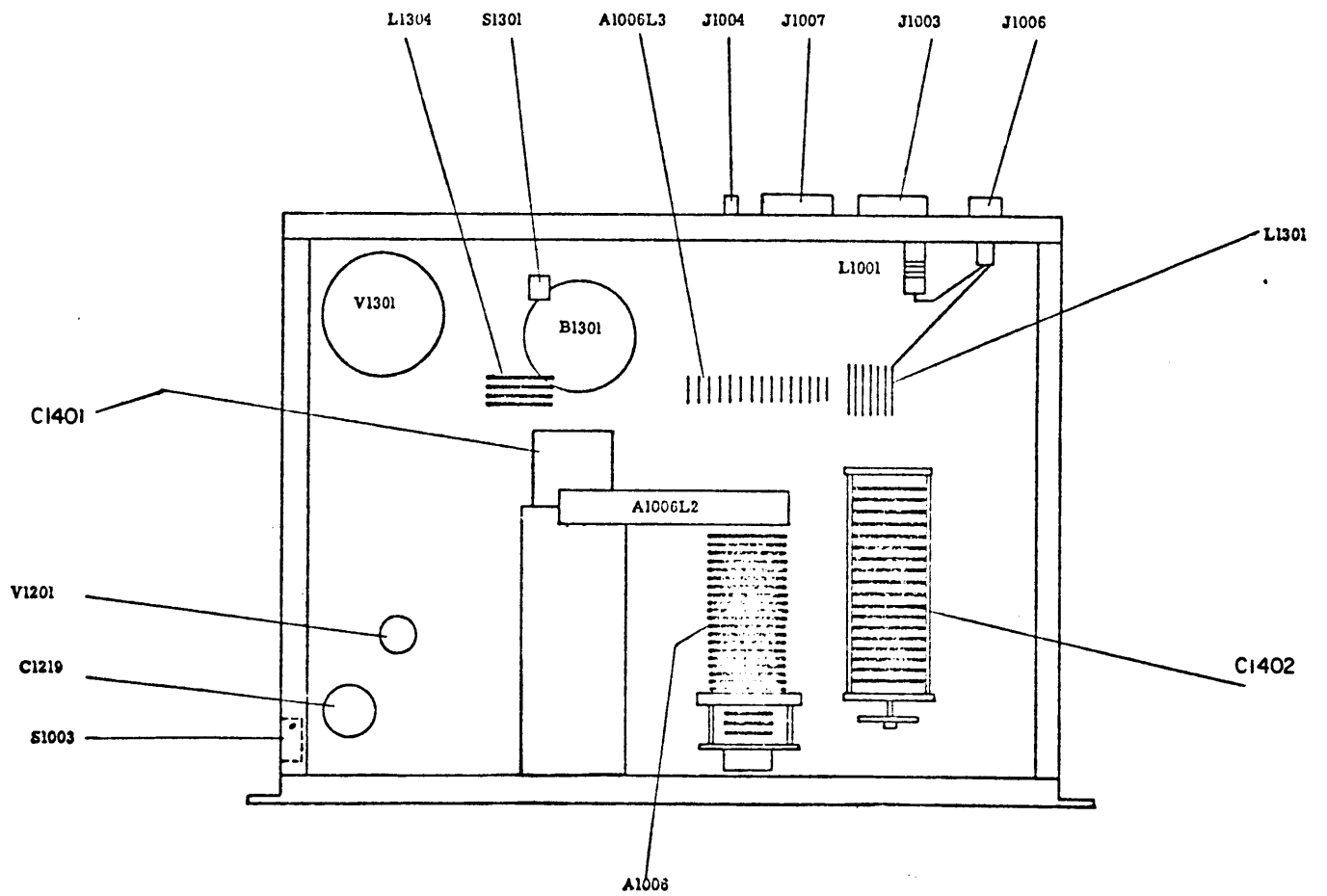

Figure 5-5. TLAM-1KA Top View

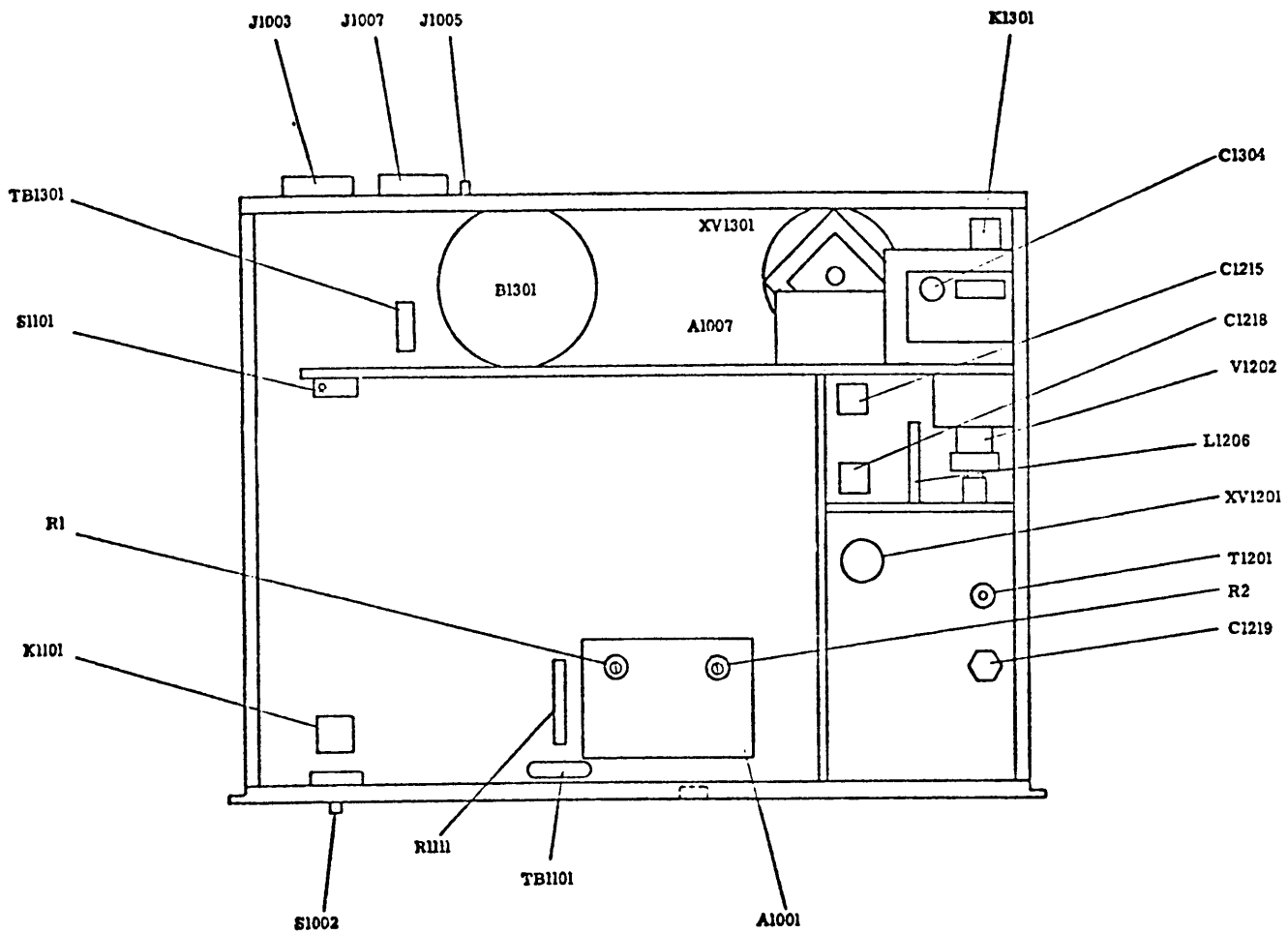

Figure 5-6. TLAM-1KA Bottom View

SECTION 6  
PARTS LIST

6-1. INTRODUCTION

Reference designations have been assigned to identify all electrical parts of the equipment. These designations are used for marking the equipment (adjacent to the part they identify) and are included on drawings, diagrams and the parts list. The letters of a reference designation indicate the kind of part (generic group), such as resistor, capacitor, transistor, etc. The number differentiates between parts of the same generic group. Sockets associated with a particular plug-in device, such as transistor or fuse, are identified by a reference designation which includes the reference designation of the plug-in device. For example, the socket for relay K201 is designated XK201. The assemblies and/or sub-assemblies that are a part of a major assembly are suffixed with an asterisk; parts list breakdown for these assemblies are located in the rear of the parts section. For example, in parts list for Power Amplifier, the Reference Symbol A1001 shows a TMC part number A4879\*, the parts list breakdown for A4879 is located in the rear of parts list for TLAM-1KA. To expedite delivery when ordering replacement parts, specify the TMC part number and the model number of the equipment. See example below.

To order C1 of A4879, order as follows:

A4879 C1, TMC Part No. CX119-104M.

<u>Title</u>	<u>Page</u>
H.V. Power Supply AP152 (Symbol Series 100) . . . . .	6-2
L.V. and Bias Supply AP151 (Symbol Series 300). . . . .	6-4
RF Linear Power Amplifier TLAM-1KA (Symbol Series 1000) . . . . .	6-7

AP152 H/V Power Supply

REF SYMBOL	DESCRIPTION	TMC PART NUMBER
A101	Assembly, PC, Board, Rect	A-4853-6*
A102	Assembly, PC, Board, Rect	A-4853-7*
A103	Assembly, PC, Board, Zener	A5637*
B101	Fan, Vent	BL106-2
B102	Same as B101	
C101	Capacitor, Fixed, Film	CN128-1
C102 thru C104	Same as C101	
C105	Capacitor, Fixed, Paper	CP70B1EG106K
CB101	Circuit, Breaker	SW261
DS101	Lamp, Incand	BI105-1
DS102	Same as DS101	
F101	Fuse, Circuit	FU102-500
K101	Rel, Arm	RL184-3
L101	React, 5H	TF5034
L102 thru L104	Same as L101	
R101	Res, Fixed, WW 160W	RW117-39
R102	Same as R101	
R103	Resistor, Fxd, WW 55W	RW115-101-55
T101	Xfmr, Pl	TF413
TB101	Terminal, Bd, Barr	TM102-4
XDS101	Socket, Lamp	TS136-2FS
XDS102	Socket, Lamp	TS136-1FS
XF101	Fuse holder	FH105
XK101	Soc, Rel	TS196-1
Z101	Shunt, Circuit, Breaker	AR196
Z102	Shunt, Circuit, Breaker	AR197

AP152 H/V Power Supply (con't)

REF SYMBOL	DESCRIPTION	TMC PART NUMBER
	<b>A-4853-6 Assembly, Board, PC Rect</b>	
A101CR1 thru A101CR4	Rect, Scnd, Dev	DD140
A101R1	Resistor, Fixed, WW 10W	RW109-4
A101R2	Same as A101R1	
A101R3	Resistor, Fixed, WW 20W	RW110-3
	<b>A-4853-7 Assembly, Board, PC Rect</b>	
A102CR1 thru A102CR4	Rect, Scnd, Dev	DD140
A102R1	Resistor, Fixed, WW 10W	RW109-4
A102R2	Same as A102R1	
A102R3	Resistor, Fixed, WW 20W	RW110-7
	<b>A5637 Assembly, Board, PC Zener</b>	
A103CR1	Scnd, Dev, Dio	1N2846A
A103CR2	Same as A103CR1	
A103R1	Resistor, Fixed, Comp	RC42GF274J
A103R2	Resistor, Fixed, Comp	RC42GF124J
A103R3	Resistor, Fixed, Comp	RC42GF101J
A103R4	Resistor, Fixed WW 50W	RW105-32
A103R5	Same As A103R4	
A103R6	Same As A103R4	
A103R8	Same As A103R3	
A103R9	Same as A103R3	

AP151 L/V and Bias Supply

REF SYMBOL	DESCRIPTION	TMC PART NUMBER
A301	Board, Assembly, Pc, Bias	A-4877*
C301	Capacitor, Fixed, Elec	CE52C200Q
C302	Same as C301	
C303	Capacitor, Fixed, Elec	CE116-8VN
C304	Same as C303	
CB301	Circuit, Breaker	SW262
CB302	Circuit, Breaker	SW215
CR301	Scond, Dev, Dio	1N2843RA
CR302	Scond, Dev, Dio	1N2831RA
CR303	Scond, Rect	RX108-2
CR304	Scond, Dev, Dio	1N3321B
CR305	Scond, Dev, Dio	1N3324B
DS301	Lamp, Incand	BI110-7
DS302	Same as DS301	
DS303	Gen, Audio, Sig.	BZ101-2
F301	Fuse, Cartridge (115V operation only)	FU102-1.5
F301	Fuse, Cartridge (230V operation only)	FU102-.75
F302	Fuse, Cartridge (115V operation only)	FU102-2
F302	Fuse, Cartridge (230V operation only)	FU102-1
F303	Same as F301	
F304	Fuse, Cartridge	FU102-.2
F305	Fuse, Cartridge	FU100-4
F306	Fuse, Cartridge	FU102-2.5
J301	Conn, Recep, ML	MS3102A32-414P
K301	Rel, Arm.	RL168-3C10-24DC
L301	React. 5H	TF5028
L302	Same as L301	
R301	Res, Fxd, WW 10W	RW109-19
R302	Res, Fxd, Comp	RC42GF474J
R303	Res, Fxd, Comp	RC20GF103J
R304	Res, Fxd, WW 10W	RW109-1
R305	Same as R304	
R306	Res, Fxd, WW 20W	RW110-5



AP151 L/V and Bias Supply

REF SYMBOL	DESCRIPTION	TMC PART NUMBER
R307	Same as R304	
R308	Res, Fxd, Comp	RC42GF392J
R309	Res, Fxd, WW 20W	RW110-5
R310	Res, Fxd, Comp	RC42GF101J
R311	Same as R310	
R312	Same as R309	
S301	Switch, Toggle, SPST	ST103-5-62
S302	Switch, Push, DPDT	SW522-1
T301	Transformer, Fil	TF414
T302	Transformer, L/V	TF416
TB301	Terminal, Strip, Barr	TM100-8
XA301	Conn, Pc, Board	JJ319-22DFE
XC301	Socket, Octal	TS101P01
XC302	Same as XC301	
XCR301	Soc, Scond, Dev	TS166-1
XCR302	Same as XCR301	
XDS301	Light, Ind	TS153-11
XDS302	Light, Ind	TS184
XF301	Fuseholder	FH104-3
XF302	Same as XF301	FH104-3
XF303	Same as XF301	
XF304	Same as XF301	
XF305	Fuseholder	FH104-11
XF306	Same as XF305	
XK301	Same as XC301	

A-4877 Board, Assembly, PC Bias

REF SYMBOL	DESCRIPTION	TMC PART NUMBER
CR1	Rect, Scond, Dev	DD130-600-1.5
CR2	Scond, Dev, Dio	1N645
CR3 thru CR10	Same as CR2	
K1	Rel, Arm 4PDT	RL156-15
K2	Rel, Arm 4PDT	RL156-10
R1	Res, Fxd, Comp	RC42GF100J
R2	Same as R1	
R3	Res, Fxd, Comp	RC42GF122J
R4	Res, Var, Comp	RV4LAYS252A
R5	Res, Fxd, Comp	RC42GF101J
R6	Res, Fxd, Comp	RC42GF332J
R7	Res, Var, Comp	RV4LAYS502A
R8	Res, Fxd, Comp	RC42GF151J
R9	Res, Fxd, Comp	RC42GF472J
R10	Res, Var, Comp	RV4LAYS103A
R11	Res, Fxd, Comp	RC42GF123J
R12	Res, Fxd, Comp	RC32GF122J
R13	Res, Fxd, Comp	RC32GF152J
R14	Same as R12	
R15	Same as R13	
XK1	Soc, Rel	TS171-4
XK2	Same as XK1	

TLAM-1KA RF Linear Power Amplifier

REF SYMBOL	DESCRIPTION	TMC PART NUMBER
A1001	Printed Circuit Board Assembly	A-4879*
A1002	Not used	
A1003	Not used	
A1004	Printed Circuit Board Assembly	A-4878*
A1005	Printed Circuit Board Assembly	A-4850-2*
A1006	Bandswitch Assembly	AS160*
A1007	Not used	
A1008 C1001 thru C1004	Matching Network Assembly Capacitor, Fxd, Polyester	AX787* CX119-104M
C1005	Capacitor, Fxd, Cer	CC109-3
C1006	Capacitor, Fxd, Mica	CM15B151J03
DC1001	Coupler, Directional	DC108
DS1001	Lamp, Incand	BI101-1820
DS1002	Same as DS1001	
J1001	Conn, Recp, ML	MS3102A-18-16P
J1002	Conn, Recp, Fml	MS3102A18-16S
J1003	Conn, Recp, ML	MS3102A32-7P
J1004	Conn, Recp, BNC	JJ172
J1005	Same as J1004	
J1006	Conn, Recp, HN	UG560*/U
J1007	Conn, Recp, ML	MS3102A32-414P
J1008	Conn, Recp, FML	JJ310-3
L1001	Coil, RF	CL138
M1001	Meter, FL	MR216-1

TLAM-1KA RF Linear Power Amplifier (con't)

REF SYMBOL	DESCRIPTION	TMC PART NUMBER
M1002	Meter, Output	MR217
S1001	Switch, Lever	SW523-3
S1002	Switch, Actuator	SW347
S1003	Switch, Intlk	SW219
XA1001	Conn, Recp, PC Board	JJ319-22-DFE
XDS1001	Lamp, Holder, Bay	TS107-2
XDS1002	Same as XDS1001	
C1101 thru C1107	Capacitor, Fxd, Cer	CK70AW202M
C1108	Capacitor, Fxd, Cer	CC108-4P-1000M
C1109	Same as C1108	
C1110	Not used	
C1111	Not used	
C1112	Capacitor, Fxd, Cer	CK70AW202M
C1113	Not used	
C1114	Not used	
C1115	Not used	
C1116	Capacitor, Fxd, Elec	CE105-25-25
C1117	Capacitor, Fxd, Elec	CE105-10-50
CR1101	Not used	
CR1102	Not used	
E1101	Not used	
E1102	Bush, Slot Heat	TE101-3

TLAM-1KA RF Linear Power Amplifier (con't)

REF SYMBOL	DESCRIPTION	TMC PART NUMBER
E1103	Term, Turret	TE102-2
E1104	Bush, Slot Head	TE101-3
E1107	Same as E1103	
E1108	Same as E1103	
K1101	Rel, Arm, DPDT	RL156-1
R1101 thru R1103	Resistor, Fxd, Comp	RR114-5W
R1104	Resistor, Fxd, Comp	RC42GF100J
R1105	Resistor, Fxd, WW	RW111-4
R1106	Not used	
R1107	Resistor, Fxd, Comp	RC32GF102J
R1108	Resistor, Fxd, Comp	RC20GF103J
R1109	Resistor, Var, Comp	RV106UX10C102A
R1110	Resistor, Fxd, Comp	RC20GF101J
R1111	Resistor, Fxd, WW	RW110-1
R1112	Resistor, Fxd, Comp	RC42GF102J
R1113	Resistor, Fxd, Comp	RC42GF821J
S1101	Switch, Intlk	SW219
TB1101	Terminal, Strip	TM121-1
XK1101	Socket, Relay	TS171-1
Z1101	Time, Delay	NW183-24-30
C1201	Capacitor, Fxd, Mica	CM111C181J5S
C1202	Capacitor, Fxd, Cer	CC100-16
C1203	Capacitor, Fxd, Cer	CC100-37
C1204	Capacitor, Fxd, C r	CC100-32
C1205	Same as C1204	

TLAM-1KA RF Linear Power Amplifier (con't)

REF SYMBOL	DESCRIPTION	TMC PART NUMBER
C1206	Capacitor, Fxd, Cer	CC100-31
C1207	Capacitor, Fxd, Mica	CM111E220J5S
C1208	Capacitor, Fxd, Mica	CM112F222F3S
C1209 thru C1212	Same as C1203	
C1213 C1214	Capacitor, Fxd, Cer Same as C1213	CC100-23
C1215	Capacitor, Fxd, Cer	CC109-38
C1216	Same as C1204	
C1217	Same as C1203	
C1218	Same as C1215	
C1219	Capacitor, Fxd, Paper	CP41B1EF405K
C1220	Same as C1203	
E1201 thru E1208	Term, Turret	TE102-2
L1201	Not used	
L1202	Coil, RF	CL101-2
L1203 thru L1205	Coil, RF	CL140-2
L1206	Ind, Fxd	CL459
L1207	Coil, RF	CL178
R1201	Resistor, Fxd, Comp	RC20GF102J
R1202	Resistor, Fxd, Comp	RC32GF100J
R1203	Resistor, Fxd, Comp	RC42GF120J
R1204	Resistor, Fxd, Comp	RC42GF222J

TLAM-1KA RF Linear Power Amplifier (con't)

REF SYMBOL	DESCRIPTION	TMC PART NUMBER
R1205	Resistor, Fxd, Comp	RC20GF333J
R1206	Resistor, Fxd, Comp	RC42GF331J
R1207	Resistor, Fxd, Comp	RC42GF472J
R1208	Resistor, Fxd, Comp	RR114-20W
R1209	Resistor, Fxd, Comp	RC20GF101J
R1210	Same as R1209	
R1211	Resistor, Fxd, Comp	RC42GF183J
R1212	Resistor, Fxd, Comp	RC42GF154J
R1213	Same as R1212	
R1214	Resistor, Fxd, WW 10W	RW109-30
T1201	Coil, RF, Adj	CL460
V1201	Tube, E1	8233
V1202	Tube, E1	4CX350A
XV1201	Socket, E1 Tube	TS198
XV1202	Socket, E1 Tube	TS197
Z1201	Supp, Parasitic	A1546-2
Z1202	Supp, Parasitic	A1546-4
B1301	Blower, Cent	BL134
C1301	Not Used	
C1302	Not Used	
C1303	Not Used	
C1304	Not Used	
C1305	Not Used	
C1306	Not Used	
C1307	Capacitor, Fxd, Cer	CC100-32
C1308	Same as C1307	
C1309	Capacitor, Fxd, Cer	CC100-37
C1310	Capacitor, Fxd, Cer	CC109-38

TLAM-1KA RF Linear Power Amplifier (con't)

REF SYMBOL	DESCRIPTION	TMC PART NUMBER
C1311 thru C1314	Capacitor, Fxd, Cer	CC109-36
C1316	Not used	
C1317 thru C1321	Not used	
C1322	Same as C1310	
C1323	Same as C1310	
E1301	Term, Turret	TE102-2
E1302	Ins, Standoff	NS3W0108
L1301	Coil, Output	CL463
L1302	Coil, RF	CL140-6
L1303	Same as L1302	
L1304 L1305	Coil, RF Coil, RF	CL471 CL140-1
R1302	Resistor, Fxd, Comp	RR114-5W
R1303	Same as R1301	
S1301	Switch, Micro	SW252
TB1301	Term, Strip, Barr	TM102-6
V1301	Tube, E1	8576/PL264J
XV1301	Socket, E1, Tube	TB182



A-4879 Printed Circuit Board Assembly

REF SYMBOL	DESCRIPTION	TMC PART NUMBER
C2 thru C17	Capacitor, Fixed, Polyester	CC100-28
C18	Not used	
C19 thru C21	Same as C3	
C22	Capacitor, Fixed, Mica	CM111C200J5S
C23	Capacitor, Fixed, Mica	CM111E511H5S
C24	Capacitor, Fixed, Elec	CE105-3-25
C25	Same as C.3	
C26	Capacitor, Fxd, Elec	CE105-50-15
C27	Capacitor, Fxd, Elec	CE105-20-15
CR1	Scond, Dev, Dio	1N759
CR2	Same as CR1	
CR3 thru CR5	Scond, Dev, Dio	1N2484
CR6 thru CR9	Scond, Dev, Dio	1N645
CR10	Not Used	
CR11	Same as CR3	
L1	Coil, RF	CL240-120
L2	Same as L1	
Q1	Transist r	2N492A
Q2	Transistor	2N1595

A-4879 Printed Circuit Board Assembly (con't)

REF SYMBOL	DESCRIPTION	TMC PART NUMBER
Q3	Same as Q2	
R1	Resistor, Var, Comp	RV111U502A
R2	Resistor, Var, Comp	RV111U103A
R3	Resistor, Fixed, Comp	RC20GF152J
R4	Resistor, Fixed, Comp	RC20GF102J
R5	Resistor, Fixed, Comp	RC20GF153J
R6	Resistor, Fixed, Comp	RC20GF391J
R7	Same as R6	
R8	Same as R4	
R9	Resistor, Fixed, Comp	RC20GF821J
R10	Resistor, Fixed, Comp	RC20GF560J
R11	Resistor, Fixed, Comp	RC20GF122J
R12	Not used	
R13	Not used	
R14	Not used	
R15	Not used	
R16	Not used	
R17	Not Used	
R18	Not Used	
R19	Not Used	
R20	Resistor, Fixed, Comp	RC20GF224J
R21	Resistor, Fixed, Comp	RC20GF104J
R22	Resistor, Fixed, Comp	RC07GF562J
Z1	Network, OP Amp	NW156

PA Tune, Load Capacitors

REF SYMBOL	DESCRIPTION	TMC PART NUMBER
C1401	Capacitor, Var, Vac	CB178
C1402	Capacitor Var. Air	CB175

A-4878 Printed Circuit Board Assembly

REF SYMBOL	DESCRIPTION	TMC PART NUMBER
C1 thru C9	Capacitor, Fxd, Polyester	CX119-104M
CR1 thru CR9	Scond, Dev, Dio	1N645
DS1 thru DS9	Lamp, Incand	BI114-2
E1 thru E10	Terminal, Stud	TE127-2
R1	Resistor, Fxd, Comp	RC32GF391J

A-4850-2 Printed Circuit Board Assembly

REF SYMBOL	DESCRIPTION	TMC PART NUMBER
C1	Capacitor, Fixed, Cer	CC100-28
C2	Same as C1	
C3	Capacitor, Fixed, Elec	CE107-6
CR1	Scond, Dev, Dio	1N34A
E1 thru E3	Terminal, Stud	TE127-2
R1	Resistor, Fixed, Comp	RC20GF272J
R2	Resistor, Fixed, Comp	RC20GF102J

AS160 Band Switch Assembly

REF SYMBOL	DESCRIPTION	TMC PART NUMBER
C1 thru C6	Capacitor, Fixed, Cer	CC109-38
C7	Capacitor, Fixed, Cer	CC109-28
C8	Capacitor, Fixed, Cer	CC109-19
CR1	Scnd, Dev, Dio	1N547
E1	Term, Turret	TE102-2
E2	Same as E1	
K1	Rel, Arm, DPDT	RL168-2C10-24DC
L1	Coil, Rf	CL292
L2	Coil, MN, Tank	CL470
L3	Coil. Load	CL472
P1	Conn, PL, ML, 37/C	JJ313-3H
S1A	Assembly, Bnd, Bd	BMA464
S1B	Assembly, Output, Bd	BMA465
S2	Switch, Rotary, Solenoid	SW429
XK1	Socket, Relay	TS100-3

AX787 Matching Network

REF SYMBOL	DESCRIPTION	TMC PART NUMBER
C1	Cap., Variable	CV111D450
C2	Cap., Fxd, Mica	CM111C151J5S
C3	Cap.; Fxd, Ceramic	CC100-28
C4	Same as C3	
C5	Same as C3	
C6	Same as C3	
C7	Cap., Fxd, Mica	CM112F562J5S
CR1	Scnd, Dev, Dio	1N645
K1	Relay, Armature	RL185
K2	Same as K1	
K3	Same as K1	
L1	Choke, RF	CL105-2
R1	Res, Fxd	RR116-1400W
T1	XFMR, Interstage	TR206

SECTION 7

MAINTENANCE DIAGRAMS

7-1. GENERAL

This section contains the following maintenance diagrams for HFLM-1KA.

<u>Figure</u>		<u>Page</u>
7-1	Low Voltage and Bias Supply AP151 Schematic Diagram - . . . . .	7-2
7-2	High Voltage Power Supply AP152 Schematic Diagram - . . . . .	7-3
7-3	Power Amplifier TLAM-1KA Schematic Diagram - . . . . . (3 sheets)	7-4



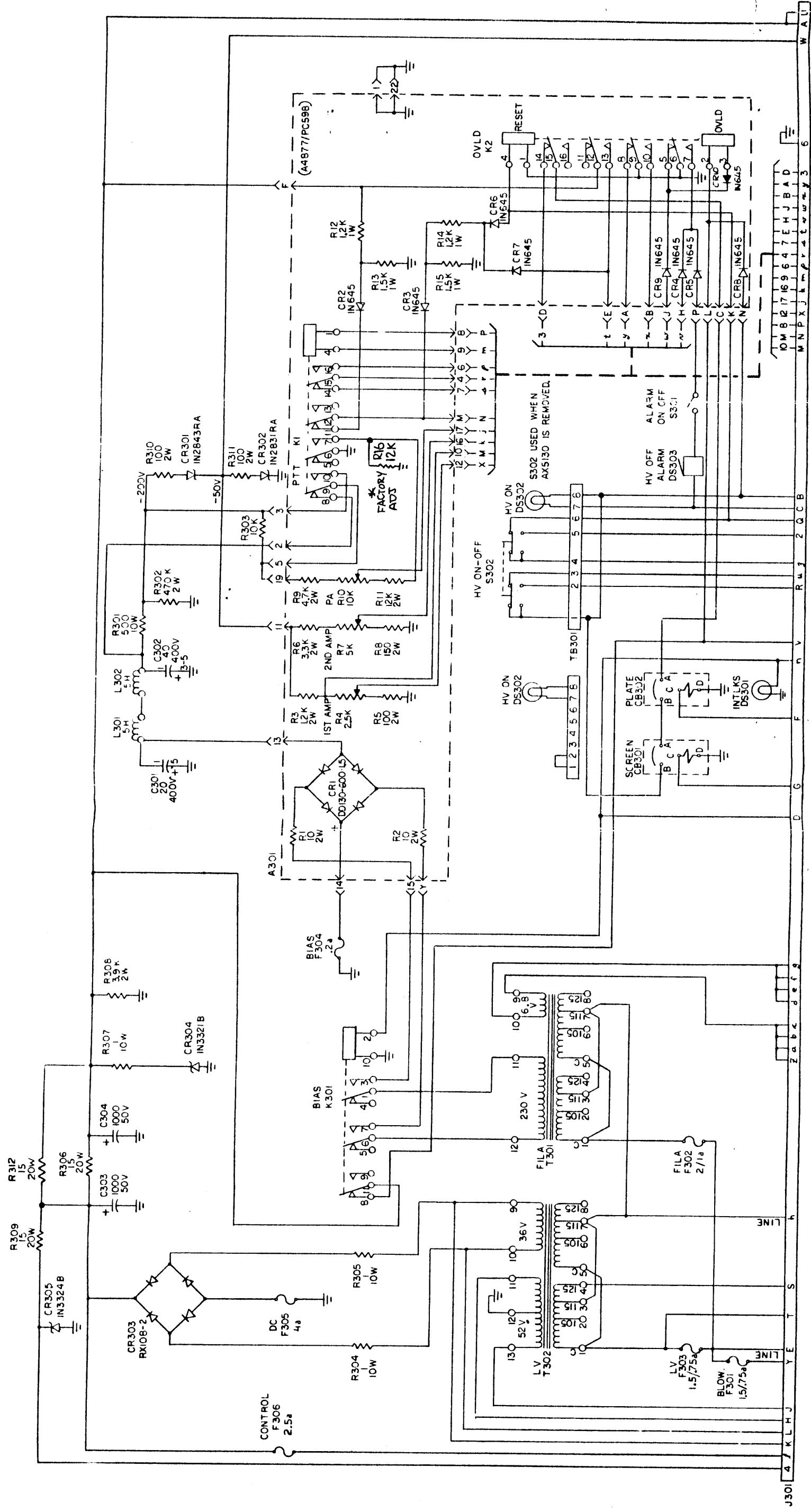

- UNLESS OTHERWISE SPECIFIED:
1. ALL RESISTANCES ARE IN OHMS,  $\frac{1}{2}$  W.
  2. ALL CAPACITANCES ARE IN MFD.
  3. ALL INDUCTANCES ARE IN MH.
  4. AC FUSE VALUES SHOWN FOR 115/230 V OPERATION.
  5. TRANSFORMERS SHOWN WIRED FOR 115V. FOR OTHER VOLTAGES CHANGE LINE # JUMPS TO CORRESPOND.
  6. PARTIAL REFERENCE DESIGNATIONS ARE SHOWN FOR COMPLETE DESIGNATION PREFIX THE PART DESIGNATION WITH THE SUB-ASSEMBLY DESIGNATION.

Schematic Diagram,  
Low Voltage and Bias Supply AP151

(CK1870-E)

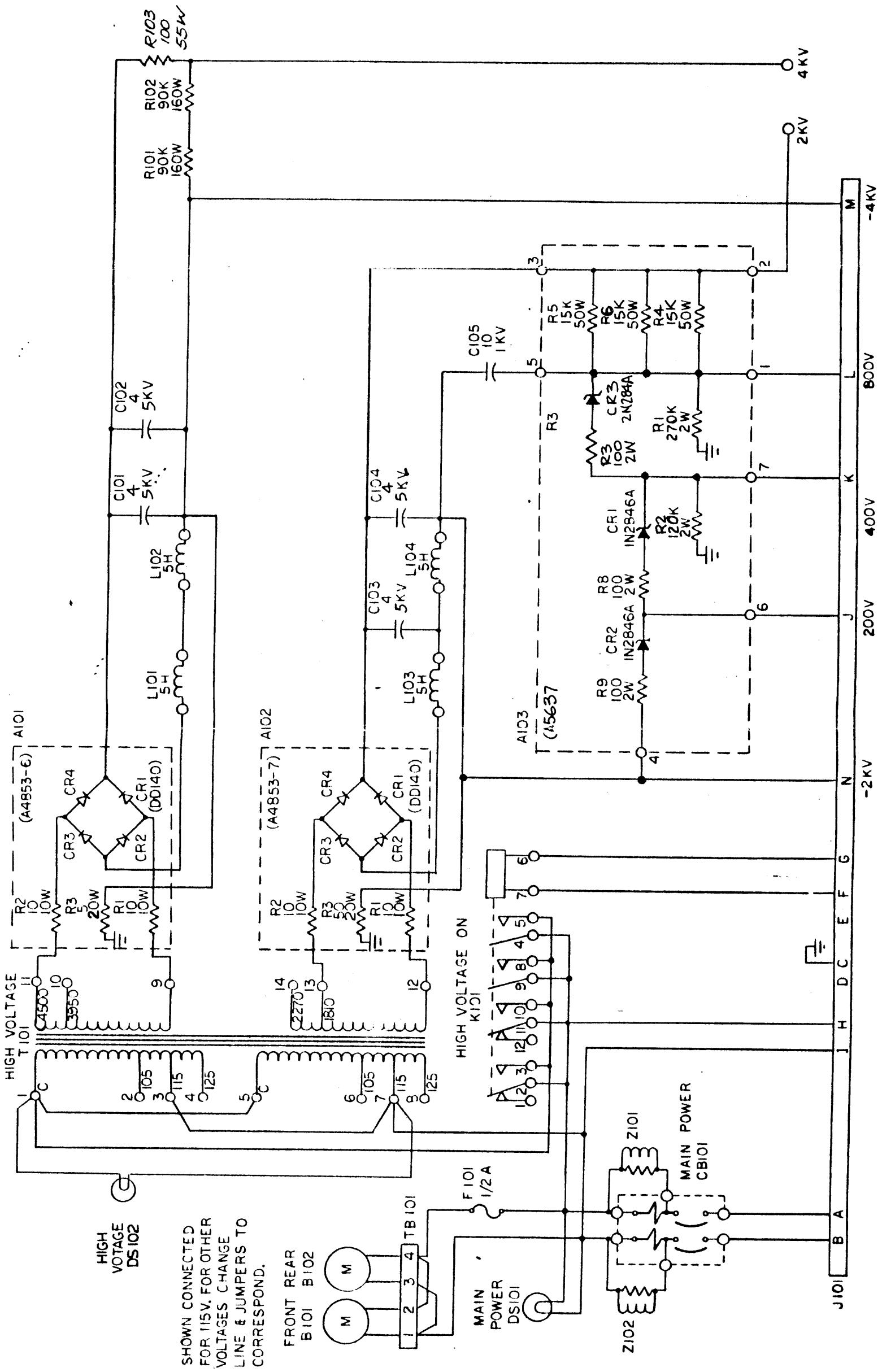

Schematic Diagram,  
High Voltage Power Supply AP152

(CK1869H)

J1003

TB1101 24 VDC

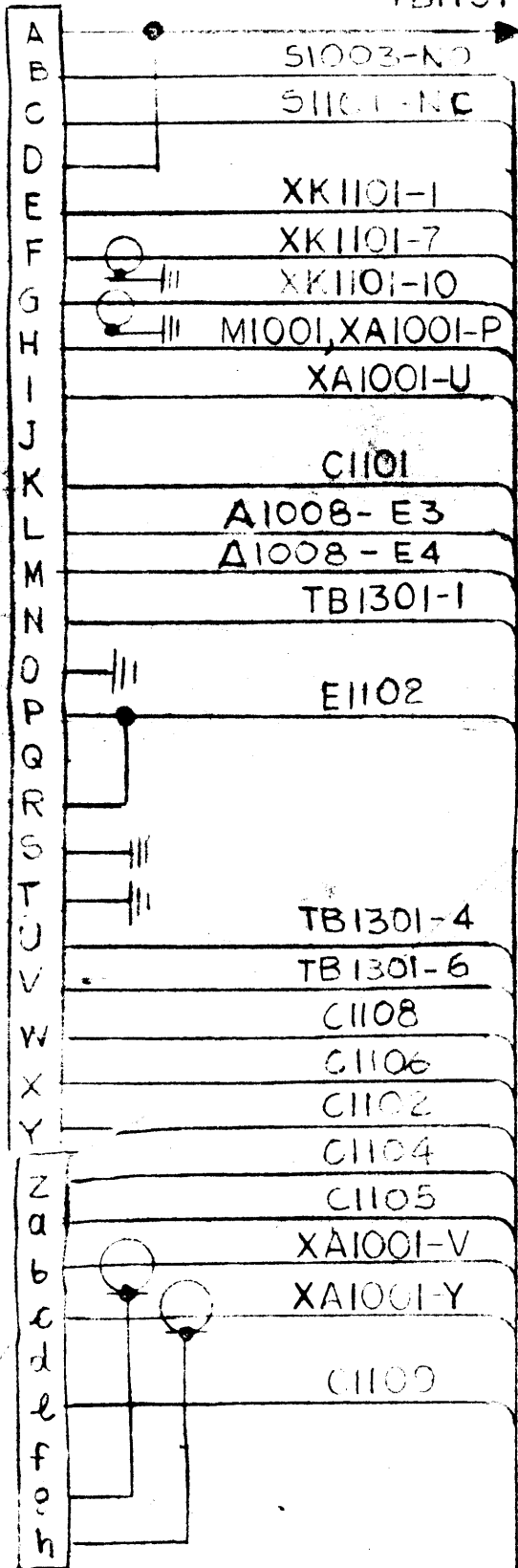

J1001



J1002

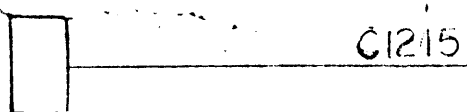

REF IN  
J1003

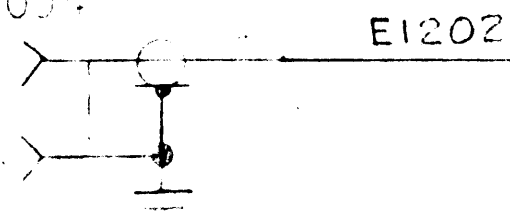

ALDC  
J1003

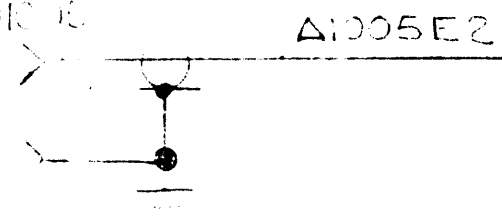

J1007

XK1101-5

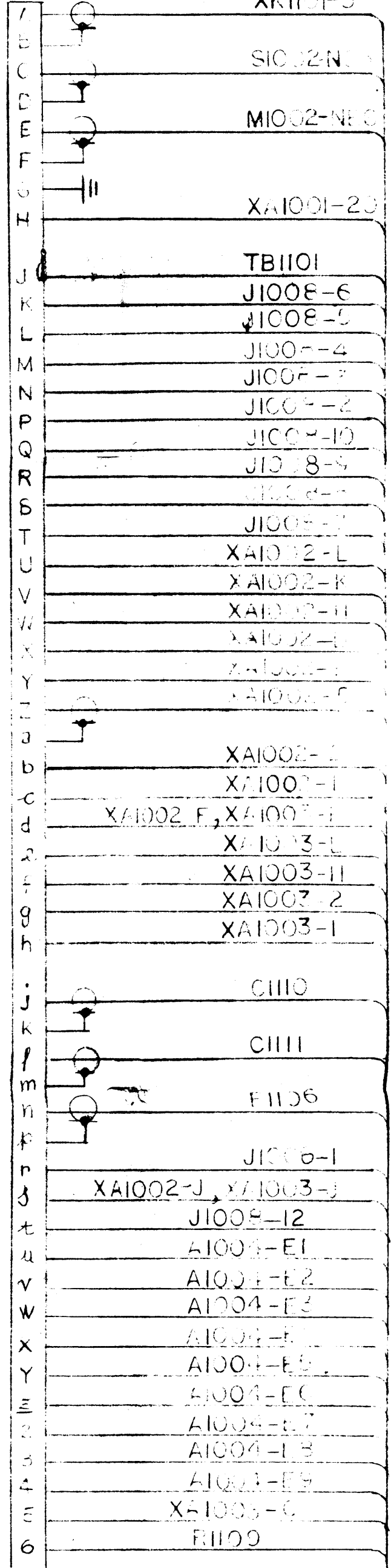

TB1101  
24 VDC

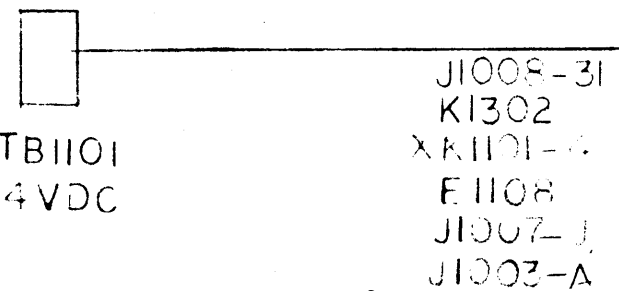

- XK111-5
- SIC02-N
- MIC02-NEC
- XA1001-20
- TB1101
- J100E-6
- J100E-5
- J100E-4
- J100E-7
- J100E-2
- J100E-10
- J100E-8-9
- J100E-11
- XA1002-L
- XA1002-F
- XA1002-H
- XA1002-I
- XA1002-J
- XA1002-K
- XA1002-L
- XA1002-M
- XA1002-N
- XA1002-O
- XA1002-P
- XA1002-Q
- XA1002-R
- XA1002-S
- XA1002-T
- XA1002-U
- XA1002-V
- XA1002-W
- XA1002-X
- XA1002-Y
- XA1002-Z
- C1110
- C1111
- E1106
- J1006-1
- J1006-2
- J1006-3
- J1006-4
- J1006-5
- J1006-6
- J1006-7
- J1006-8
- J1006-9
- J1006-10
- J1006-11
- J1006-12
- A1004-E1
- A1004-E2
- A1004-E3
- A1004-E4
- A1004-E5
- A1004-E6
- A1004-E7
- A1004-E8
- A1004-E9
- A1004-E10
- A1004-E11
- A1004-E12
- A1004-E13
- A1004-E14
- A1004-E15
- A1004-E16
- A1004-E17
- A1004-E18
- A1004-E19
- A1004-E20
- R1109
- J1008-31
- K1302
- XK1101-1
- E1108
- J1007-1
- J1007-2
- J1007-3
- J1007-4
- J1007-5
- J1007-6
- J1007-7
- J1007-8
- J1007-9
- J1007-10
- J1007-11
- J1007-12
- J1007-13
- J1007-14
- J1007-15
- J1007-16
- J1007-17
- J1007-18
- J1007-19
- J1007-20
- J1007-21
- J1007-22
- J1007-23
- J1007-24
- J1007-25
- J1007-26
- J1007-27
- J1007-28
- J1007-29
- J1007-30

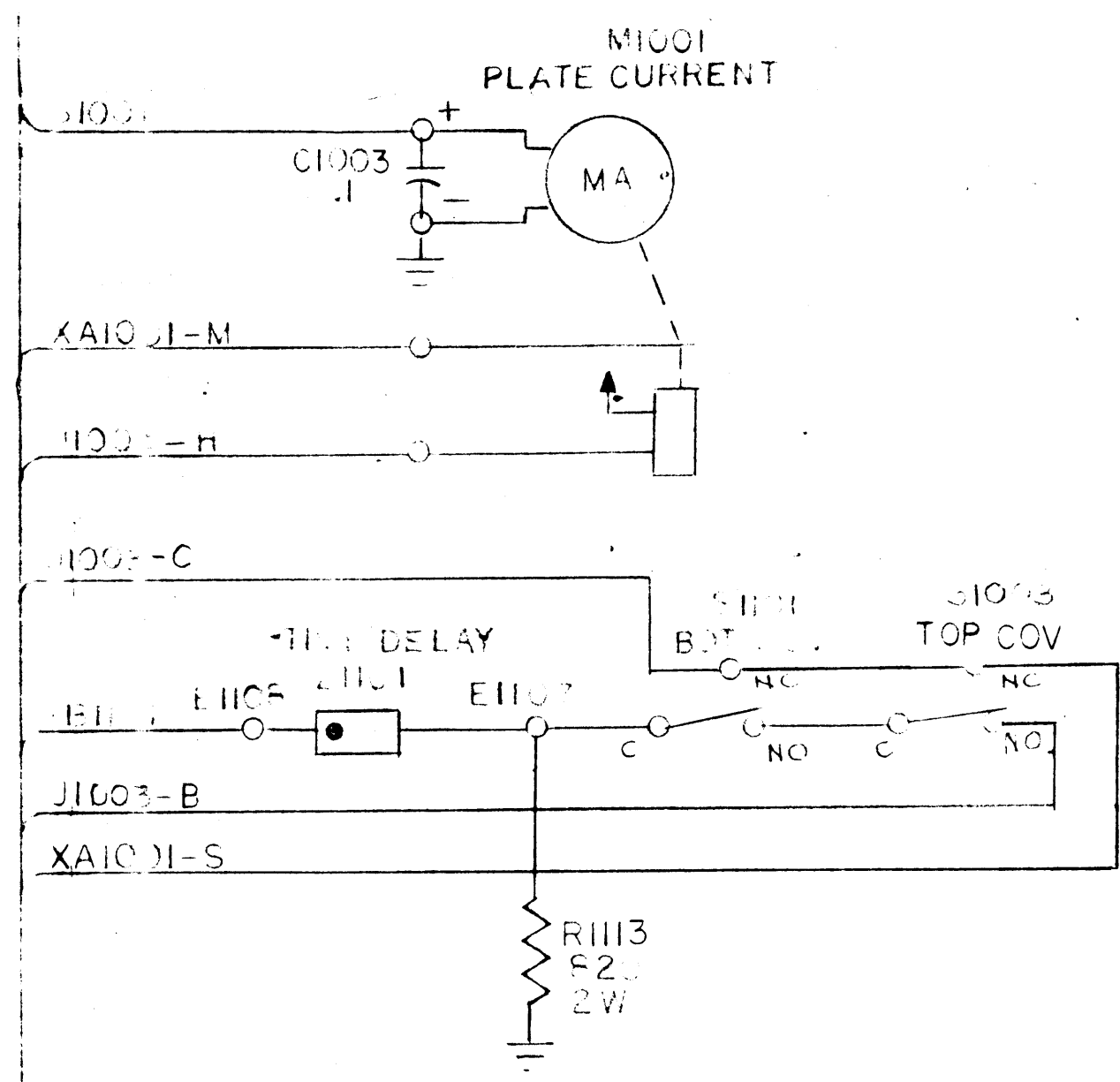
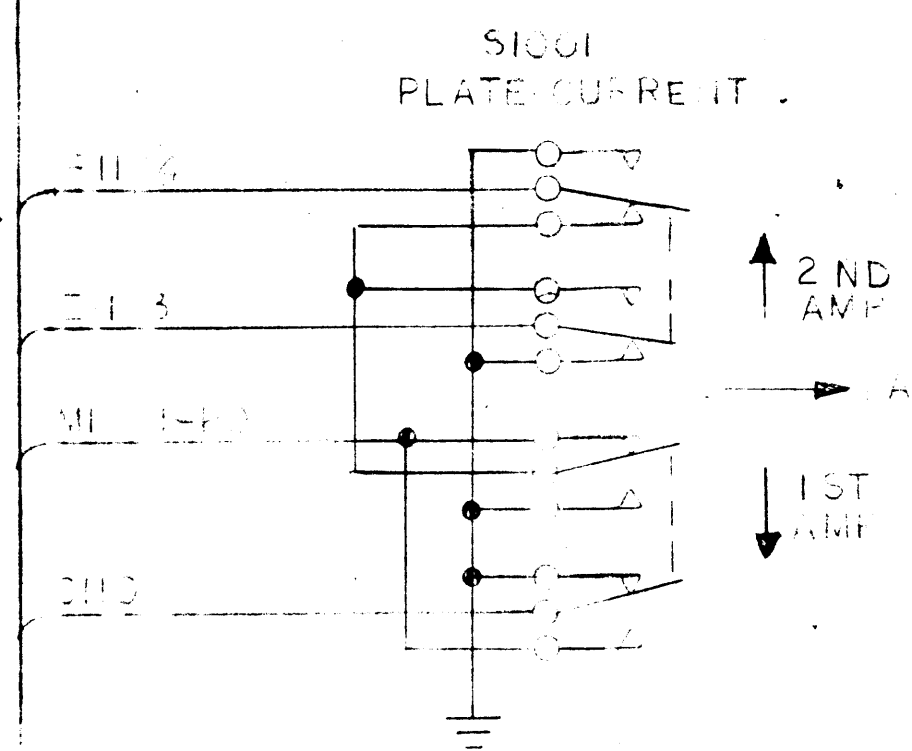
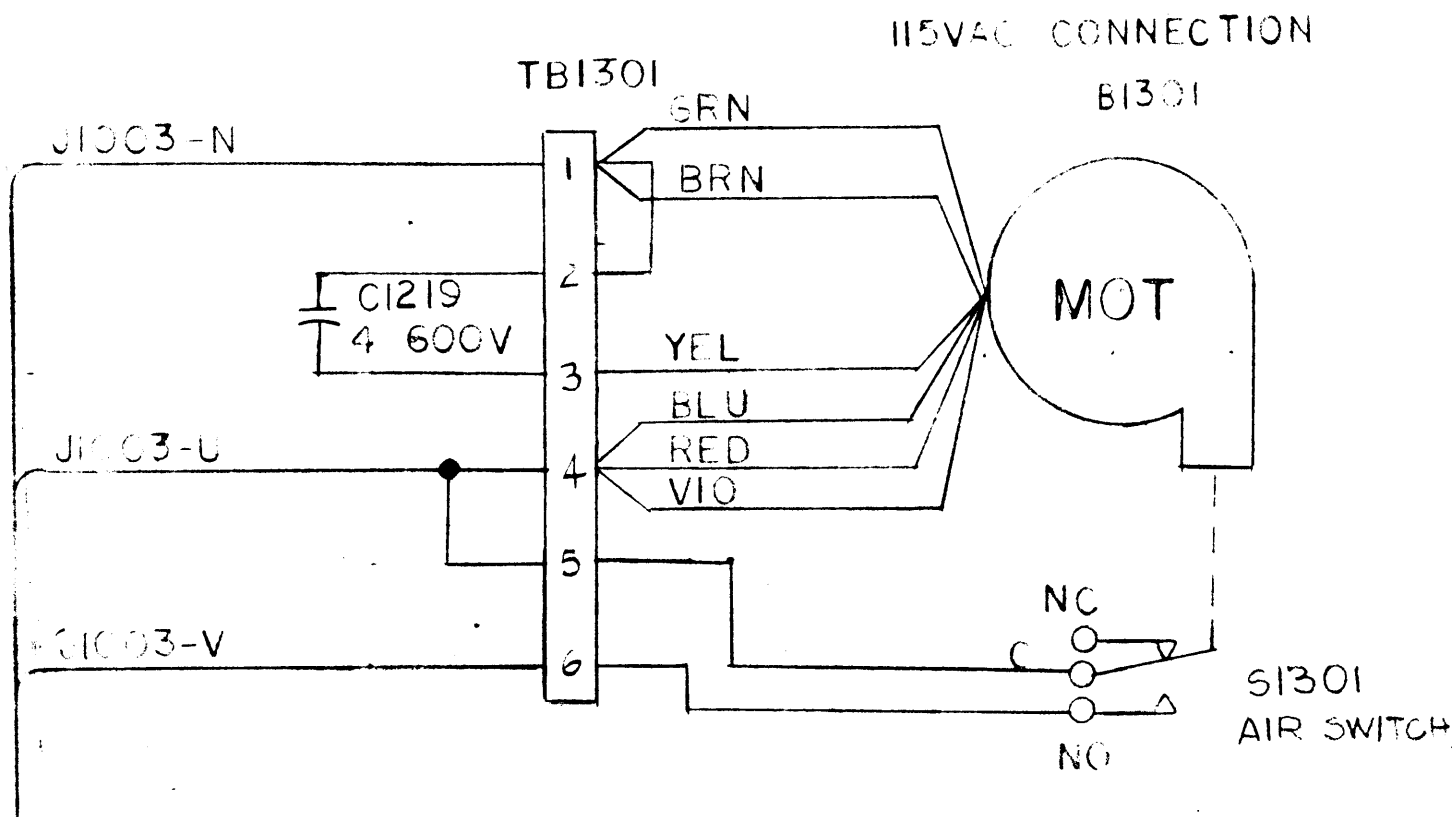

AC CONNECTION

B1301

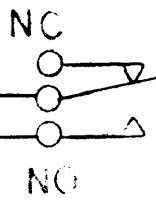
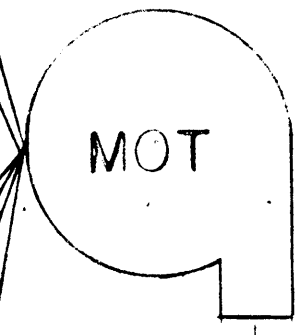

S1301  
AIR SWITCH

230 VAC CONNECTION

TB1301

GRN

B1301

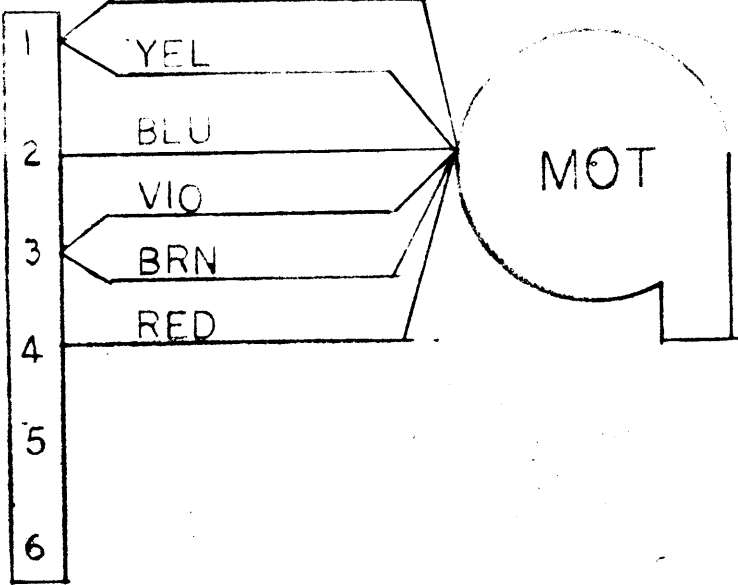

\*\*\* ONE PAIR OF LEADS ONLY IS USED.  
IF TFP-1K IS USED IN SYSTEM, DC1001  
IS REMOVED, UNUSED PAIR IS TIED  
BACK.

K1101  
METER

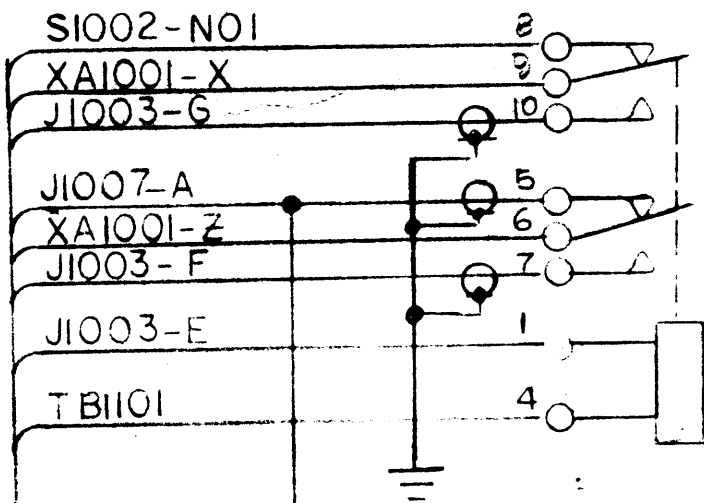

S1002  
REFLECTED

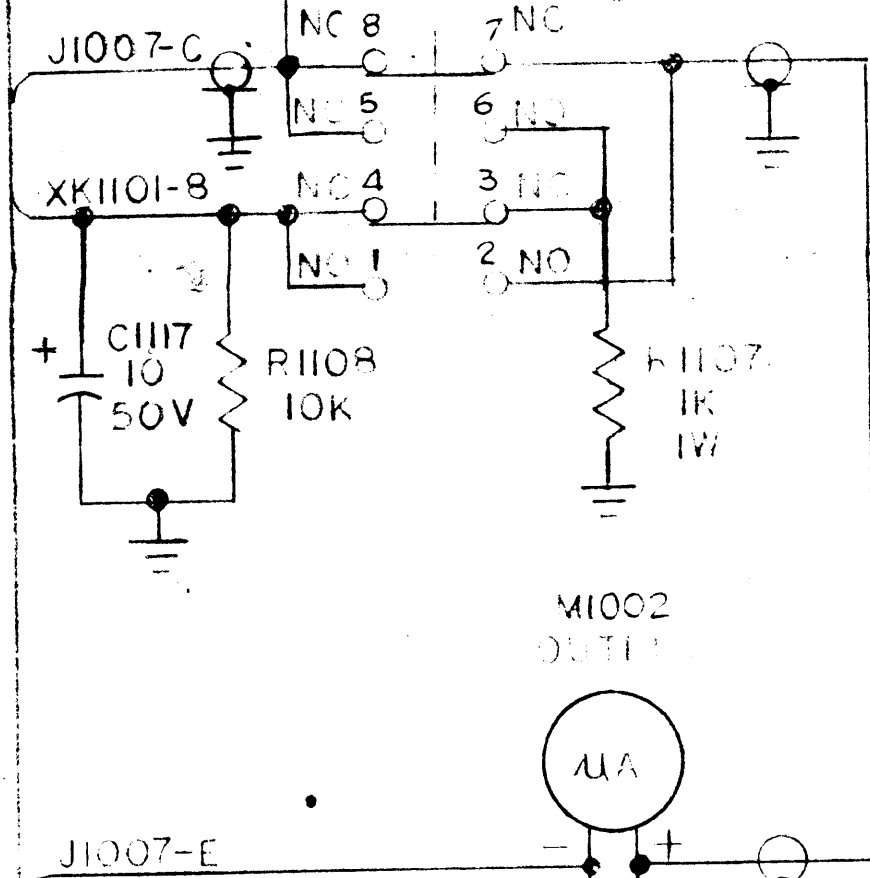

S1003  
TOP COV

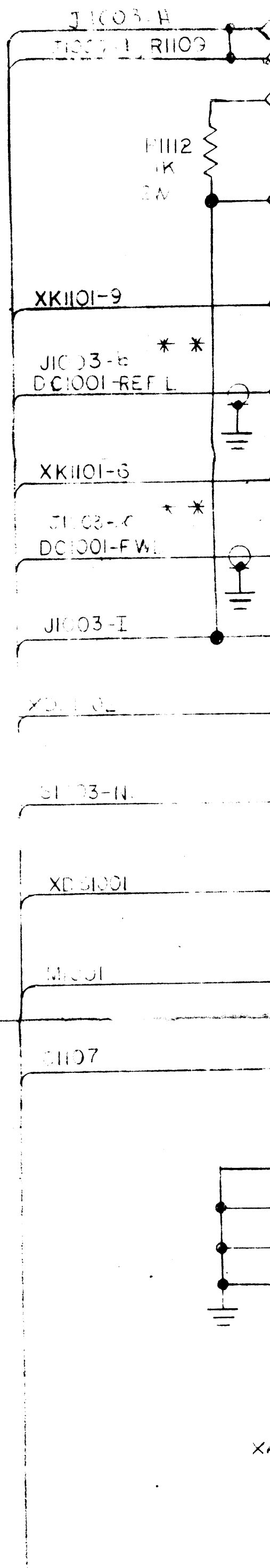
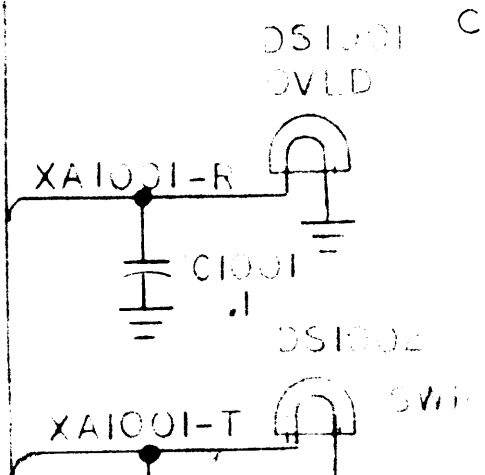
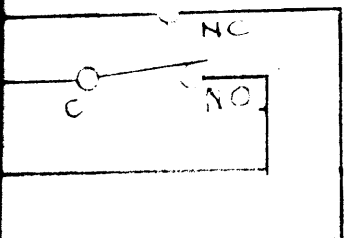

# A1001 OVLD

(A4)

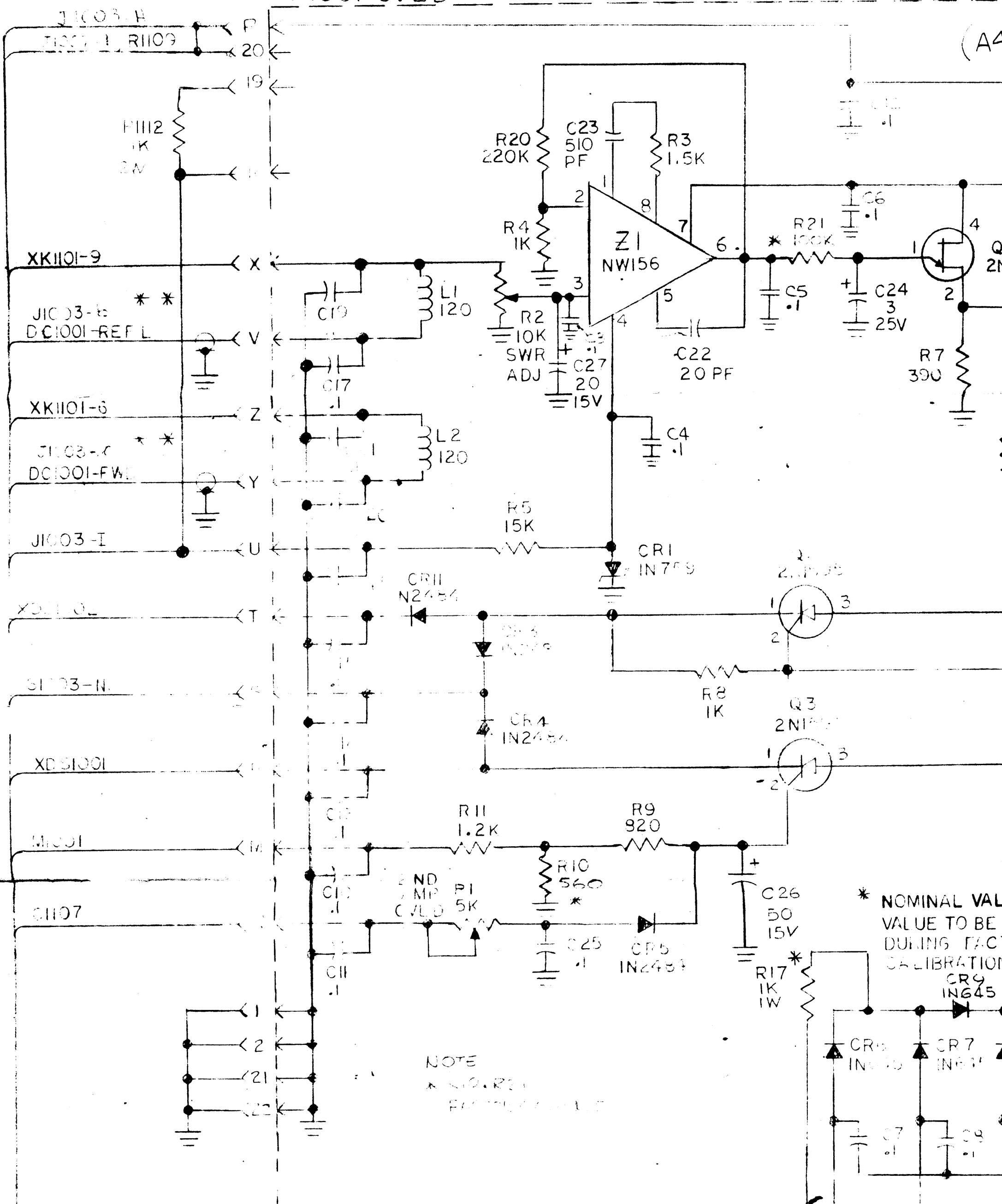

\* NOMINAL VALUE TO BE DURING FACT CALIBRATION  
CR9 IN645

NOTE  
\* NO. R21 FACTORY VALUE

XA1001

A1003 TERM 5

J1003-1

J1003-1

J1003-1

(A4879 / PC600)

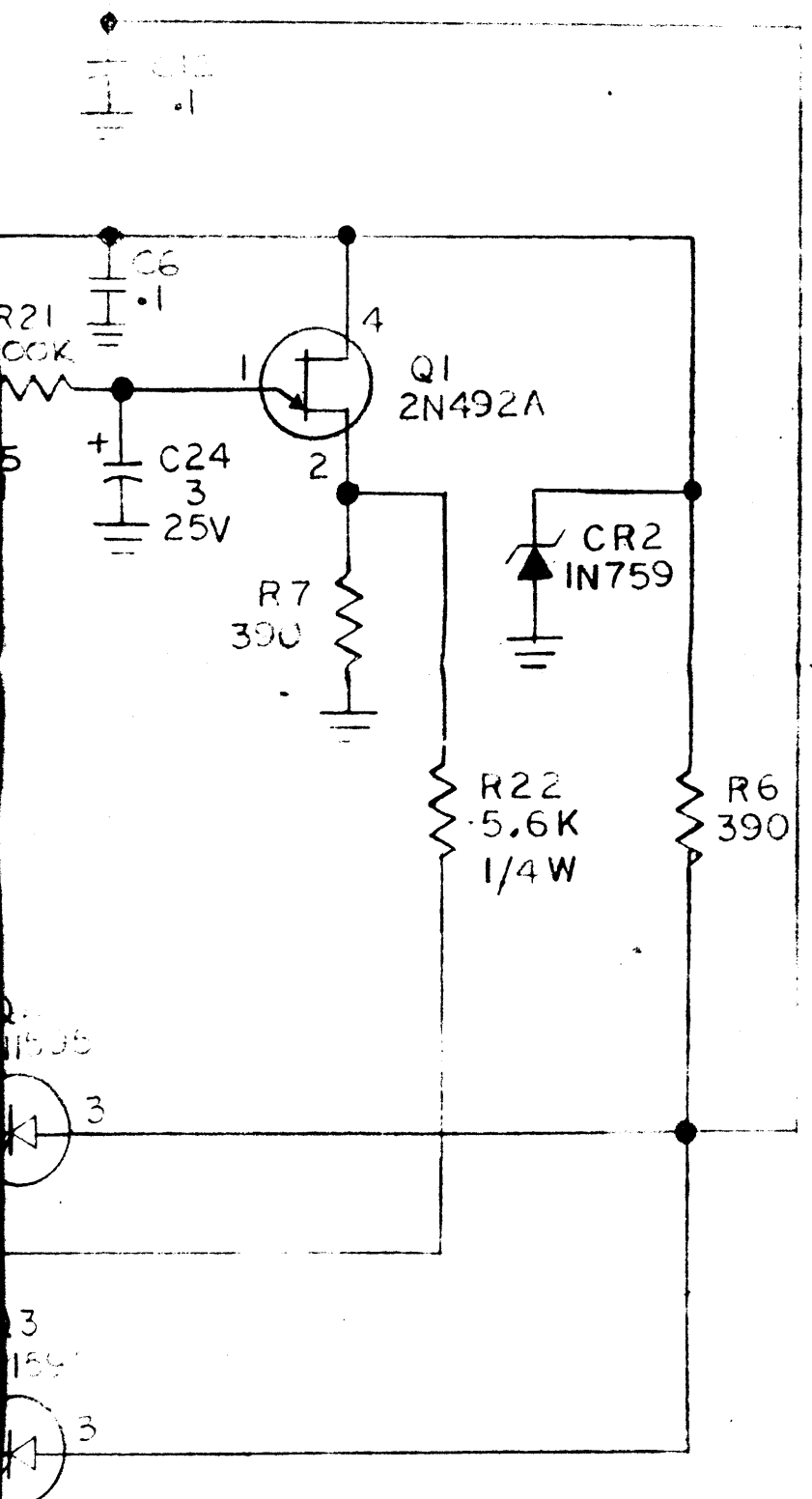

\* NOMINAL VALUE ACTUAL VALUE TO BE SELECTED DURING FACTORY CALIBRATION.

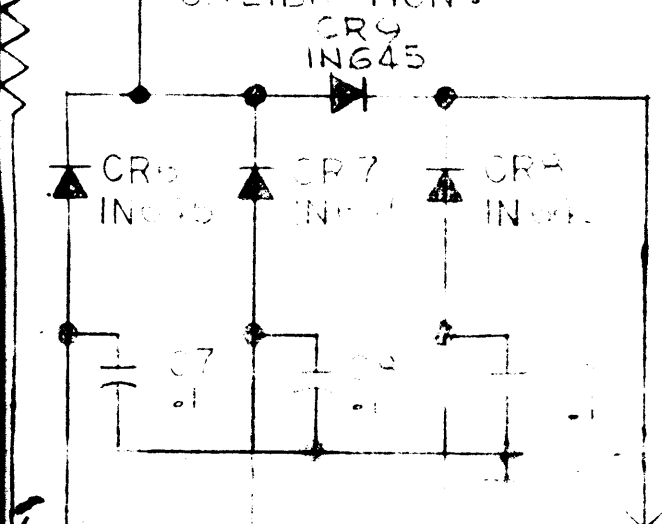

JUN 5-20

JUN 5-15

JUN 5-10

JUN 5-5

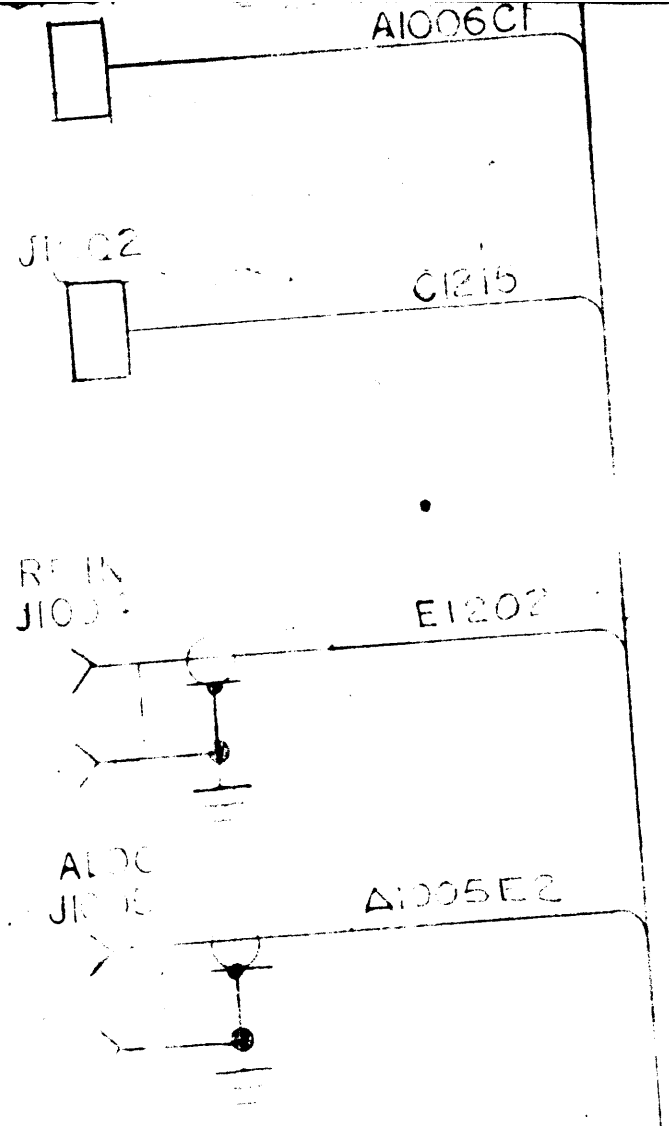

P	
J	XA1002-J, XA1003-J
T	J1008-12
U	A1004-E1
V	A1004-E2
W	A1004-E3
X	A1004-E4
Y	A1004-E5
E	A1004-E6
6	A1004-E7
	A1004-E8
	A1004-E9
	XA1005-G
	R1109

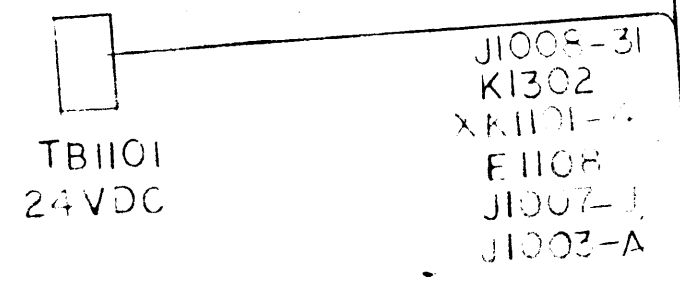

A1000	
LAST	MISSING
A1000	
C100	
D100	
J1002	
L100	
M100	
N100	
XA1003	

A1001	
LAST	MISSING
Q1	
Q11	CR10
L2	
Q3	PE 110
R22	R15-E-N
Z1	

A1002	
LAST	MISSING
A1	
B1	
C1	
S2	

A1003	
LAST	MISSING

A1002-A1, A1003	
LAST	MISSING



- J1008-1
- X A1002-J, X A1003-J
- J1008-12
- A1004-E1
- A1004-E2
- A1004-E3
- A1004-E4
- A1004-E5
- A1004-E6
- A1004-E7
- A1004-E8
- A1004-E9
- X A1005-C
- R1109

TB1101  
 24VDC  
 J1008-31  
 K1302  
 X K1101-4  
 E1108  
 J1007-1  
 J1003-A

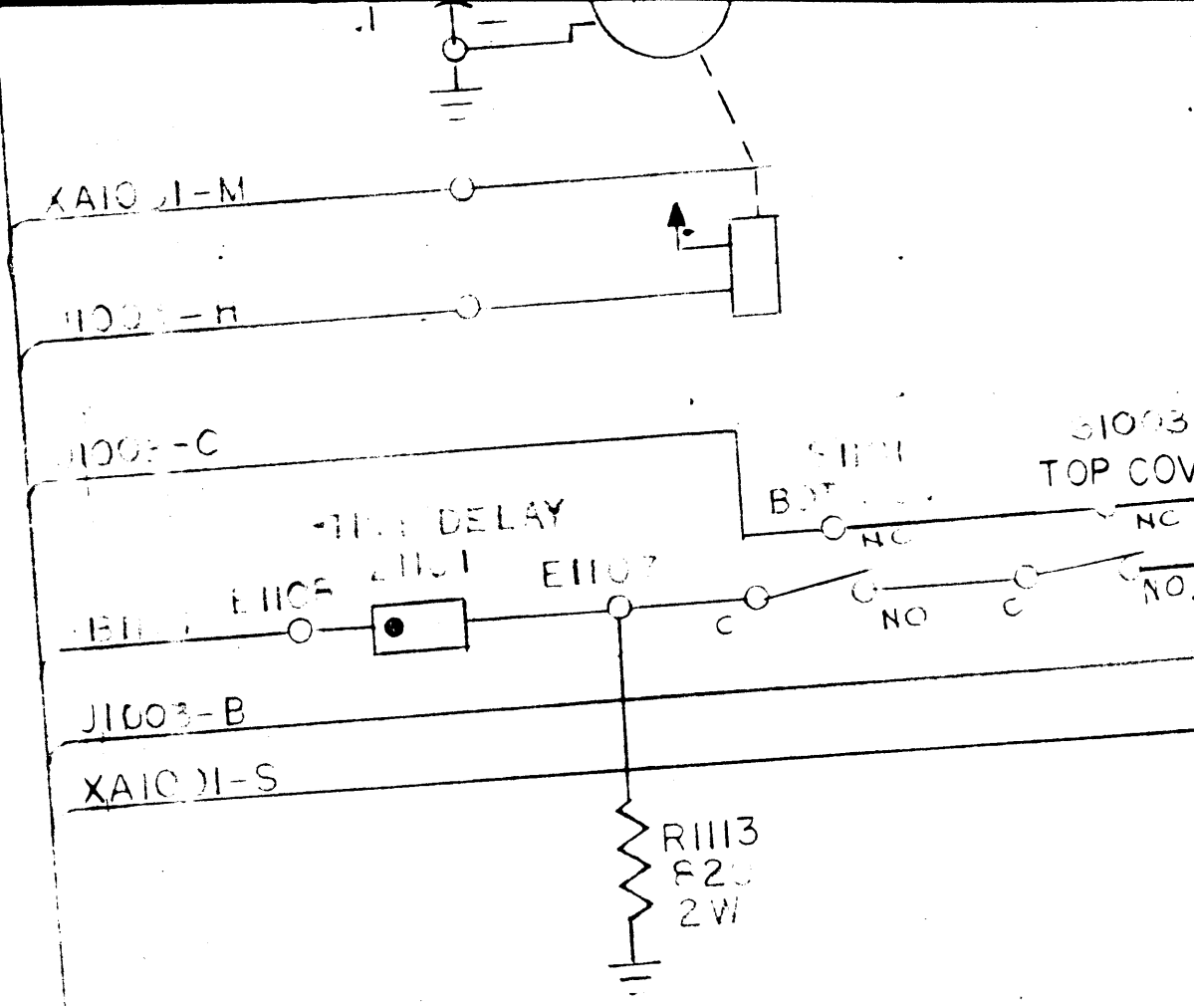

A1003	
LAST	MISSING

A1002 & A1003 A1	
LAST	MISSING

A1004	
LAST	MISSING
J CR3 D33 E10 F1	

A1005	
LAST	MISCINS.
13 CR1 12	

A1006	
LAST	MISSING
CR E2 K1 L3 P1 S2 XK1	

A1400	
LAST	MIS

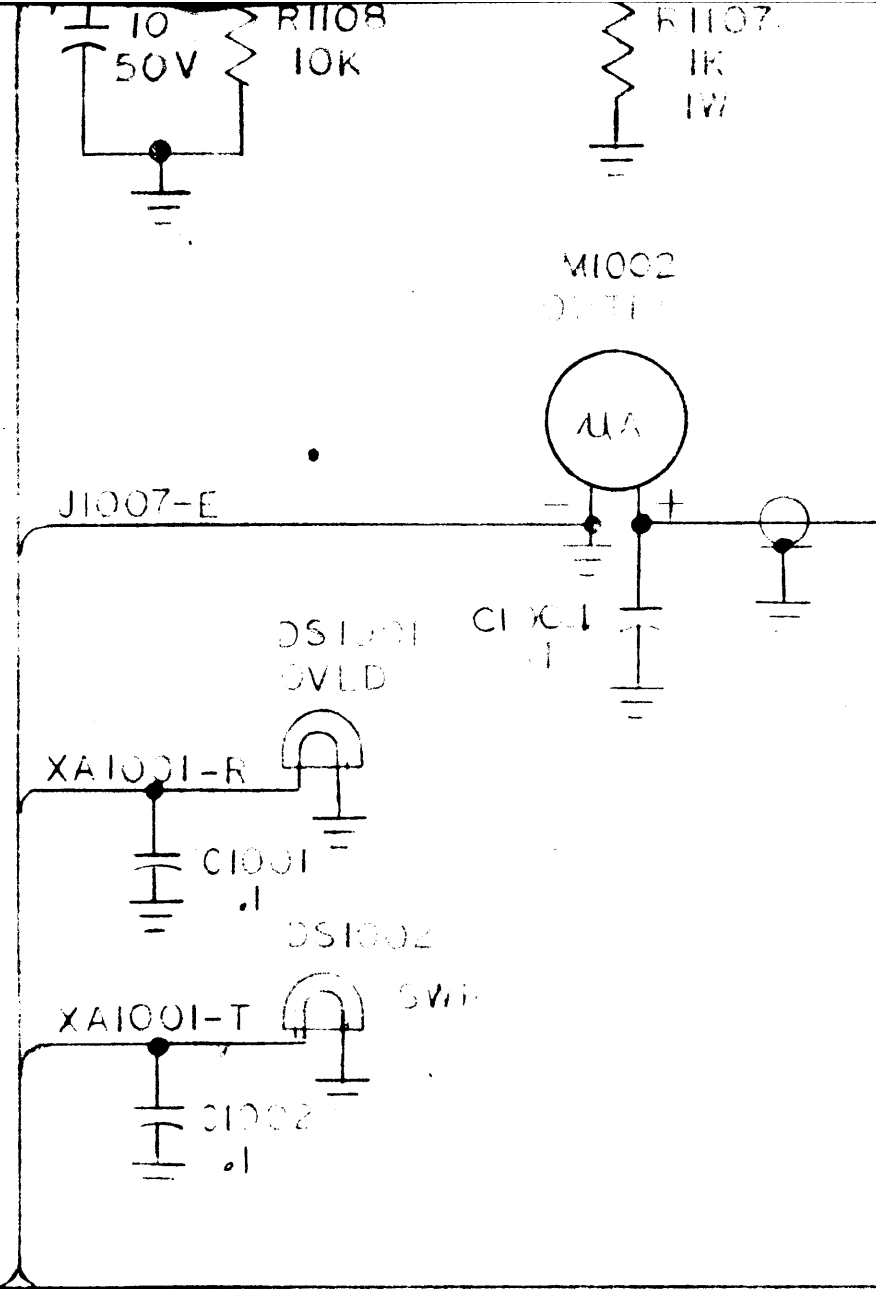
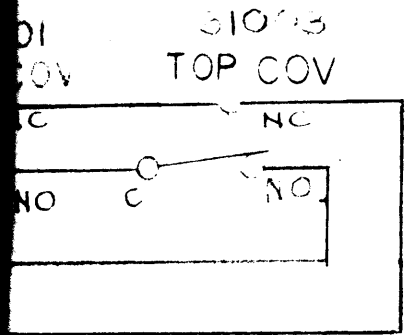

A1400	
LAST	MISSING
C2	

1100	
LAST	MISSING
	C113, H114
F1105	V1102, 1102
K1101	F1101
R1113	S1104
S1101	
TB1101	
XK1101	
Z1101	

1200	
LAST	MISSING
C1220	
F1201	
L1207	L1201
R1214	
T1201	
V1202	
XV1202	
Z1201	

1300	
LAST	MISSING
B1301	C1301, 43.6
C1323	
F1302	
	K1301, K1302
L1307	
R1302	R1301
S1301	
	T1301
TB1301	
VI301	
XVI301	

A1008	
LAST	MISSING

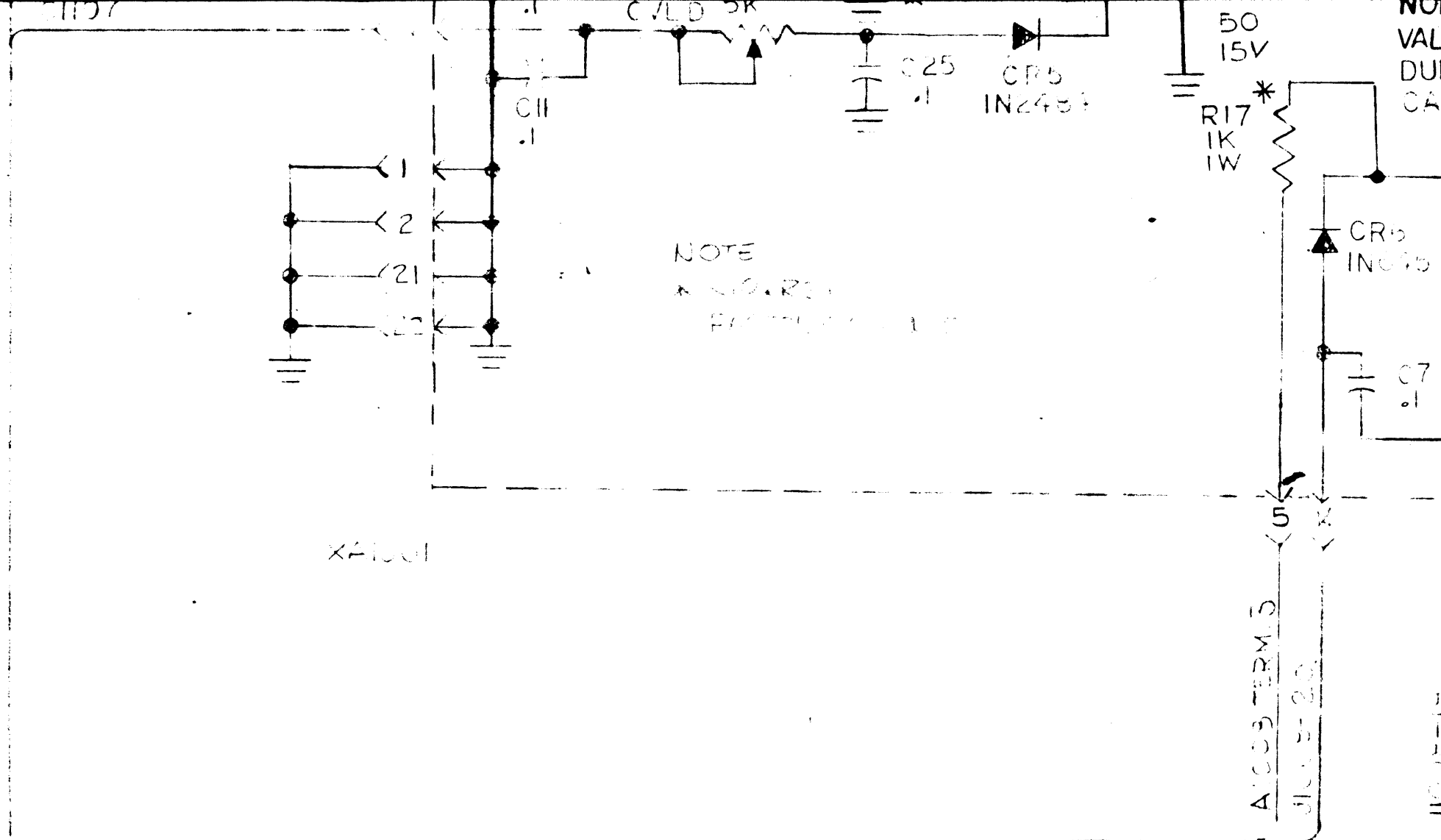

A1008	
LAST	MISSING
5.6	
302	

REVISIONS					
ZONE	LTR	DESCRIPTION	DATE	E.M.N. NO. DRAFT	CHKD. APPR.

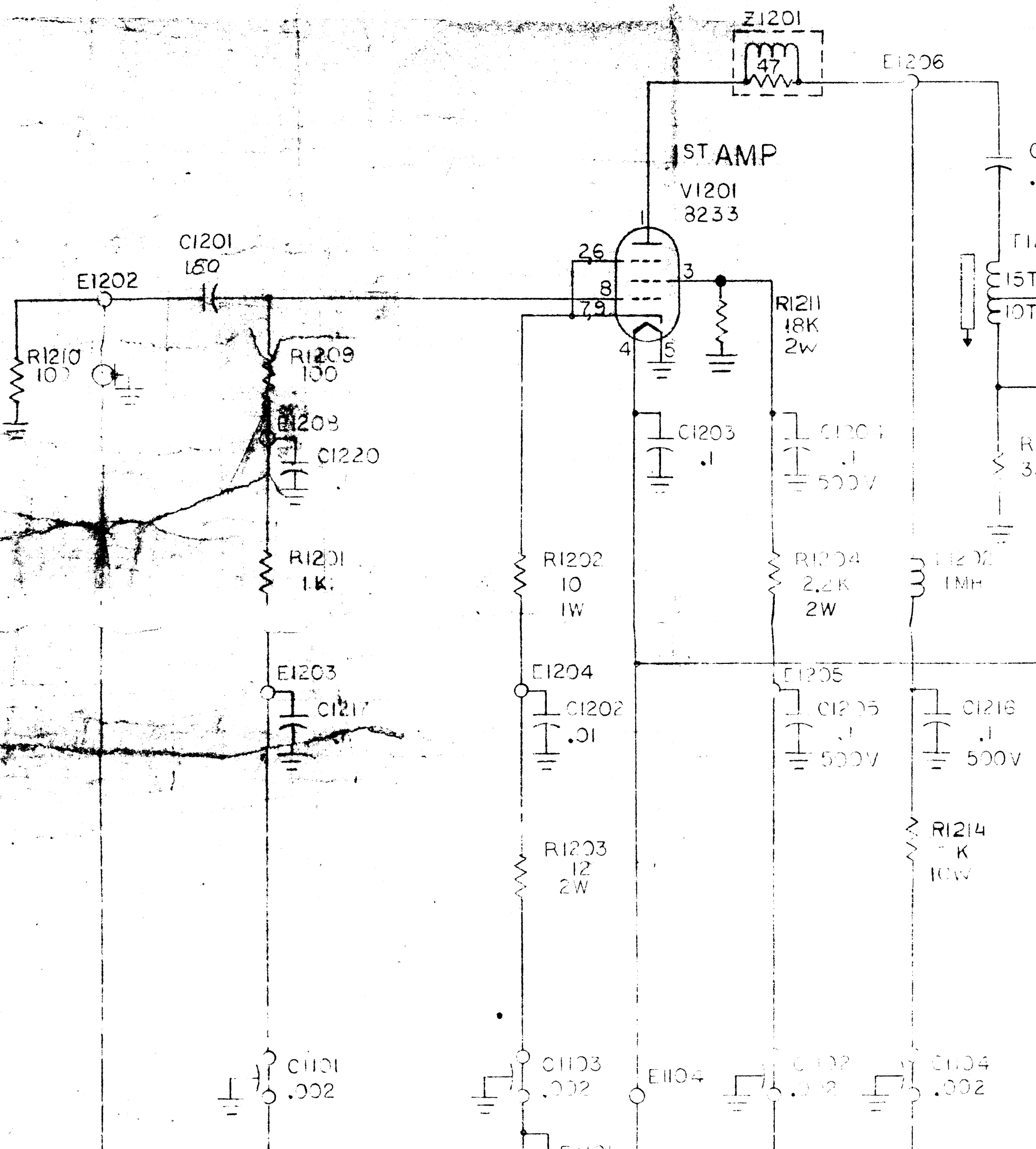

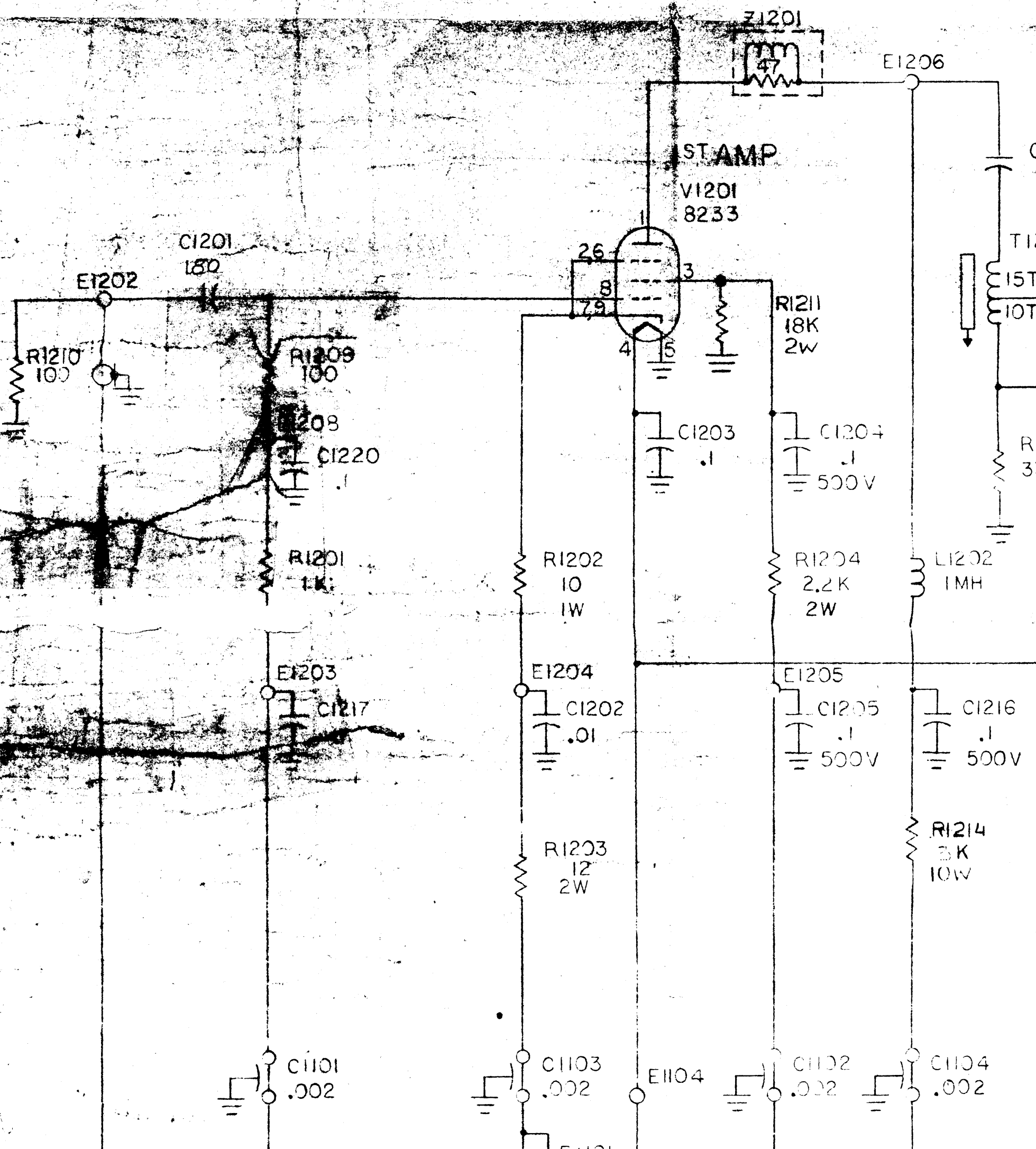

AX787

8-2

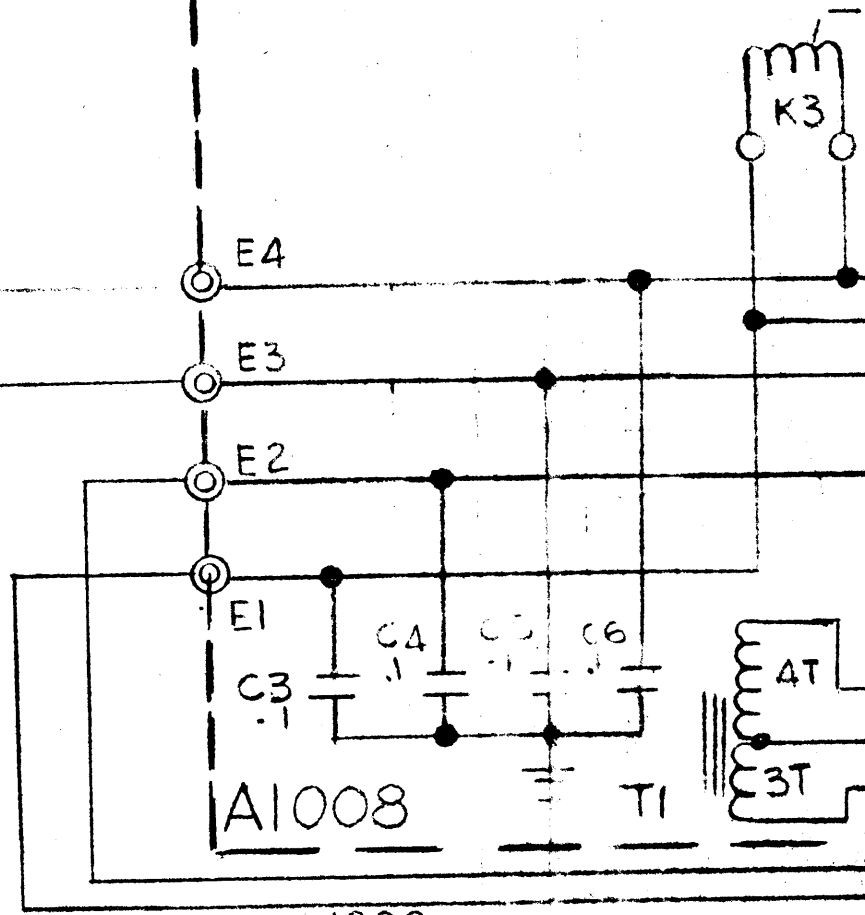

LI206  
4.5  
m

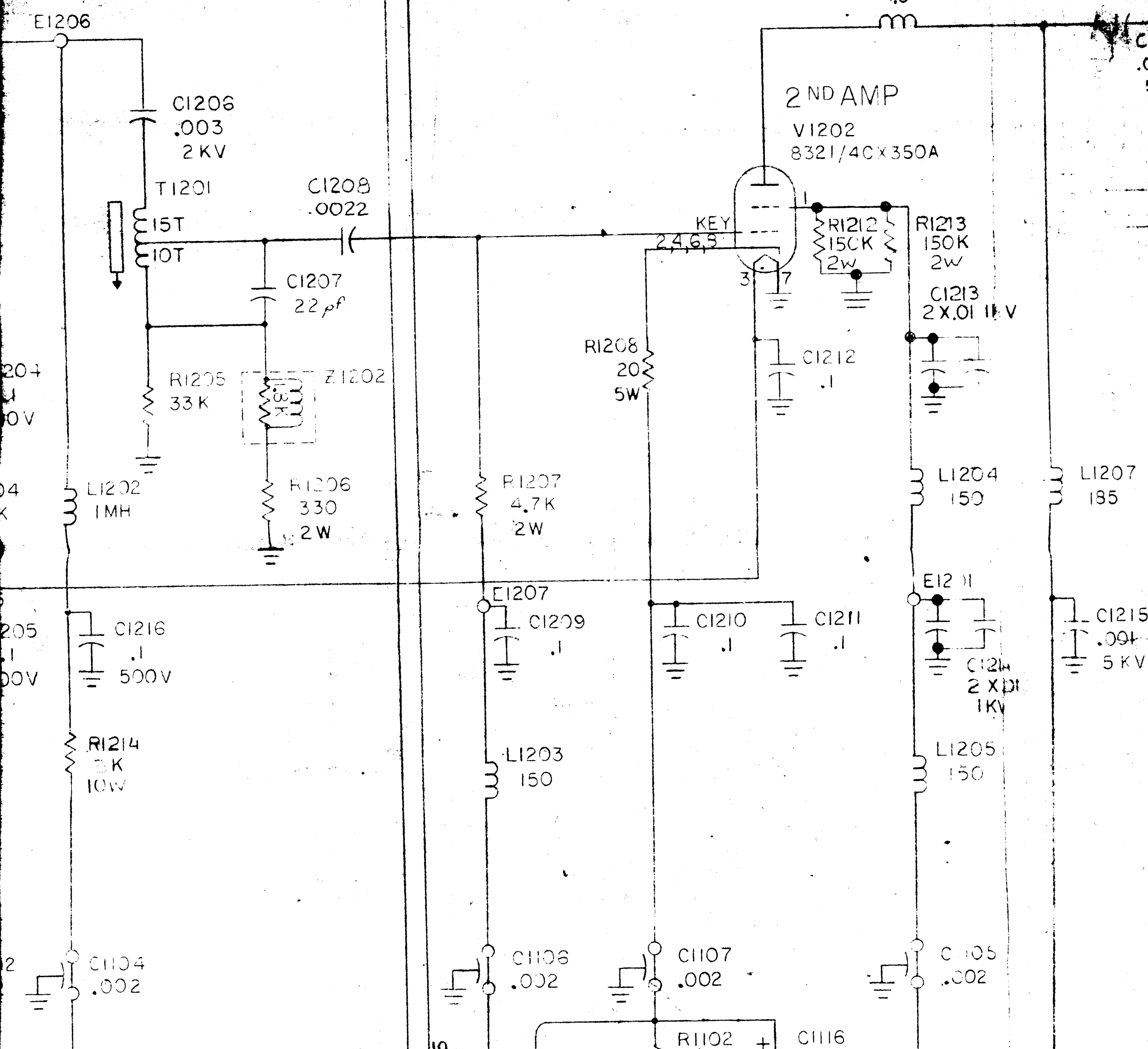



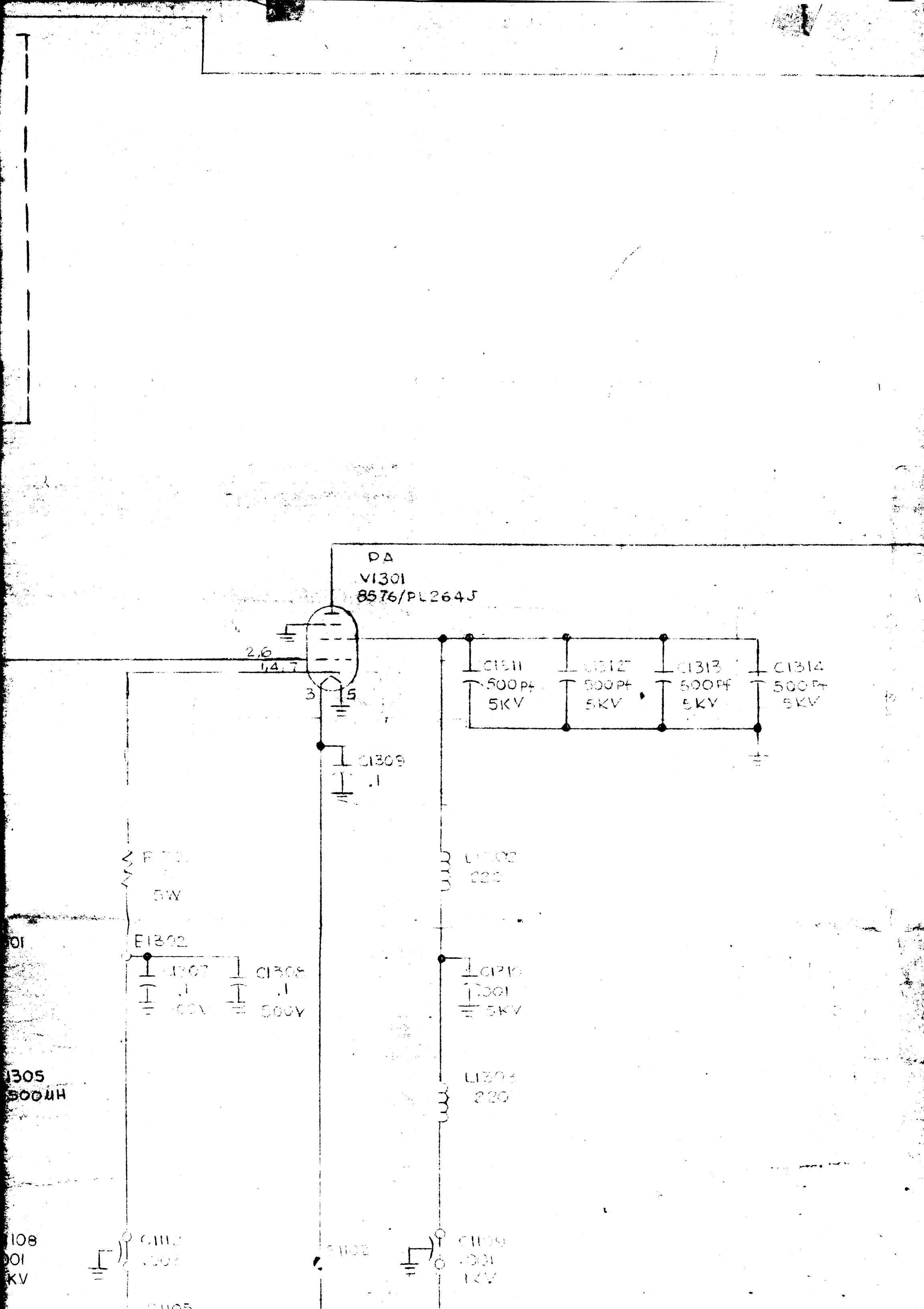

DA  
VI301  
8576/PL264J

2.0  
14.7

3

C1309  
.1

C1311 500PF 5KV  
C1312 500PF 5KV  
C1313 500PF 5KV  
C1314 500PF 5KV

R1301  
5W

E1302

C1307 .1 500V  
C1308 .1 500V

L1301  
220

C1310  
100 5KV

L1302  
220

1305  
500MH

108  
100  
KV

C1102  
200

E1102

C1103  
1KV

C1105



TO  
SH. 3

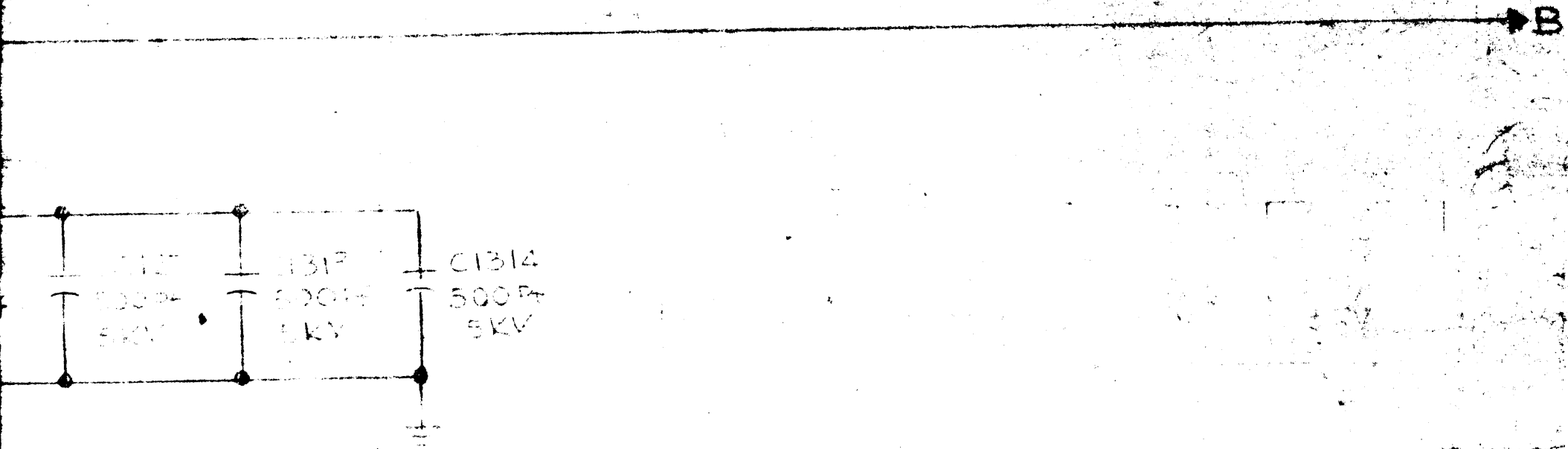

TO  
SH

J1004

J1003-K

S1001

E1102

J1003-Y

J1003-Z

E1203

C1217

E1204

C1202

.01

R1203  
12  
2W

E1205

C1205

.1

500V

C1216

.1

500V

R1214  
5K  
10W

C1101  
.002

C1103  
.002

R1101  
5  
5W

E1104

C1102  
.002

C1104  
.002

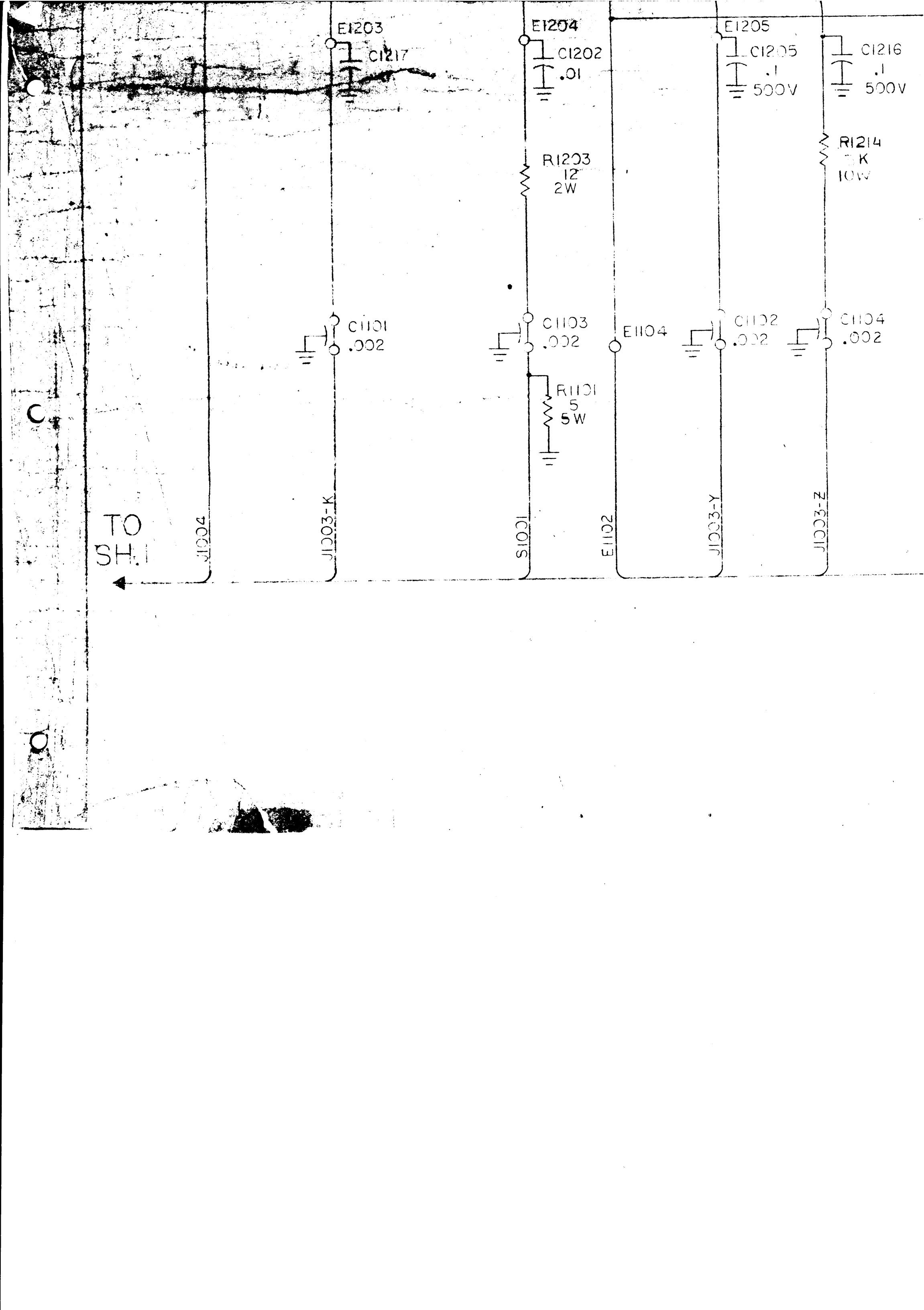

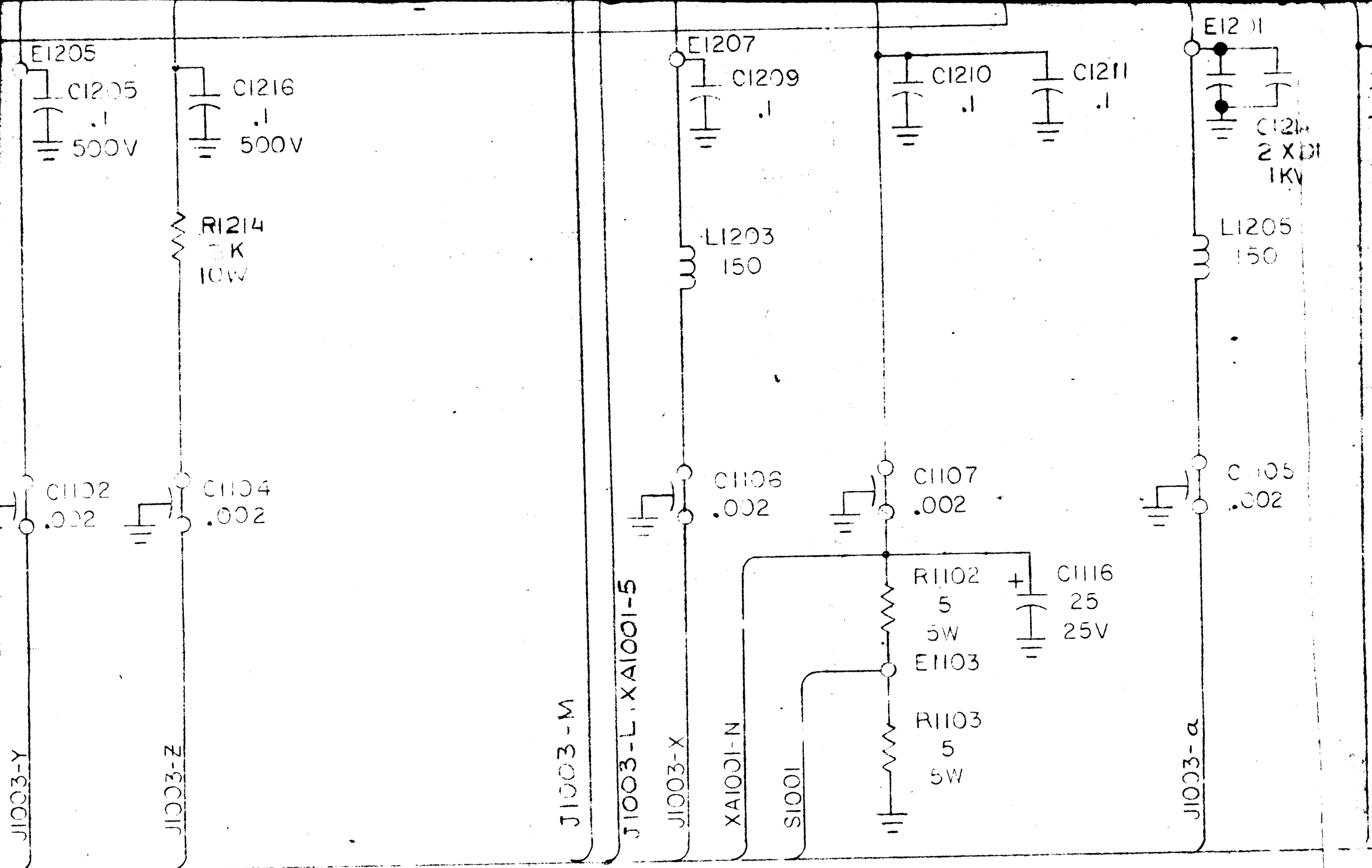

UNLESS OTHERWISE SPECIFIED:

1. ALL RESISTANCES ARE IN OHMS, 1/2 W.
2. ALL INDUCTANCES ARE IN MICROHENRIES.
3. ALL CAPACITANCES ARE IN MICROFARADS.
4. PARTIAL REFERENCE DESIGNATIONS ARE SHOWN. FOR COMPLETE DESIGNATION, PREFIX THE PART DESIGNATION WITH THE SUB-ASSEMBLY DESIGNATION.

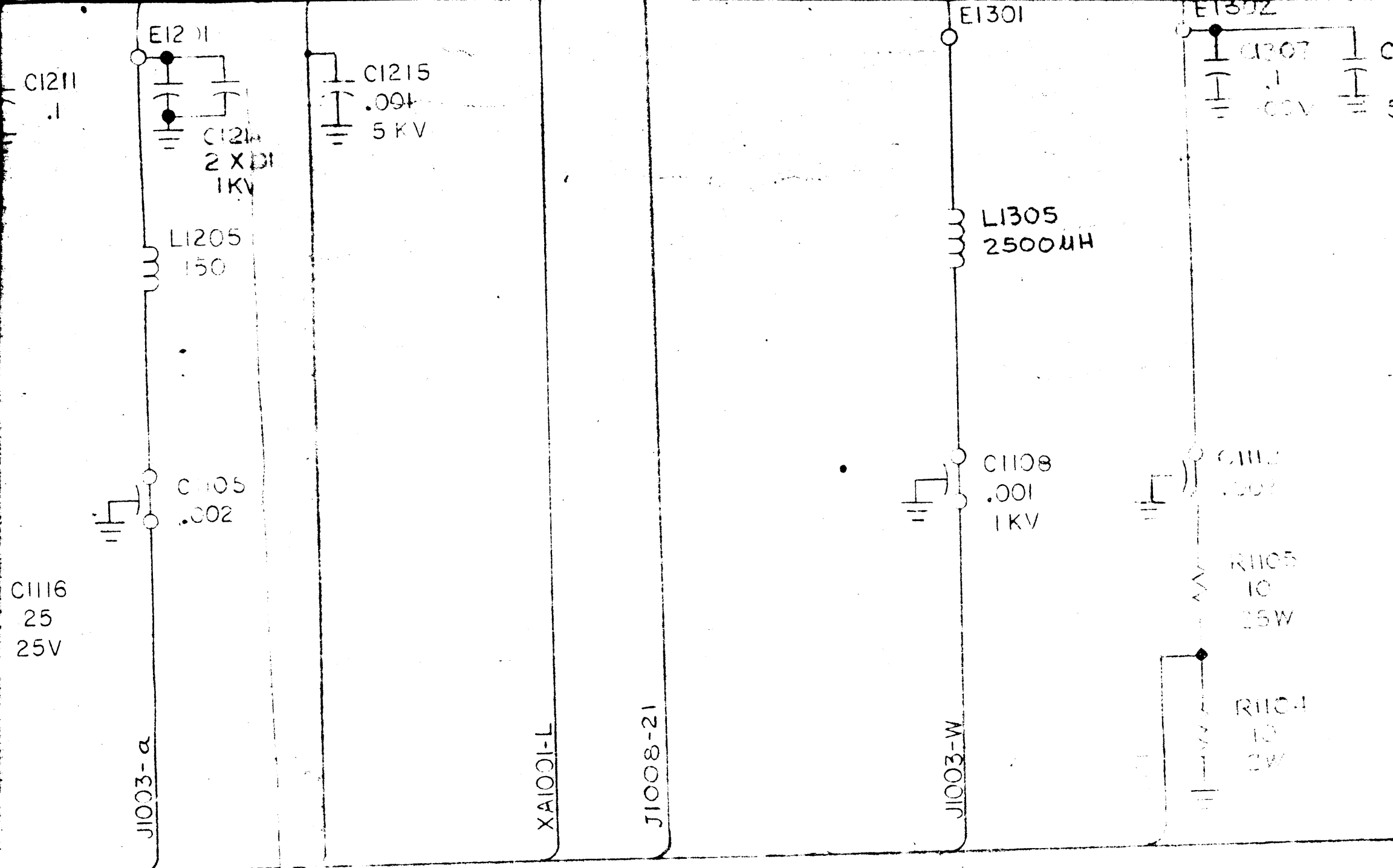

REVISIONS				
ZONE	LTR	DESCRIPTION	DATE	E.M.N.O.

TIX

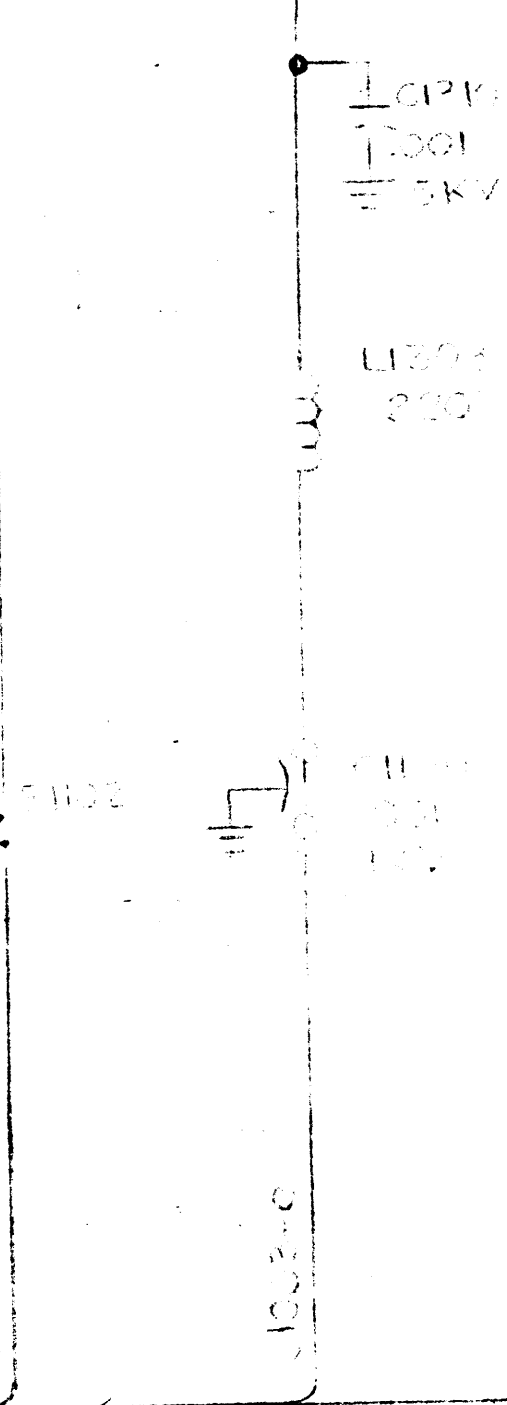
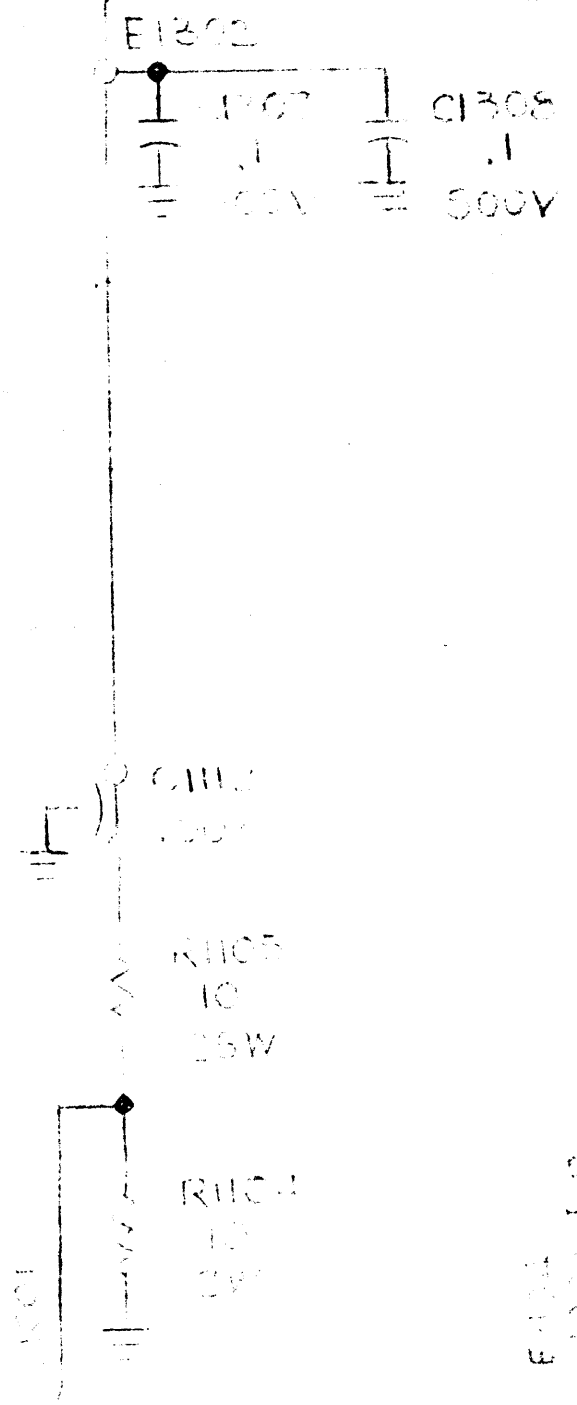

REVISIONS					
DATE	E.M.N.NO	DRAET	CHKD	APPD	

**NOTICE TO PERSONS RECEIVING THIS DRAWING**

THE TECHNICAL MATERIEL CORPORATION claims proprietary right in the material disclosed hereon. This drawing is issued in confidence for engineering information only and may not be reproduced or used to manufacture anything shown hereon without permission from THE TECHNICAL MATERIEL CORPORATION to the user. This drawing is loaned for mutual assistance and is subject to recall at any time.

QTY	MODEL USED ON	ASSY

FINAL APPROVAL		DATE
MECH. DES.		DATE
ELECT. DES.		DATE
CHECKED		DATE
DRAWN	G.D.L.	7-18-70

TO  
SH.3

RECEIVING THIS DRAWING  
claims proprietary right in the material disclosed hereon  
ing information only and may not be reproduced or used  
permission from THE TECHNICAL MATERIEL CORPORATION  
assistance and is subject to recall at any time.

ON	ASSY
A/T	

FINAL APPROVAL	DATE
MECH. DES.	DATE
ELECT. DES.	DATE
CHECKED	DATE
DRAWN G.D.L.	DATE 7-18-76

Figure 7-3

TLAM-1KA  
SCHEMATIC DIAGRAM

Sheet - 2 of 3

CK2221-0

0  
4.2

# A1006 BANDSWITCH

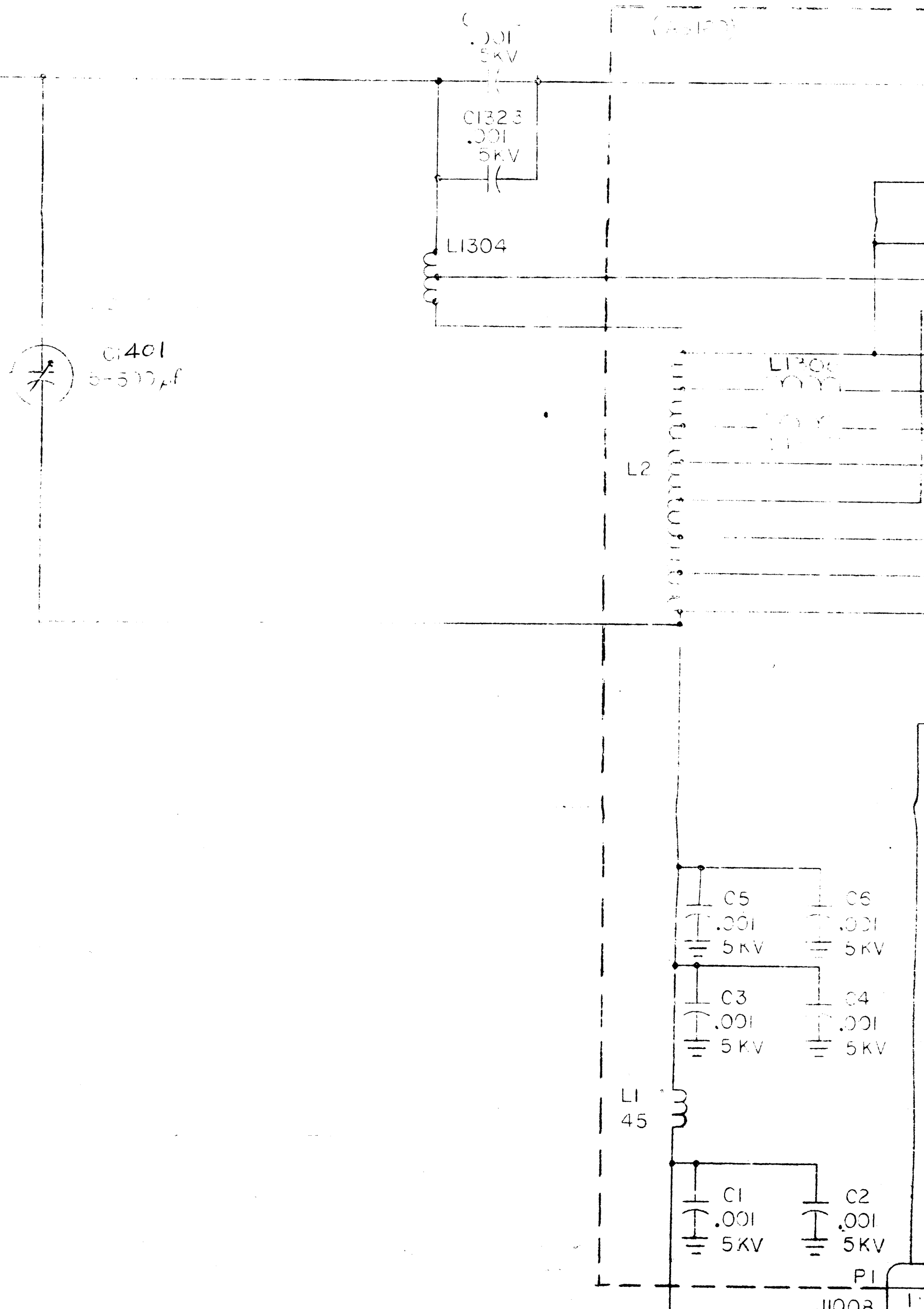

006 BANDSWITCH

(SIF)

L3

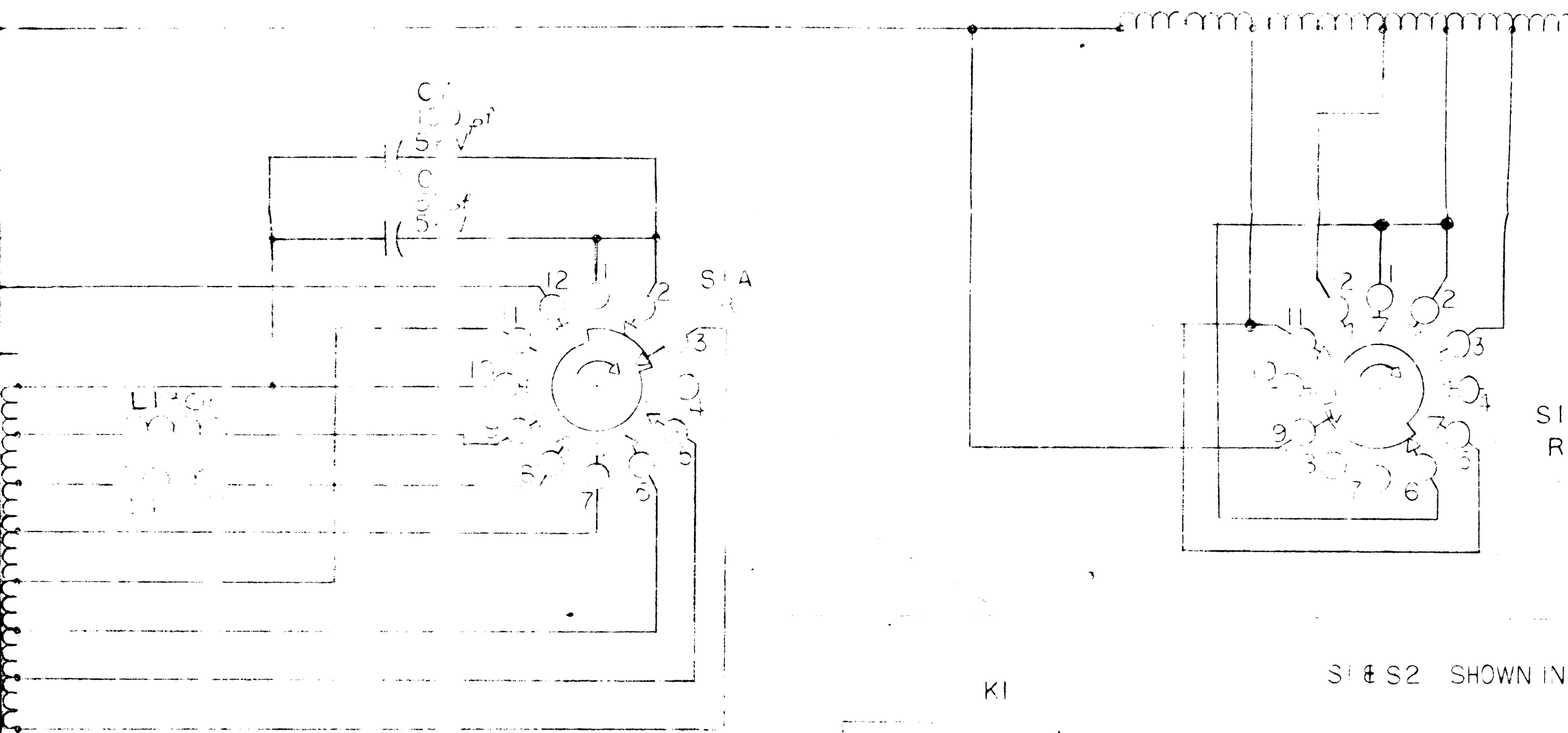

K1

S1 & S2 SHOWN IN

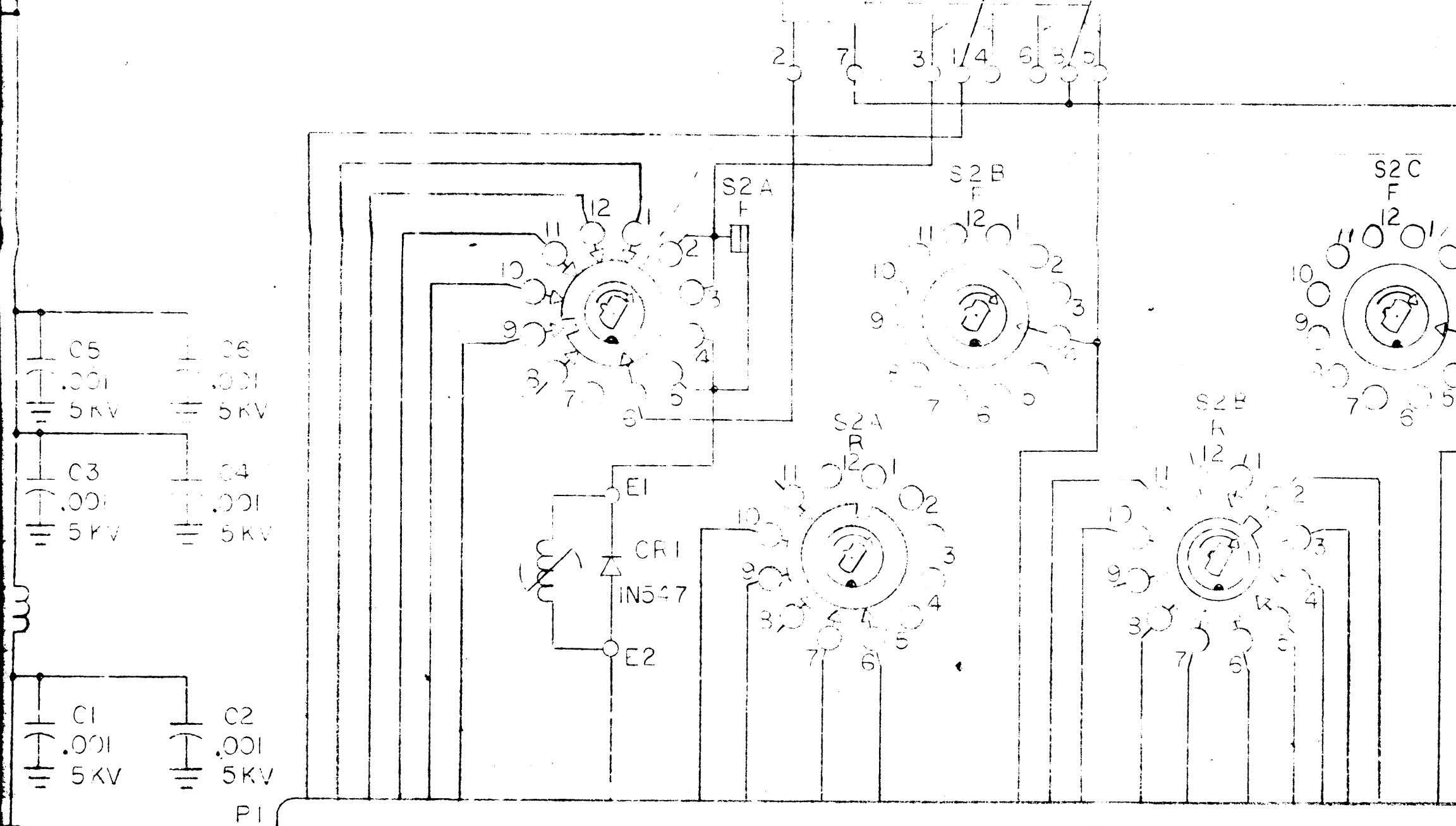

- C5 .001 5KV
- C3 .001 5KV
- C1 .001 5KV
- C6 .001 5KV
- C4 .001 5KV
- C2 .001 5KV

PI  
J1003 1 6 5 4 3 2 11 10 9 8 7 12 21 20 19 18 17 15 14 13 22



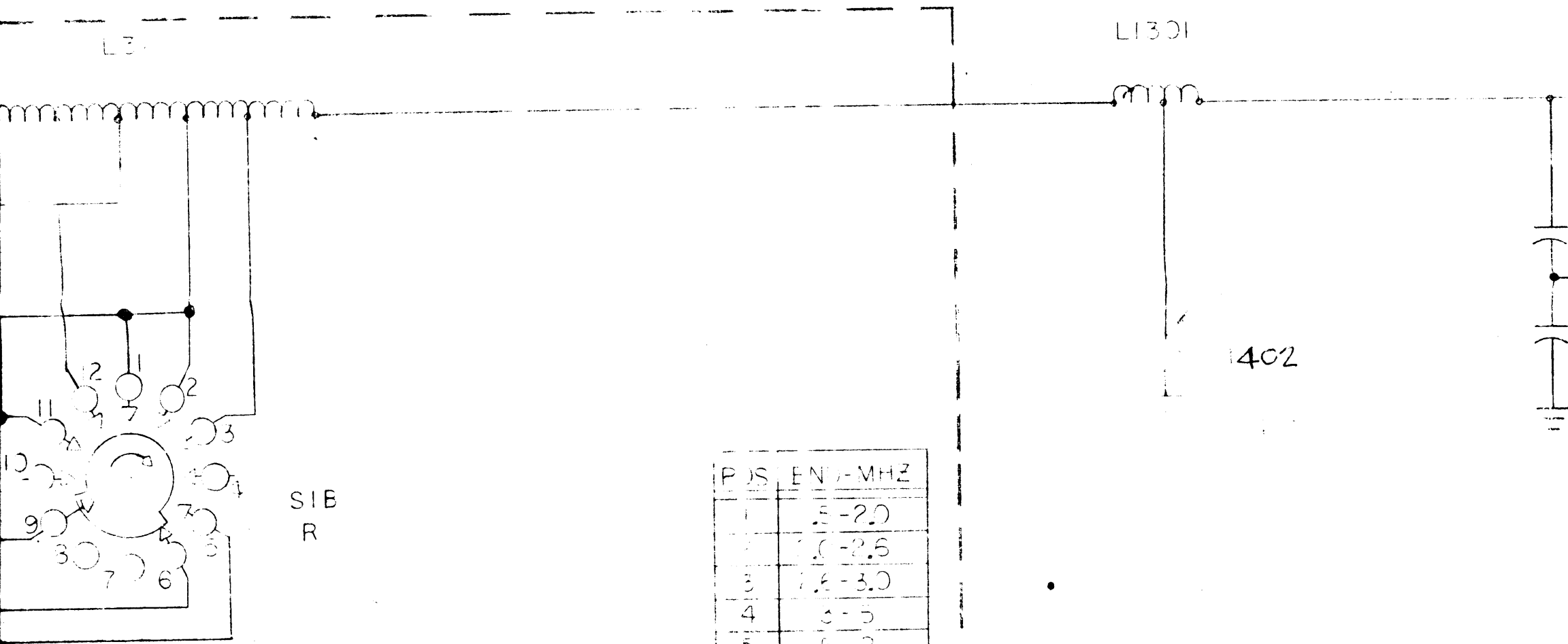

POS	END-MHZ
1	5-2.0
2	2.0-2.5
3	2.5-3.0
4	3-5
5	5-8
6	8-12
7	12-16
8	*
9	16-24
10	24-30
11	*
12	*

S1 & S2 SHOWN IN POSITION 1, BAND 1.

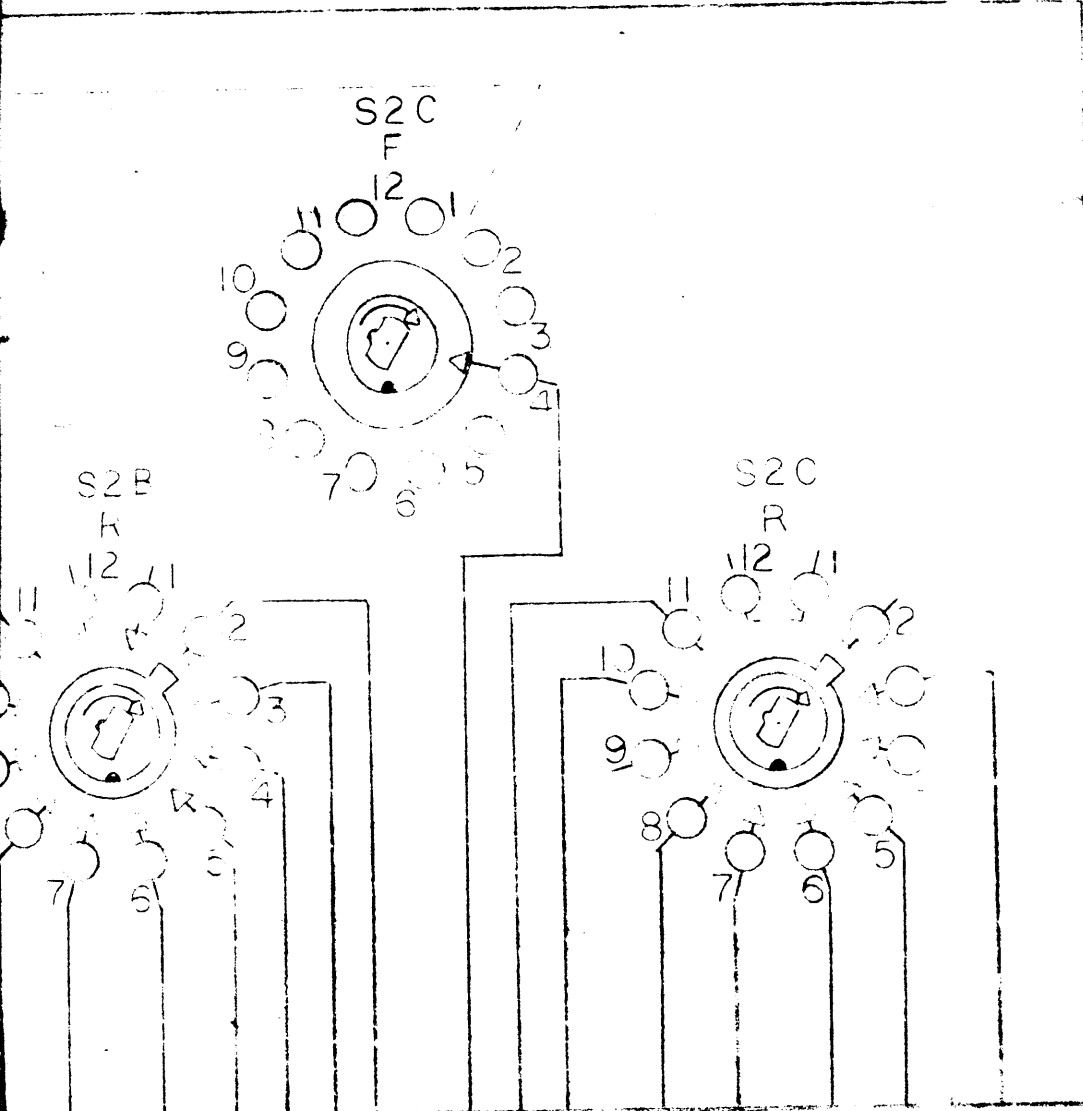

19 18 17 16 15 14 13 22 23 24 25 26 27 28 930 31

A1005, C1005, C1006, 301  
IF THERE IS NO TRF-1K

L1301

402

DC100

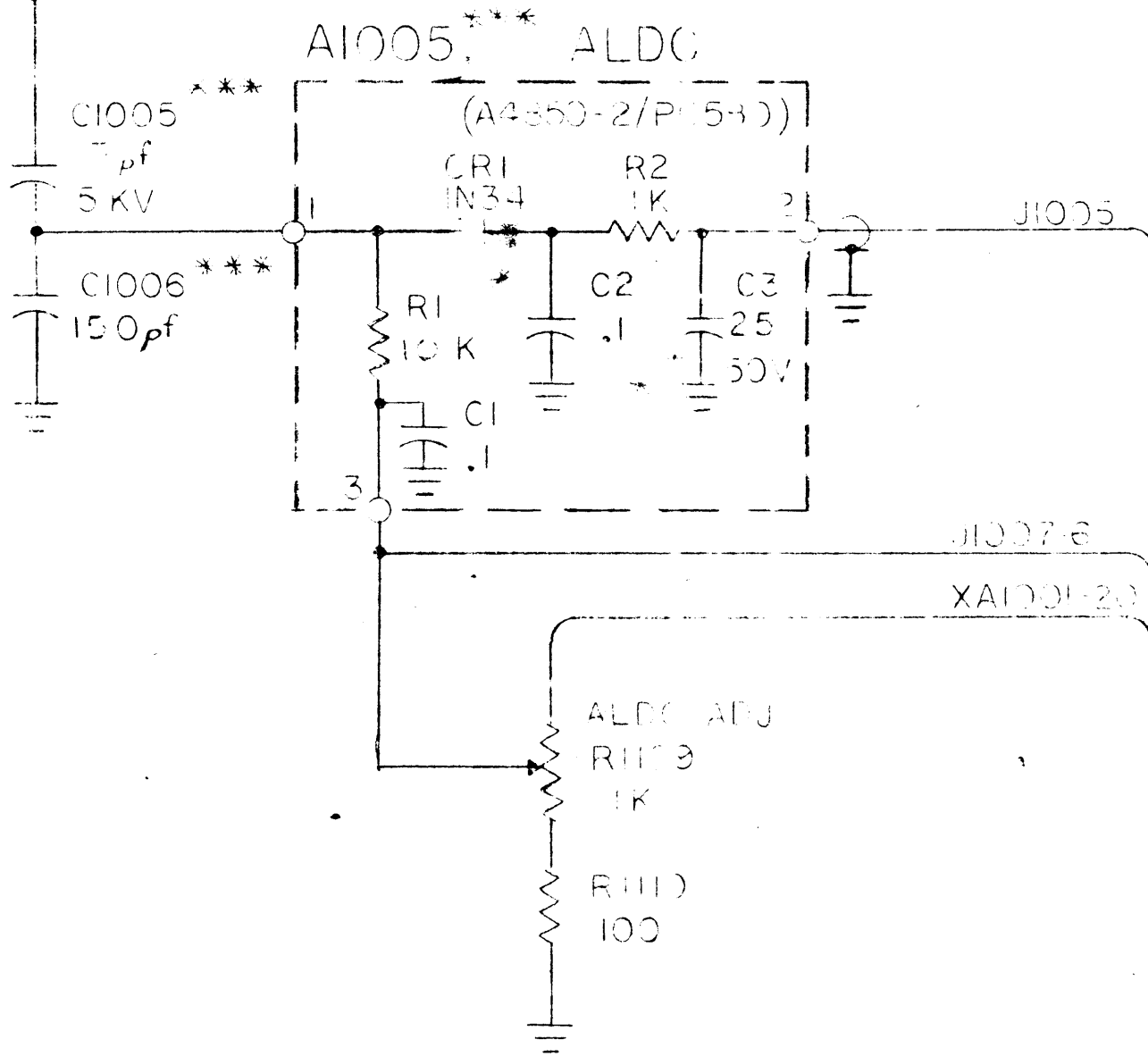

J1008-21, J1007

J1008-20, J1007

J1008-19, J1007

J1008-18, J1007

J1008-17, J1007

J1008-16, J1007

J1008-15, J1007

AI005, CI005, CI004, and AI004 ARE MOUNTED IN THE PANEL IF THERE IS NO TFR-1K USED IN THE SYSTEM.

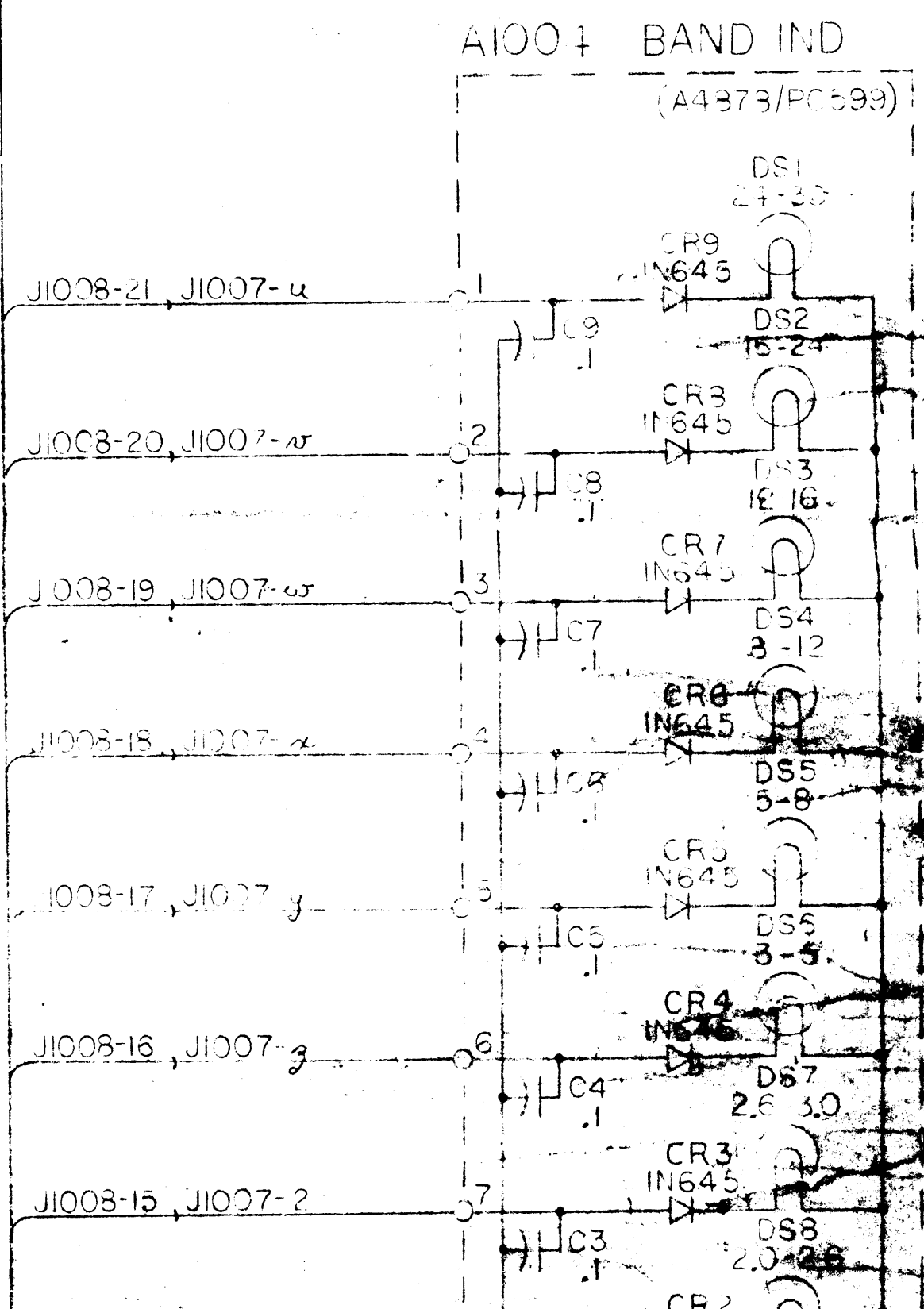
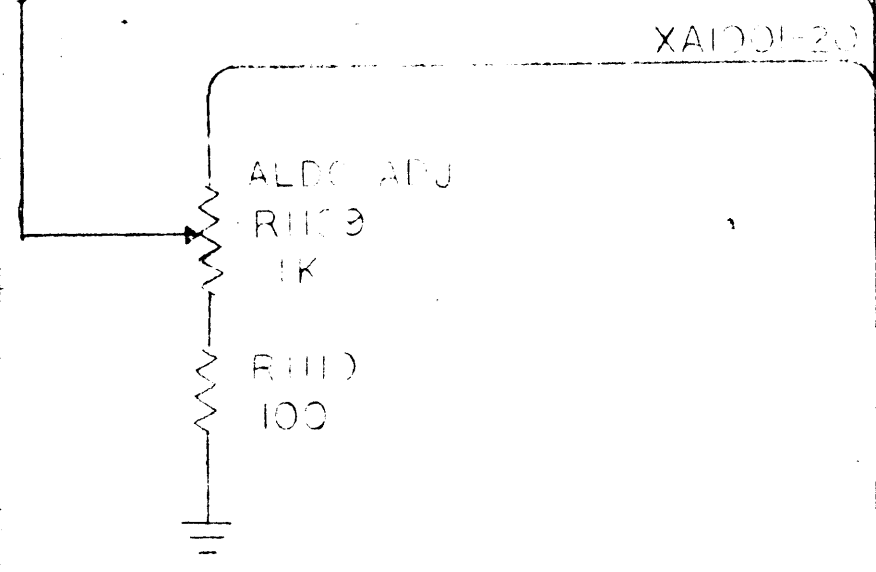
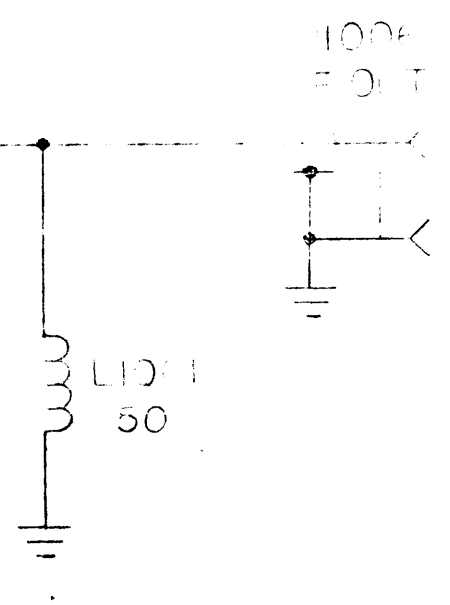
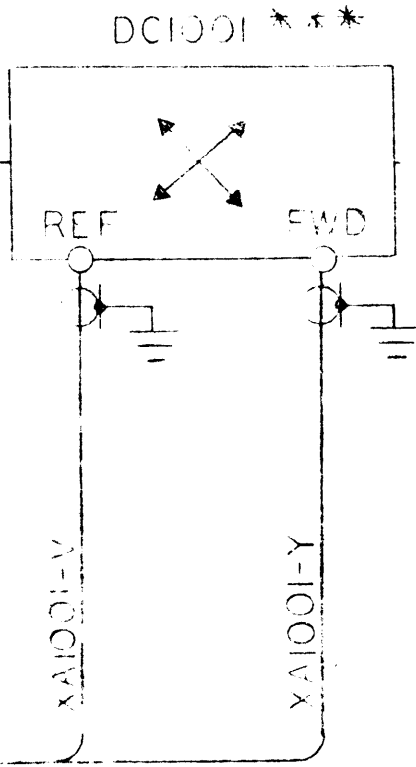
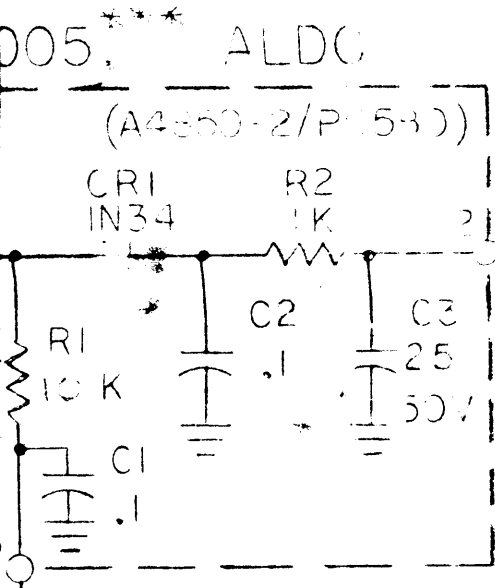

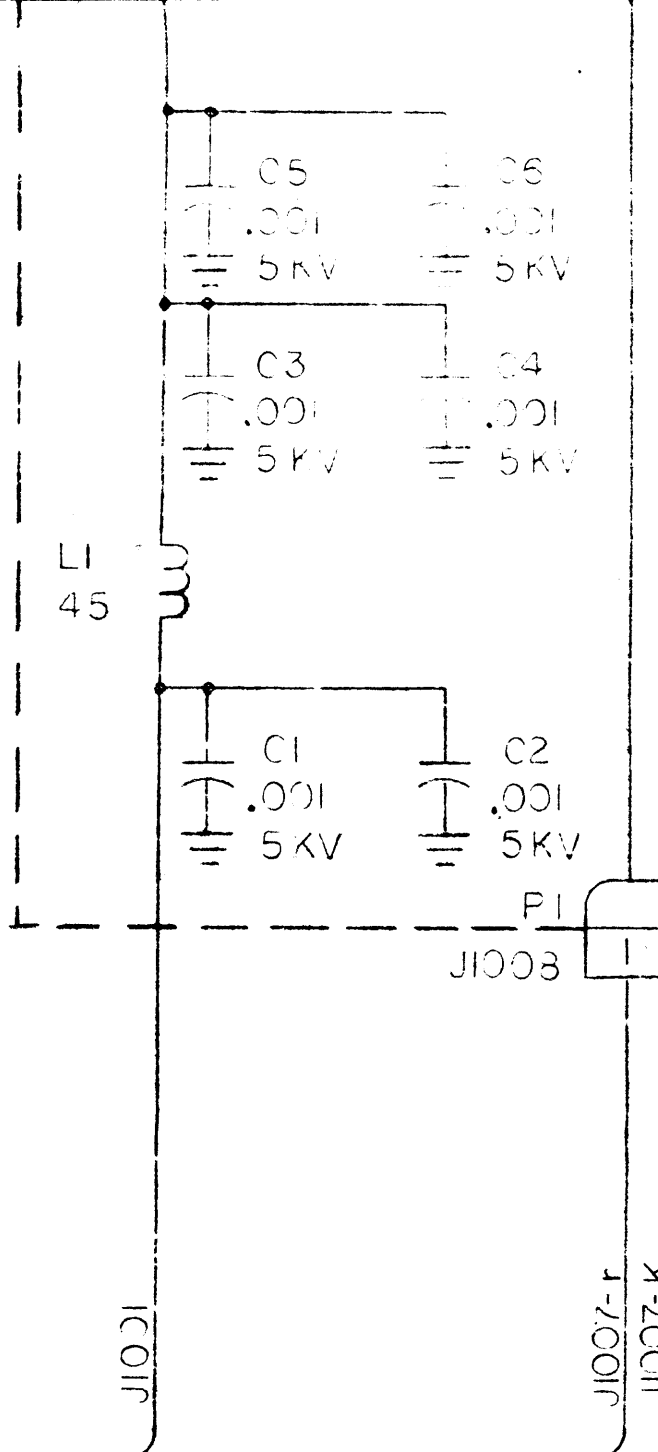

TO SH.2

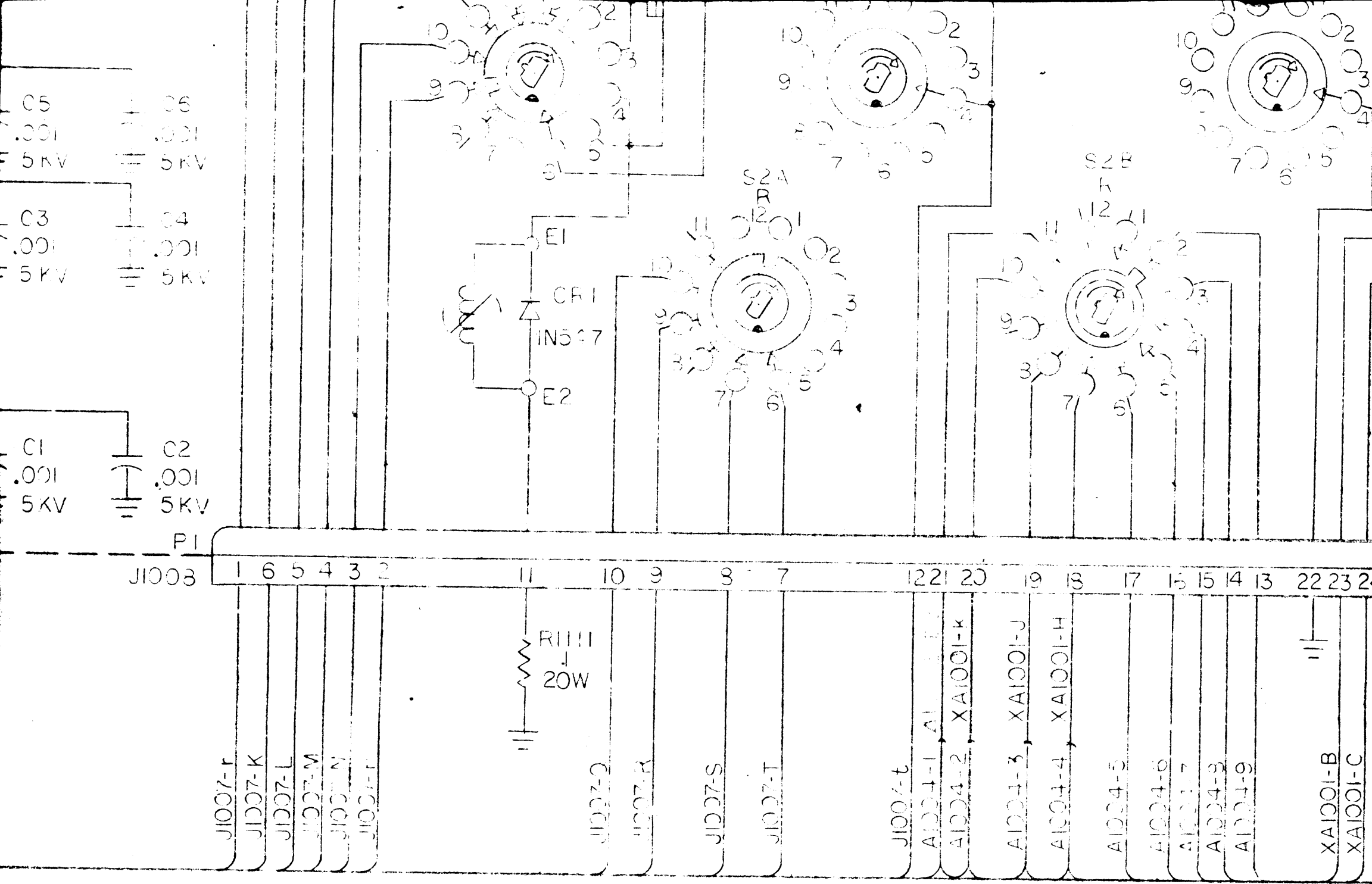

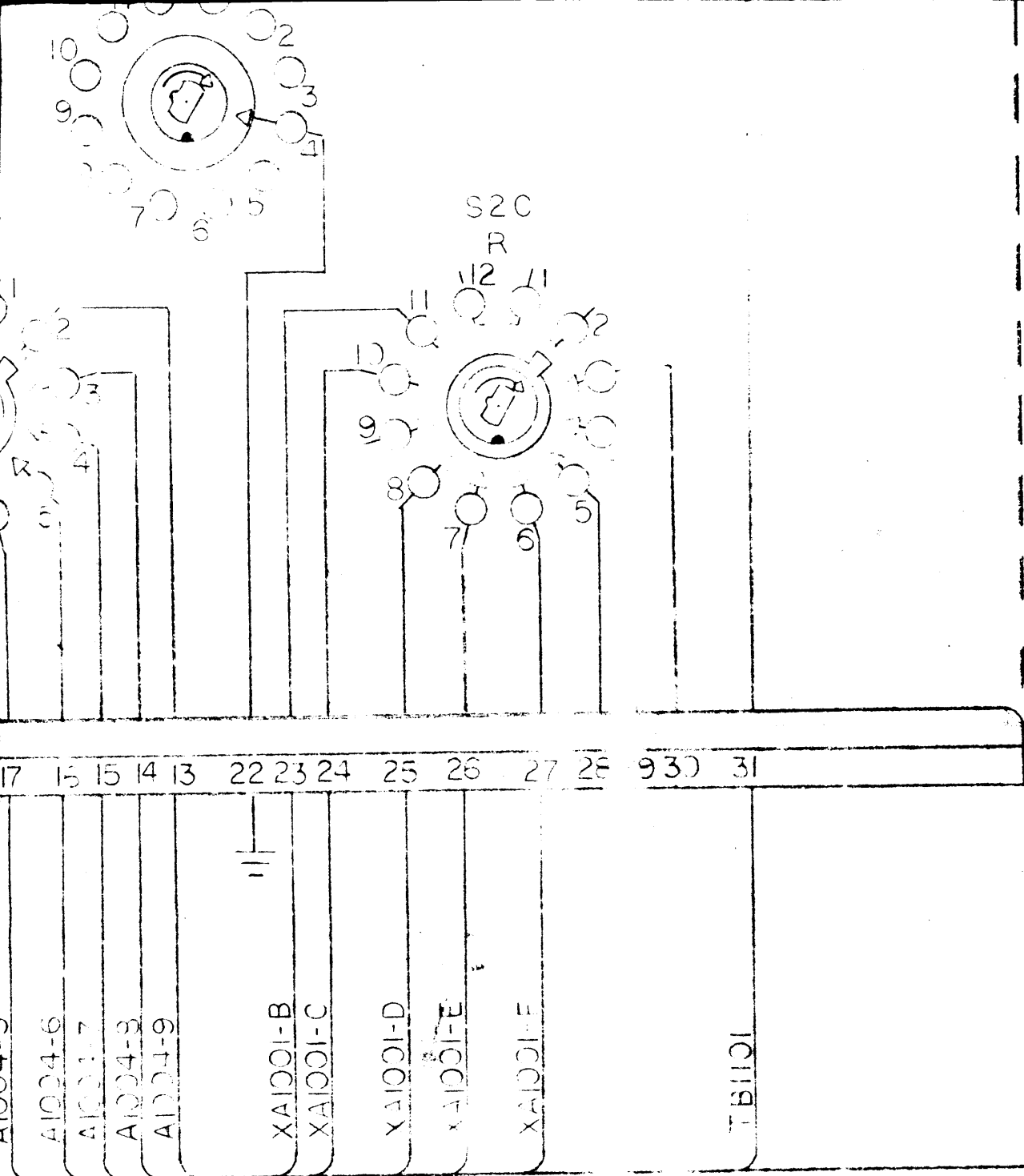

REVISIONS						
ZONE	LTR	DESCRIPTION	DATE	E.M.N.NO	DRAFT	CHKD APPD

THE TECHNICAL  
This drawing is to be used  
to manufacture and  
to the user. This

QTY

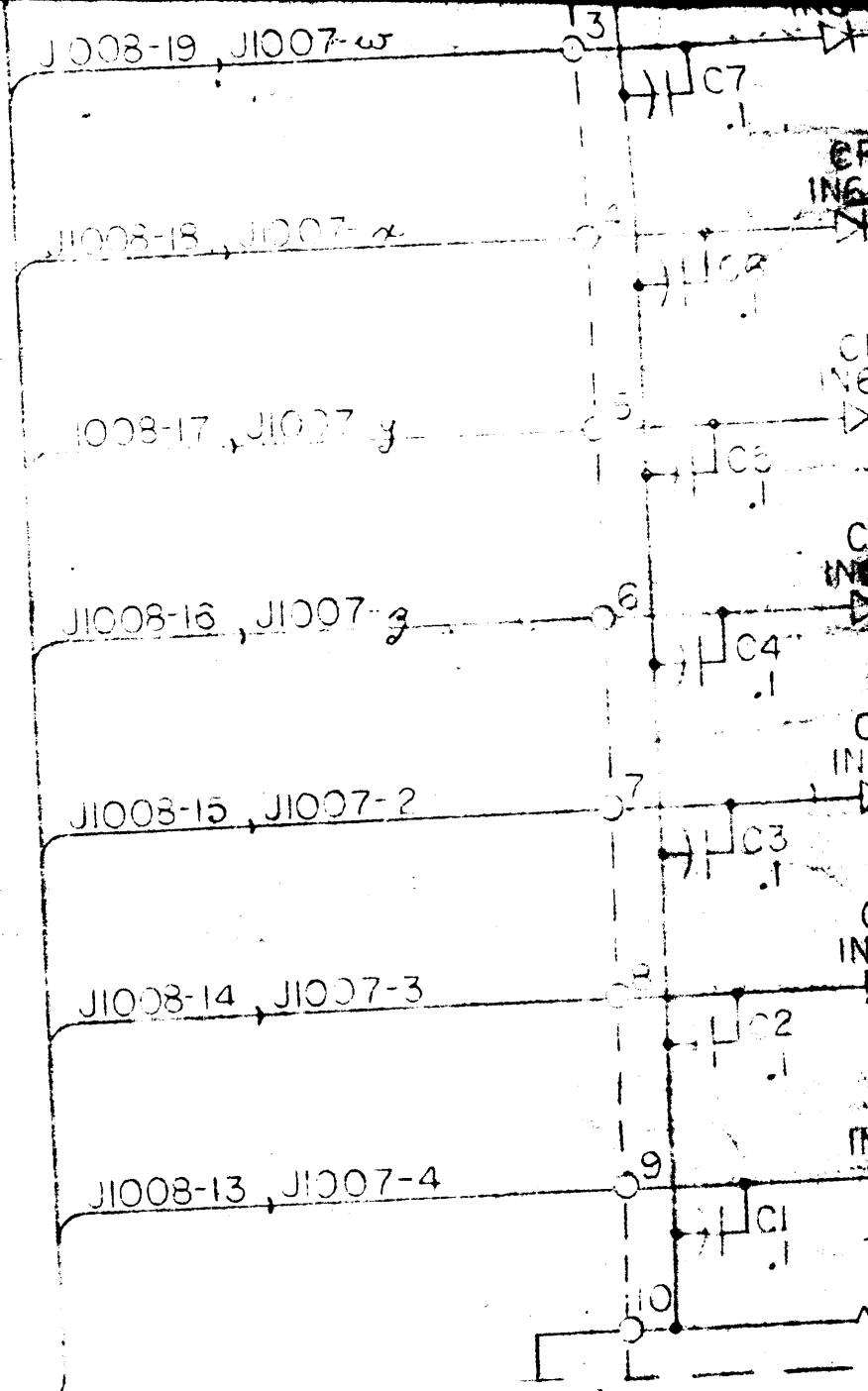

Figure 7-3

TLAM-1KA  
SCHEMATIC DIAGRAM

Sheet - 3 of 3

**NOTICE TO PERSONS RECEIVING THIS DRAWING**  
 THE TECHNICAL MATERIEL CORPORATION claims proprietary right in the material disclosed hereon. This drawing is issued in confidence for engineering information only and may not be reproduced or used to manufacture anything shown hereon without permission from THE TECHNICAL MATERIEL CORPORATION to the user. This drawing is loaned for mutual assistance and is subject to recall at any time.

CHKD APPD

QTY	MODEL USED ON	ASS'Y

FINAL APPROVAL	DATE
MECH. DES.	DATE
ELECT. DES.	DATE
CHECKED	DATE
DRAWN GDL	DATE 11-18-19

CK2221-A

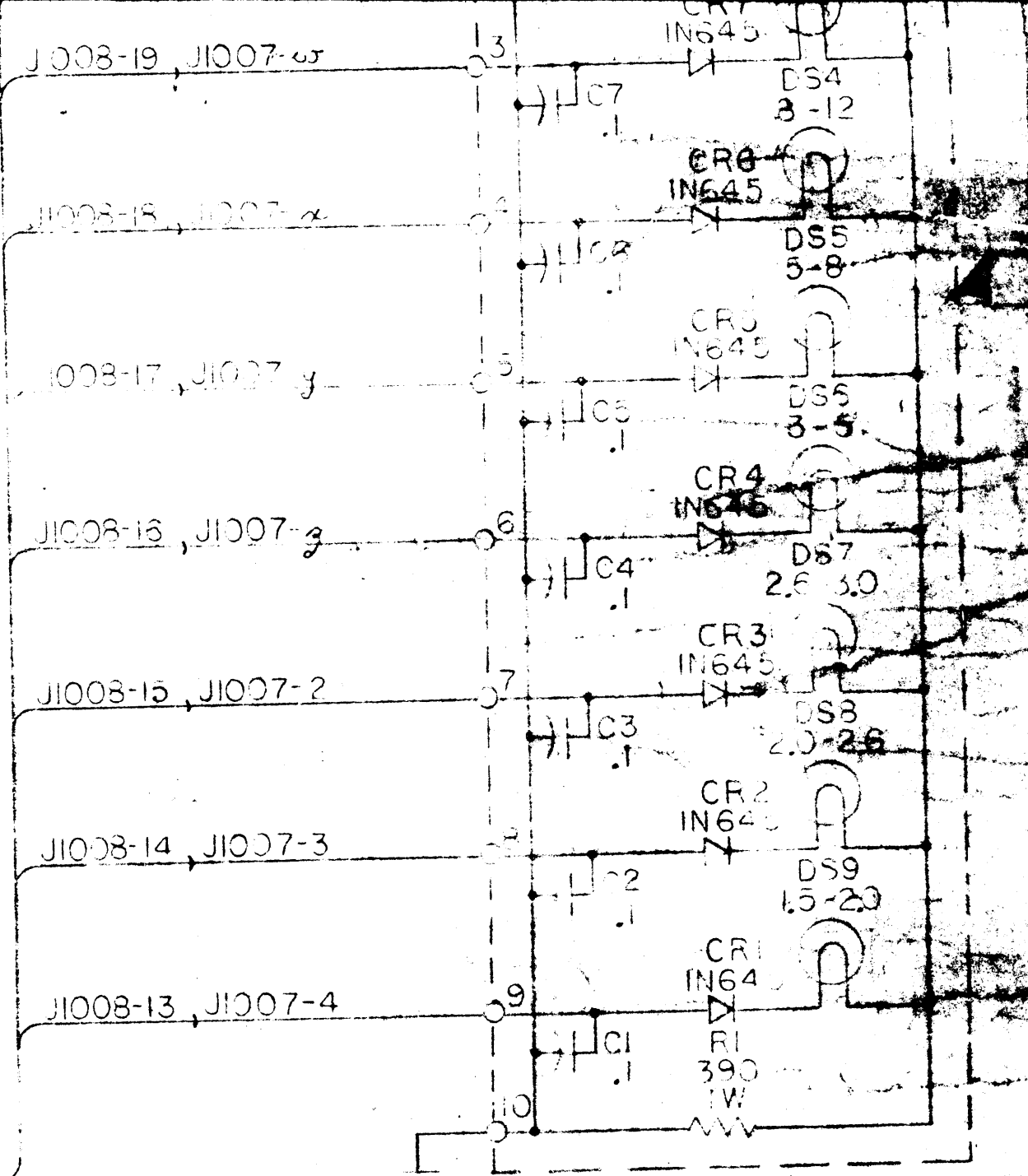

Figure 7-3

TLAM-1KA  
SCHEMATIC DIAGRAM

Sheet - 3 of 3

RECEIVING THIS DRAWING  
claims proprietary right in the material disclosed hereon.  
Engineering information only and may not be reproduced or used  
without permission from THE TECHNICAL MATERIAL CORPORATION  
assistance and is subject to recall at any time.

D ON ASS'Y

FINAL APPROVAL	DATE
MECH DES.	DATE
ELECT. DES.	DATE 7
CHECKED	DATE
DRAWN GDL	DATE 11/19

CK2221-A

7-6