



**MASTER COPY
DO NOT DESTROY**

**MASTER COPY
DO NOT DESTROY**

TECHNICAL MANUAL

FOR
CON-(S)
CONTROL CONSOLE

**RETURN TO MAIN
FILE**

**MASTER COPY
DO NOT DESTROY**

**RETURN TO MAIN
FILE**

PUBLICATION NUMBER
120-060300-000

**RETURN TO MAIN
FILE**

ISSUE DATE
Oct. 1980

THE TECHNICAL MATERIEL CORPORATION

CABLE: TEPEI

700 FENIMORE ROAD, MAMARONECK, NY 10543 U.S.A.
TEL: 914-698-4800

TLX: 137-358

TWX: 710-566-1100

TMC (CANADA) LIMITED

TMC INTERNATIONAL

RR No. 5, Ottawa K1G 3N3 Ontario CANADA

TEL. 613-521-2050

TLX: 053-4146

NOTICE

THE CONTENTS AND INFORMATION CONTAINED IN THIS INSTRUCTION MANUAL IS PROPRIETARY TO THE TECHNICAL MATERIEL CORPORATION TO BE USED AS A GUIDE TO THE OPERATION AND MAINTENANCE OF THE EQUIPMENT FOR WHICH THE MANUAL IS ISSUED AND MAY NOT BE DUPLICATED EITHER IN WHOLE OR IN PART BY ANY MEANS WHATSOEVER WITHOUT THE WRITTEN CONSENT OF THE TECHNICAL MATERIEL CORPORATION.

RECORD OF REVISIONS

NO.	ISSUED	DESCRIPTION	ENTERED	BY
001				
002				
003				
004				
005				
006				
007				
008				
009				
010				

NOTE: Please file Technical Newsletters at back of manual for permanent record.

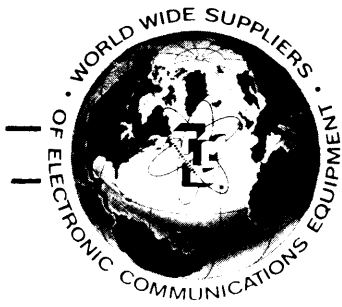

THE TECHNICAL MATERIEL CORPORATION

C O M M U N I C A T I O N S E N G I N E E R S

700 FENIMORE ROAD

MAMARONECK, N. Y.

W a r r a n t y

The Technical Materiel Corporation, hereinafter referred to as TMC, warrants the equipment (except electron tubes, *fuses, lamps, batteries and articles made of glass or other fragile or other expendable materials) purchased hereunder to be free from defect in materials and workmanship under normal use and service, when used for the purposes for which the same is designed, for a period of one year from the date of delivery F.O.B. factory. TMC further warrants that the equipment will perform in a manner equal to or better than published technical specifications as amended by any additions or corrections thereto accompanying the formal equipment offer.

TMC will replace or repair any such defective items, F.O.B. factory, which may fail within the stated warranty period, PROVIDED:

1. That any claim of defect under this warranty is made within sixty (60) days after discovery thereof and that inspection by TMC, if required, indicates the validity of such claim to TMC's satisfaction.
2. That the defect is not the result of damage incurred in shipment from or to the factory.
3. That the equipment has not been altered in any way either as to design or use whether by replacement parts not supplied or approved by TMC, or otherwise.
4. That any equipment or accessories furnished but not manufactured by TMC, or not of TMC design shall be subject only to such adjustments as TMC may obtain from the supplier thereof.

Electron tubes furnished by TMC, but manufactured by others, bear only the warranty given by such other manufacturers. Electron tube warranty claims should be made directly to the manufacturer of such tubes.

TMC's obligation under this warranty is limited to the repair or replacement of defective parts with the exceptions noted above.

At TMC's option any defective part or equipment which fails within the warranty period shall be returned to TMC's factory for inspection, properly packed with shipping charges prepaid. No parts or equipment shall be returned to TMC, unless a return authorization is issued by TMC.

No warranties, express or implied, other than those specifically set forth herein shall be applicable to any equipment manufactured or furnished by TMC and the foregoing warranty shall constitute the Buyers sole right and remedy. In no event does TMC assume any liability for consequential damages, or for loss, damage or expense directly or indirectly arising from the use of TMC Products, or any inability to use them either separately or in combination with other equipment or materials or from any other cause.

*Electron tubes also include semi-conductor devices.

PROCEDURE FOR RETURN OF MATERIAL OR EQUIPMENT

Should it be necessary to return equipment or material for repair or replacement, whether within warranty or otherwise, a return authorization must be obtained from TMC prior to shipment. The request for return authorization should include the following information:

1. Model Number of Equipment.
2. Serial Number of Equipment.
3. TMC Part Number.
4. Nature of defect or cause of failure.
5. The contract or purchase order under which equipment was delivered.

PROCEDURE FOR ORDERING REPLACEMENT PARTS

When ordering replacement parts, the following information must be included in the order as applicable:

1. Quantity Required.
2. TMC Part Number.
3. Equipment in which used by TMC or Military Model Number.
4. Brief Description of the Item.
5. The *Crystal Frequency* if the order includes crystals.

PROCEDURE IN THE EVENT OF DAMAGE INCURRED IN SHIPMENT

TMC's Warranty specifically excludes damage incurred in shipment to or from the factory. In the event equipment is received in damaged condition, the carrier should be notified immediately. Claims for such damage should be filed with the carrier involved and not with TMC.

All correspondence pertaining to Warranty Claims, return, repair, or replacement and all material or equipment returned for repair or replacement, within Warranty or otherwise, should be addressed as follows:

THE TECHNICAL MATERIEL CORPORATION
Engineering Services Department
700 Fenimore Road
Mamaroneck, New York

TABLE OF CONTENTS

<u>Paragraph</u>		<u>Page</u>
<u>SECTION 1 - GENERAL INFORMATION</u>		
1-1	Functional Description	1-1
1-2	Physical Description	1-2
<u>SECTION 2 - INSTALLATION</u>		
2-1	Introduction	2-1
2-2	Unpacking	2-1
2-3	Assembling	2-1
2-4	Initial Test	2-1
2-5	Technical Specifications	2-2
<u>SECTION 3 - OPERATORS SECTION</u>		
3-1	General	3-1
3-2	Operating Controls and Indicators.	3-1
<hr/>		
<u>SECTION 4 - PRINCIPLES OF OPERATION</u>		
4-1	General	4-1
4-2	Recorders Operation	4-1
4-3	Oscilloscope Operation	4-2
4-4	Power Distribution	4-3
4-5	Main Power Indication	4-3
4-6	High Voltage Control	4-3
4-7	Aural Alarm.	4-4
4-8	Overload Reset	4-4
<u>SECTION 5 - MAINTENANCE</u>		
5-1	General Information	5-1
5-2	Preventive Maintenance	5-1
5-3	Minor Repair	5-2
<u>SECTION 6 - PARTS LIST</u>		

LIST OF TABLES

<u>Table</u>		<u>Page</u>
<u>SECTION 1 - GENERAL INFORMATION</u>		
1-1	Recorders (Appendix A) - Oscilloscope (Appendix B)	1-1
1-2	Items Supplied	1-3
<u>SECTION 3 - OPERATORS SECTION</u>		
3-1	Operating Controls and Indicators	3-2

LIST OF ILLUSTRATIONS

<u>Figure</u>		<u>Page</u>
<u>SECTION 1 - GENERAL INFORMATION</u>		
1-0	Operating Console Model CON-(S)	1-0
1-1	Rear Panel Component Locations	1-2
1-2	Interconnections	1-3
<u>SECTION 2 - INSTALLATION</u>		
2-1	Console CON-(S) Installation	2-3
2-2	Console CON-(S) Interwiring	2-4
<u>SECTION 3 - OPERATORS SECTION</u>		
3-1	Controls and Indicators	3-4
<u>SECTION 4 - PRINCIPLES OF OPERATION</u>		
4-1	Schematic Diagram Overall Console	4-6

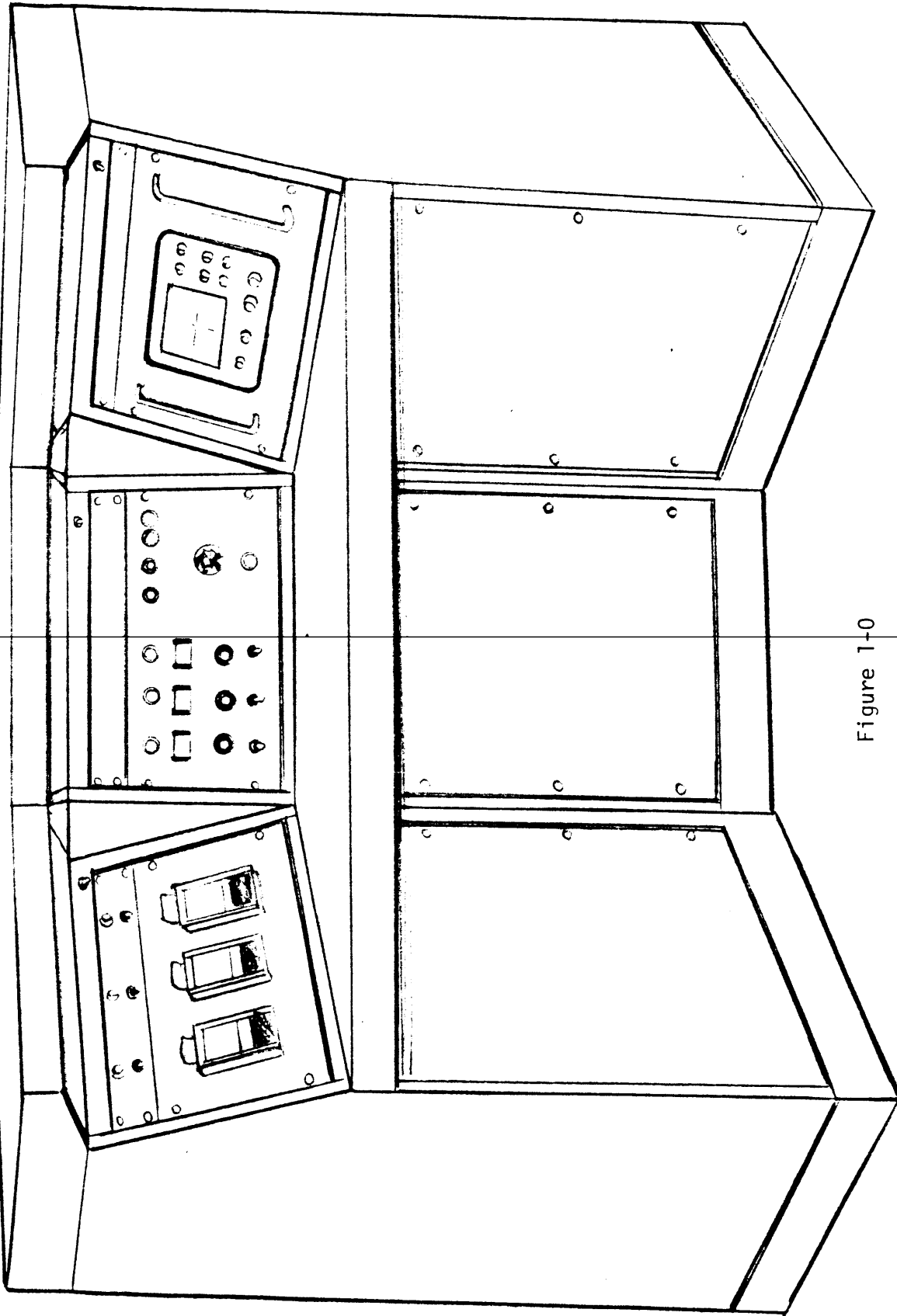

Figure 1-0
Operating Console
Model CON-(S)

SECTION 1
GENERAL INFORMATION

1-1. FUNCTIONAL DESCRIPTION

The Technical Materiel Corporation's, Operating Console, Model CON-(S) was specially designed to be used as an operating, monitoring and recording console used specifically in consort with three (3) HFLM-10K transmitters.

The CON-(S) hereafter to be referred to as console, is a three, rack U-shaped desk style cabinet, which houses from left to right three recorders, control components and oscilloscope. Refer to figure 1-0 for a pictorial representation.

The recorders will document a sampling of ALDC Voltage derived directly from the ALDC Amplifiers of the HFLM-10K.

The oscilloscope will monitor a sampling of RF derived for the RF output of the HFLM-10K.

Refer to appendix A and B for detailed information pertaining to the recorders and oscilloscope as listed in table 1-1.

TABLE 1-1

Recorders	Appendix A
Oscilloscope	Appendix B

1-2. PHYSICAL DESCRIPTION

The overall size of the console is approximately 80 inches wide by 36 inches deep, and stands 47 inches high. Each Rack contains it's own AC strip which are located in the rear left hand side of each rack.

Three terminal strips are located on the rear panel of the center rack or control rack. This panel is recessed and a cover must be removed for access.

Each terminal strip is marked with a transmitter designation XMTR-1, XMTR-2, XMTR-3. See figure 1-1 for rear panel designations and figure 1-1 for Interconnect information. Table 1-2 list the Loose Items supplied.

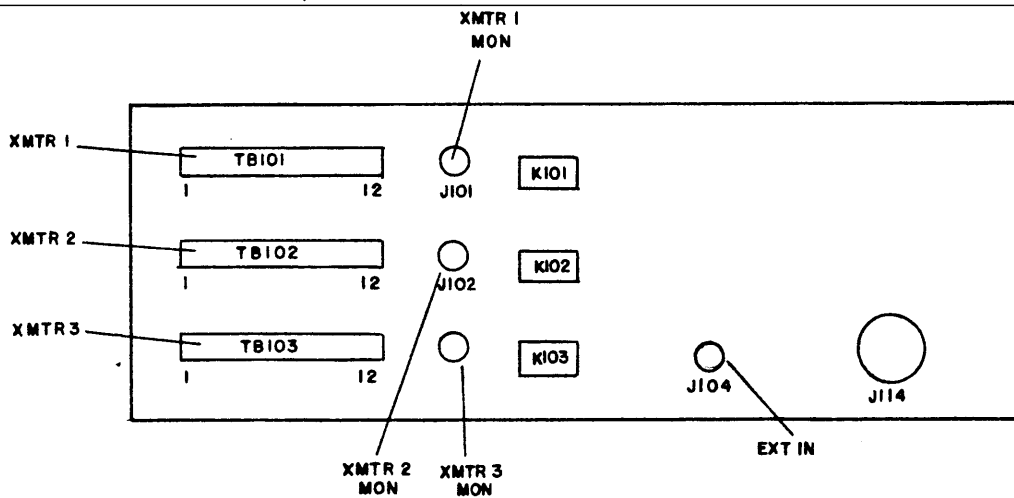

Figure 1-1
Rear Panel Component Locations

Table 1-2

ITEMS SUPPLIED		
PART NO.	DESCRIPTION	QUANTITY
TM102-12	Faning Strip	3
PL-244-1	BNC Connectors	4
JJ-297	AC Line Connector	1
	Technical Manual	1

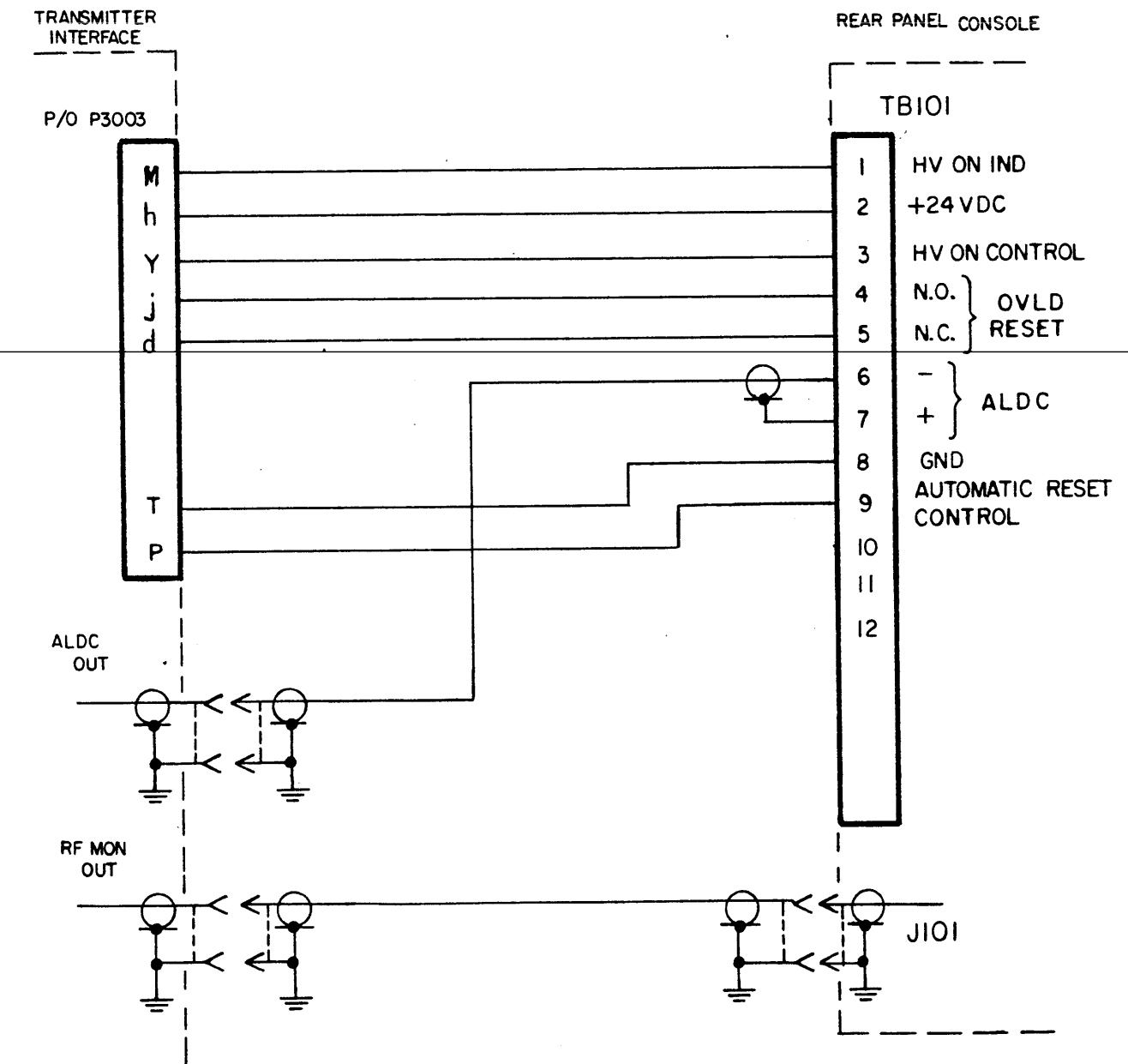

Figure 1-2
Interconnection Console to Transmitter
Typical for each Transmitter

Section 2

INSTALLATION

2-1. INTRODUCTION

The Model CON-(S) Console is tested by The Technical Materiel Corporation in conjunction with the HFLM-10K Transmitters.

2-2. UNPACKING

All the components of the CON-(S) Console, when received at the installation site, should be carefully examined to be sure no damage occurred during shipment. All necessary precautions are taken by The Technical Materiel Corporation to minimize shipping hazards. If any such damage is discovered, a claim should be filed with the carrier.

The Technical Materiel Corporation will assist in rectifying any damage by recommending replacement parts and by describing repair methods.

2-3. ASSEMBLING

The Console CON-(S) is broken down into sections for ease of shipping and safety for the equipment.

Figure 2-1 illustrates the rack positions and assembling details. Figure 2-2 illustrates the consoles interwiring and connections.

2-4. INITIAL TEST

The ease with which the proper operation of the console can be assured when integrated into a transmitter system is a highly desired feature. The initial test of the CON-(S) Console should, therefore, follow the normal operating procedure given in Section 3 of this presentation. Of prime consideration is the fact that the transmitters must be in proper working condition in the local or non-remoted mode of operation. When remote control is accomplished, all controls must be positioned so as not to inhibit proper remote operation.

DESK SUPPORT

REAR COVER

INTERCONNECT CABLE

REAR FILLER

FRONT FILLER

XMT

TOP

DESK LIGHT

INTERCONNECT CABLE

RAK N°1

D

C

B

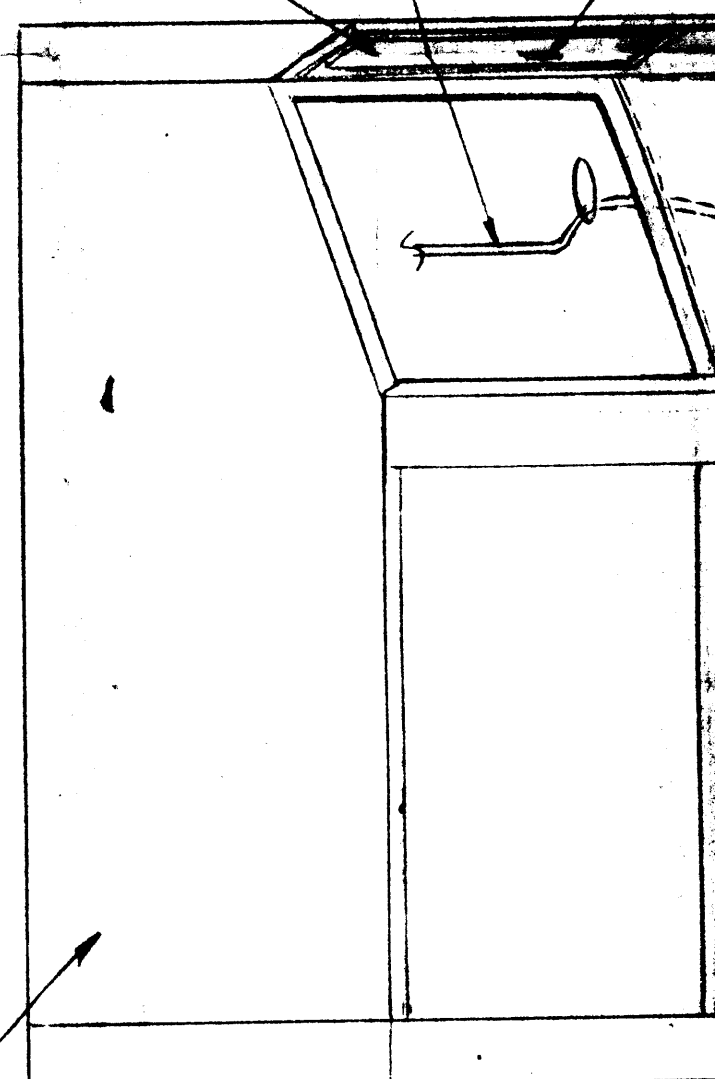
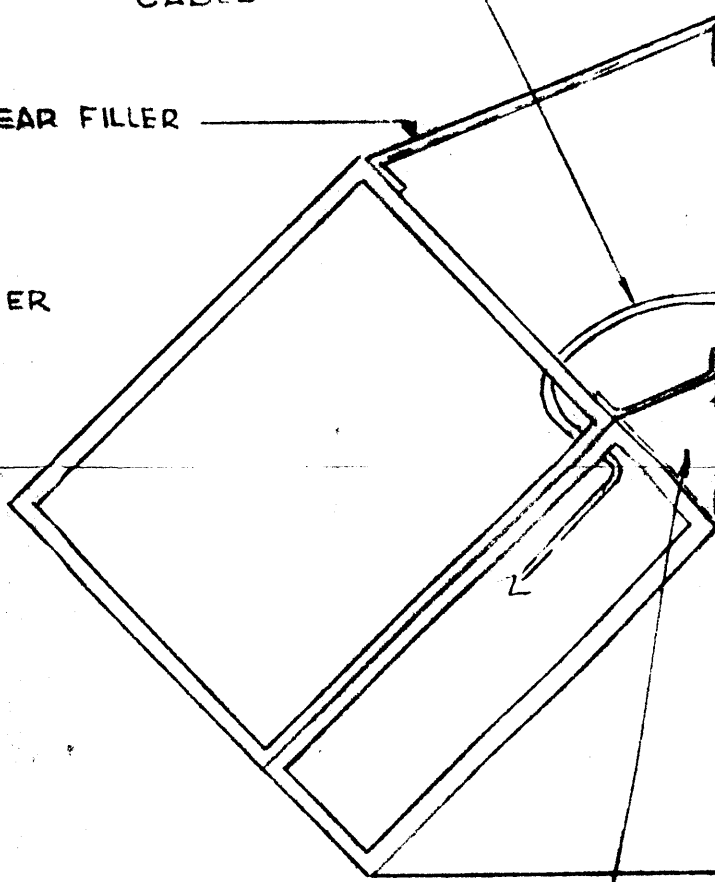
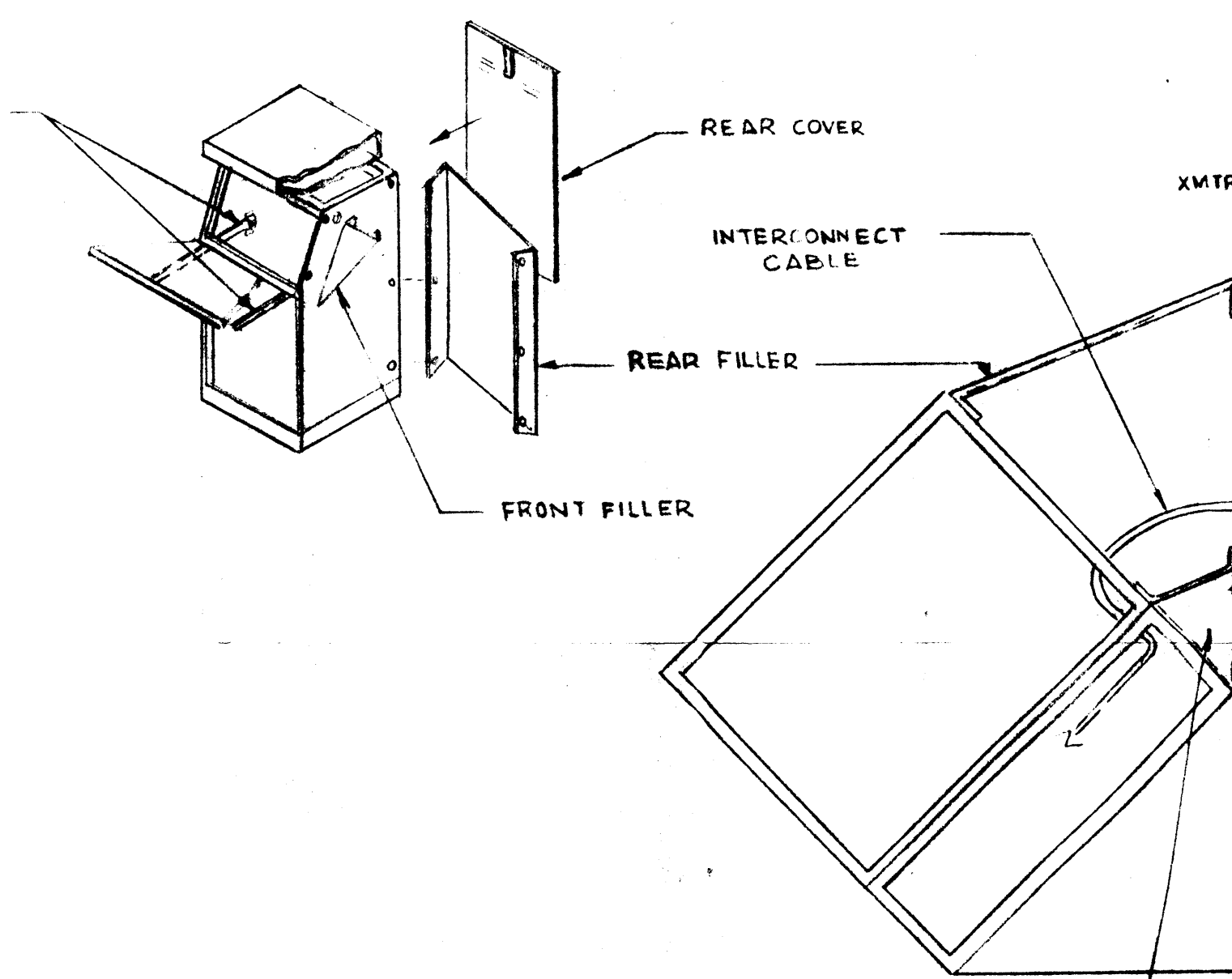

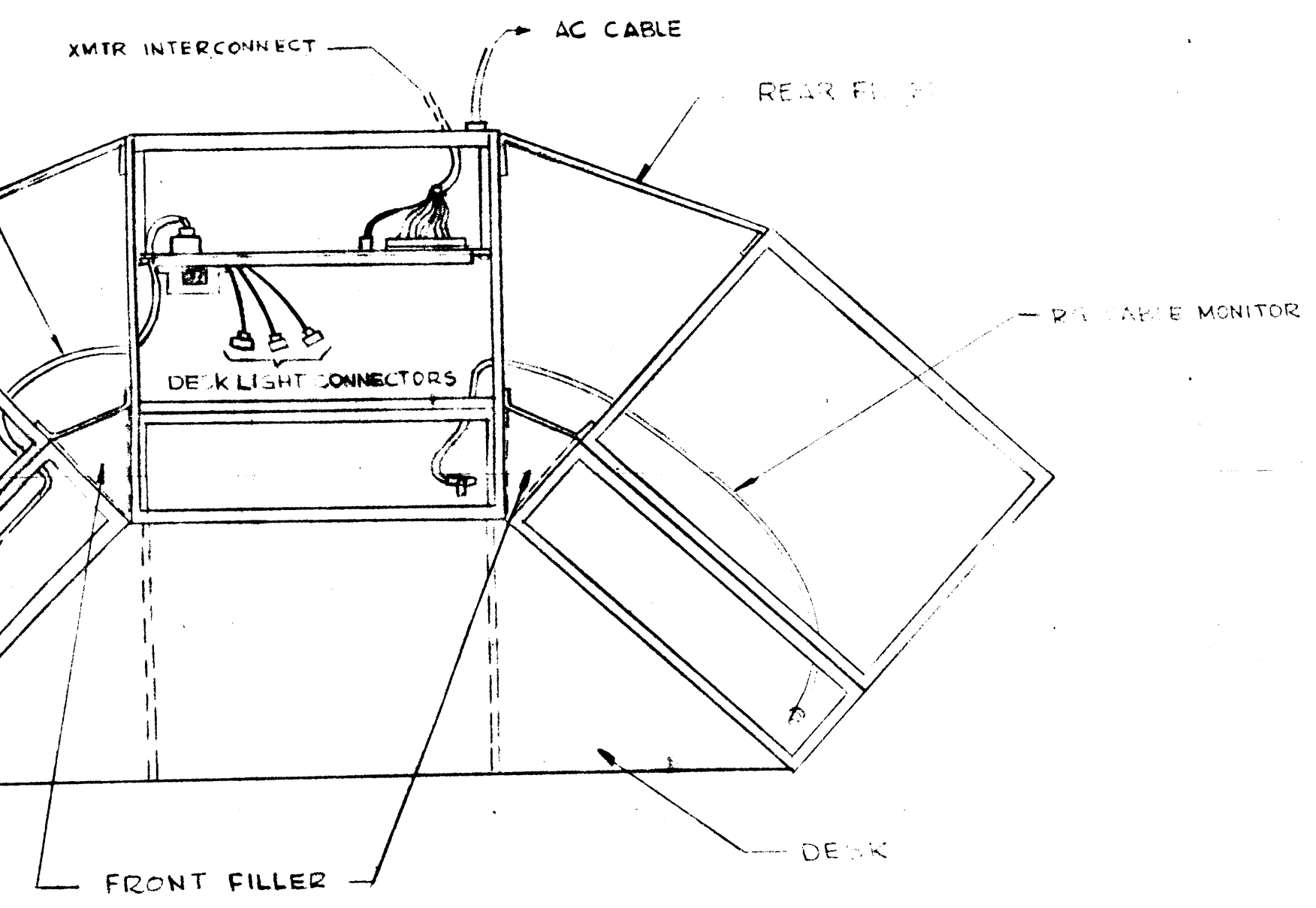

TOP VIEW WITH OUT COVER

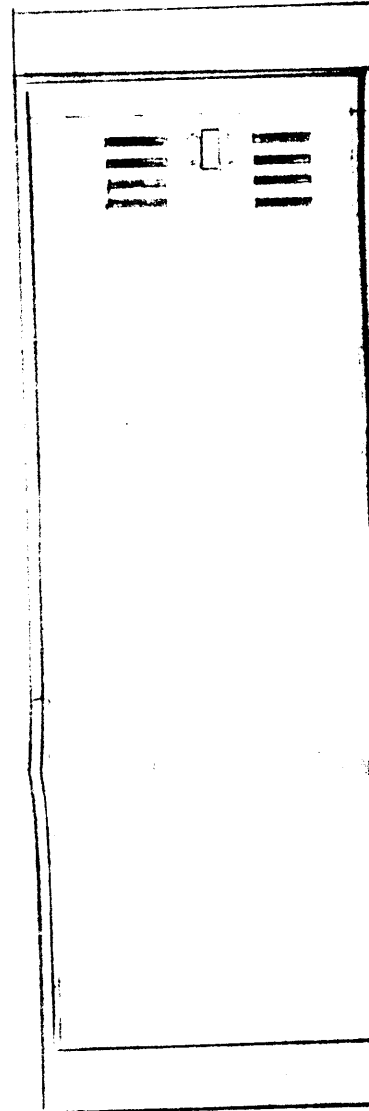
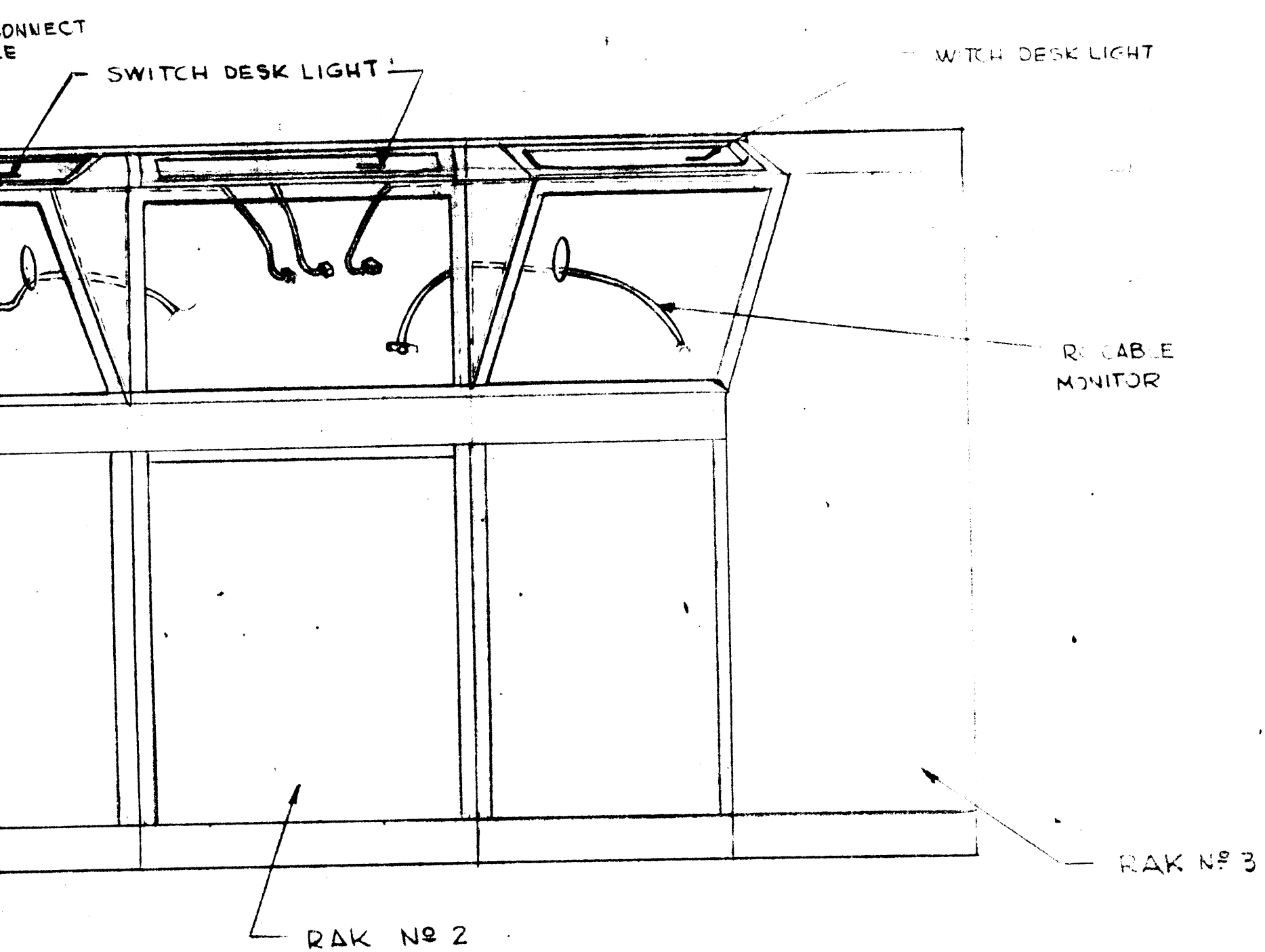

					REVISIONS			
E.M.N.NO	DRAFT	CHKD	ZONE	LTR	DESCRIPTION	DATE	APPROVED	

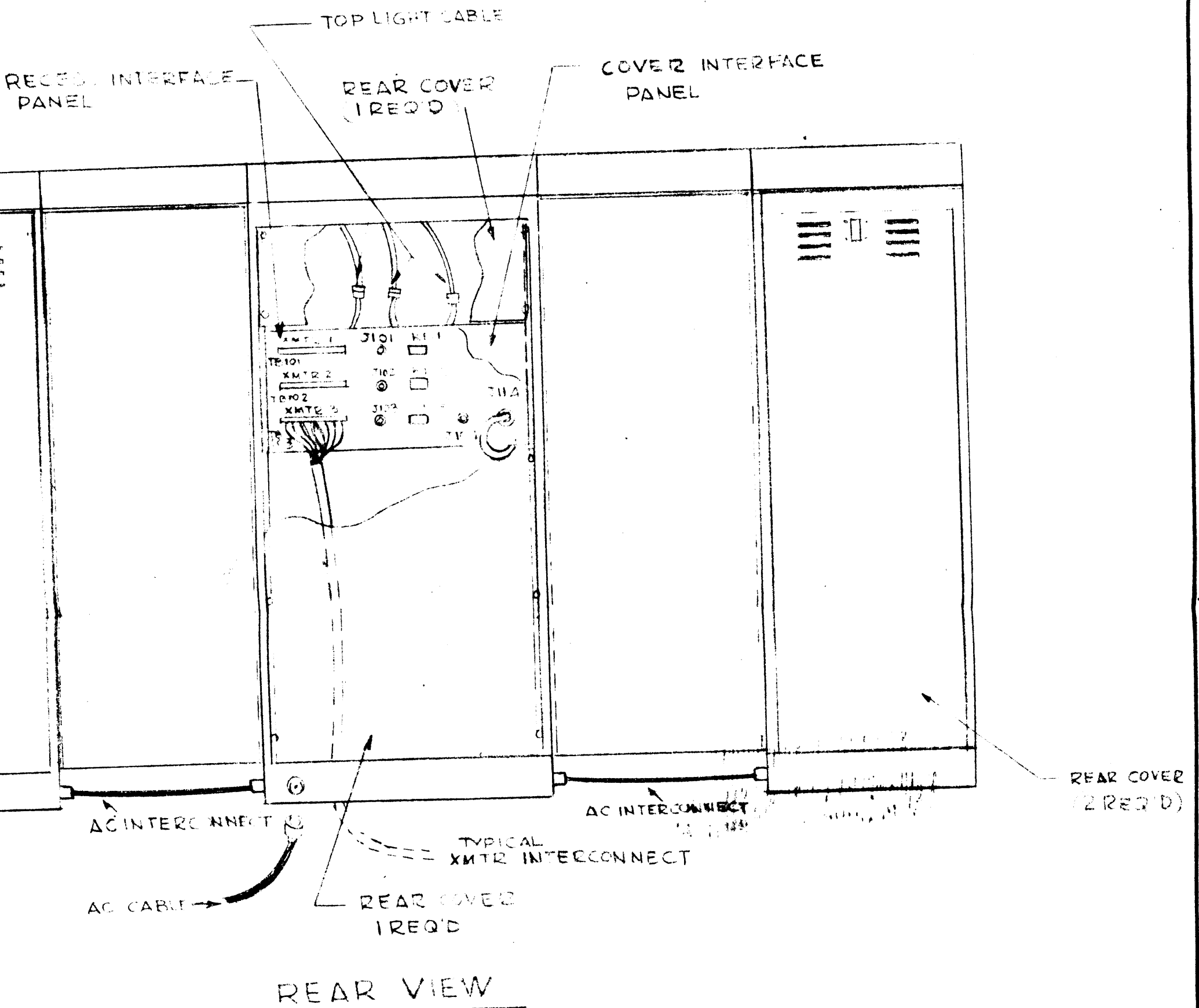

C

B

A

8

7

6

DESK LIGHT

INTERCONNECT
CABLE

RAK N°1

TOP

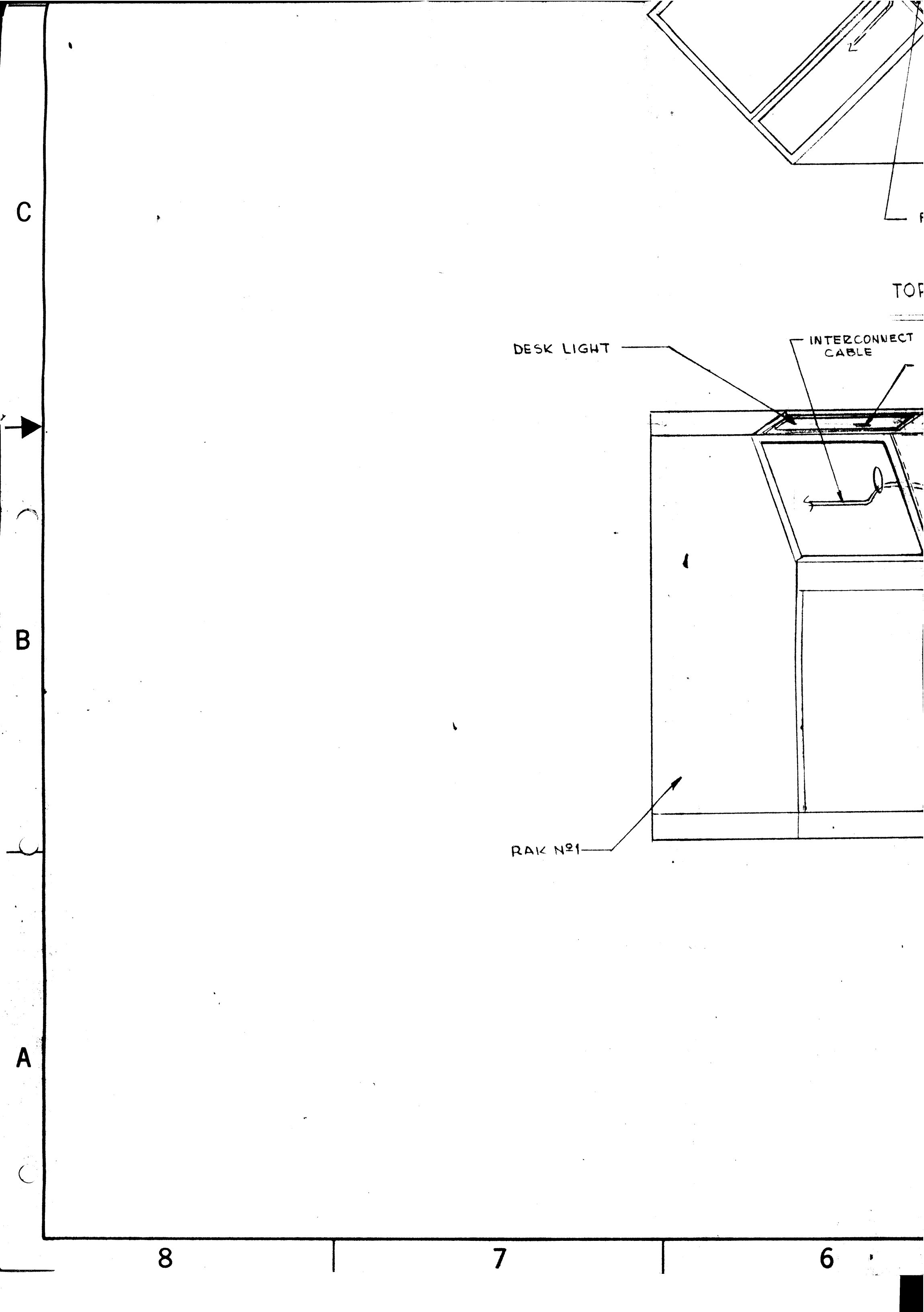

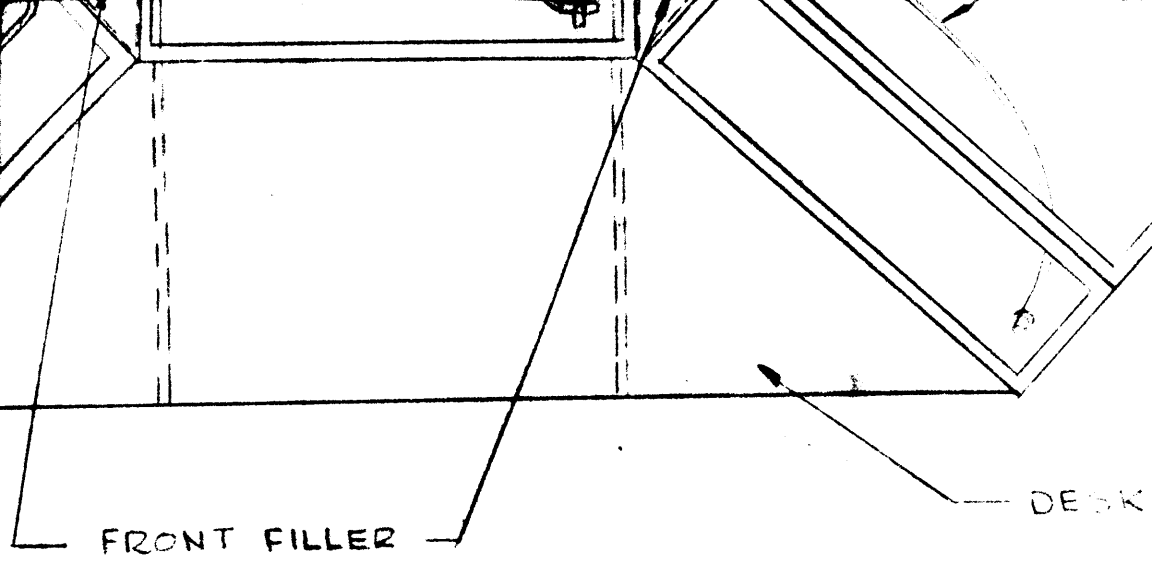

TOP VIEW WITH OUT COVER

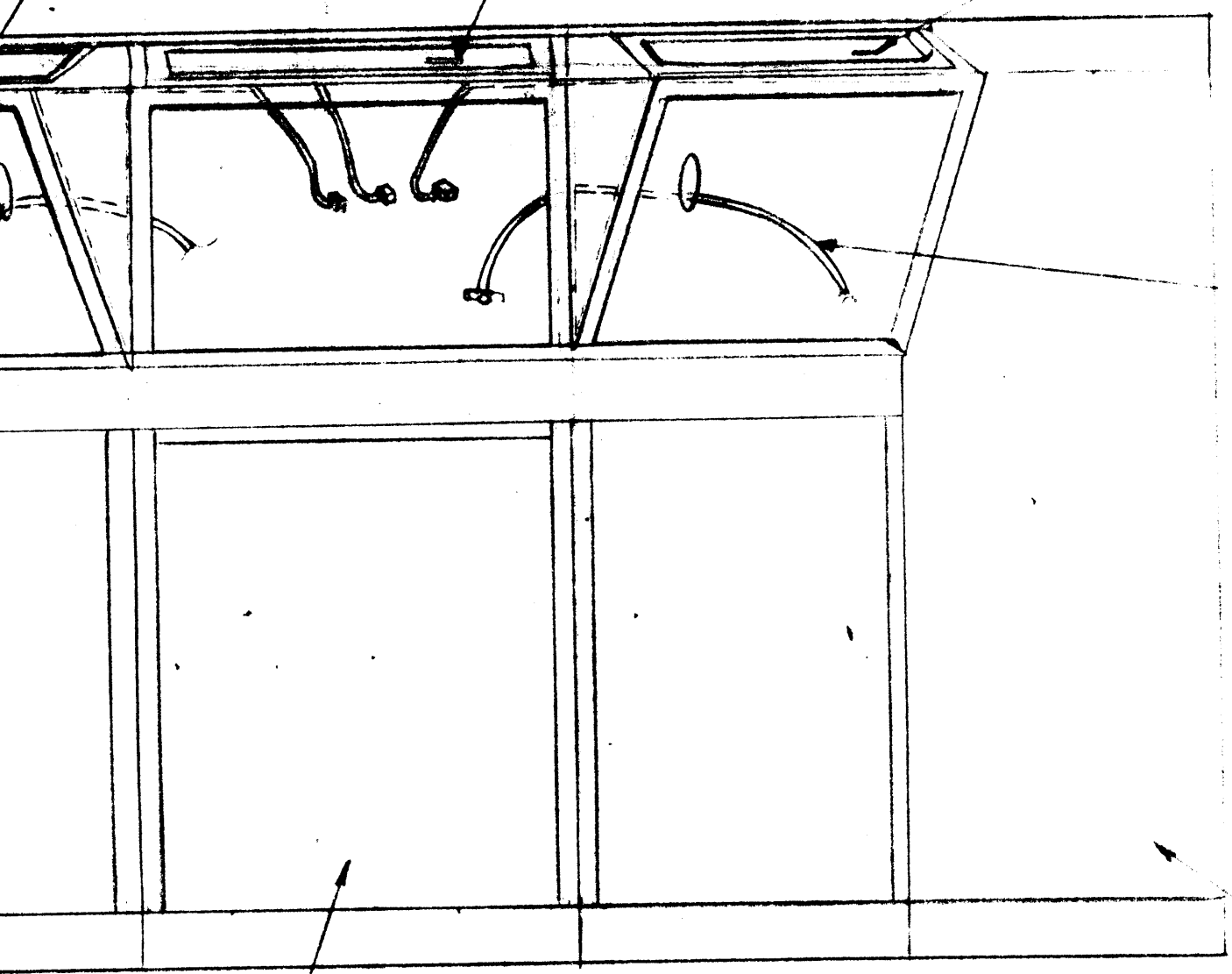
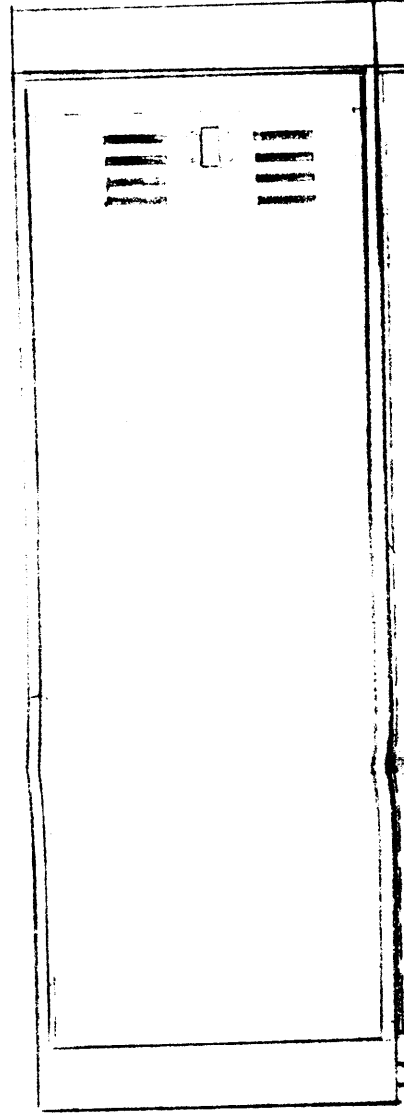
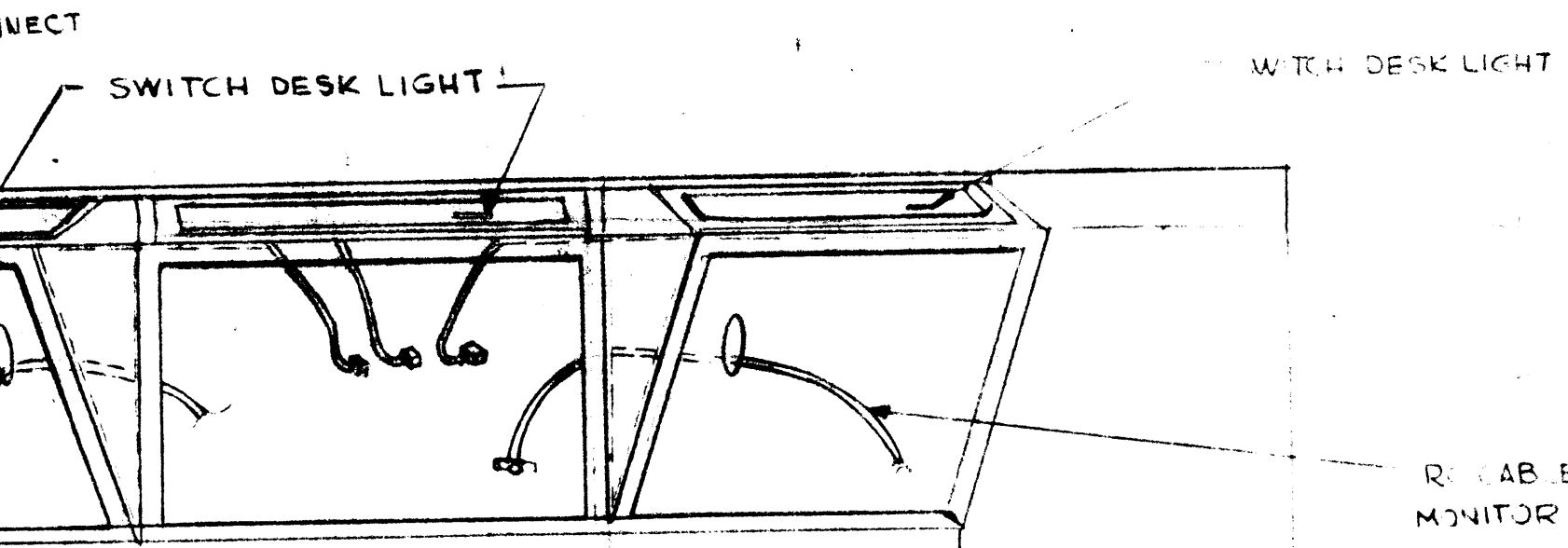

RE CABLE
MONITOR

RAK No 2

RAK No 3

FRONT VIEW

QTY / UNIT	MODEL USED ON	ASS'Y NO.
APPLICATION		
	CODE	

NOTICE TO PERSONS RECEIVING THIS DRAWING
 THE TECHNICAL MATERIEL CORPORATION claims proprietary right in the material disclosed hereon. This drawing is issued in confidence for engineering information only and may not be reproduced or used to manufacture anything shown hereon without permission from THE TECHNICAL MATERIEL CORPORATION to the user. This drawing is loaned for mutual assistance and is subject to recall at any time.

UNL
DIM
AND IN

DEC
.X
.XX
.XXX

MATER

FINISH

5



4

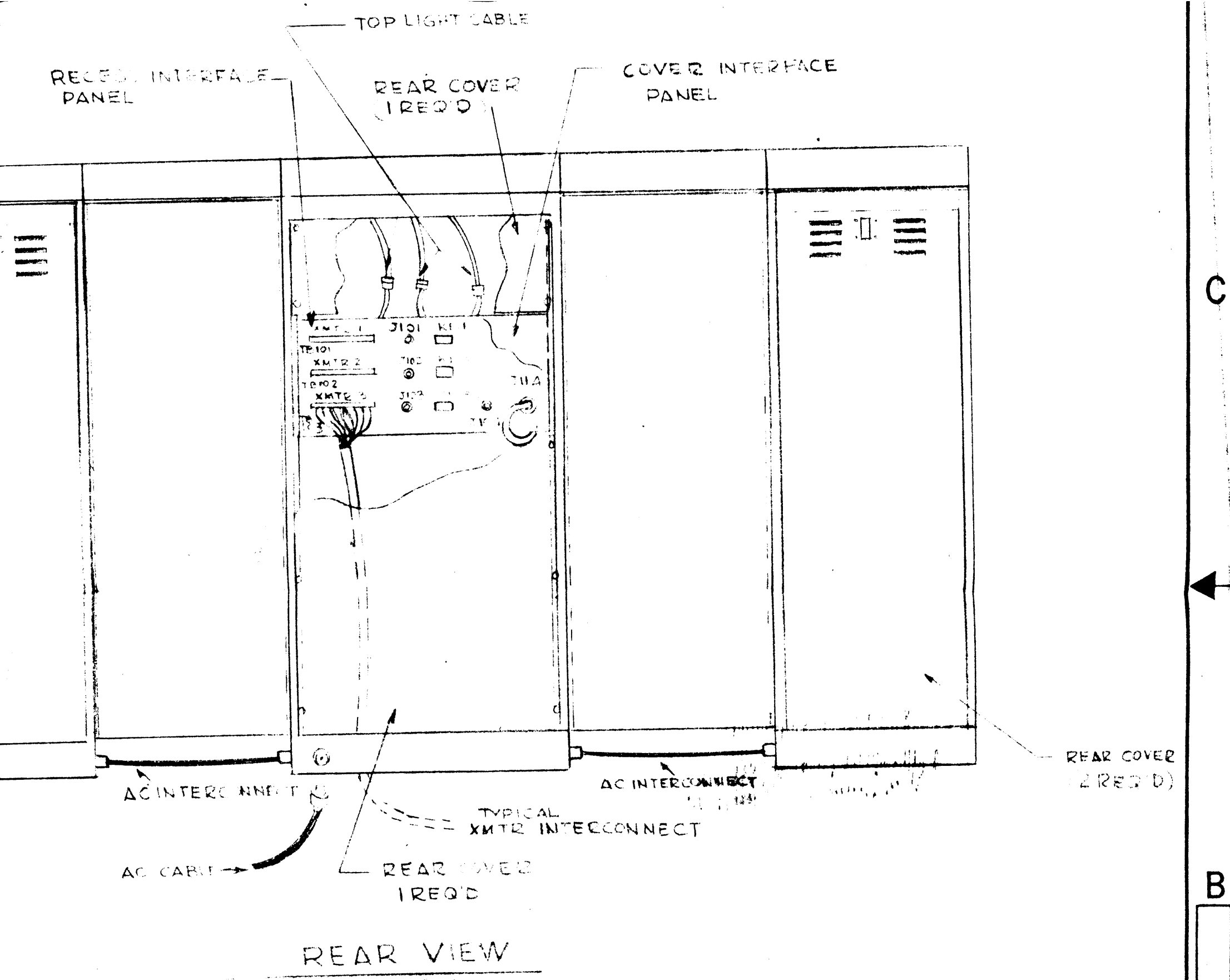

QTY. REQ.	ITEM	PART NO.	DESCRIPTION	SYMBOL
LIST OF MATERIAL				
UNLESS OTHERWISE SPECIFIED DIMENSIONS ARE IN INCHES AND INCLUDE CHEMICALLY APPLIED OR PLATED FINISHES		FINAL APPROVAL		
TOLERANCES ON		MECH. DES.		
DECIMALS	FRACTIONS	ELECT. DES.		
.X ± .05	± 1/64	CHECKED		
.XX ± .01	ANGLES	DRAWN		
.XXX ± .005	± 0° -30'	G.D.L.		
MATERIAL				
FINISH				
		ID447-0		
3	2	1		

Figure 2-1. Console CON-(S) Installation

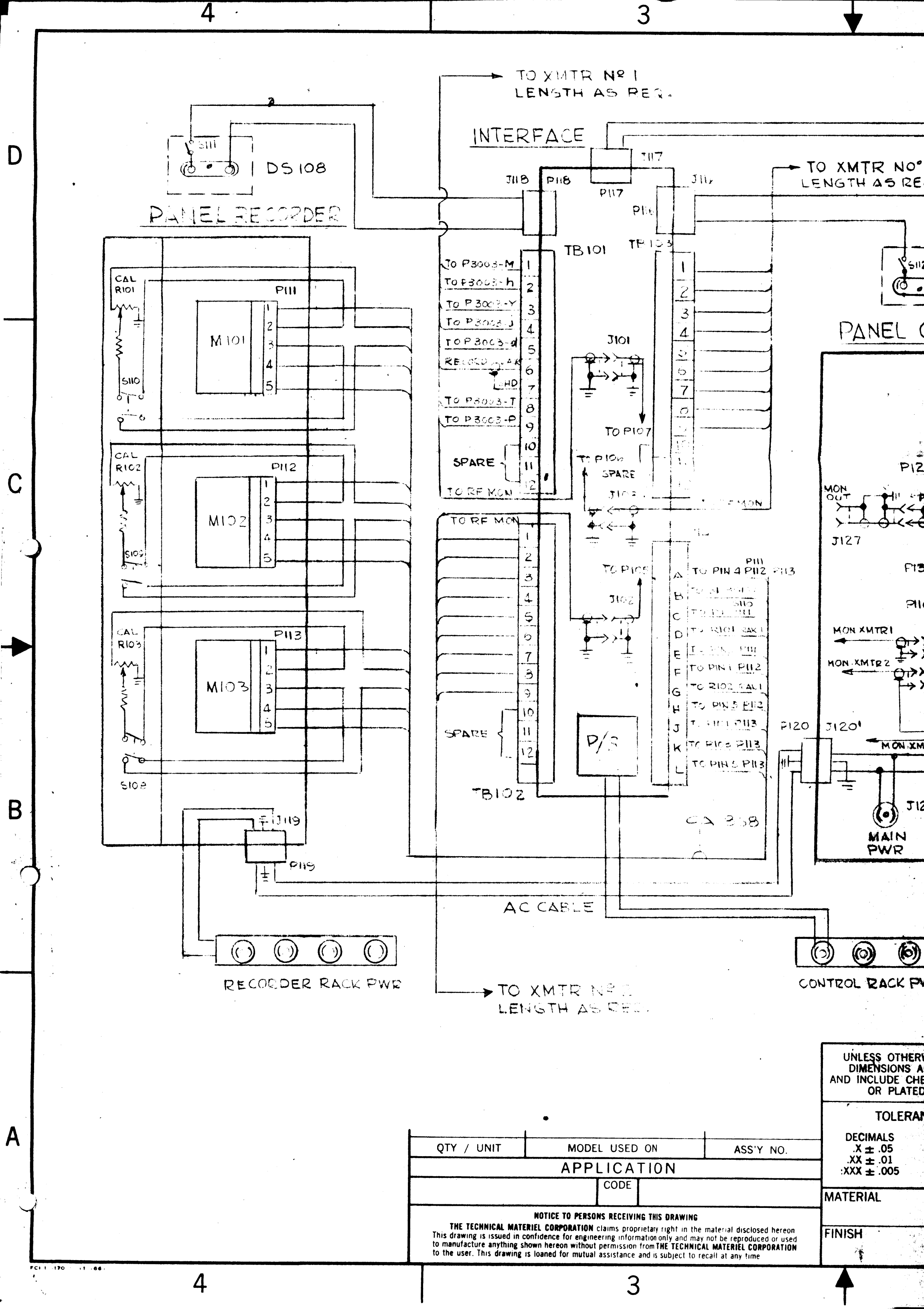

QTY / UNIT	MODEL USED ON	ASS'Y NO.
APPLICATION		
CODE		

NOTICE TO PERSONS RECEIVING THIS DRAWING
 THE TECHNICAL MATERIEL CORPORATION claims proprietary right in the material disclosed hereon. This drawing is issued in confidence for engineering information only and may not be reproduced or used to manufacture anything shown hereon without permission from THE TECHNICAL MATERIEL CORPORATION to the user. This drawing is loaned for mutual assistance and is subject to recall at any time.

UNLESS OTHERWISE SPECIFIED, ALL DIMENSIONS ARE IN INCHES AND INCLUDE CHECKS OR PLATED.

TOLERANCES

DECIMALS
 .X ± .05
 .XX ± .01
 .XXX ± .005

MATERIAL

FINISH

REVISIONS							
ZONE	LTR	DESCRIPTION	DATE	E.M.N.NO	DRAFT	CHKD	APPD

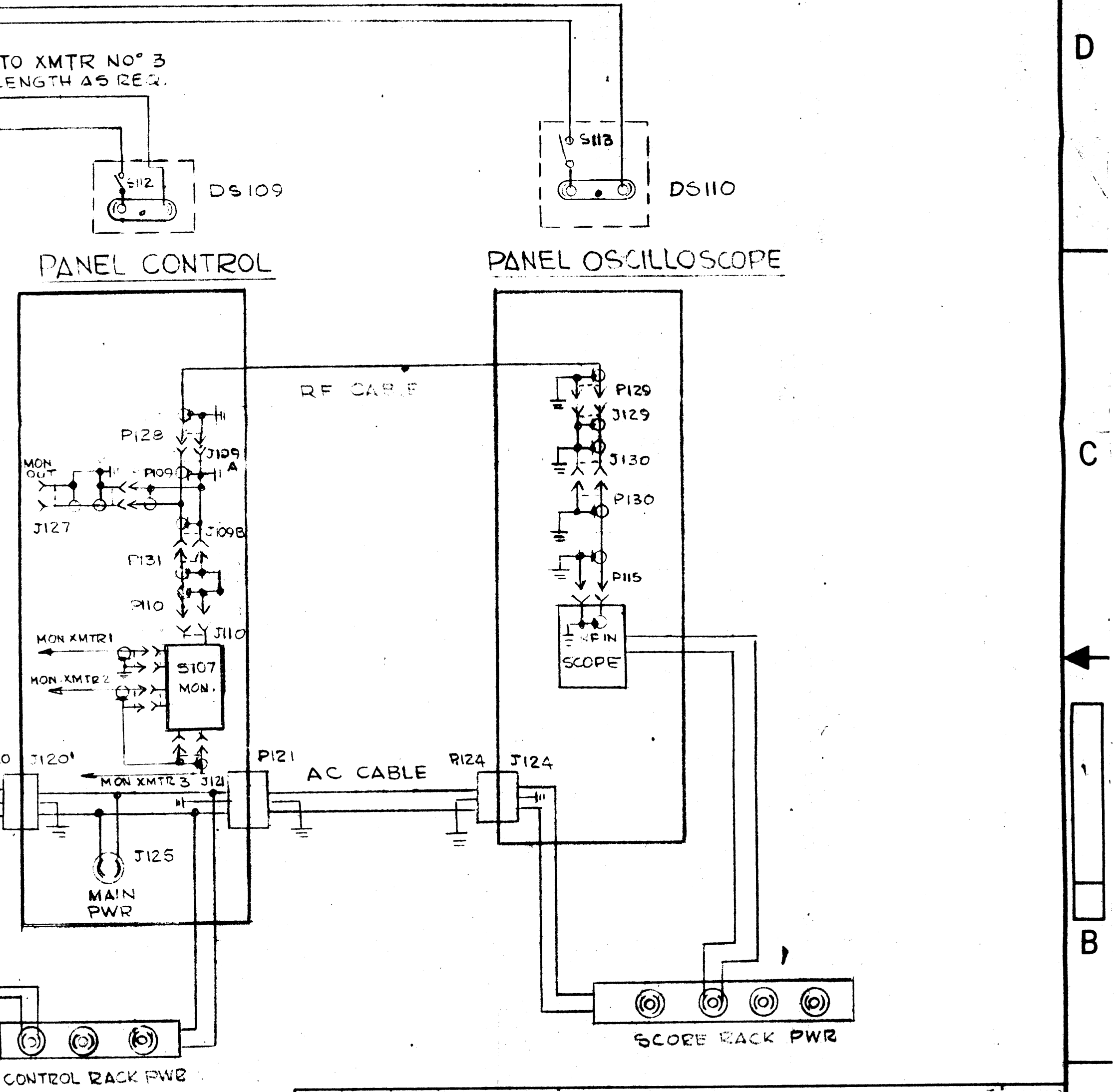

UNLESS OTHERWISE SPECIFIED DIMENSIONS ARE IN INCHES AND INCLUDE CHEMICALLY APPLIED OR PLATED FINISHES	
TOLERANCES ON	
DECIMALS	FRACTIONS
.X ± .05	± 1/64
.XX ± .01	ANGLES
.XXX ± .005	± 0° 30'
MATERIAL	
FINISH	

Figure 2-2. Console CON-(S) Interwiring

CK2235

N39970

SECTION 3
OPERATORS SECTION

3-1 GENERAL

Once the HFLM-10K Transmitters are tuned and indicating the desired RF Output levels see HFLM-10K Manual for tuning procedures. Control and monitoring can be transferred to the console.

At the transmitter the local/remote switch must be switched to remote and the High Voltage switch must be initiated. See Addendum 1 of the HFLM-10K manual. At the console a main power light will illuminate indicating which transmitters are ready for console control and monitoring.

3-2. OPERATING CONTROLS AND INDICATORS

Transmitter control now is transferred to the console. The operator at this juncture must verify AC is present at the console. A line input connector is located at the bottom of the center rack or control rack, when connected to a 115 or 230 AC source a light will illuminate on the control panel. This light is marked "DC".

Individual florescent lamps are located above each rack and their, individual switches are adjacent to each lamp.

It must now be determined which transmitter the operator wishes to control and monitor. Depressing any one of three High Voltage buttons will initiate control of one transmitter. If for example transmitter one "XMTR-1" button is pressed the High Voltage button will illuminate indicating High Voltage is now ON in the transmitter.

The Aural Alarm, located below the XTMR-1 button should now be armed. This is accomplished using the switch located below the Alarm.

The four position transmitter monitor knob determines which transmitter will be monitored "XMTR Mon" is used for the oscilloscope. The oscilloscope is located in the right side rack. Refer to Appendix B for Oscilloscope Operation.

The left side rack houses three recorders one for each transmitter, a switch is supplied adjacent to each recorder which connects each recorder to its mating transmitter. A calibration knob is also present in this area. This adjustment determines the position of the pointer which will record the level of RF output. See Appendix A for recorder instructions.

Table 3-1

OPERATING CONTROLS AND INDICATORS

Index No.	Control and Indicator	Function
1	Florescent Lamps DS108, DS109, DS110	When switched on Illuminates each rack.
2	Switchs for Florescent Lamps S111, S112, S113	Switches on Florescent lamps
3	DC Lamp DS107	When AC is connected indicates console power.
4	High Voltage Illuminating Button S101, S102, S103	Indicates which transmitter has HV on. To initiate, control must be placed at the console. See HFLM-10K Manual Addendum I.
5	Main Power Lamp DS101, DS102, DS103	Indicates which transmitter has main power on.
6	Aural Alarm Switch S104, S105, S106	When placed in the on position will arm the Aural Alarm.

Table 3-1 Continued

OPERATING CONTROLS AND INDICATORS

Index No.	Control and Indicator	Function
7	Aural Alarm DS104, DS105, DS106	Will operate if armed, and High Voltage or Main Power is lost in the Transmitter.
8	AC Fuses F101, F102	Will light when A.C. is lost to T101 transformer.
9	"XMTR MON" Selector	Selects which Transmitter is to be monitored on the oscilloscope.
10	Recorder Switches S108, S109, S110	Switches on the recorders.
11	Recorder "CAL" Adjustment	Positions the recorders pointer.
12	Oscilloscope	See Appendix B
13	Recorders	See Appendix A

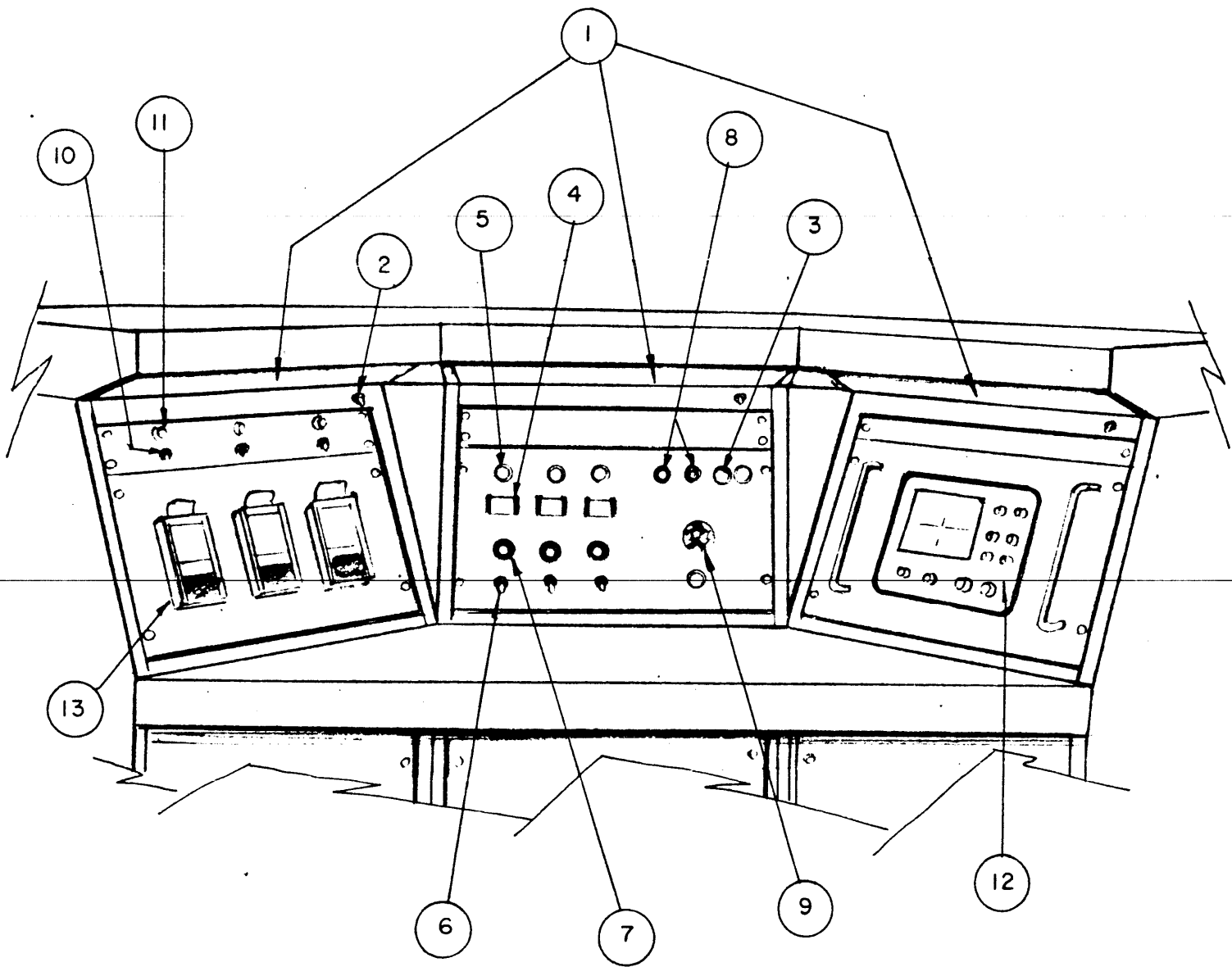

Figure 3-1
Controls and Indicators

Section 4

PRINCIPLES OF OPERATION

4-1. GENERAL

The control and monitoring of the Technical Materiel Corporations Model HFLM-10K Transmitters is made feasible with the incorporation of the console system, Model CON-(S).

The console provides control of High Voltage and Overload Reset, it will monitor transmitter Main Power, record ALDC Voltage, and monitor a sample of RF Output Power. An Aural Alarm will alert the console operator of the loss of Main Power and/or High Voltage.

4-2. RECORDER OPERATION - (Figure 4-1), Appendix A

The console has a built in +24 volt power supply, located in the center or control rack. The +24 volts lights a lamp marked "DC" on the control rack. This is a indication that AC is present at each recorder. If the recorder's switch, S108, S109 or S110 is switched ON the recorders will operate regardless of the status of the transmitter.

The operator must initiate the recorder start switch when he deems necessary. Thus if the DC Lamp is ON and the recorder's switch is initiated. AC will be present at Pin 3 and 4 of either P113, P112 or P111 and the recorder will operate.

The ALDC signal which is generated from the transmitter's ALDC Assembly A707 - Pin 2 is a negative voltage. (See HFLM-10K Manual). This negative voltage is transferred to a BNC Connector located at the transmitters interface. The voltage then must be routed to the rear panel of the center rack or control rack of the console. (See figure 1-2).

On the rear panel of the console, terminal boards TB101, TB102 and TB103 are typical input tie points for each transmitter. The ALDC signal is now placed at Pins 6 and 7 of the Terminal Boards, and is transferred to the recorder rack through J114 and on to each recorder connector P113, P112 and P111, before the negative signal passes on to the recorder connectors, it is interrupted by a potentiometer which is the recorder's pointer calibration adjustment.

S108, S109 and S110 will also switch in the required ALDC negative signal to the recorder.

4-3. OSCILLOSCOPE OPERATION - (Figure 4-1), Appendix B

The console is equipped with one oscilloscope and its operation depends solely upon verification of AC power. The oscilloscope is located on the right hand side of the console and has in its rear an AC connector strip which will supply power to the oscilloscope after insertion of the Oscilloscopes AC cord.

The center rack or control rack's operation panel has a selector switch marked "XMTR MON" 1, 2, 3 and 4. The operator can select any one of three transmitters to be monitored. The fourth position switches in to a connector marked "MON OUT" located below the selector switch. This affords the operator an extra monitoring position which can be used for an external monitoring operation.

With the transmitters tuned and generating RF Power and the selector switch in its proper position a sampling of the RF Output power is routed to the oscilloscope in the following manner. In the transmitter at A706-E2 a sample of RF is transferred to the transmitters interface. Each transmitters RF sampling signal is then routed to the rear panel of the center

rack or control rack of the console (see figure 1-1 and 1-2). J101, J102 and J103 will except each connection. These RF sampling signals are connected to S107 the RF Monitor Selection switch and depending on which position the switch is in routed to the oscilloscope input.

4-4. POWER DISTRIBUTION - (Figure 4-1)

An AC Line Input Connector is available at the bottom of the center rack or control rack. The AC Outlet is connected to three AC power strips, located at the rear of each rack. The control rack is outfitted with a line cord, that when connected will supply AC power to the recorders, florescent lamps, and supply +24 volts DC for the DC console power lamp and three Aural Alarms. F101 and F102 located at the control panel fuses the AC Lines. F103 fuses the +24 volt DC Line. See figure 3-1 and table 3-1 for fuse locations.

4-5. MAIN POWER INDICATION

Three Main Power "MAIN PWR" Lamps on the control panel reflect the status of Main Power at the transmitters. Each transmitter has a local/remote switch located at the transmitters main control panel adjacent to the HV ON switch. (HFLM-1K Addendum 1). When any one of the transmitters main power is ON and the local/remote switch is placed at remote the consoles main power lamp will light.

4-6. HIGH VOLTAGE CONTROL - (See Figure 4-1)

Addendum 1 of the HFLM-10K Manual explains how to delegate control of High Voltage to the console. When these conditions at the transmitter are completed, the operator will observe main power indication at the console. The High Voltage button (see figure 3-1) now must be depressed. A ground will enter at Terminal 1 of TB101, for clarity "XMTR-1" control will be detailed "XMTR-2" and "XMTR-3" have typical circuits. This ground

will illuminate the High Voltage button.

When the switch is activated a ground will return to the transmitter via TB101 terminal 3 and this ground will turn High Voltage ON in the transmitter.

4-7. AURAL ALARM

The Aural Alarm must be armed only after an Indication of Main Power and High Voltage is observed at the console. To arm the Alarm a switch located below each alarm must be turned ON.

Each Alarm is controlled by a Relay located in the rear panel of the control rack. Thus with Main Power ON +24vdc generated at the transmitter is placed on one side of the relay coil, with High Voltage ON a ground is placed on the opposite side of the relay coil. This will energize the relay. With the relay energized, +24vdc developed in the control rack is not allowed to operate the Aural Alarm. A lose of either High Voltage (GND) or Main Power (+24vdc) will deenergize the relay allowing +24vdc to operate the alarm.

4-8. OVERLOAD RESET - (HFLM-10K Addendum 1)

The overload reset circuitry is located in the interface Input Chassis Assembly of the transmitter. Addendum 1 of the HFLM-10K Manual explains in detail the overload resets circuits. When control of the transmitter is placed at the console (High Voltage Button and Main Power Lamp are illuminated) the transmitter experiences an overload, the High Voltage Indication will extinguish and the Aural Alarm will sound. At this point the operator must push the High Voltage button to OFF which will clear the overload reset circuit and push the button back to ON. We must then observe the High Voltage button for approximately fifteen seconds, if at that time the High Voltage light does not reappear

the overload problem must be attended to at the transmitter. When the High Voltage button is turned OFF a ground is transferred to Pin 19 of the overload reset printed circuit board, this will clear the circuit. Simultaneously +24 Volts is placed at pin 5 of the overload reset circuit. Pushing the High Voltage button back ON will remove the ground and transfer the +24 Volts to Pin 3. This will initiate the overload reset operation. See HFLM-10K Addendum 1 for detailed circuit operation.

To disable the overload reset circuit a switch is available at the transmitter input chassis. Opening the switch will remove +24 Volt from the overload reset circuit. Thus disabling the circuit.

Control for resetting the transmitter without the overload reset circuit is performed as stated above. Turn High Voltage OFF and then back ON. If after doing this two or three times the High Voltage button does not light the operator must attend to the overload condition at the transmitter site.

D

C

B

XMTR-1
MAIN PWR

DS101

J118
P118

S101

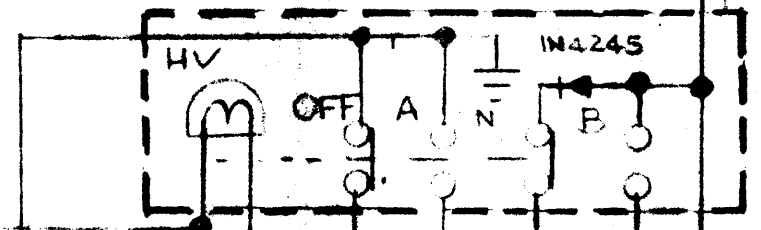
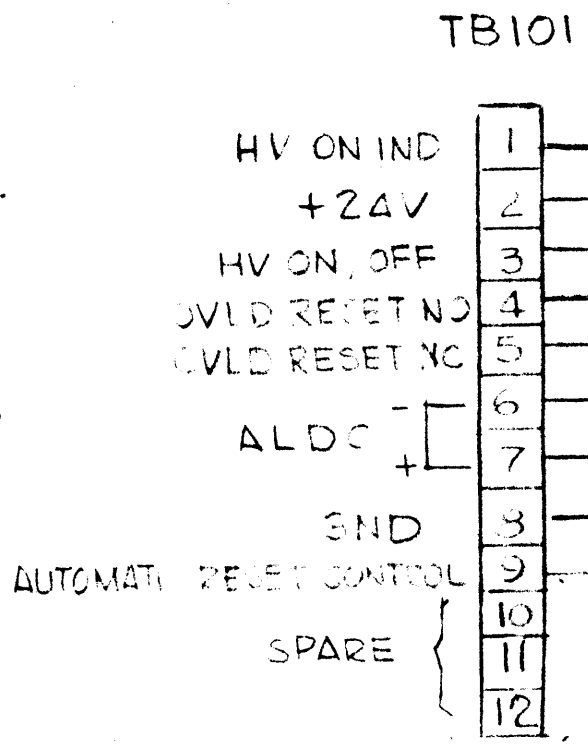

K101

XMTR-2
MAIN PWR

DS102

S102

K102

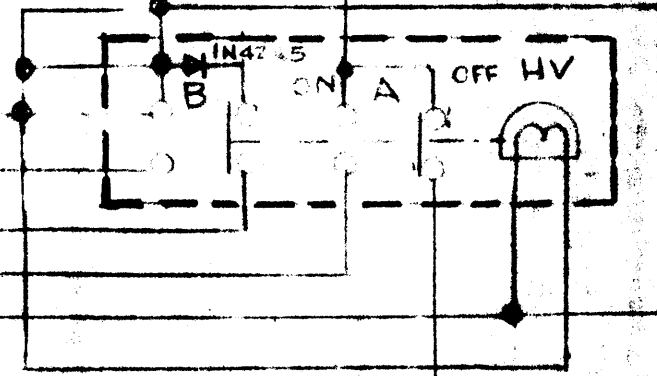
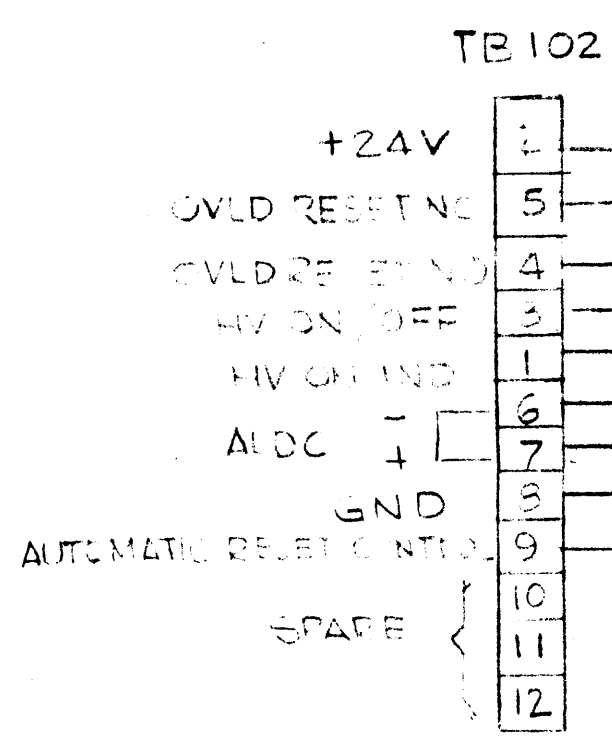

XMTR-3
MAIN PWR

DS103

S103

K103

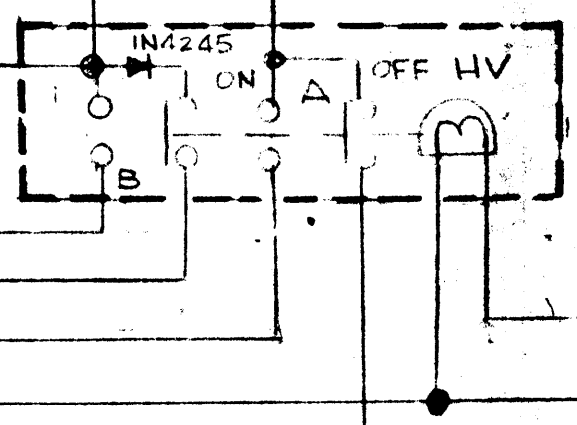
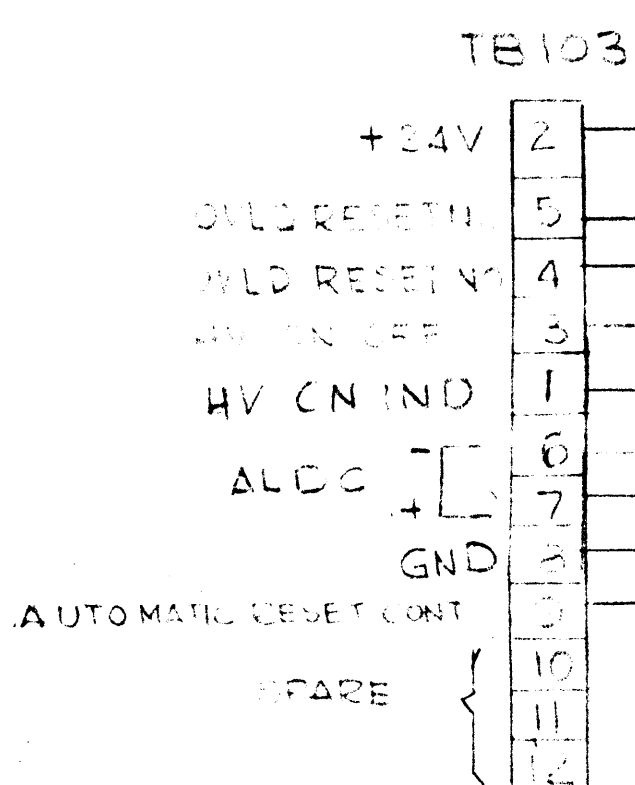

DS104
ALARM 3

DS105
ALARM 2

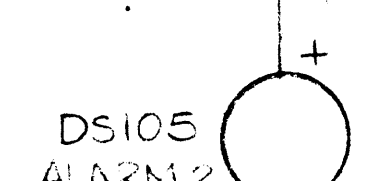
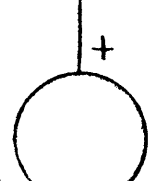

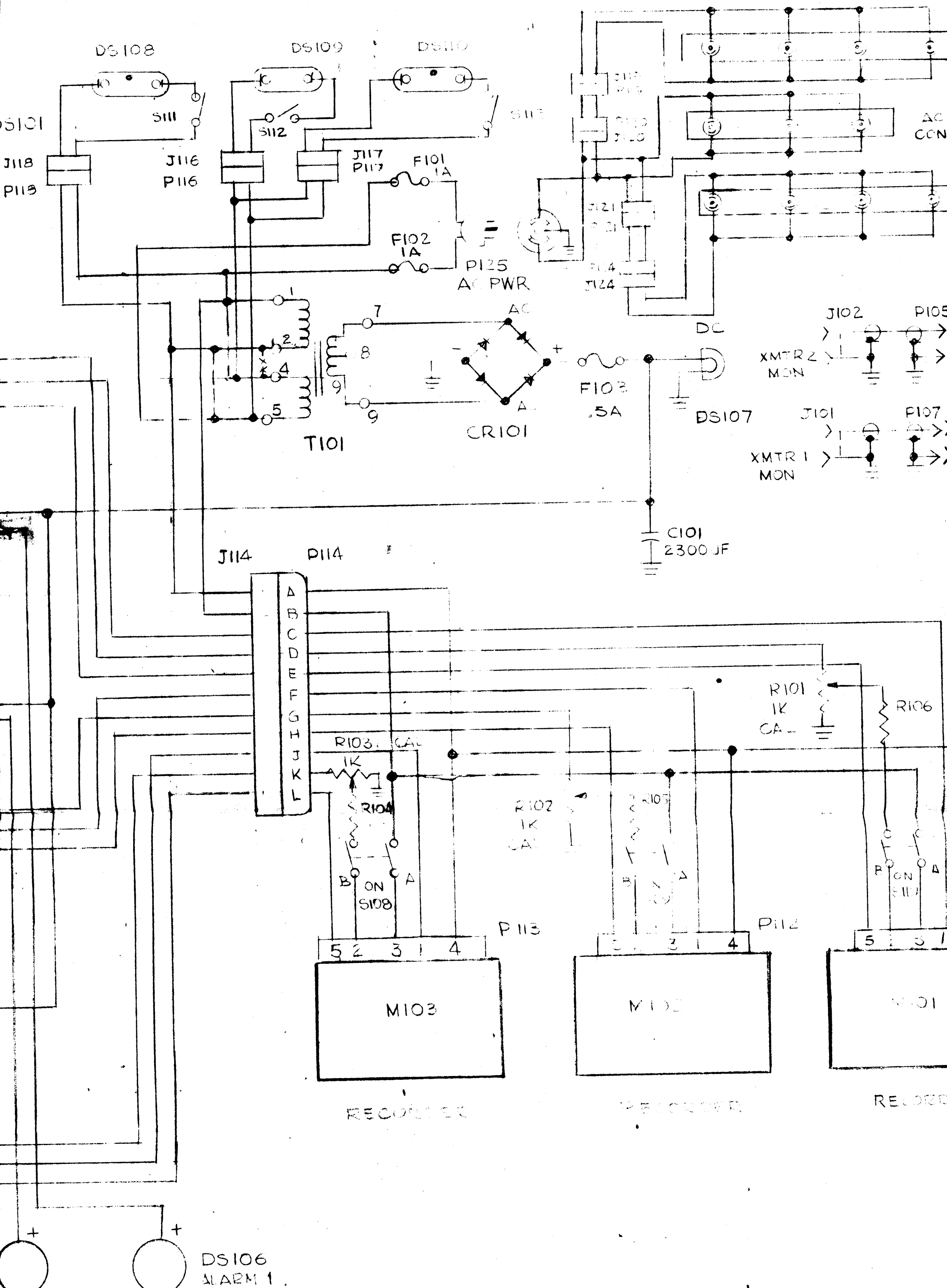

					REVISIONS		
E.M.N.NO	DRAFT	CHKD	ZONE	LTR	DESCRIPTION	DATE	APPROVED

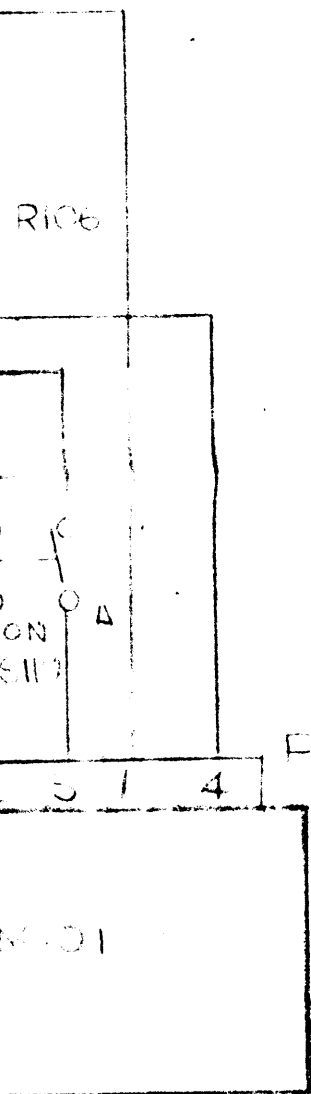
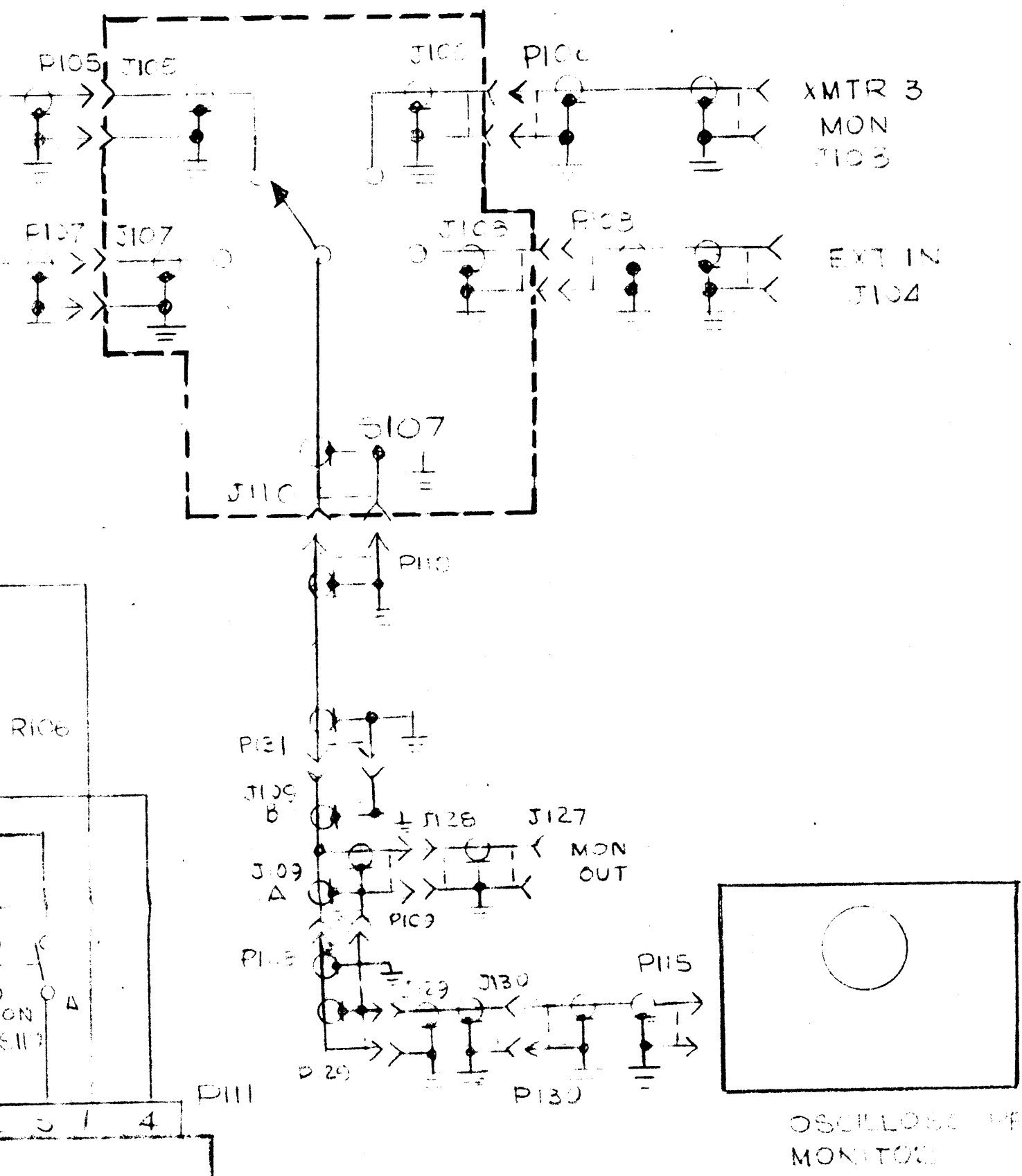
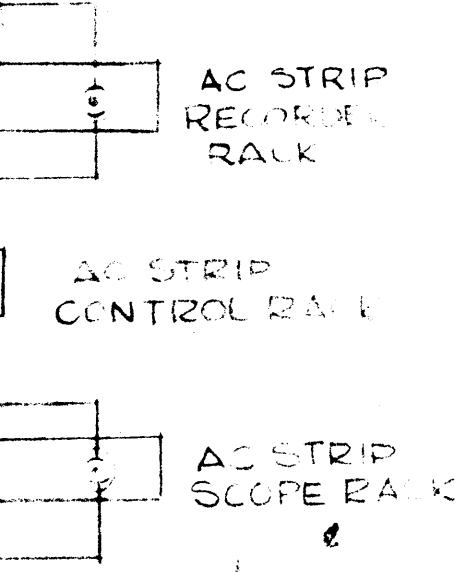

NOTE:

TICK CONNECTIONS FOR NEW OPERATION
 DISCONNECT JUMPER MARKED —X—
 FROM TERMINALS AND RECONNECT
 JUMPERS MARKED — — — TO TERMINALS

D

C

B

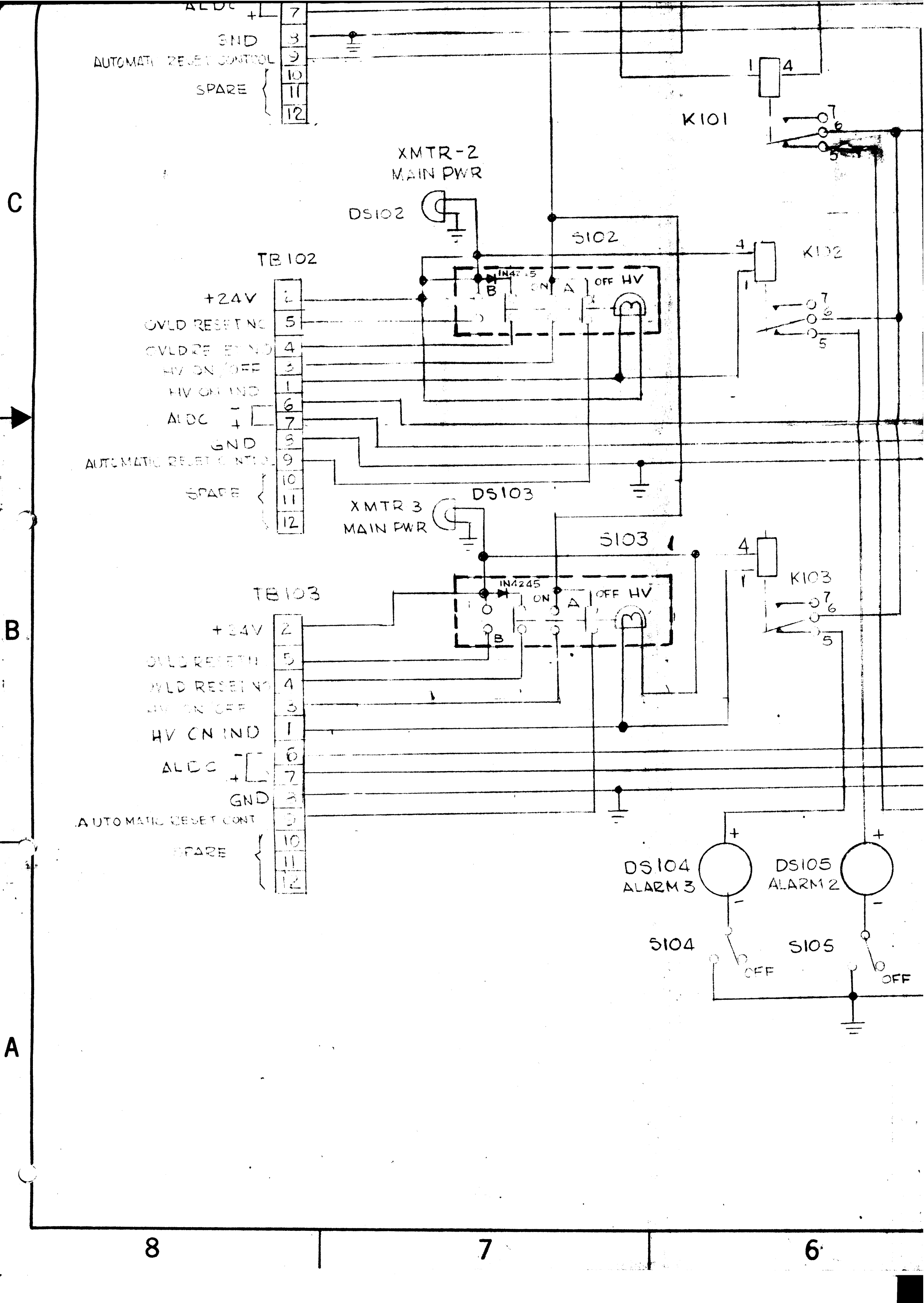

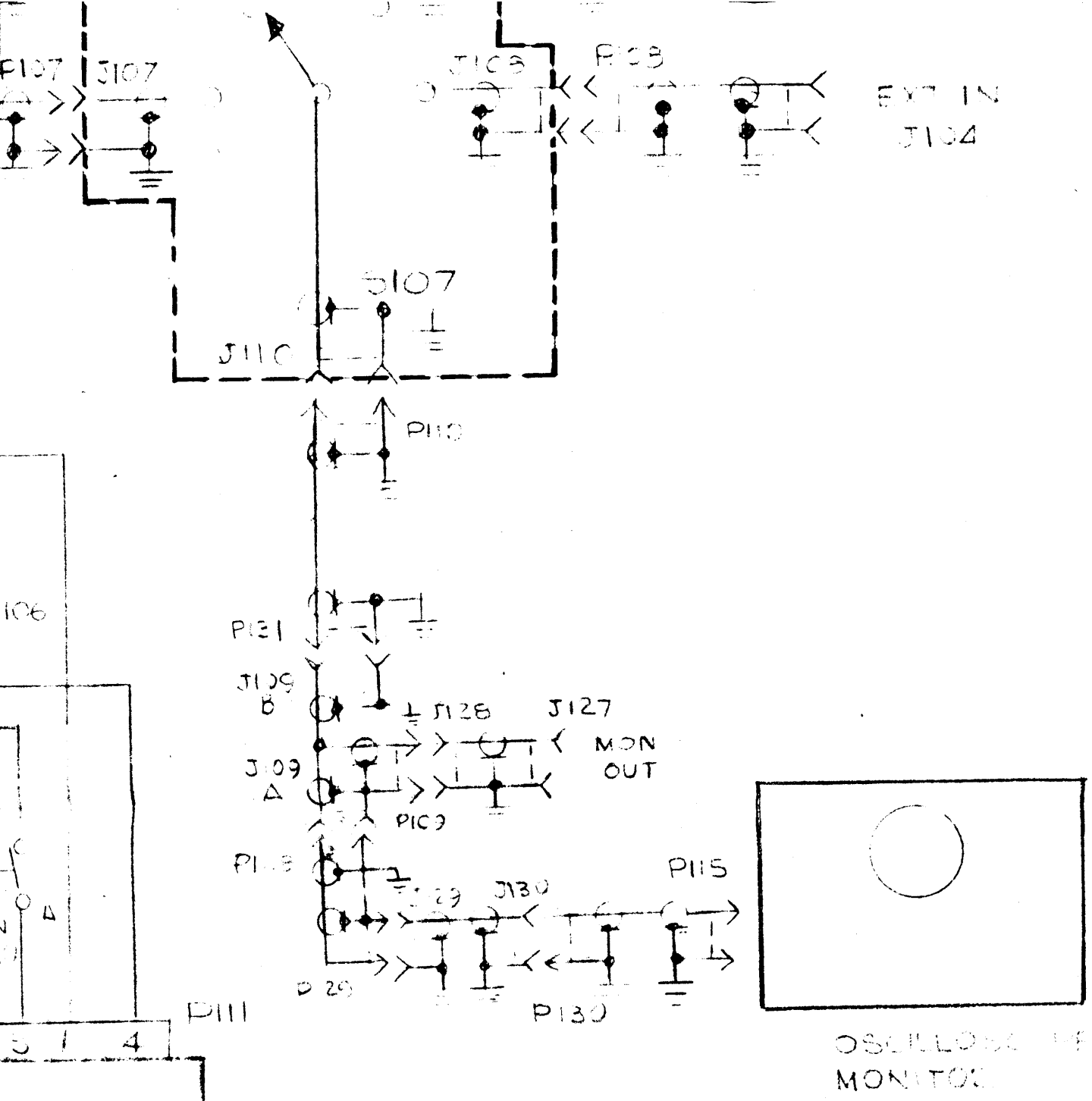

OSCILLOSCOPE MONITOR

NOTE:
 TYPICAL CONNECTIONS FOR NEW OPERATIONS
 DISCONNECT JUMPER MARKED —X—
 FROM TERMINALS AND RECONNECT
 JUMPERS MARKED — — — TO TERMINALS

C

B

A

UNLESS OTHERWISE SPECIFIED DIMENSIONS ARE IN INCHES AND INCLUDE CHEMICALLY APPLIED OR PLATED FINISHES	
TOLERANCES ON	
DECIMALS	FRACTIONS
.X ± .05	± 1/64
.XX ± .01	ANGLES
.XXX ± .005	± 0° -30'
MATERIAL	
FINISH	

Figure 4-1. Schematic Diagram Overall Console

SECTION 5
MAINTENANCE

5-1. GENERAL INFORMATION

Care in the operation of the Control Console CON-(S), will enhance the reliability built into the system and contribute to long periods of trouble-free service. The system operates at a low power level and component stress is minimal in normal operation. Daily care should be provided to prevent the accumulation of dust and dirt and eliminate any grease or grime which might degrade equipment appearance or performance.

5-2. PREVENTIVE MAINTENANCE

Those actions which are taken on a regularly scheduled basis to reduce to a minimum the loss of equipment availability due to failure may be considered preventive maintenance. In this category are such procedures as cleaning, inspection and minor repair.

a. Cleaning. The external surfaces of the units should be free of contamination at all times. Greasy substances may be removed with any good dry cleaning solvent, but adequate ventilation must be provided.

The internal components should be cleaned on a weekly basis during the regular inspection. Dust may be removed from terminals with a soft brush or low pressure (under 20 psi) compressed air.

b. Inspection. A thorough visual inspection conducted at least weekly is recommended as a practical means of preventing trouble before it occurs. All of the components and wiring should be examined for evidence of deterioration. Connections and terminal boards should be checked for security. If corrosion, charring, discoloration or grease is evident, the condition should be corrected by cleaning or replacing the component. Any loose connectors or connections should be tightened.

Broken, cracked or frayed wiring should be replaced.

c. Minor Repair. Repair procedures which do not make extensive testing mandatory, may be considered minor. Replacing defective components on the modular level is an example of such a procedure, as is tightening loose electrical or mechanical connections. When replacing any component, only the same or electrically equivalent parts should be used. Section 6 of this manual presents a list of components by part number and should be consulted when repairs are being made.

5-3. CORRECTIVE MAINTENANCE

In the event of a major malfunction, standard trouble shooting techniques should enable a competent technician to locate the problem, determine the cause, and take the necessary corrective action. No special tools are required to service the console. A standard volt/ohm meter such as a Simpson, Model 260, will be found useful.

SECTION 6
PARTS LIST

The parts lists presented in this section provide a cross reference between the reference designation of the part and the TMC part number. The reference designation is used to identify a part on assembly drawings and schematic diagrams. Wherever practical, they are also marked on the equipment adjacent to the part.

The letter of the reference designator identifies the generic group to which the part belongs: e.g., resistor (R), capacitor (C), switch (S).

Complete identification will expedite delivery when ordering renewal parts. The following information should be given for each part:

Description
*Reference designation
TMC part number
*Assembly number
Equipment model number
Equipment serial number

This information is available from the equipment nameplate, and the parts lists in this section.

To simplify the task of ordering renewal parts, an order form has been included at the end of this section. The information requested in the preceding list which has been marked with an asterisk should be included in the description column.

Part Number	Description	Used On	Qty	Symbol Number
A	Florescent Lamp Ass'y. w/switch	CON-(S)	3	DS108, DS109, DS110
BI110-7	Lamp,	CON-(S)	4	DS101, DS102, DS103, DS107
BZ101-2	Aural Alarm	CON-(S)	3	DS104, DS105, DS106
CE119-2300-50	Cap. Electrolytic	CON-(S)	1	C101
DD146-9	Rectifier Diode	CON-(S)	1	CR101
FH104-3	Fuse Holder AC	CON-(S)	2	XF101, XF102
FH100-1	Fuse Holder DC	CON-(S)	1	XF103
FU102-1	Fuse	CON-(S)	1	F101, F102
FU102-.5	Fuse	CON-(S)	1	F103
RL156-1	Relay, Arm	CON-(S)	3	K101, K102, K103
ST22K	Switch, Toggle	CON-(S)	3	S108, S109, S110
ST103-6-62	Switch, Toggle	CON-(S)	3	S104, S105, S106
SW239	Switch, 4 Post.	CON-(S)	1	S107
SW522-1	Switch, HV	CON-(S)	3	S101, S102, S103
TF441	Transformer	CON-(S)	1	T101
TM105-12AL	Fanning Strip	CON-(S)	3	XTB101, XTB102, XTB103
TM100-12	Barrier Strip	CON-(S)	3	TB101, TB102, TB103
TS153-5	Socket, Lamp	CON-(S)	1	XDS107
TS171-1	Socket, Relay	CON-(S)	3	XK101, XK102, XK103
TS153-2	Socket, Lamp	CON-(S)	3	XDS101, XDS102, XDS103
UG625/U	BNC Conn.	CON-(S)	4	J105, J106, J107, J108