

REVISIONS						
ZONE	SYM	DESCRIPTION	DATE	E.M.N. NO.	DRAFT	CHKD
		ORIGINAL RELEASE FOR PRODUCTION	8/1/65			

TOP OF PANEL

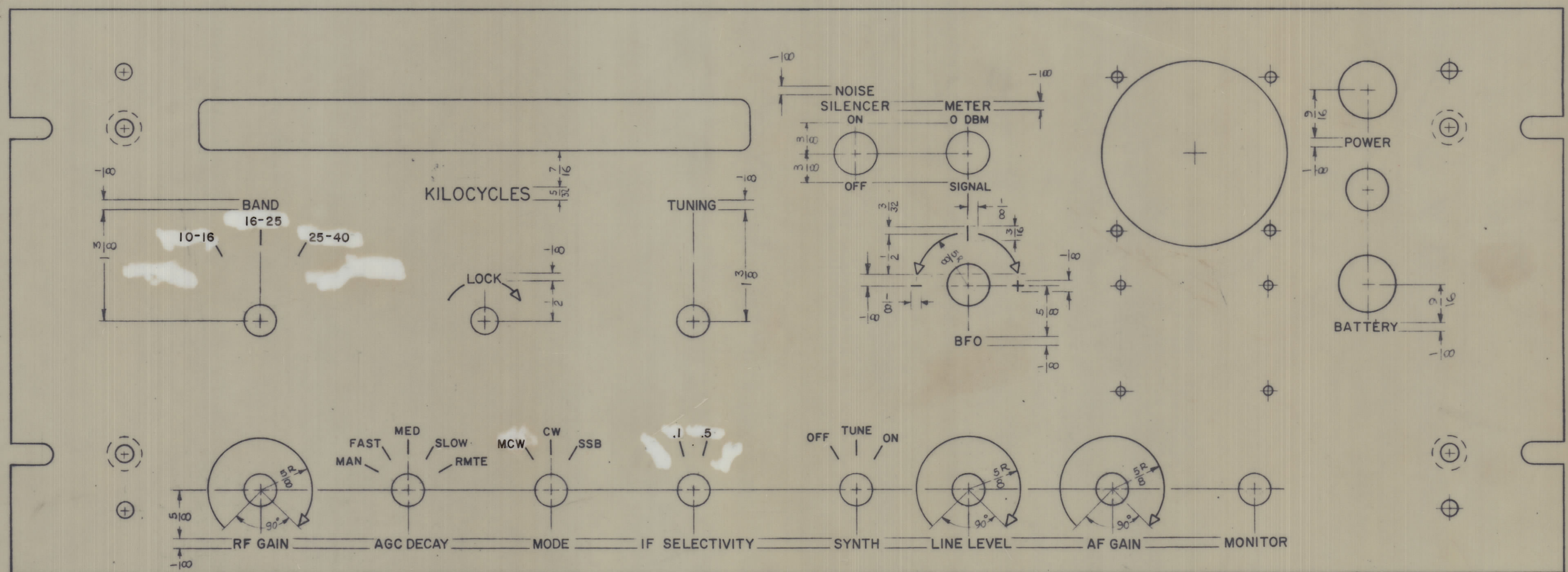

HEIGHT OF LETTERS	DEPTH OF STROKE	WIDTH OF STROKE
3/32	.010	.015
1/8	.010	.020
5/32	.010	.020
LINES	.010	.015
ARROWHEADS	.010	.015

SEE DETAIL

- ~UNLESS OTHERWISE SPECIFIED~
- 1-ALL ENGRAVING TO BE 3/32 HIGH, WHITE FILLED.
 - 2-ALL LINES TO BE WHITE FILLED.
 - 3-ARROWHEADS TO BE WHITE OUTLINE FILLED.
 - 4-1/16 SPACING BETWEEN ALL LETTER GROUPS.
 - 5-ALL LETTER GROUPS TO BE CENTERED ON HOLES OR SLOTS.

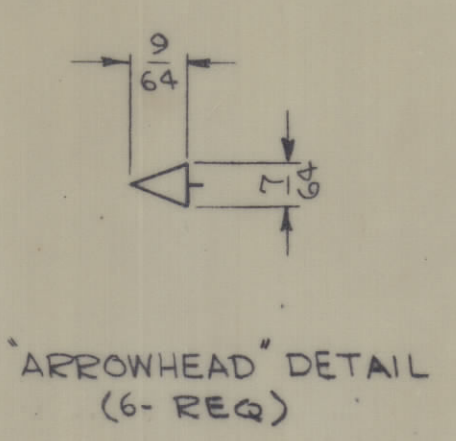
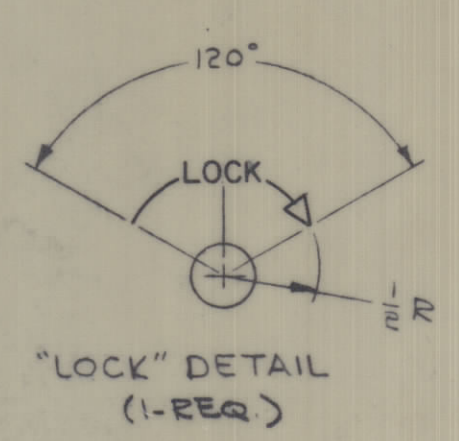
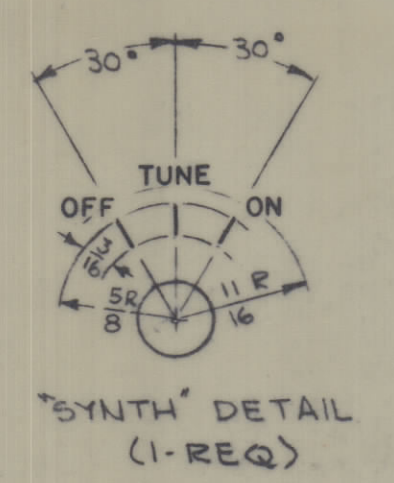
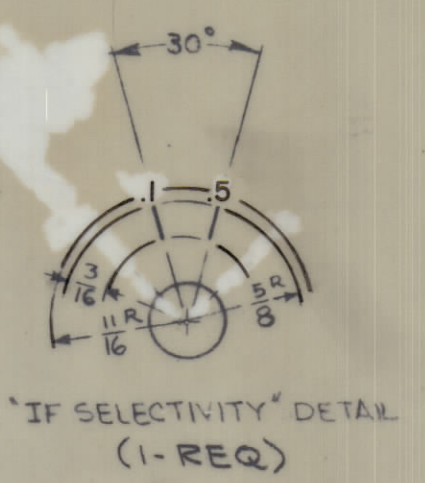
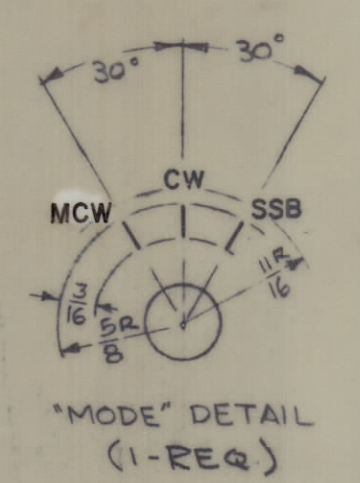
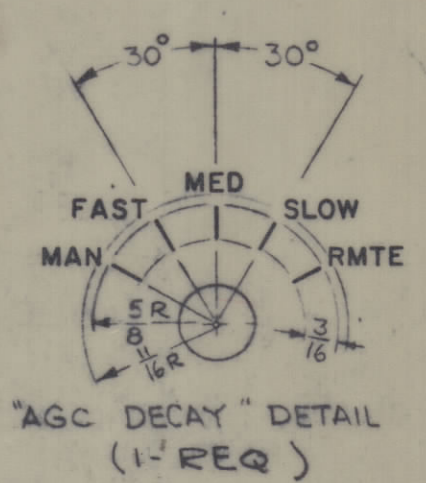
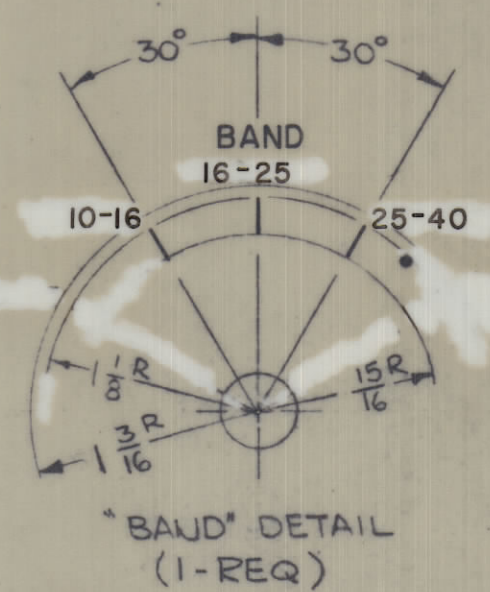

REF: M53960

REQ'D.	ITEM	PART NUMBER	DESCRIPTION	SYMBOL
			LIST OF MATERIAL	SK3136-LD-2
			THE TECHNICAL MATERIEL CORP.	
			MAMARONECK, NEW YORK	
			TITLE	MARKING, PANEL, FRONT
			MARKING PROCESS-ENGRAVING	
			UNLESS OTHERWISE SPECIFIED DIMENSIONS ARE IN INCHES AND INCLUDE CHEMICALLY APPLIED OR PLATED FINISHES	
			DECIMALS ±.001	
			FRACTIONS ±.001	
			TOLERANCES ±.001	
			ANGLES ±.001	

QTY	UNIT	MODEL USED ON	ASSY. NO.
1		VLRC-1	
		SCALE	
		1:1	
		CODE	
		A	

NOTES

THE CONTENTS OF THIS DRAWING ARE THE EXCLUSIVE PROPERTY OF THE TECHNICAL MATERIEL CORP. ITS UNAUTHORIZED USE OR REPRODUCTION IN WHOLE OR IN PART IS STRICTLY FORBIDDEN.

LD1980

ZONE		SYM	DESCRIPTION	DATE	E.M.N. NO.	DRAFT	CHKD	APPD
0			ORIGINAL RELEASE FOR PRODUCTION	8/19/65				

REAR VIEW SHOWN

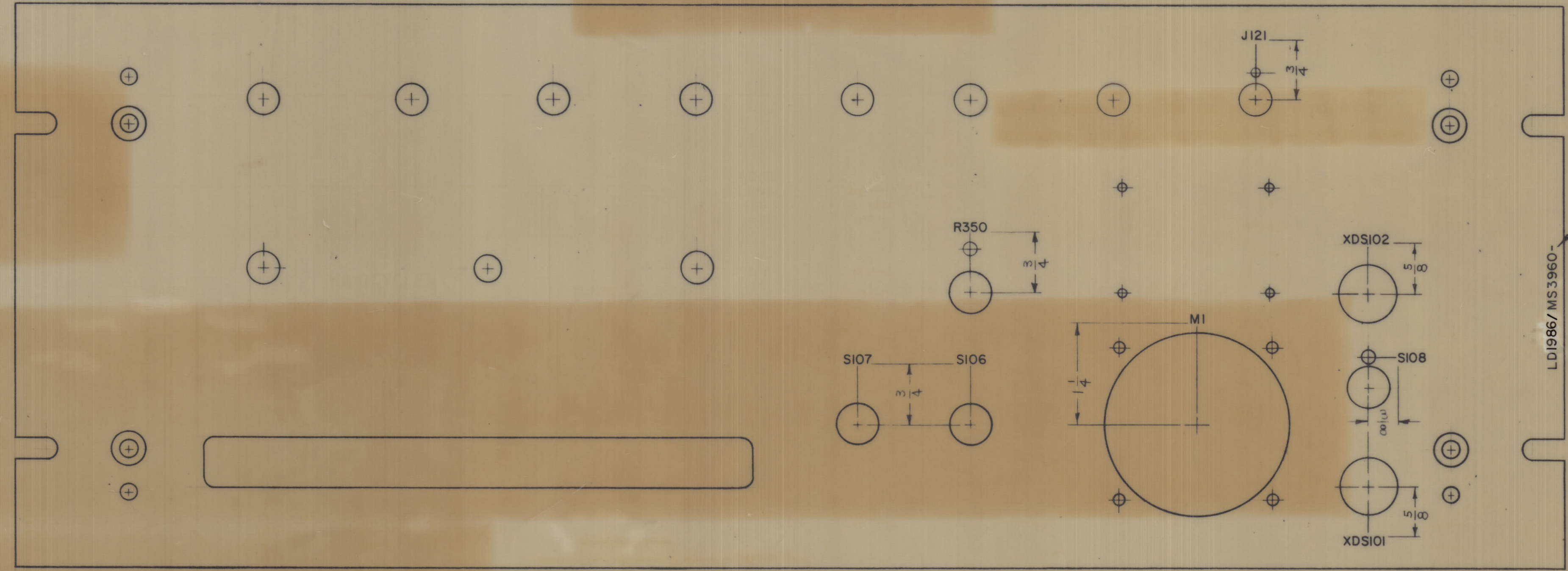

MARK TMC PART NO. 1/8 HIGH BLACK GOTHIC, WITH LATEST REV. LETTER.

LD1986/MS3960

TOP OF PANEL

MARKING PROCESS: AS PER TMC SPECIFICATION S-727.
 LETTERING: 1/8 HIGH BLACK GOTHIC, LOCATED AS SHOWN.

REF: MS3960

1	VLRC-1	
QTY/UNIT	MODEL USED ON	ASSY. NO.
SCALE	CODE	
1:1	A	

REQ'D.	ITEM	PART NUMBER	DESCRIPTION	SYMBOL
			LIST OF MATERIAL	SK3136-LD-2
			THE TECHNICAL MATERIEL CORP.	
			MAMARONECK, NEW YORK	
			TITLE	
			MARKING, PANEL, FRONT	
			MARKING PROCESS: PER TMC SPEC S-727	
			UNLESS OTHERWISE SPECIFIED DIMENSIONS ARE IN INCHES AND INCLUDE CHEMICALLY APPLIED OR PLATED FINISHES	
			DRAWN	DATE
			CHECKED	DATE
			ELECT. DES	DATE
			MECH. DES	DATE
			DATE	
			SHEET	

NOTES

THE CONTENTS OF THIS DRAWING ARE THE EXCLUSIVE PROPERTY OF THE TECHNICAL MATERIEL CORP. ITS UNAUTHORIZED USE OR REPRODUCTION IN WHOLE OR IN PART IS STRICTLY FORBIDDEN.

DECIMALS: .XX ± .05, .XXX ± .008
 FRACTIONS: ± 1/64
 ANGLES: ± 6° 30'

LD1986