

REVISIONS					
E.M.N.NO	DRAFT	CHKD	ZONE	LTR	
	CL			Ø	
DESCRIPTION				DATE	APPROVED
ORIGINAL RELEASE FOR PRODUCTION				3/23/73	

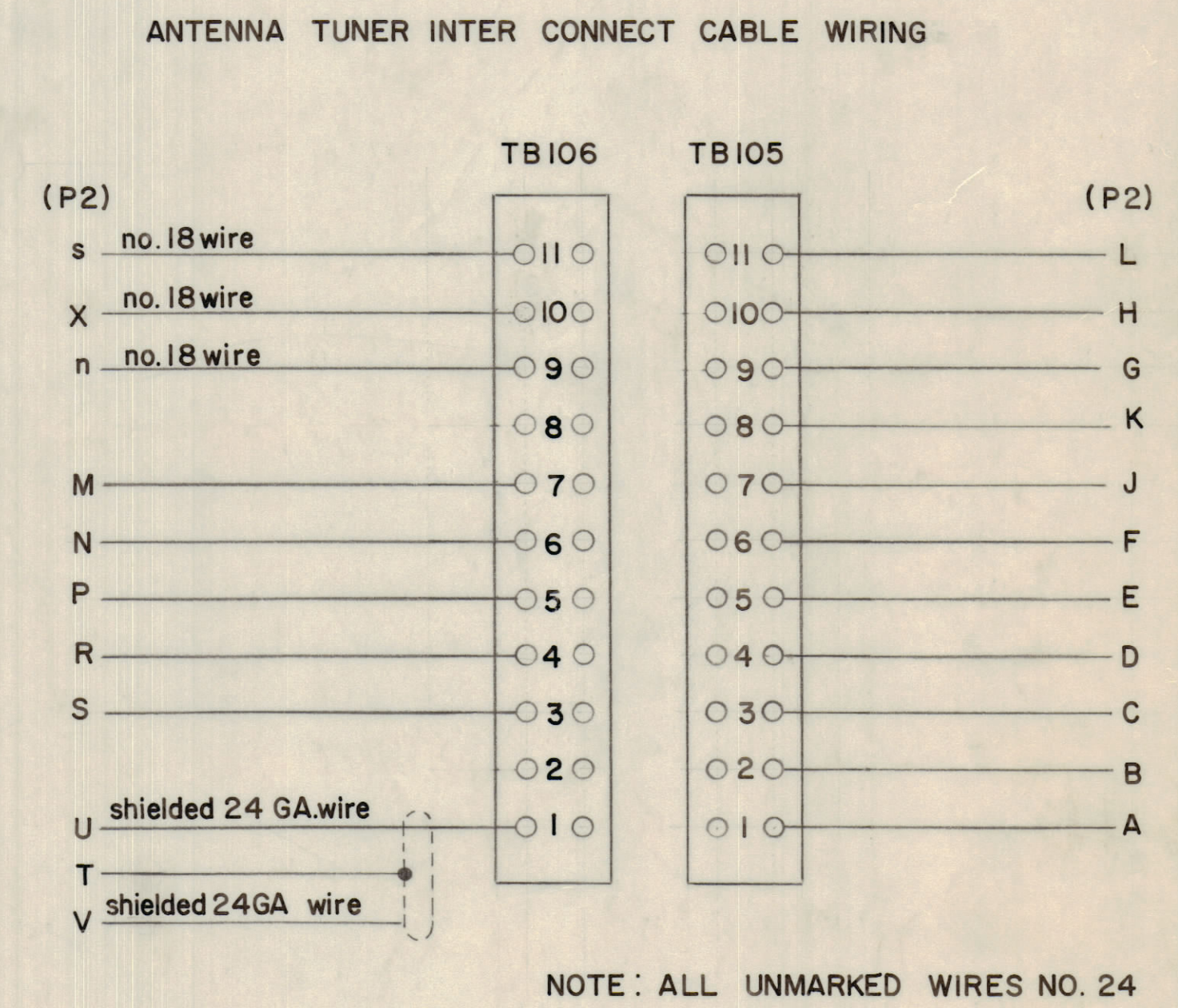
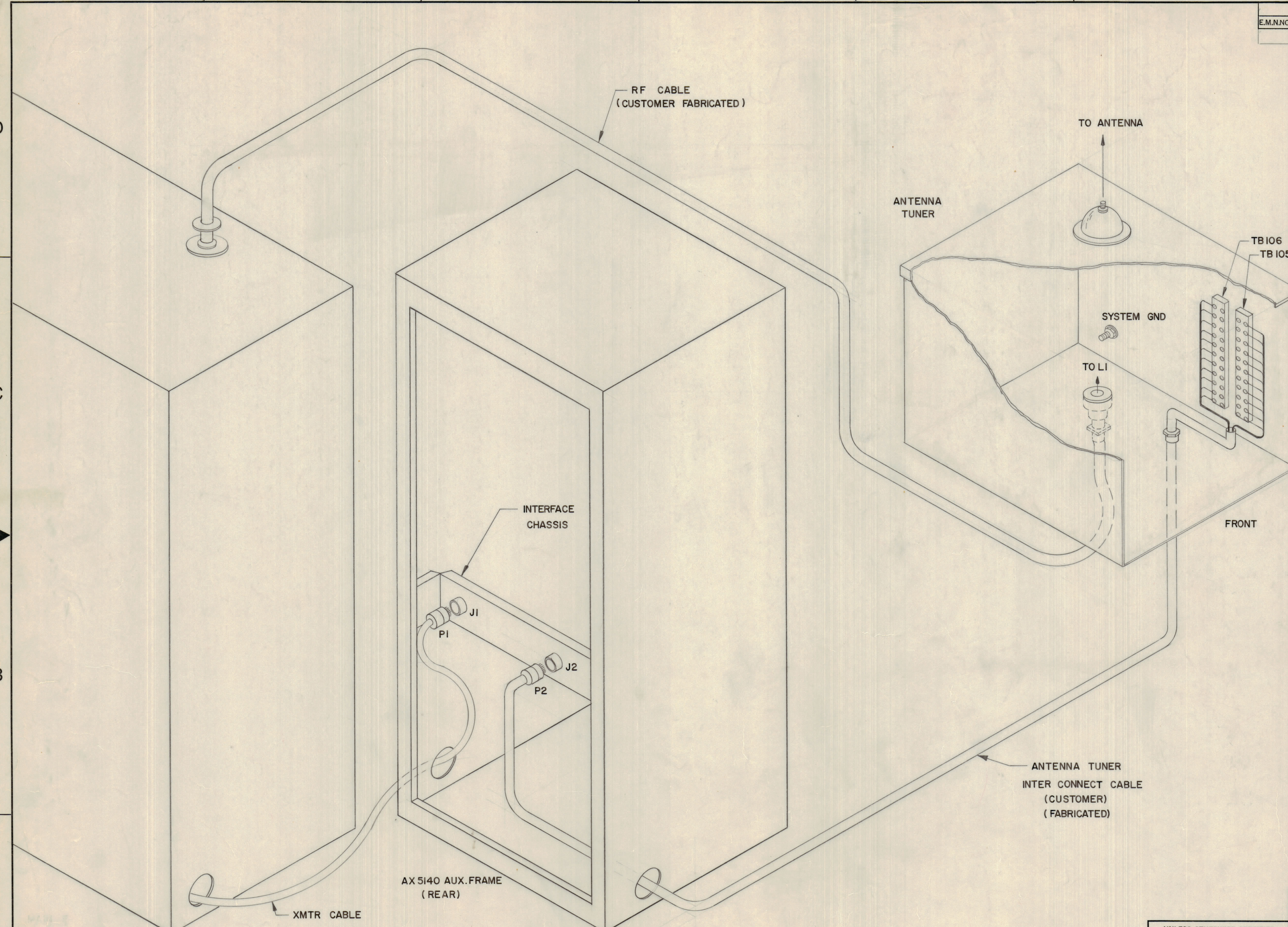

MFRIOKE		
QTY / UNIT	MODEL USED ON	ASS'Y NO.
APPLICATION		
CODE		
<small>NOTICE TO PERSONS RECEIVING THIS DRAWING</small> <small>THE TECHNICAL MATERIEL CORPORATION claims proprietary right in the material disclosed herein. This drawing is issued in confidence for engineering information only and may not be reproduced or used to manufacture anything shown herein without permission from THE TECHNICAL MATERIEL CORPORATION to the user. This drawing is loaned for mutual assistance and is subject to recall at any time.</small>		

QTY. REQ.	ITEM	PART NO.	DESCRIPTION	SYMBOL
LIST OF MATERIAL				
FINAL APPROVAL		DATE	THE TECHNICAL MATERIEL CORP.	
MECH. DES.		DATE	MAMARONECK, NEW YORK	
ELECT. DES.		DATE	INSTALLATION DIAGRAM	
CHECKED		DATE	ANTENNA TUNER HOOKUP	
DRAWN		DATE	SIZE CODE IDENT NO. DWG NO.	
G. EVANGELIST		12/21/71	D 82679	ID 402
MATERIAL		SCALE		ISSUE
FINISH		SHEET 1 OF 4		Ø

REVISIONS							
E.M.N.O	DRAFT	CHKD	ZONE	LTR	DESCRIPTION	DATE	APPROVED
	Q			D	ORIGINAL RELEASE FOR PRODUCTION	3/28/80	

POLE MTG

TRENCH MTG

NOTE: FOR OUTSIDE INSTALLATION
THE TUNING UNIT SHOULD BE
ENCLOSED IN A WEATHERPROOF
SHELTER

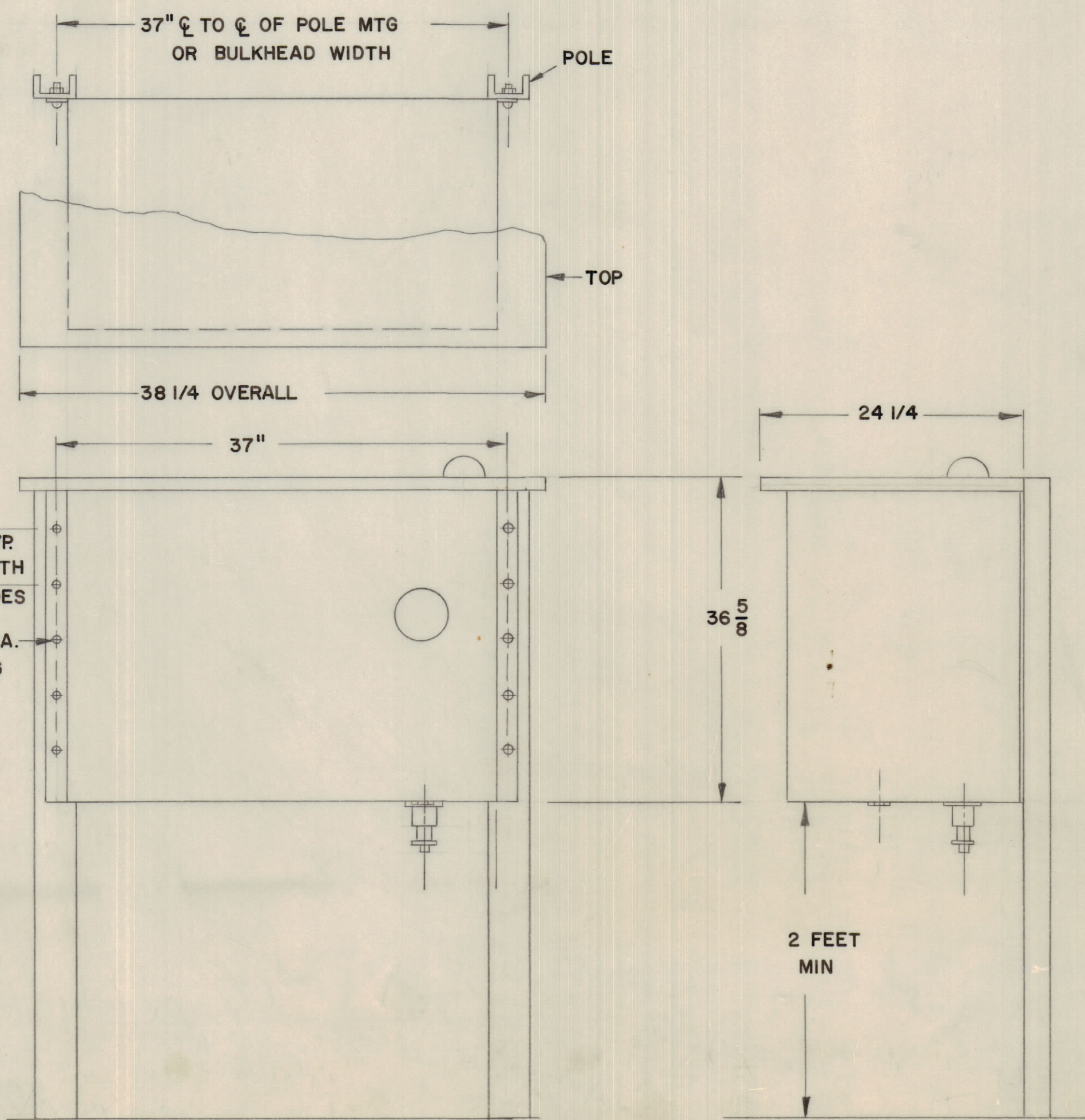
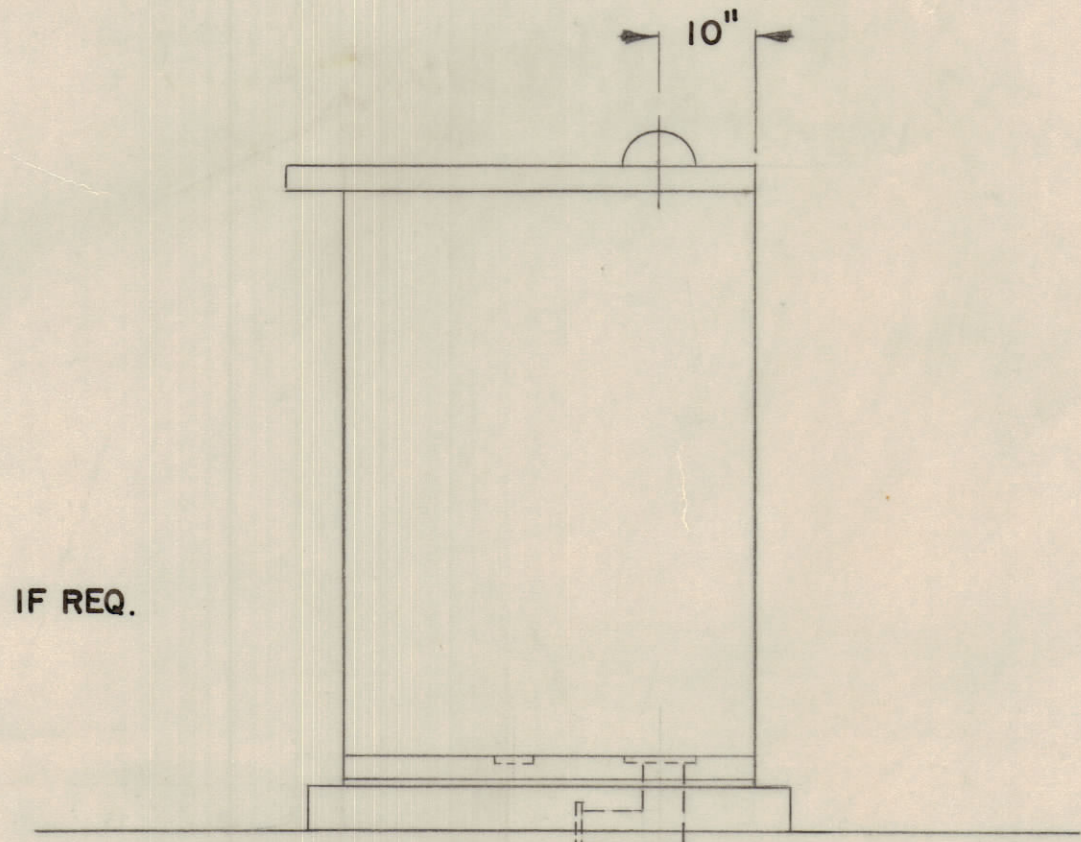
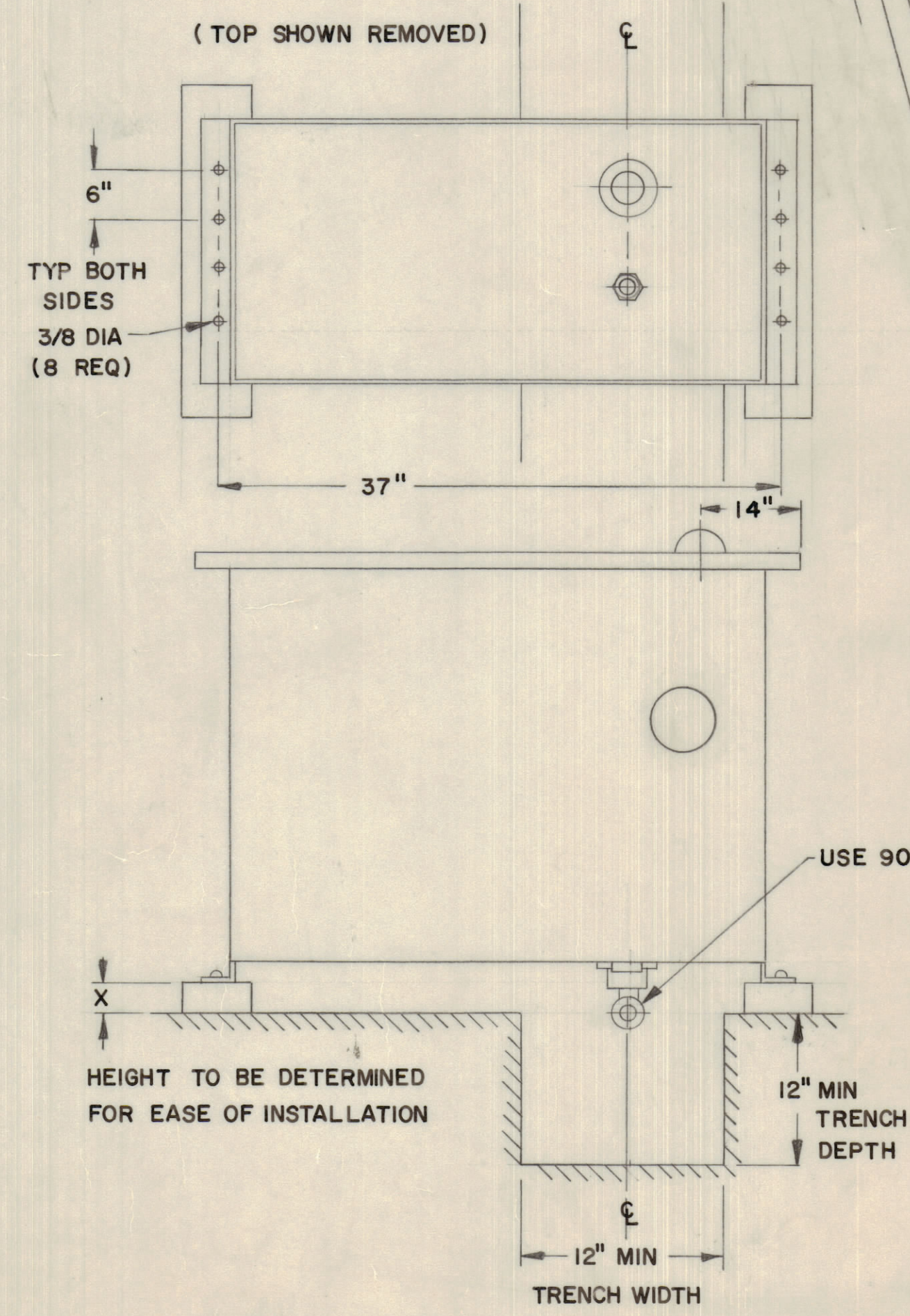
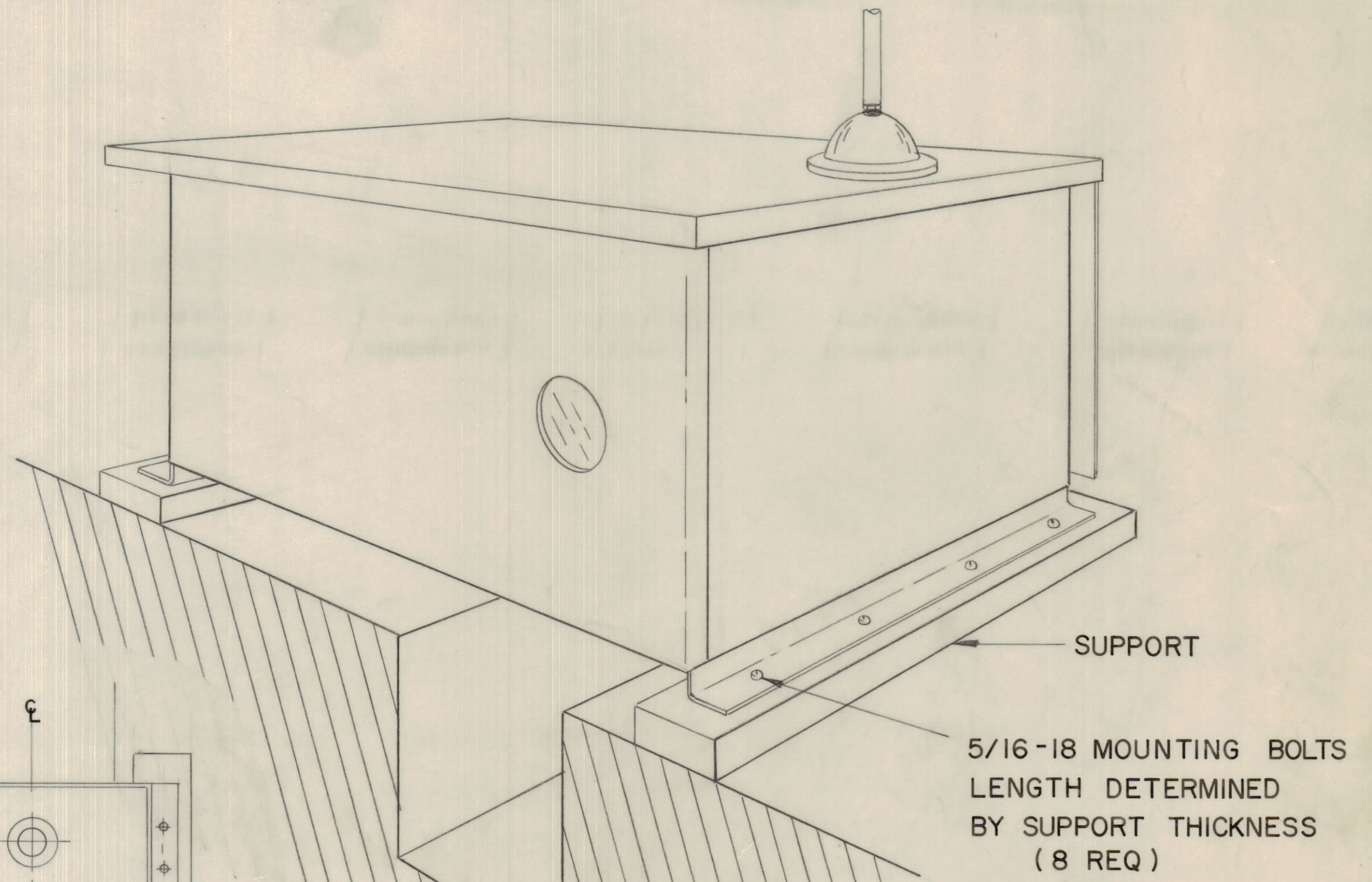
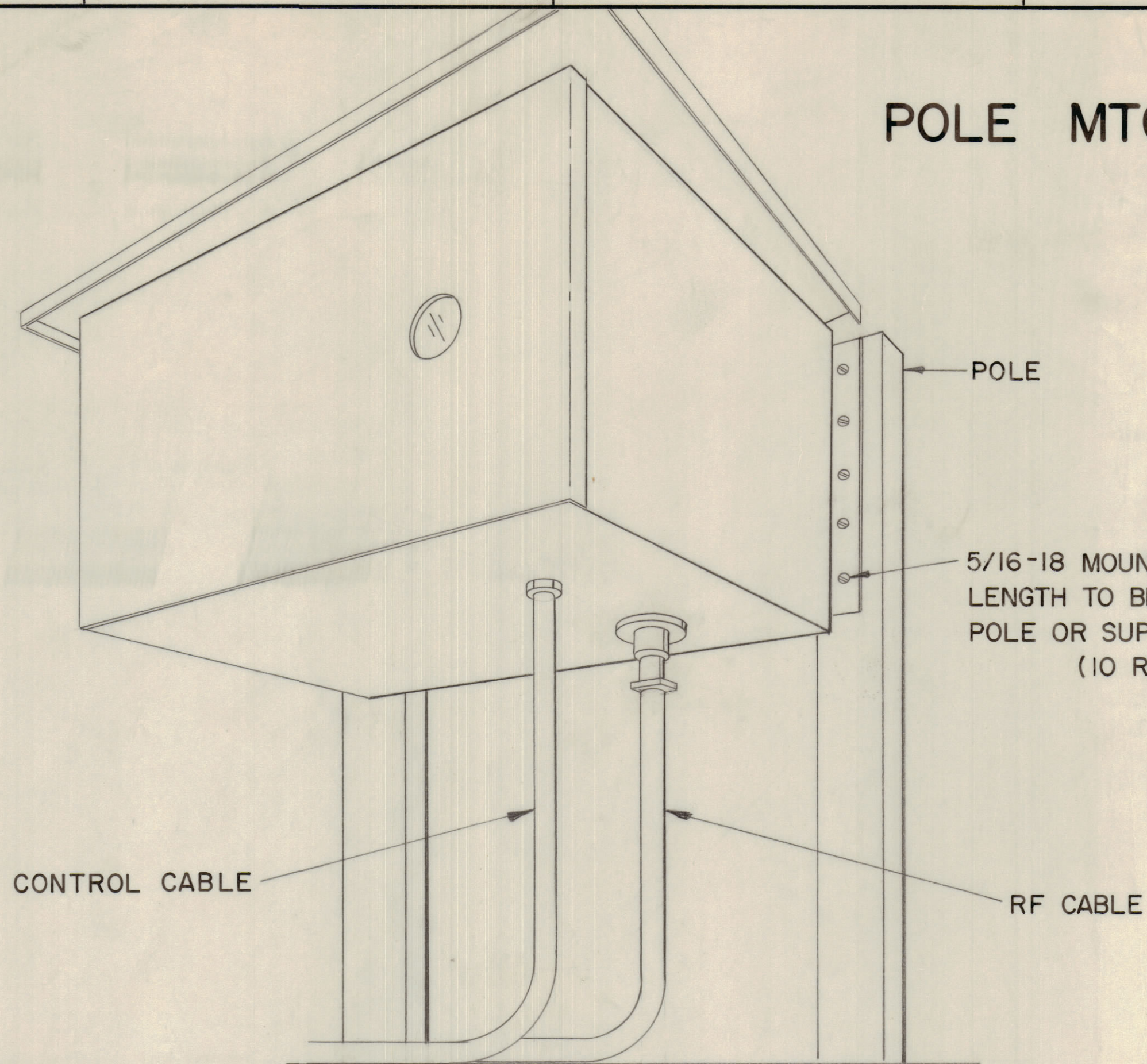

QTY / UNIT	MODEL USED ON	ASS'Y NO.
APPLICATION		
CODE		
MATERIAL		
FINISH		

UNLESS OTHERWISE SPECIFIED DIMENSIONS ARE IN INCHES AND INCLUDE CHEMICALLY APPLIED OR PLATED FINISHES

TOLERANCES ON
 DECIMALS FRACTIONS
 .X ± .05 ± 1/64
 .XX ± .01 ± .001
 .XXX ± .005 ± 0° -30'

QTY. REQ.	ITEM	PART NO.	DESCRIPTION	SYMBOL
LIST OF MATERIAL				
FINAL APPROVAL		DATE	THE TECHNICAL MATERIEL CORP.	
MECH. DES.		DATE	MAMARONECK, NEW YORK	
ELECT. DES.		DATE	INSTALLATION DIAGRAM	
CHECKED		DATE	ANTENNA TUNER	
DRAWN		DATE	SIZE CODE IDENT NO. DWG NO.	
MATERIAL		D 82679		ID 402
FINISH		SCALE		SHEET 2 OF 4

NOTICE TO PERSONS RECEIVING THIS DRAWING
 THE TECHNICAL MATERIEL CORPORATION claims proprietary right in the material disclosed hereon. This drawing is issued in confidence for engineering information only and may not be reproduced or used to manufacture anything shown hereon without permission from THE TECHNICAL MATERIEL CORPORATION to the user. This drawing is loaned for mutual assistance and is subject to recall at any time.

REVISIONS							
E.M.N.NO	DRAFT	CHKD	ZONE	LTR	DESCRIPTION	DATE	APPROVED
	CL				ORIGINAL RELEASE FOR PRODUCTION	3/28/73	

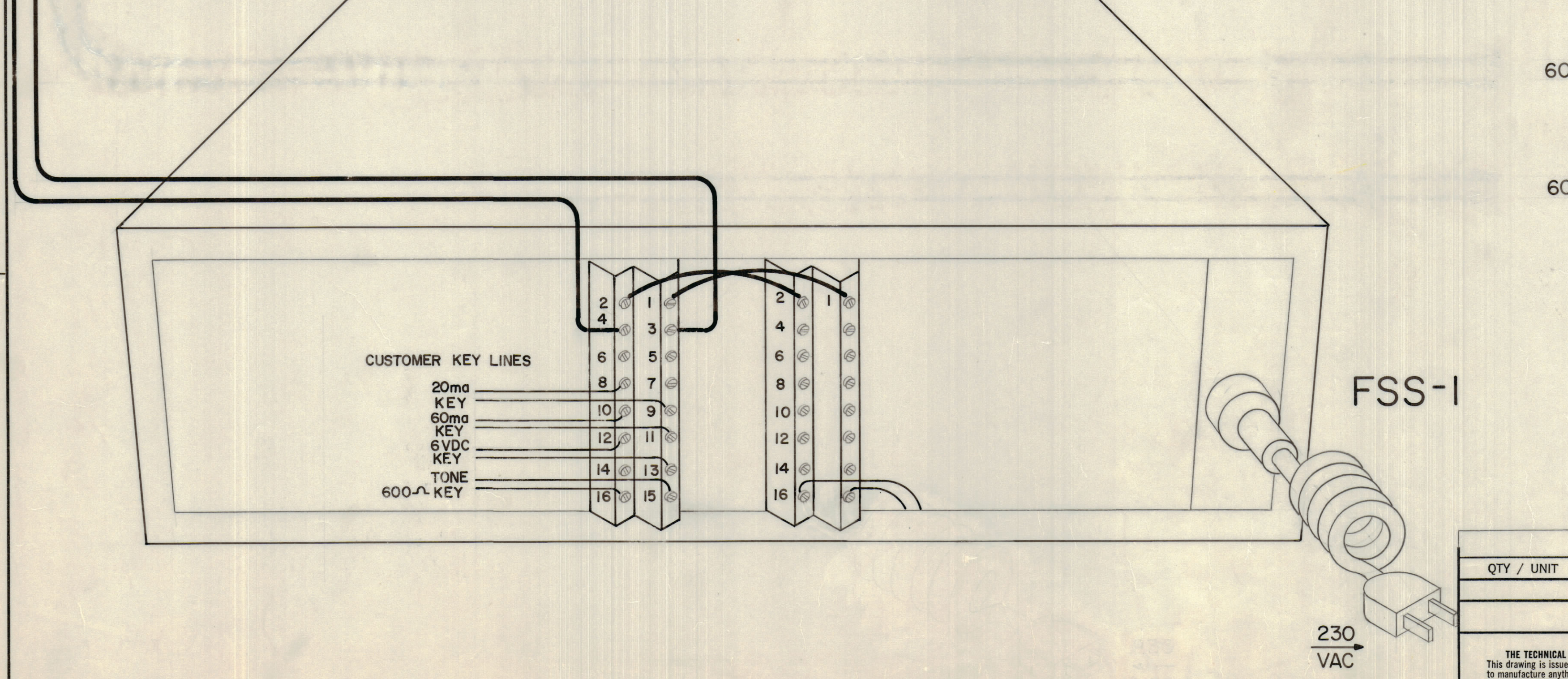
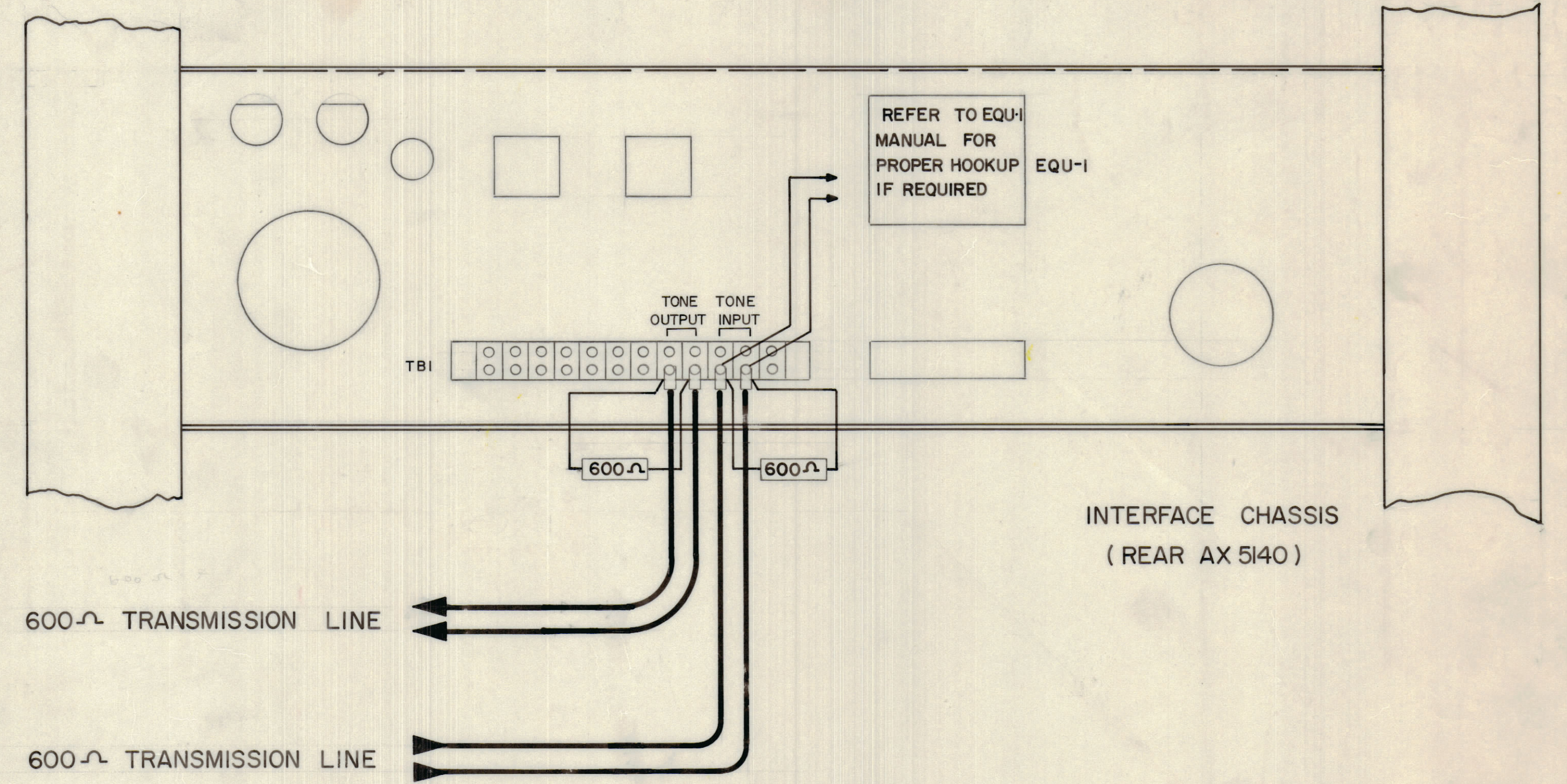
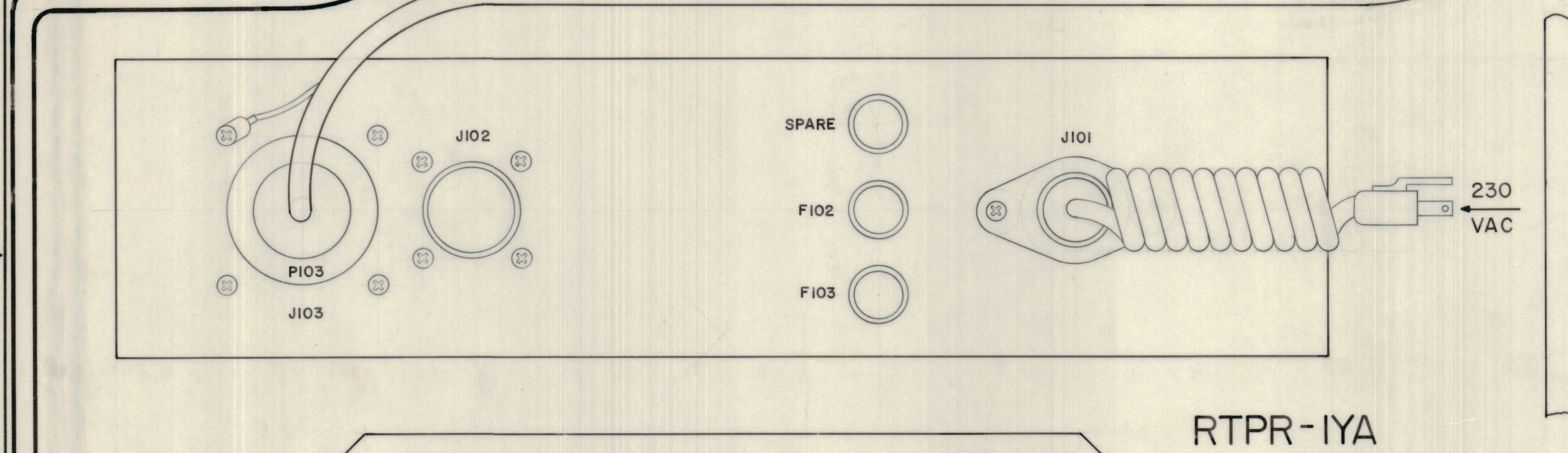
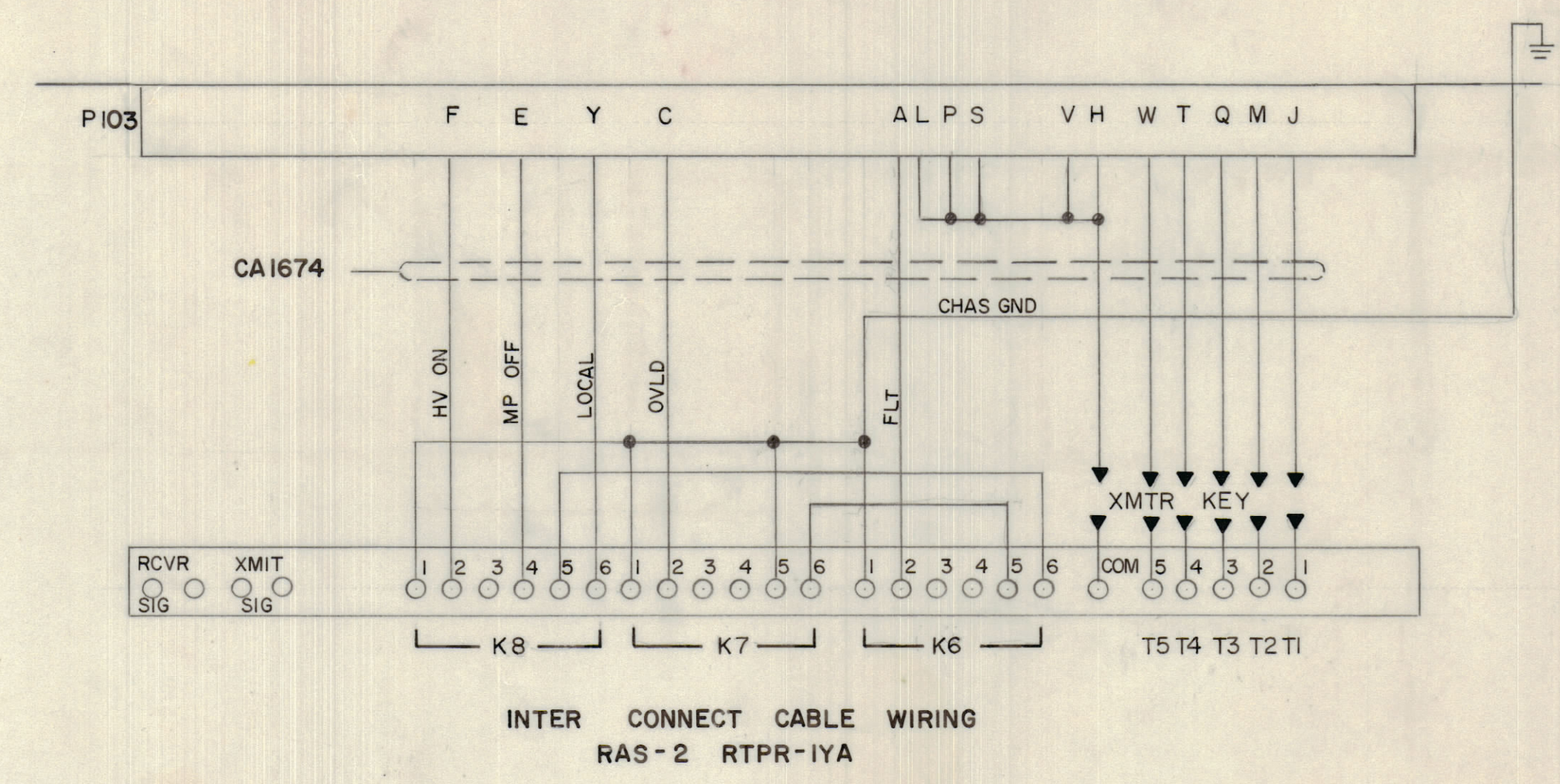
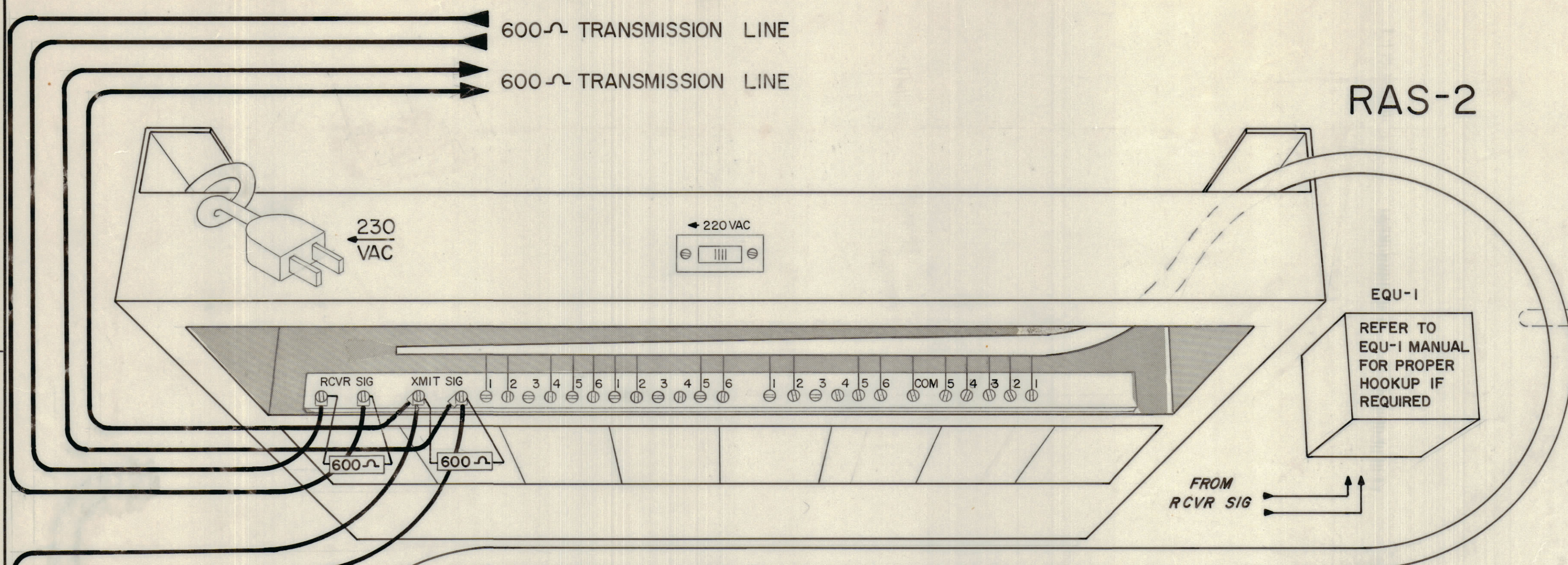

QTY / UNIT	MODEL USED ON	ASS'Y NO.
	MFTR 10 KE5	
APPLICATION		
CODE		

UNLESS OTHERWISE SPECIFIED DIMENSIONS ARE IN INCHES AND INCLUDE CHEMICALLY APPLIED OR PLATED FINISHES

TOLERANCES ON
DECIMALS FRACTIONS
.X ± .05 ± 1/64
.XX ± .01 ANGLES
.XXX ± .005 ± 0°-30°

MATERIAL

FINISH

QTY. REQ.	ITEM	PART NO.	DESCRIPTION	SYMBOL
LIST OF MATERIAL				
THE TECHNICAL MATERIEL CORP. MAMARONECK, NEW YORK				
INSTALLATION DIAGRAM				
ADC-3T SYSTEM HOOKUP				
SIZE	CODE	IDENT NO.	DWG NO.	ISSUE
D	82679	ID 402		0
SCALE				SHEET 3 OF 4

NOTICE TO PERSONS RECEIVING THIS DRAWING
THE TECHNICAL MATERIEL CORPORATION claims proprietary right in the material disclosed herein. This drawing is issued in confidence for engineering information only and may not be reproduced or used to manufacture anything shown herein without permission from THE TECHNICAL MATERIEL CORPORATION to the user. This drawing is loaned for mutual assistance and is subject to recall at any time.

REVISIONS							
E.M.N.O.	DRAFT	CHKD	ZONE	LTR	DESCRIPTION	DATE	APPROVED
	2			2	ORIGINAL RELEASE FOR PRODUCTION	3-23-73	

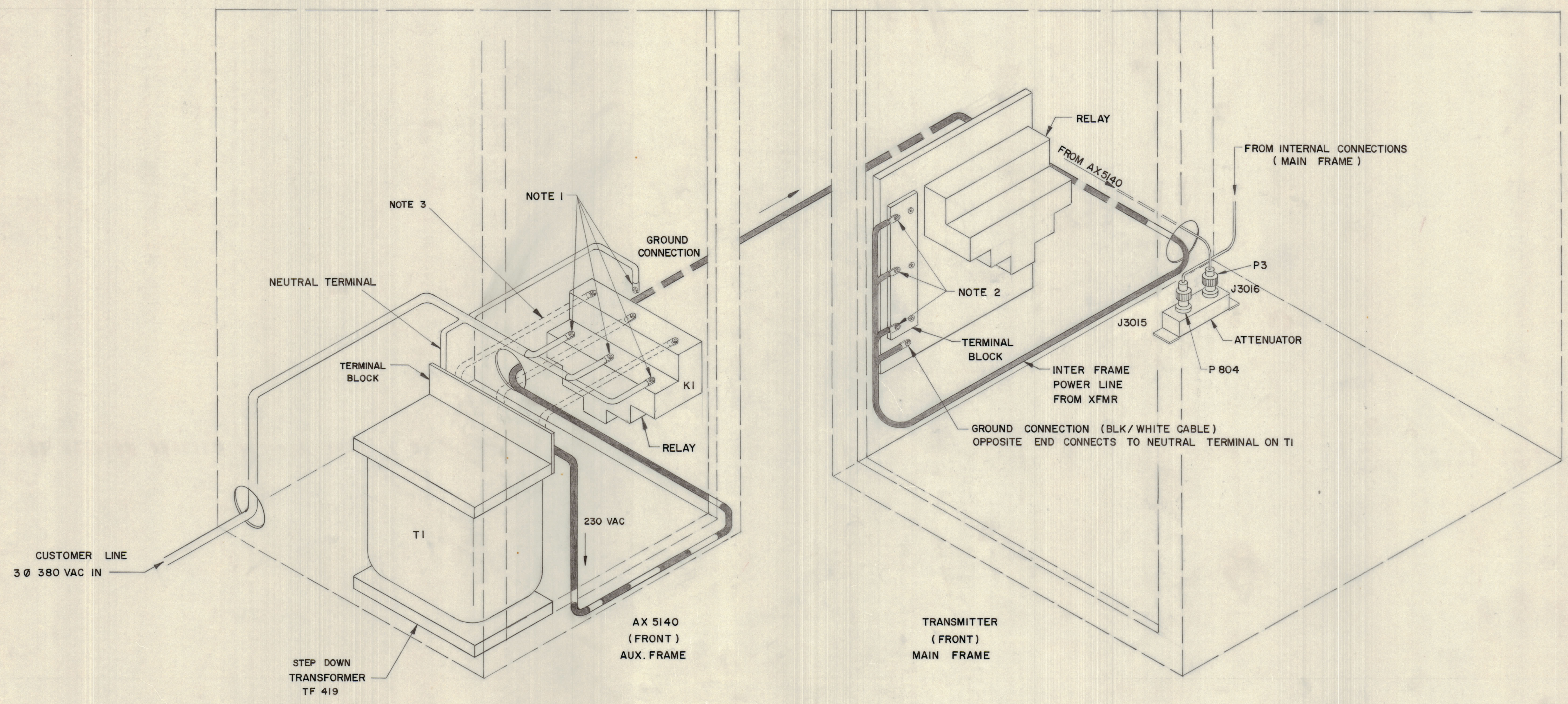

- NOTES**
1. CUSTOMER LINE IN, TO BE CONNECTED TO MAIN POWER RELAY AND GROUND AS SHOWN.
 2. INTER FRAME POWER LINE TO BE CONNECTED FROM MAIN FRAME TO TERMINAL BLOCK ON TRANSFORMER IN AUX FRAME
 3. CUSTOMER TO HOOK UP 380 VAC LINE FROM RELAY TO 380 VAC TERMINALS ON TRANSFORMER

MTRIOKE		
QTY / UNIT	MODEL USED ON	ASSY NO.
APPLICATION		
CODE		
<small>NOTICE TO PERSONS RECEIVING THIS DRAWING</small> <small>THE TECHNICAL MATERIEL CORPORATION claims proprietary right in the material disclosed hereon. This drawing is issued in confidence for engineering information only and may not be reproduced or used to manufacture anything shown hereon without permission from THE TECHNICAL MATERIEL CORPORATION to the user. This drawing is loaned for mutual assistance and is subject to recall at any time.</small>		

QTY. REQ.	ITEM	PART NO.	DESCRIPTION	SYMBOL
LIST OF MATERIAL				
FINAL APPROVAL		DATE	THE TECHNICAL MATERIEL CORP.	
MECH. DES.		DATE	MAMARONECK, NEW YORK	
ELECT. DES.		DATE	INSTALLATION DIAGRAM	
CHECKED		DATE	PRIMARY AC HOOKUP	
DRAWN		DATE	SIZE CODE IDENT NO. DWG NO.	
MATERIAL			D 82679	ID 402
FINISH			SCALE NTS SHEET 4 OF 4	