

REVISIONS				
ZONE	LTR	DESCRIPTION	DATE	DRAFT

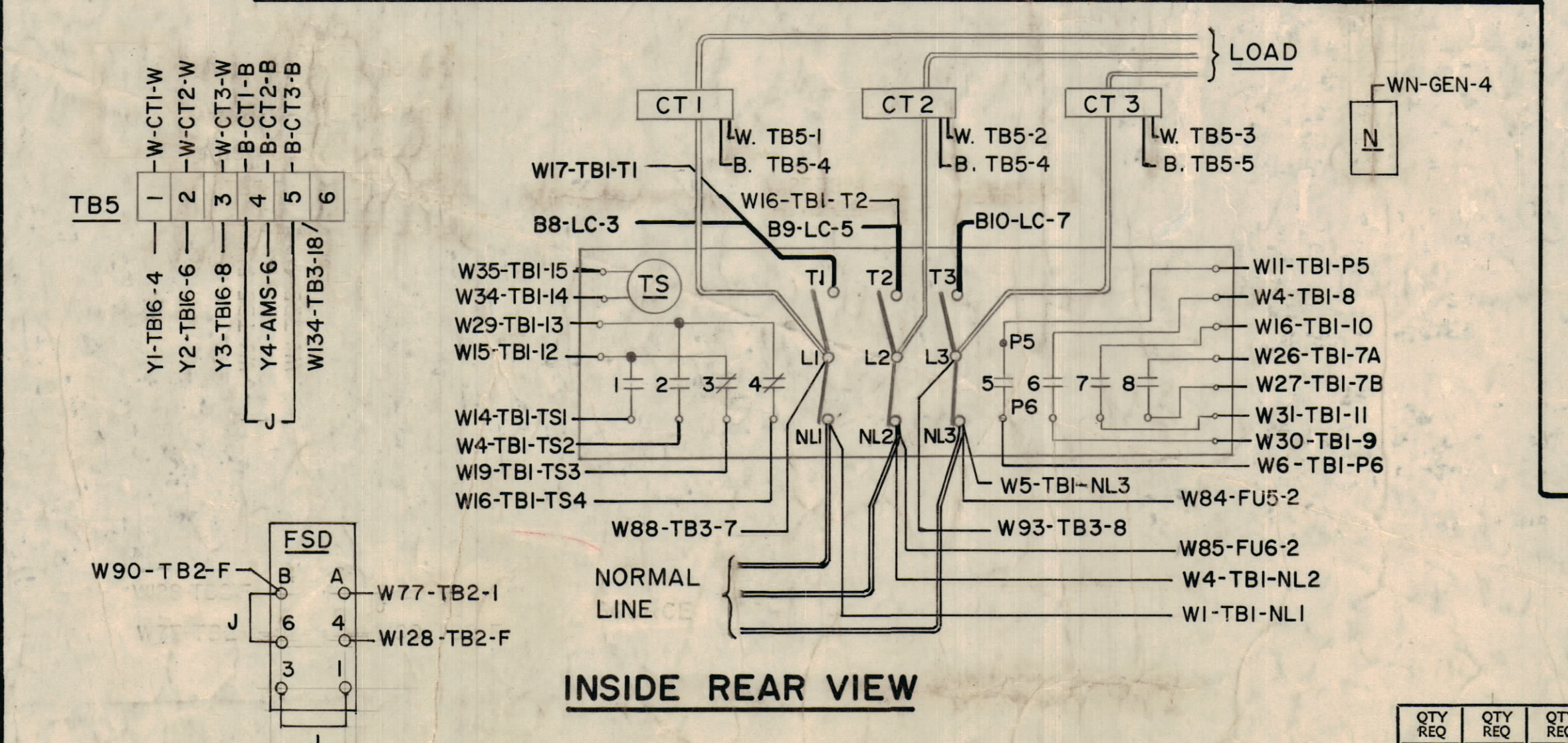

QTY REQ	QTY	ITEM	PART NO.	MANUFACTURER	DESCRIPTION	SYM
		W78-FU4-2				
		W77-FSD-A				
		W128-FSD-4				
		W90-FSD-B				

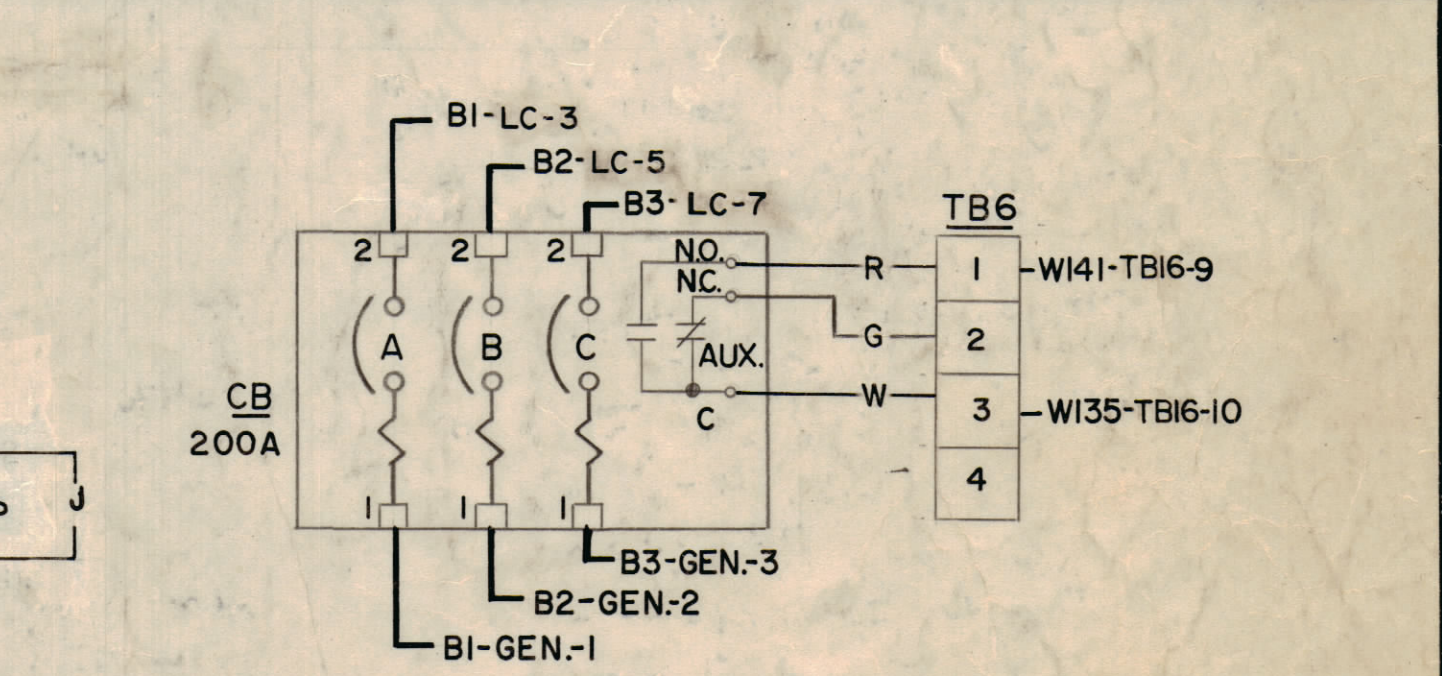
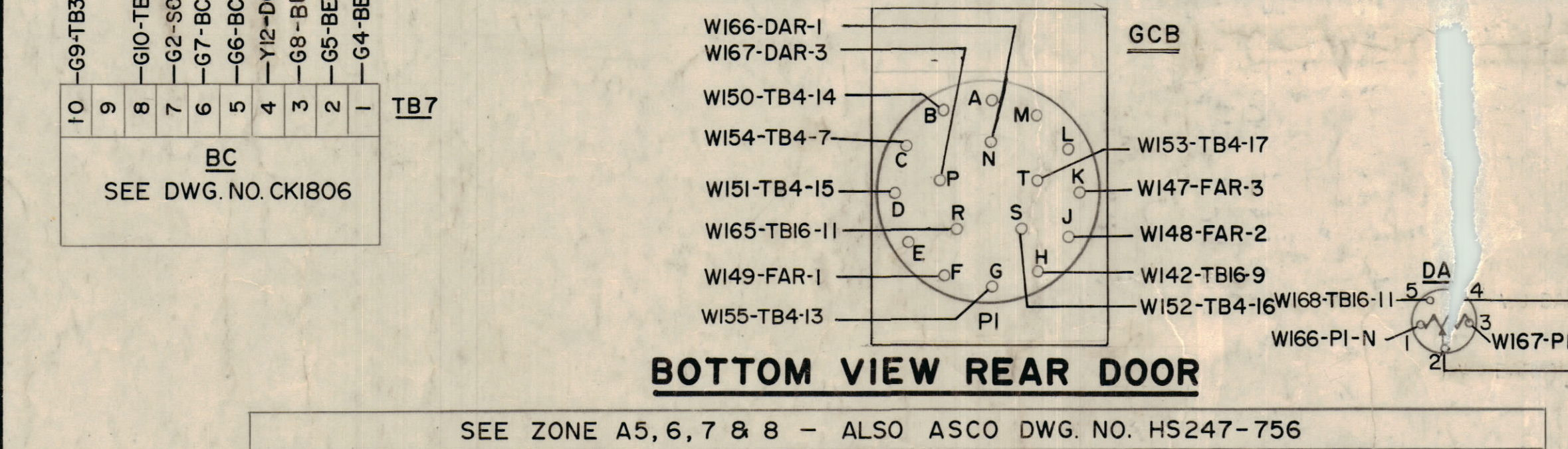
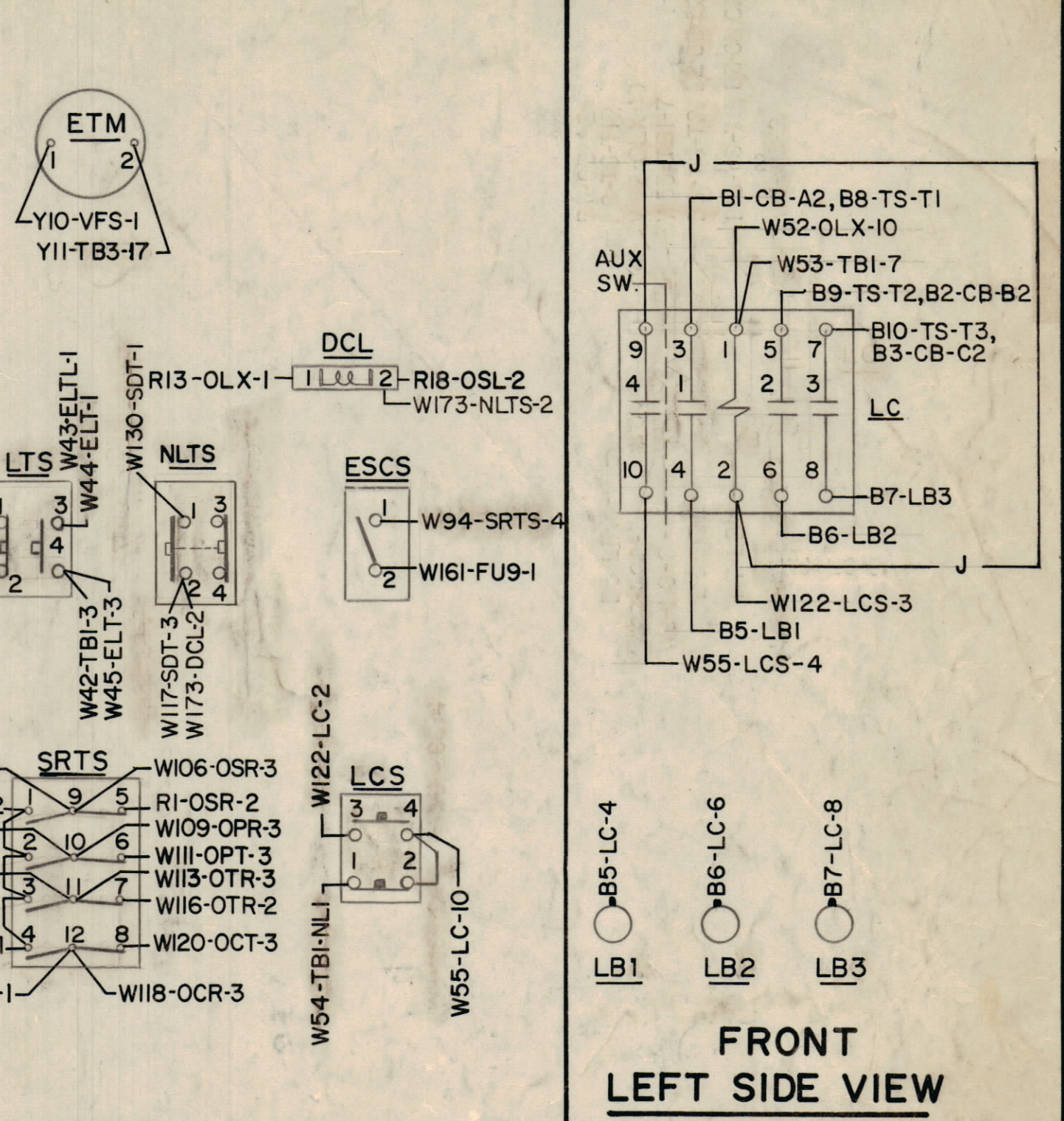
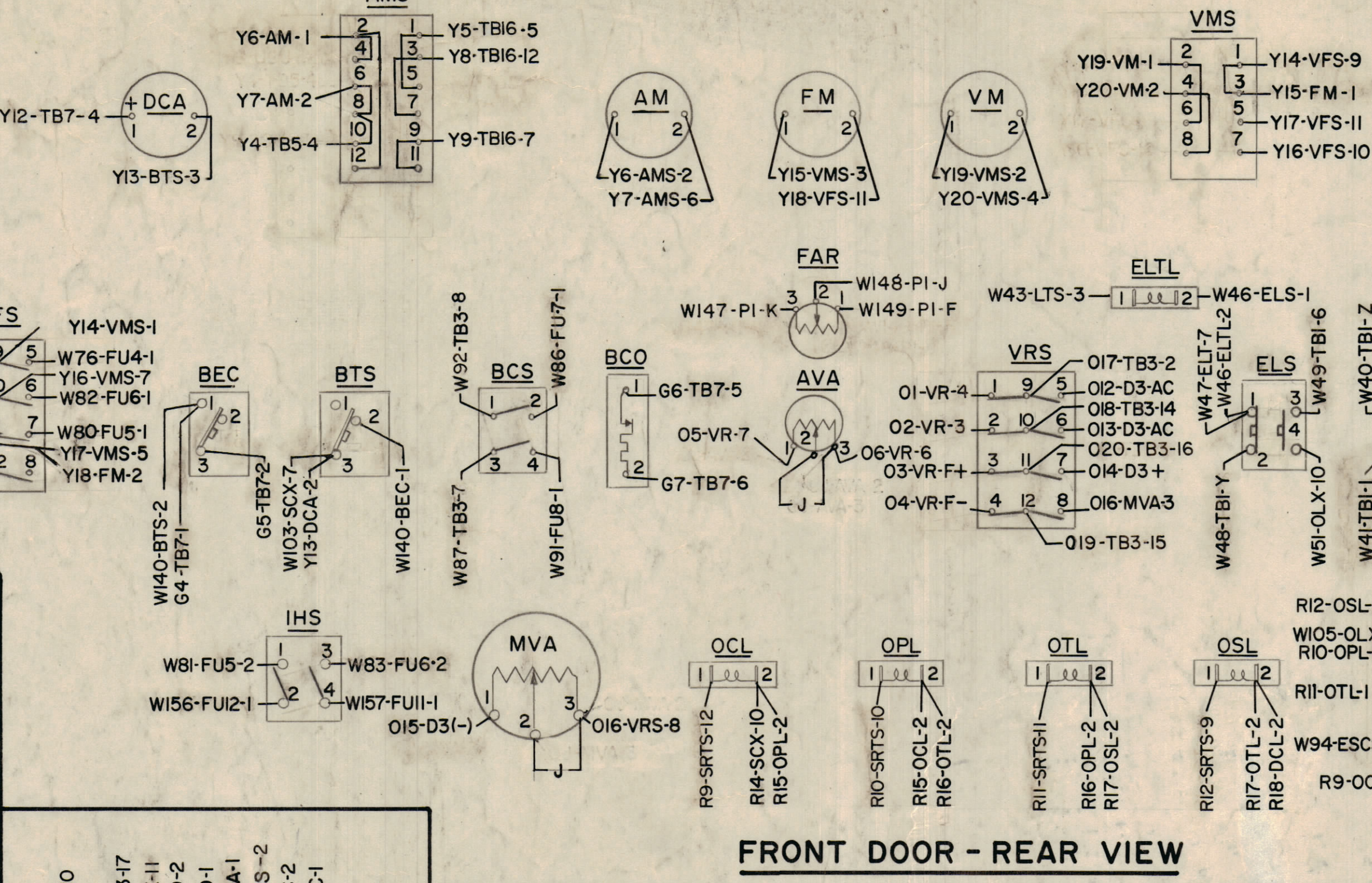
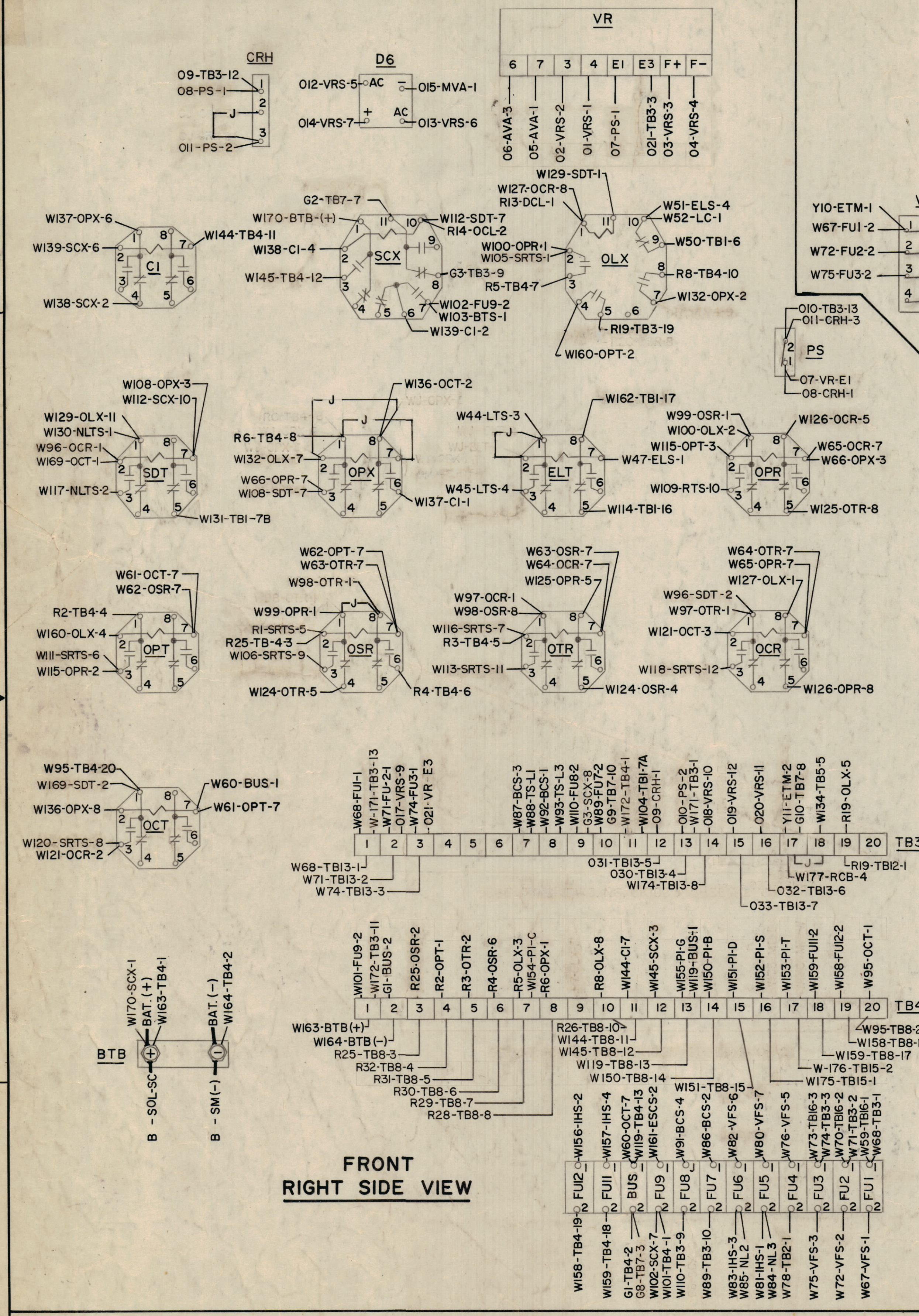
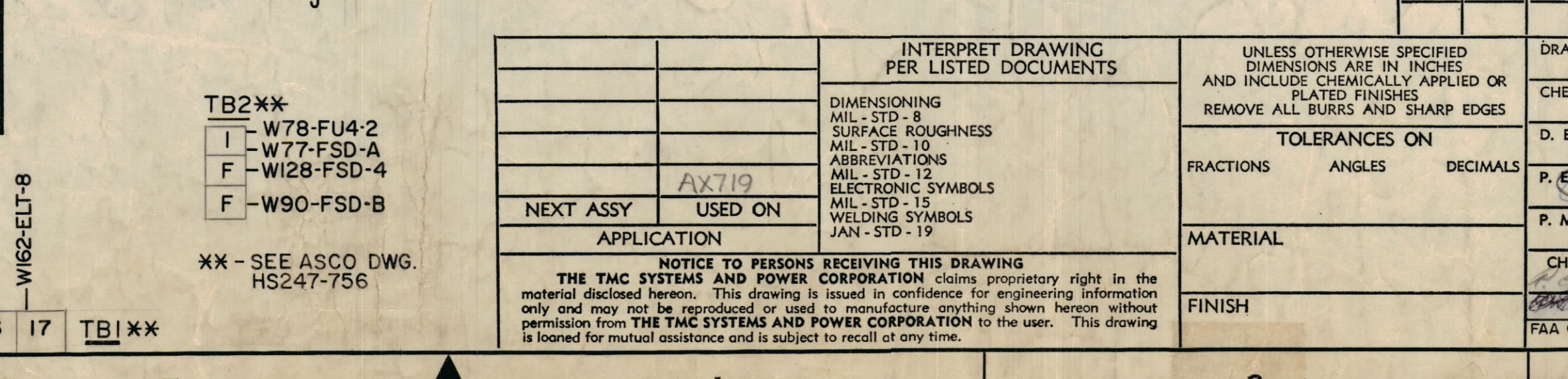

PARTS LIST						
QTY REQ	QTY	ITEM	PART NO.	MANUFACTURER	DESCRIPTION	SYM
		W78-FU4-2				
		W77-FSD-A				
		W128-FSD-4				
		W90-FSD-B				

THE TMC SYSTEMS AND POWER CORPORATION
SPRINGFIELD, VIRGINIA

50 KW ENGINE GENERATOR SET
WIRING DIAGRAM
(CONTROL CABINET)

SIZE: D, CODE IDENT NO: 24146, DWG. NO: CK1805

SCALE: SHEET 1 OF