

ISSUE FROM	25
DATE	10/22/44
CH. NO.	24
DRAWN	CH. NO. 24
DATE	10/22/44
BY	W. J. B.
REVISED	10/22/44
BY	W. J. B.
DATE	10/22/44
BY	W. J. B.
DATE	10/22/44
BY	W. J. B.
DATE	10/22/44
BY	W. J. B.



MISSING SYMBOLS

C101 THRU C119	C129 C142	J112	R185 THRU R190	R194	R195 R221	XY109	XY110
C120	C150	C154	C155	C159	R234	R236	R267 THRU R272
C160	C165	C172	C195	C295	R150		
C258	C259	C260	C307	C308			
CR101 THRU CR106	CR108	CR110					
CR107	CR108						
E							
I							
L101							
L102							
L103							
L104							
L105							
L106							
L107							
L108							
L109							
L110							
L111							
L112							
L113							
L114							
L115							
L116							
L117							
L118							
L119							
L120							
L121							
L122							
L123							
L124							
L125							
L126							
L127							
L128							
L129							
L130							
L131							
L132							
L133							
L134							
L135							
L136							
L137							
L138							
L139							
L140							
L141							
L142							
L143							
L144							
L145							
L146							
L147							
L148							
L149							
L150							
L151							
L152							
L153							
L154							
L155							
L156							
L157							
L158							
L159							
L160							
L161							
L162							
L163							
L164							
L165							
L166							
L167							
L168							
L169							
L170							
L171							
L172							
L173							
L174							
L175							
L176							
L177							
L178							
L179							
L180							
L181							
L182							
L183							
L184							
L185							
L186							
L187							
L188							
L189							
L190							
L191							
L192							
L193							
L194							
L195							
L196							
L197							
L198							
L199							
L200							
L201							
L202							
L203							
L204							
L205							
L206							
L207							
L208							
L209							
L210							
L211							
L212							
L213							
L214							
L215							
L216							
L217							
L218							
L219							
L220							
L221							
L222							
L223							
L224							
L225							
L226							
L227							
L228							
L229							
L230							
L231							
L232							
L233							
L234							
L235							
L236							
L237							
L238							
L239							
L240							
L241							
L242							
L243							
L244							
L245							
L246							
L247							
L248							
L249							
L250							
L251							
L252							
L253							
L254							
L255							
L256							
L257							
L258							
L259							
L260							
L261							
L262							
L263							
L264							
L265							
L266							
L267							
L268							
L269							
L270							
L271							
L272							
L273							
L274							
L275							
L276							
L277							
L278							
L279							
L280							
L281							
L282							
L283							
L284							
L285							
L286							
L287							
L288							
L289							
L290							
L291							
L292							
L293							
L294							
L295							
L296							
L297							
L298							
L299							
L300							

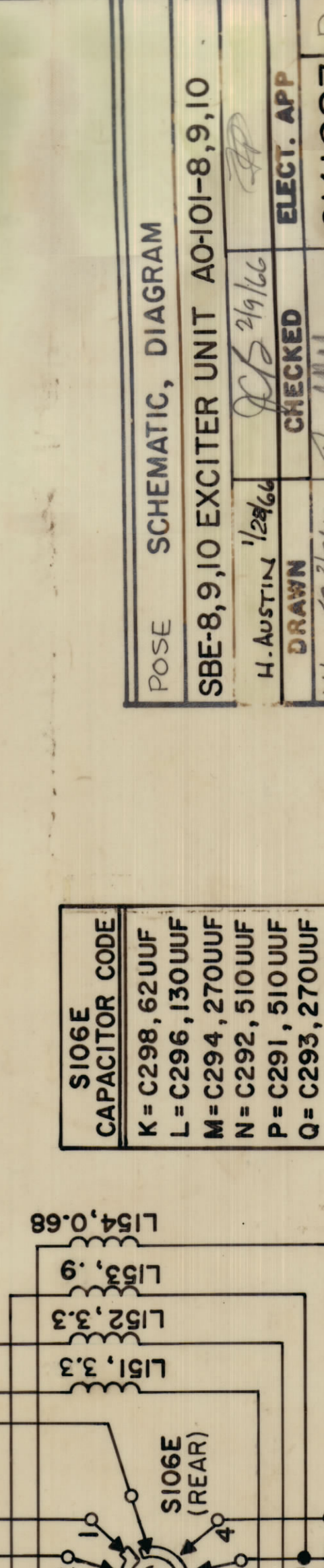
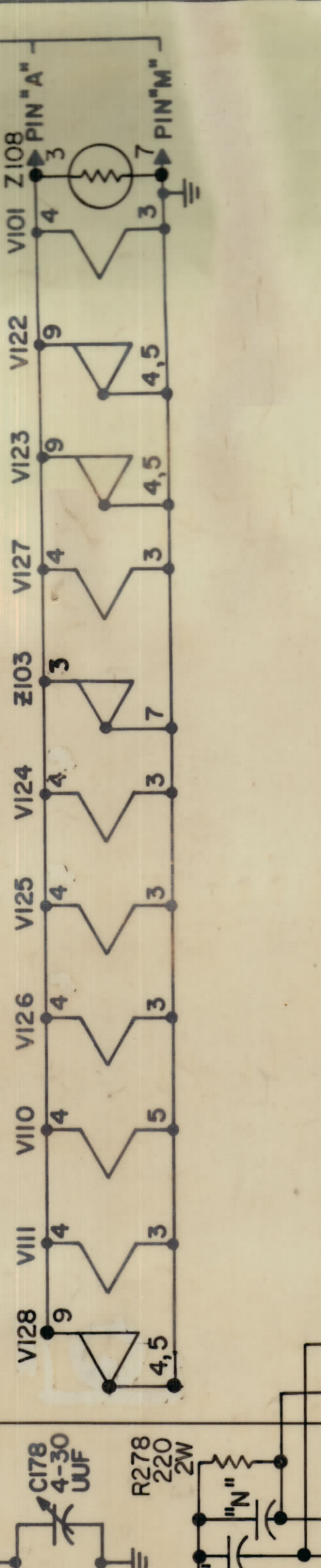
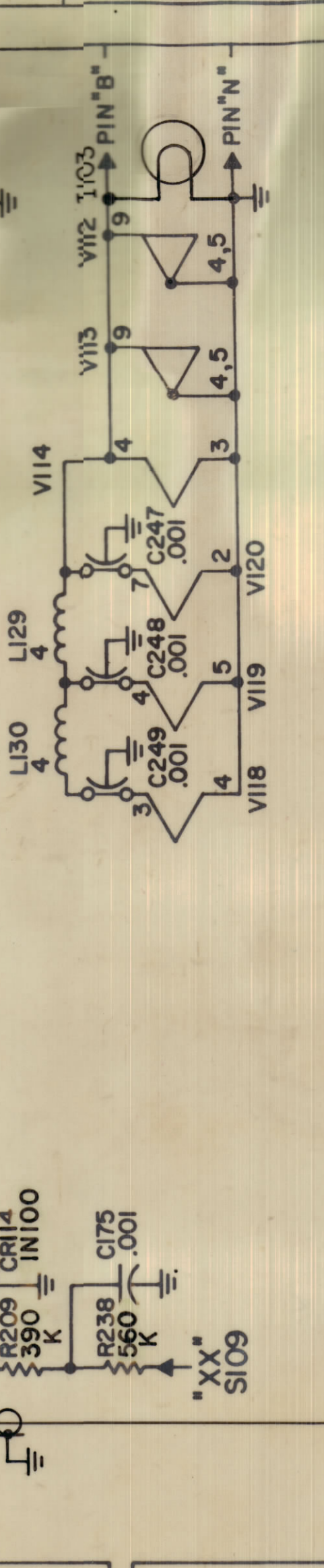
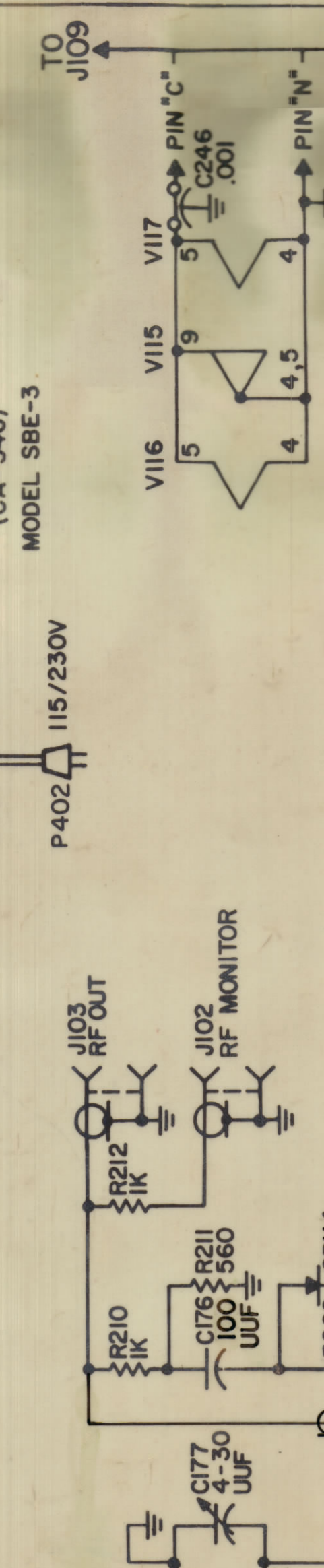
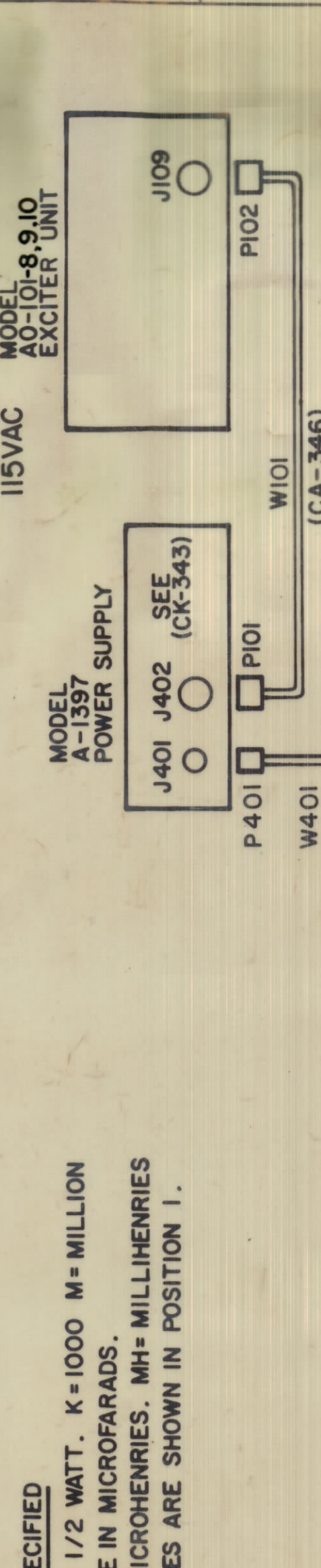
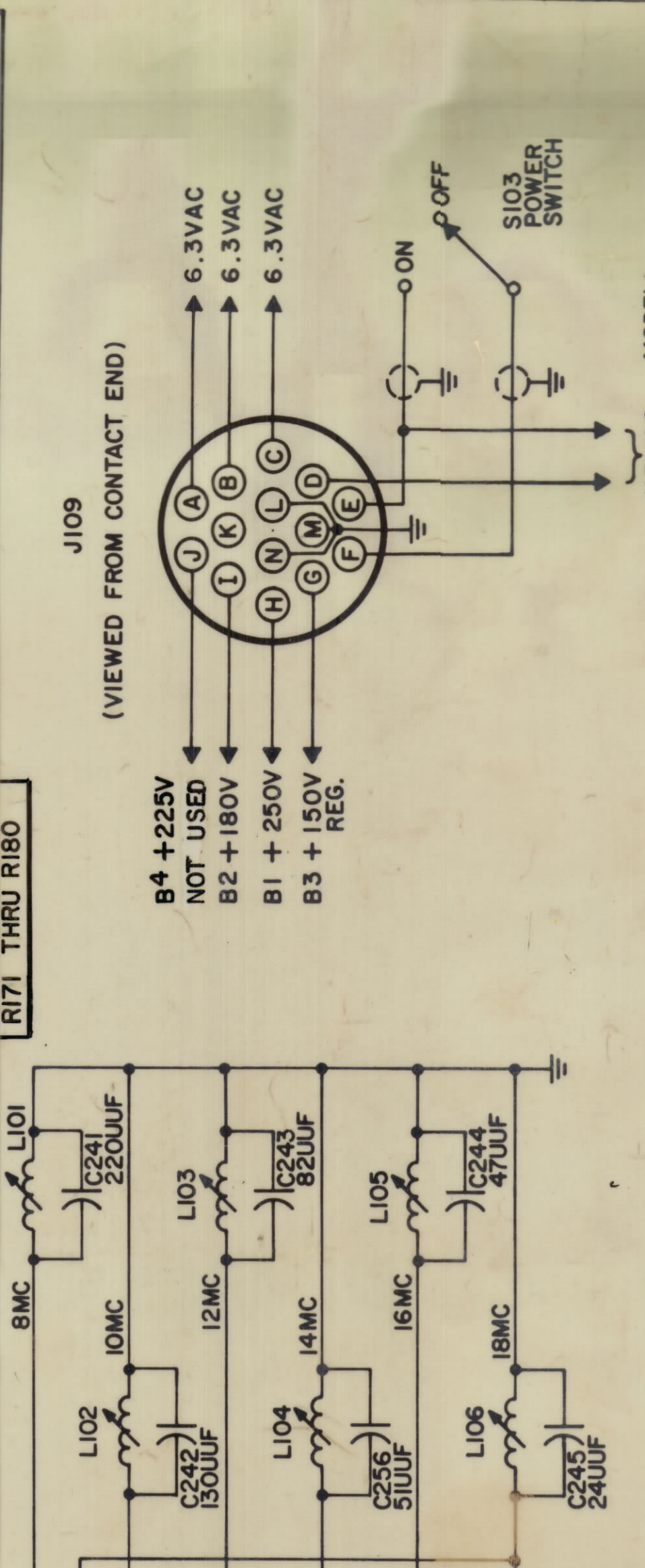

POSE SCHEMATIC DIAGRAM

SBE-8,9,10 EXCITER UNIT A0-101-8,9,10

DRAWN: H. AUSTIN
CHECKED: J. H. HALL
ELECT. APP: J. H. HALL
DATE: 11/14/54

CK 1083 D
SHEET 2 OF 2

LAST SYMBOLS

C312	PS103
CR116	R232
E102	S110
J103	T108
K101	TB101
L154	V128
M101	XY121
P108	Z112
W101	

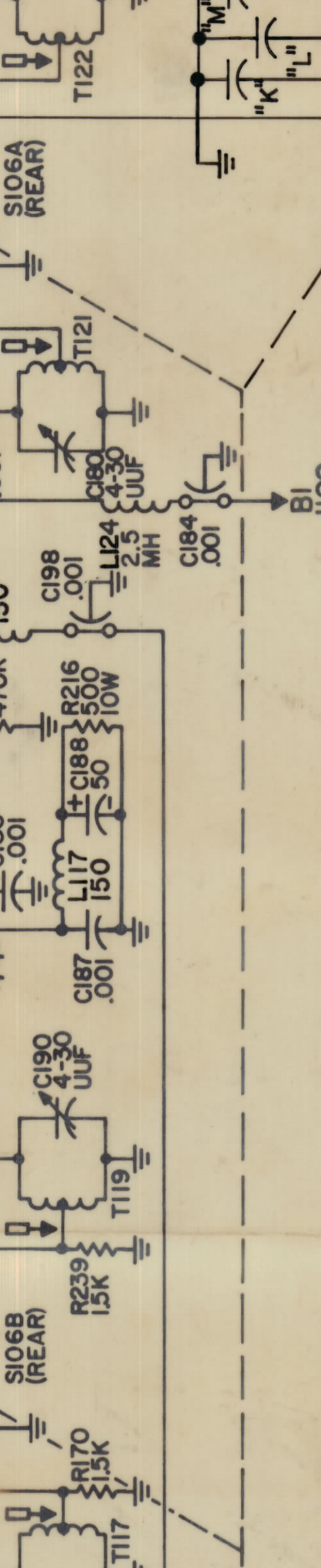
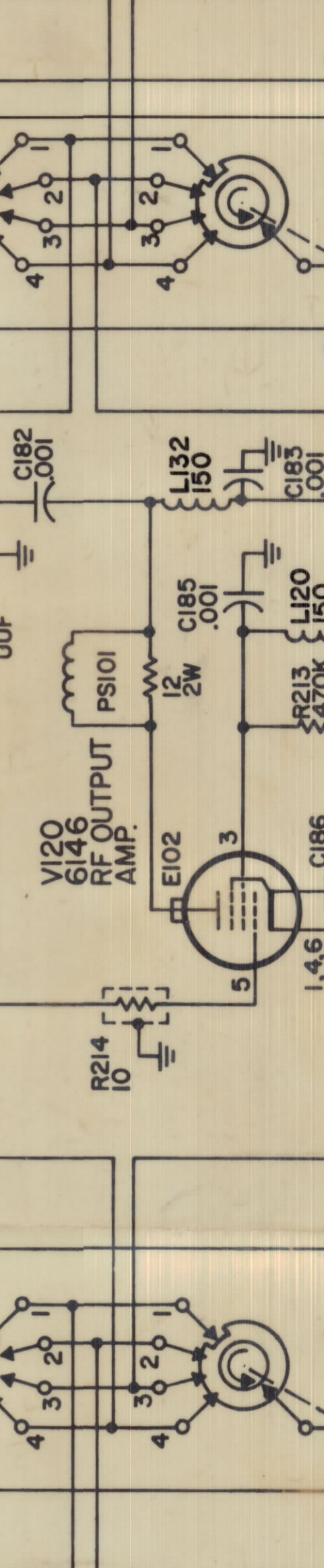
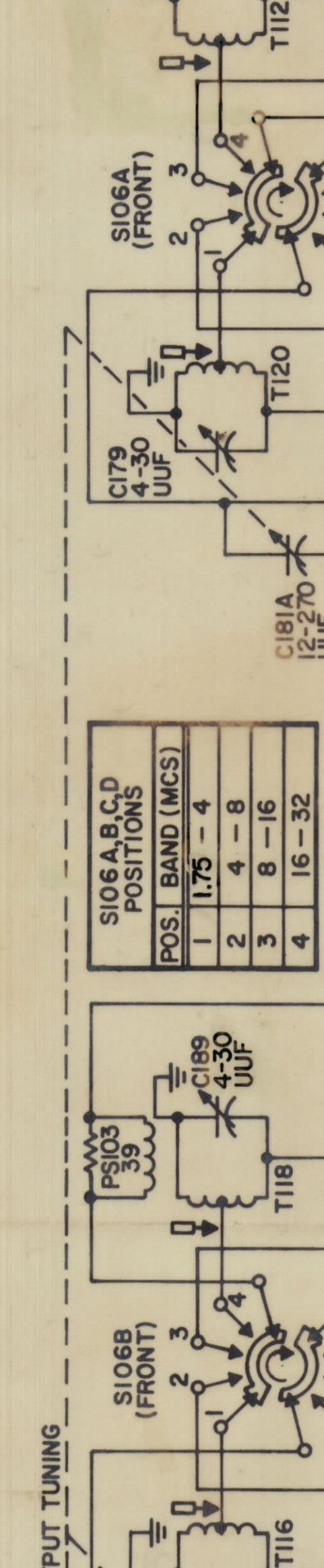
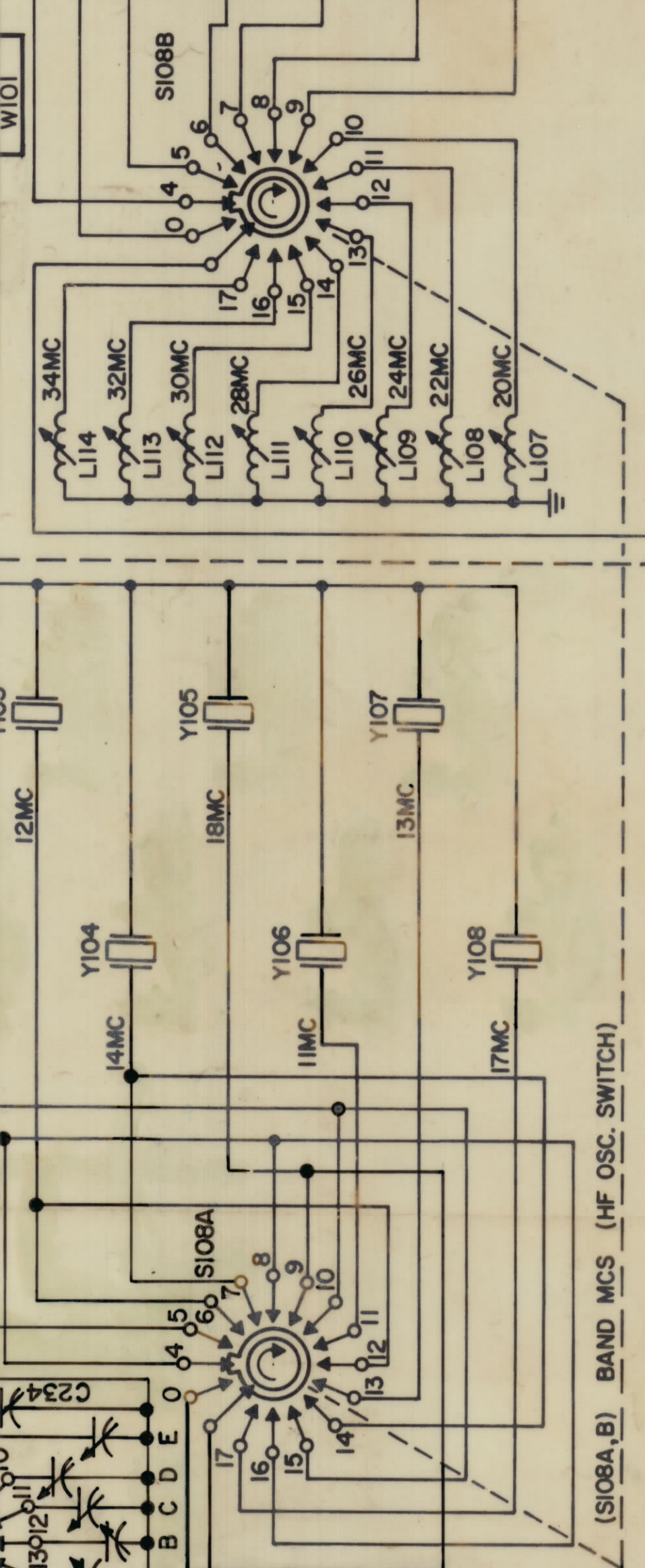

UNLESS OTHERWISE SPECIFIED

1 - ALL RESISTORS ARE 1/2 WATT. K=1000 M=MILLION

2 - ALL CAPACITORS ARE IN MICROFARADS.

3 - ALL COILS ARE IN MICROHENRIES. MH=MILLIHENRIES

4 - ALL ROTARY SWITCHES ARE SHOWN IN POSITION 1.

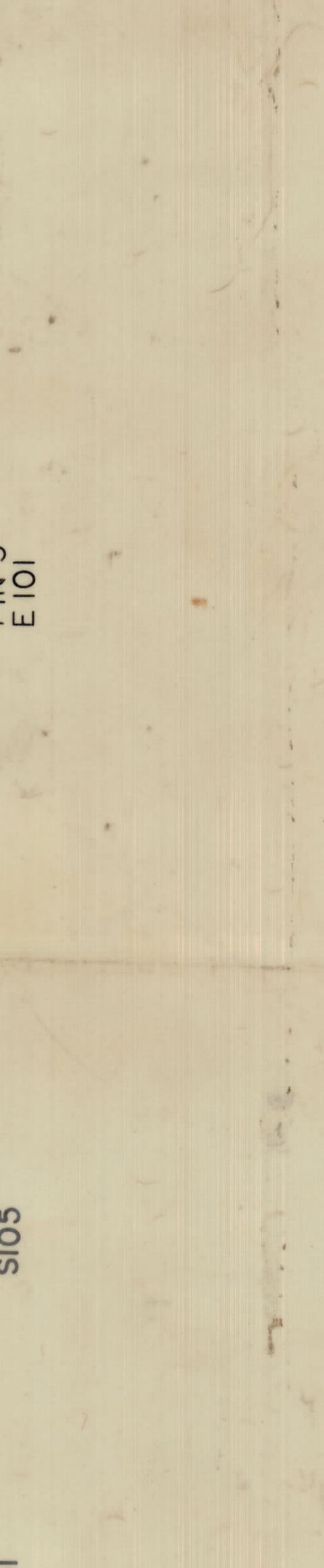
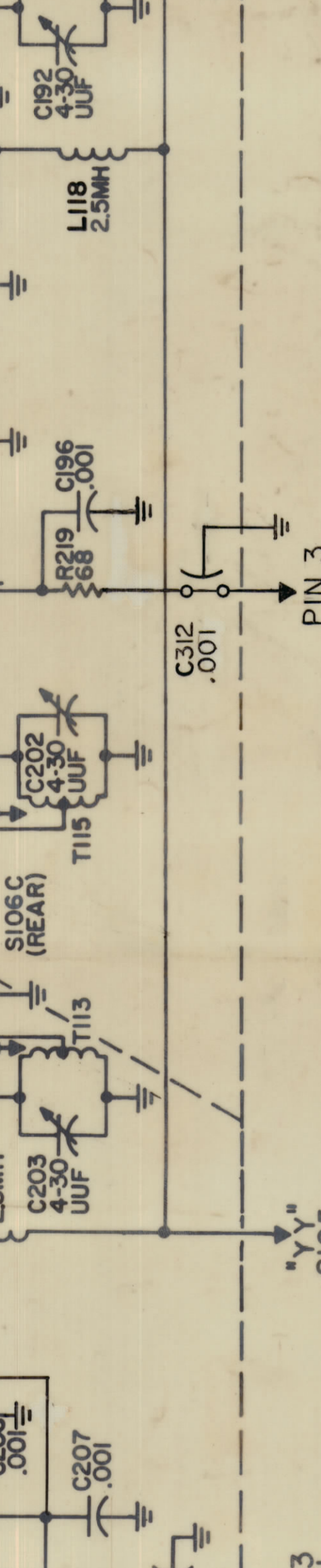
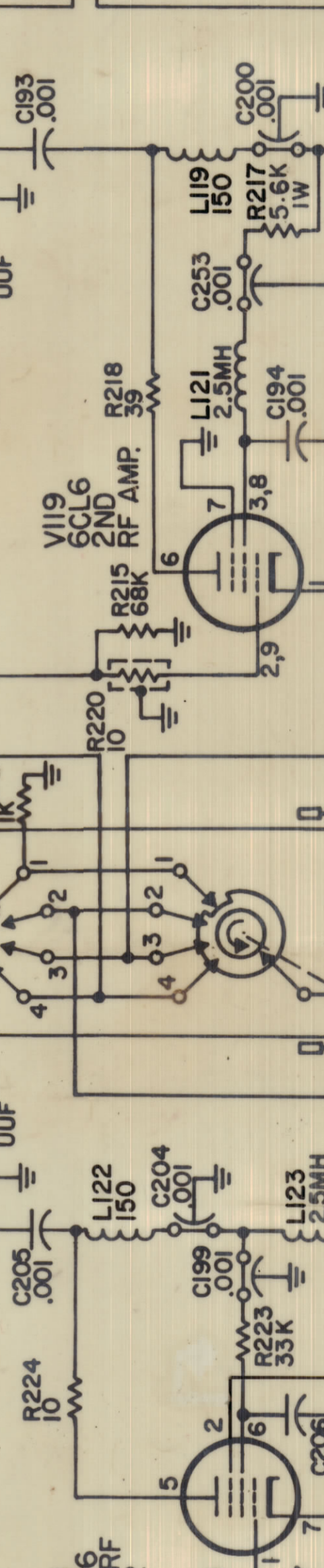
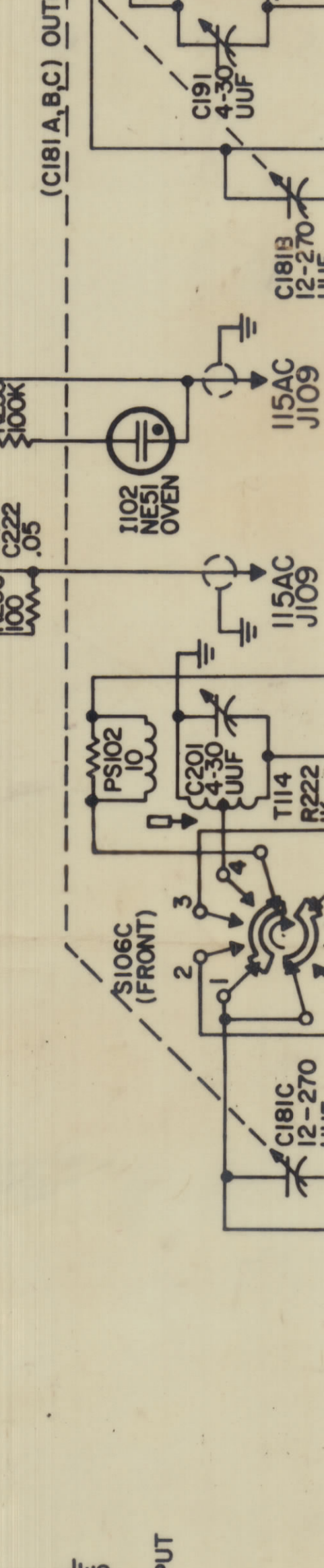
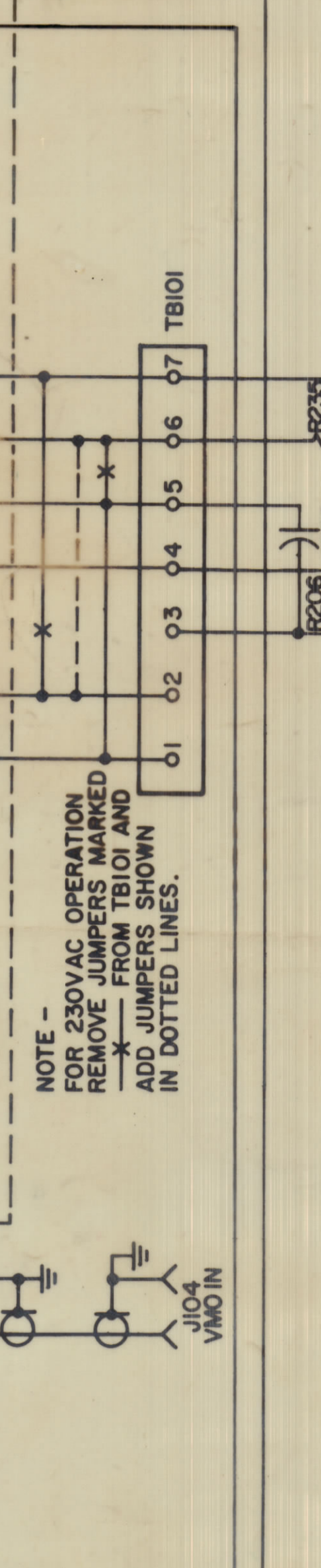
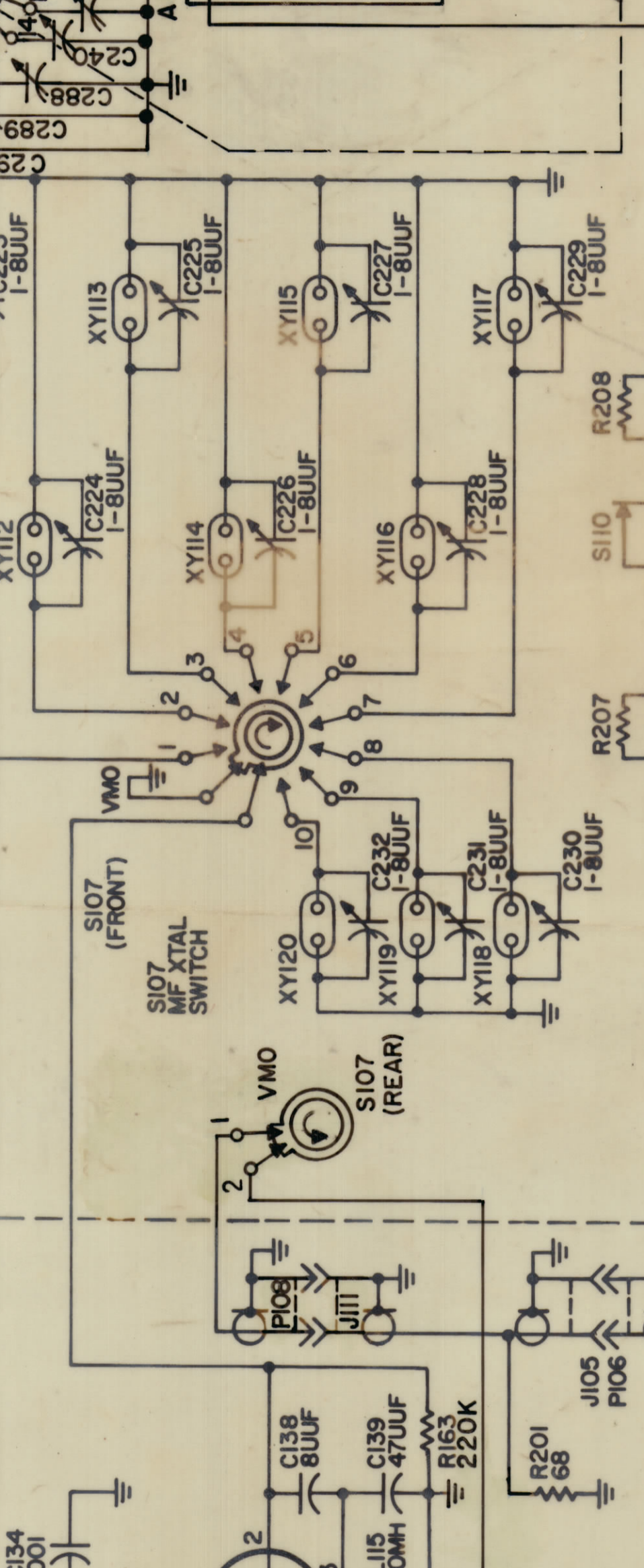
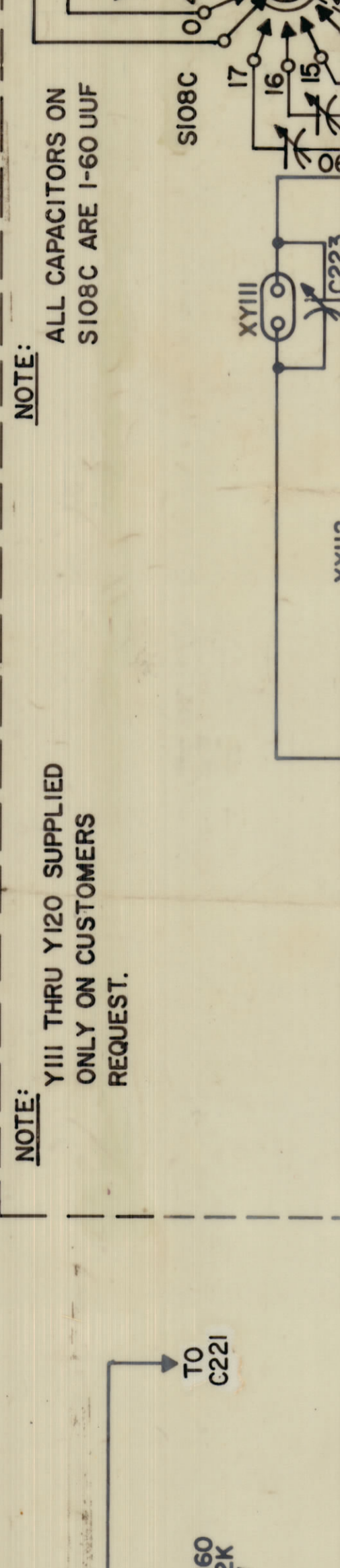

NOTE:

Y110 THRU Y120 SUPPLIED ONLY ON CUSTOMERS REQUEST.

ALL CAPACITORS ON S108C ARE 1-60 UUF

