



**instruction book**

*Part 2*

---

**651S-1/1A**  
**General Purpose**  
**HF Receiver**

---

*Part 2 includes:*

*Parts List*

*523-0764057*

---

*Printed in the United States of America*

---

Collins Radio Company welcomes your comments concerning this instruction book. Although every effort has been made to keep it free of errors, some do occur. When reporting a specific problem, please describe it briefly and include the section part number, the paragraph or figure number, and the page number.

Send your comments to: Collins Radio Company  
Publications Engineering Department  
Mail Station 108-275  
Cedar Rapids, Iowa 52406

---

# 651S-1/1A

## General Purpose

### HF Receiver



parts list

Printed in USA

523-0764057-104218  
4th Edition, 1 October 1972  
1st Revision, 15 April 1973

## list of illustrations

<i>Figure</i>	<i>Page</i>	<i>Figure</i>	<i>Page</i>
1 651S-1/1A General Purpose HF Receiver.....	14	22 ISB Circuit Card Assembly (A3) 778-2952-001.....	124
2 Frequency Control Circuit Card Assembly (A14) 788-9283-001.....	20	23 Audio Amplifier Circuit Card Assembly (A2) 778-2948-003, -005.....	135
3 Synthesizer VCO Circuit Card Assembly (A13) 793-9331-003.....	26	24 Power Supply Regulator Circuit Card Assembly (A1)	
4 DCU Circuit Card Assembly (A9) 774-7842-001.....	29	778-2949-001.....	141
5 Synthesizer Mixer Circuit Card Assembly (A12) 793-9332-002.....	37	25 Audio Amplifier Circuit Card Assembly (A2) 778-2948-002, -004.....	147
6 Synthesizer Reference Circuit Card Assembly (A11) 793-9333-002.....	39	26 Receiver Chassis Assembly 606-9423-003, -005, -006, -007, -009.....	156
7 Deleted.....	44	27 Keep-Alive Power Switch 609-0928-001.....	160
8 Synthesizer Divider Circuit Card Assembly (A10) 793-9334-002.....	45	28 IF Blanker 606-9884-001.....	162
9 Synthesizer Divider Circuit Card Assembly (A10) 793-9334-006.....	47	29 Audio Amplifier 606-9708-001.....	163
10 Deleted.....	51	30 Electronic Component Assembly 618-7105-001.....	166
11 DCU Circuit Card Assembly (A9) 793-9414-001.....	52	31 DCU Circuit Card Assembly (A9) 624-5781-001.....	168
12 TCU Circuit Card Assembly (A9) 783-9480-001.....	58	32 Variable Beat Frequency Oscillator Assembly (A2A1)	
13 Interconnect Circuit Card Assembly (A8)		609-0552-001, -002.....	173
778-2924-004, -006, -007.....	63	33 Variable Beat Frequency Oscillator Assembly (A2A1)	
14 DCFE Circuit Card Assembly (A8) 624-5744-001.....	65	618-7705-001, -002.....	181
15 Decoder/Driver Circuit Card Assembly (A7) 778-2928-003.....	72	34 Decoder/Driver Circuit Card Assembly (A7) 608-9087-001.....	187
16 RF Module Assembly (A6) 790-1048-008, -010.....	77	35 Decoder/Driver Circuit Card Assembly (A7) 608-9121-001.....	189
17 Diode Switching Circuit Card Assembly (P/o A6)		36 RF Module Assembly (A6) 790-1048-020, -021.....	191
778-2934-002, -003.....	89	37 Radio Frequency Mixer (A6A1) 618-3258-001.....	196
18 VLF Mixer (P/o A6) 609-1643-001.....	94	38 Filter/Diode Switch Assembly (A6A2) 618-7678-001, -002.....	204
19 IF Filter Circuit Card Assembly (A5A1)		39 Front Panel Assembly 606-9425-003, -004, -005.....	208
797-3571-001, -006, -007, -010, -011, -012.....	97	40 Radio Receiver Power Supply 606-9424-002, -004, -005, -006.....	217
20 IF Filter Circuit Card Assembly (A5A2)		41 Auto Scan Control Circuit Card Assembly 783-9368-001.....	223
797-3585-002, -003, -010, -011, -012.....	108	42 699J-1 Receiver Adapter.....	226
21 IF Amplifier Circuit Card Assembly (A4)			
778-2951-001, -003, -004.....	112		



# parts list

## 1. INTRODUCTION

### 1.1 General

The purpose of this parts list is for identification, requisition, and issuance of parts.

### 1.2 Group Assembly Parts List

FIG - ITEM Column -- Digits preceding the dash refer to the figure number. Digits following the dash are the item numbers assigned in sequence to correspond with the item numbers on the illustration.

PART NO Column -- Listed are MIL standard, vendor, or Collins Radio Company part numbers. Collins part numbering system consists of 10 digits as follows: a 3-digit family number, a 4-digit serial number, and a 3-digit dash number.

INDENT Column -- Items are coded 1, 2, 3, etc, to indicate the relationship to the next higher assembly.

DESCRIPTION Column -- The noun name, modifier, required descriptive information, federal manufacturer code for each vendor part number, reference designation for each electrical item, attaching part (AP), and reference to other figures and effectivities are listed.

Attaching parts are identified by (AP) following the part or parts they attach.

Effectivities are identified by MCN (manufacture control number) 101 and up or CI (configuration identifier) 5-digit number recorded on each chassis and/or replaceable assembly.

USABLE ON CODE Column -- Part variations within the groups of equipment are indicated by a letter symbol (A, B, C, etc). The absence of the symbol indicates parts apply to all models.

UNITS PER ASSY Column -- Quantities specified are per item number. The letters AR denote the selection of parts as required. The letters REF refer to an assembly completely assembled on a preceding figure and illustration.

### 1.3 Numerical Index

PART NUMBER Column -- Part numbers are in alphanumeric sequence.

FIG - ITEM Column -- Digits preceding the dash refer to the figure number. Digits following the dash are the item numbers.

TTL REQ Column -- Listed is the total quantity of parts or assemblies for the equipment.

### 1.4 Reference Designation Index

REFERENCE DESIGNATION Column -- Reference designations are listed in alphanumeric sequence.

FIG - ITEM Column -- Digits preceding the dash refer to the figure number. Digits following the dash are the item numbers.

PART NUMBER Column -- Part numbers listed in this column have been assigned reference designation symbols.

## HOW TO USE THIS PARTS LIST

1. FIND PAGE NO. IN LIST OF ILLUSTRATIONS

5. FIND PART NO. IN NUMERICAL INDEX

2. FIND PART AND ITS ITEM NO.

7. LOCATE PART ON ILLUSTRATION

The diagram illustrates the process of finding a part number. It shows three main sections:
 

- REFERENCE DESIGNATION INDEX:** A table with columns for REFERENCE DESIGNATION, FIG. NO., PART NUMBER, and ILLUSTRATION. An arrow points from this section to the Numerical Index.
- NUMERICAL INDEX:** A table with columns for PART NUMBER, FIG. NO., QUANTITY, and PART NUMBER. An arrow points from this section to the Group Assembly Parts List.
- GROUP ASSEMBLY PARTS LIST:** A detailed list of parts with columns for FIG. NO., PART NO., QTY., UOM, and REF. An arrow points from this section to an illustration of a mechanical part.

 An illustration of a mechanical assembly is shown with numbered callouts (1-10) pointing to various components. The parts list includes entries for these numbered parts, such as 'RECTOR' and 'RECTOR INT. COMP.'.

HOW TO FIND THE PART NUMBER IF THE SECTION OR SYSTEM OF THE EQUIPMENT IN WHICH THE PART IS USED IS KNOWN:

- (1) Refer to the List of Illustrations and find the page number for the Major Assembly or System in which the part is used.
- (2) Locate the part item number and/or reference designation on the illustration.
- (3) Find the item number on the Group Assembly Parts List page to determine complete description.
- (4) If only the reference designation is known, refer to the Reference Designation Index to find the part number.

HOW TO FIND THE ILLUSTRATION FOR A PART IF THE PART NUMBER IS KNOWN:

- (5) Refer to the Numerical Index and find the part number.
- (6) Turn to the Group Assembly Parts List and find the first figure and item number indicated in the Numerical Index for that part. If this figure shows the part in a section or system of the equipment other than the one desired, refer to the other figure numbers listed in the Numerical Index.
- (7) On the illustration, find item number determined in step (6).

*1.5 Manufacturer's Code, Name, and Address*

CODE	MANUFACTURER'S NAME AND ADDRESS	CODE	MANUFACTURER'S NAME AND ADDRESS
00136	McCoy Electronics Co. Watts-Chestnut St. Mt. Holly Springs, PA 17065	07263	Fairchild Semiconductor A Div. of Fairchild Camera and Instrument Corp. 464 Ellis St. Mountain View, CA 94040
00853	Sangamo Electric Co. South Carolina Div. Pickens, SC 29671	07688	Joint Electron Device Engineering Council
01295	Texas Instruments, Inc. Components Group 13500 N. Central Expressway Dallas, TX 75222	07896	Jadaro Machine Products 325 S. Shiloh Rd. Garland, TX 75040
01526	General Electric Co. Data Communication Products Dept. General Electric Dr. Waynesboro, VA 22980	08289	Blinn, Delbert, Co., The 1678 E. Mission Blvd. Pomona, CA 91766
01884	Dearborn Electronics, Inc. P.O. Box 530 Orlando, FL 32802	08664	Bristol, Div. of American Chain and Cable Co., Inc. 40 Bristol St. Waterbury, CT 06720
02660	Bunker-Ramo Corp., The Amphenol Connector Div. 2801 S. 25th Ave. Broadview, IL 60153	08717	Sloan Co., The 7704 San Fernando Rd. Sun Valley, CA 91352
03038	Long-Lok Corp. 4101 Redwood Ave. Los Angeles, CA 90066	08732	Solid State Products Div. of Unitrode Corp. 1 Pingree St. Salem, MA 01970
03508	General Electric Co. Semi-Conductor Products Dept. Electronics Park Syracuse, NY 13201	08817	Epec Industries, Inc. New Bedford Industrial Park New Bedford, MA 02745
04713	Motorola, Inc. Semiconductor Products Div. 5005 E. McDowell Rd. Phoenix, AZ 85008	09052	Gulton Battery Corp. 312 Durham Ave. Metuchen, NJ 08840
05397	Union Carbide Corp. Materials Systems Div. 11901 Madison Ave. Cleveland, OH 44101	09922	Burndy Corp. Richards Ave. Norwalk, CT 06852
05411	Du Page Mfg. Co. 2250 Curtiss Ave. Downers Grove, IL 60515	10646	Carborundum Co., The P.O. Box 337 Niagara Falls, NY 14302

CODE	MANUFACTURER'S NAME AND ADDRESS	CODE	MANUFACTURER'S NAME AND ADDRESS
11502	I.R.C. Div. of TRW, Inc. Boone Plant Greenway Rd. Boone, NC 28607	17537	Lamps, Inc. 19220 S. Normandie Ave. Torrance, CA 90502
12014	Chicago Rivet and Machine Co. 950 S. 25th Ave. Bellwood, IL 60104	17896	Siliconix, Inc. 2201 Laurelwood Rd. Santa Clara, CA 95050
12040	National Semiconductor Corp. Commerce Dr. 443 Danbury, CT 06810	18324	Signetics Corp. 811 E. Argues Ave. Sunnyvale, CA 94086
12127	Permonite Mfg. Co. 910 W. Jackson Blvd. Chicago, IL 60607	18796	Erie Technological Products, Inc. State College Div. State College, PA 16801
12615	U.S. Terminals, Inc. 7504 Camargo Rd. Cincinnati, OH 45243	19080	Robison Electronics, Inc. 2134 W. Rosecrans Ave. Gardena, CA 90249
13103	Thermalloy Co. 8717 Diplomacy Row Dallas, TX 75247	21242	American Electronic Components Corp. 7516 Camargo Rd. Cincinnati, OH 45243
13499	Collins Radio Company 5225 C Ave. N.E. Cedar Rapids, IA 52406	22229	Solitron Devices, Inc. 8808 Balboa Ave. San Diego, CA 92123
14099	Semtech Corp. 652 Mitchell Rd. Newbury Park, CA 91320	24546	Corning Glass Works 550 High St. Bradford, PA 16701
14208	Minneapolis Speaker Co. 3806 Grand Ave. S. Minneapolis, MN 55409	27014	National Semiconductor Corp. 2950 San Ysidro Way Santa Clara, CA 95051
14655	Cornell-Dubilier Electronics Div. of Federal Pacific Electric Co. Govt Contracts Dept. 150 Ave. L Newark, NJ 07101	27549	Electro Magnetic Components 226 Commercial St. Garland, TX 75040
16546	U.S. Capacitor Corp. 2151 N. Lincoln Burbank, CA 91504	28480	Hewlett-Packard Co. Corporate HQ 1501 Page Mill Rd. Palo Alto, CA 94304
17117	Electronic Molding Corp. 96 Mill St. Woonsocket, RI 02895	29083	Monsanto Co., Inc. 2710 Lafayette Santa Clara, CA 95050



CODE	MANUFACTURER'S NAME AND ADDRESS	CODE	MANUFACTURER'S NAME AND ADDRESS
29593	Bussco Engineering, Inc. 122 Penn St. El Segundo, CA 90245	71785	Cinch Mfg. Co. Div. of TRW, Inc. 1501 Morse Ave. Elk Grove Village, IL 60007
32171	Modutec, Inc. 18 Marshall St. Norwalk, CT 06854	72136	Electro Motive Mfg. Co., Inc., The South Park and John Streets Willimantic, CT 06226
37942	Mallory, P. R.. and Co., Inc. 3029 E. Washington St. Indianapolis, IN 46206	72962	Elastic Stop Nut Div. of Amerace Esna Corp. 2330 Vauxhall Rd. Union, NJ 07083
46384	Penn Engineering and Mfg. Corp. Old Easton Hwy. Doylestown, PA 18901	72982	Erie Technological Products, Inc. 644 W. 12th St. Erie, PA 16512
49956	Raytheon Co. 141 Spring St. Lexington, MA 02173	73138	Beckman Instruments, Inc. Helipot Div. 2500 Harbor Blvd. Fullerton, CA 92634
56289	Sprague Electric Co. North Adams, MA 01247	74921	Iten Fibre Co., The 4001 Benefit Ave. Ashtabula, OH 44004
59730	Thomas and Betts Co., The 36 Butler St. Elizabeth, NJ 07207	75183	Johnson Rubber Co., The 16025 Johnson St. Middlefield, OH 44062
70318	Allmetal Screw Products Co., Inc. 821 Stewart Ave. Garden City, NY 11530	75378	CTS Knights, Inc. 222 Reimann Ave. Sandwich, IL 60548
70674	A.D.C. Products Div. of Magnetic Controls Co. 4900 W. 78th St. Minneapolis, MN 55435	75382	Kulba Electric Corp. 633 - 643 S. Fulton Ave. Mt. Vernon, NY 10550
71400	Bussman Mfg. Div. of McGraw-Edison Co. 2536 W. University St. St. Louis, MO 63017	76381	Minnesota Mining and Mfg. Co. 3M Center St. Paul, MN 55101
71590	Centralab Electronics Div. of Globe-Union, Inc. 5757 N. Green Bay Ave. Milwaukee, WI 53201	76854	Oak Mfg. Co. Div. of Oak Electro/Netics Corp. S. Main St. Crystal Lake, IL 60014
71744	Chicago Miniature Lamp Works 4433 Ravenswood Ave. Chicago, IL 60640		

CODE	MANUFACTURER'S NAME AND ADDRESS	CODE	MANUFACTURER'S NAME AND ADDRESS
77147	Patton-MacGuyer Co. Div. of Avid Corp. 17 Virginia Ave. Providence, RI 02905	80294	Bourns, Inc. 1200 Columbia Ave. Riverside, CA 92507
77250	Pheoll Mfg. Co. Div. of Allied Products Corp. 5700 W. Roosevelt Rd. Chicago, IL 60650	81095	Triad-Utrad Div. Litton Systems, Inc. 4055 Redwood Ave. Venice, CA 90291
77820	Bendix Corp., The Electrical Components Div. Sherman Ave. Sidney, NY 13838	81349	Military Specifications
78189	Illinois Tool Works, Inc. Shakeproof Div. St. Charles Rd. Elgin, IL 60126	81350	Joint Army-Navy Specifications
78526	Stanwyck Winding Div. San Fernando Electric Mfg. Co., Inc. 139 Walsh Ave. Newburgh, NY 12550	81815	Communication Coil Co. 2839 N. Narragansett Ave. Chicago, IL 60634
79136	Waldes Kohinoor, Inc. 47-16 Austel Place Long Island City, NY 11101	82104	Standard Grigsby Co. 920 Rathbone Ave. Aurora, IL 60507
79727	C-W Industries 550 Davisville Rd. Warminster, PA 18974	82389	Switchcraft, Inc. 5555 N. Elston Ave. Chicago, IL 60630
79807	Wrought Washer Mfg. Co. 2100 S. Bay St. Milwaukee, WI 53207	82647	Texas Instruments, Inc. Control Products Div. 34 Forest St. Attleboro, MA 02703
79963	Zierick Mfg. Co. Radio Circle Mt. Kisco, NY 10549	82877	Rotron, Inc. 7-9 Hasbrouck Lane Woodstock, NY 12498
80033	Prestole Everlock, Inc. 1345 Miami St. Toledo, OH 43605	83058	Carr Fastener Co. 238 Main St. Cambridge, MA 02142
80058	Joint Electronic Type Designation System	86577	Precision Metal Products of Malden, Inc. 41 Elm St. Stoneham, MA 02180
		86928	Seastrom Mfg. Co., Inc. 701 Sonora Ave. Glendale, CA 91201
		88044	Aeronautical Standards Group Dept. of Navy and Air Force Silver Springs, MD 20900

CODE	MANUFACTURER'S NAME AND ADDRESS	CODE	MANUFACTURER'S NAME AND ADDRESS
88245	Litton Precision Products, Inc. Useco Div. Litton Industries 13536 Saticoy St. Van Nuys, CA 91409	95354	Method Manufacturing Corp. 1700 S. Hicks Rd. Rolling Meadows, IL 60008
90030	USM Corp. USM Machinery Div. 181 Elliott St. Beverly, MA 01915	96214	Texas Instruments, Inc. Government Products Div. of Equip. Group 13510 N. Central Expressway Dallas, TX 75222
90484	ITT Surprenant Div. Clinton, MA 01510	96733	San Fernando Electric Mfg. Co. 1501 - 1st St. San Fernando, CA 91341
90634	Gulton Industries, Inc. Gulton St. Metuchen, NJ 08840	96906	Military Standards
91637	Dale Electronics, Inc. P.O. Box 609 Columbus, NB 68601	98278	Microdot, Inc. 220 Pasadena Ave. South Pasadena, CA 91030
91886	Malco Mfg. Co., Inc. 5150 W. Roosevelt Rd. Chicago, IL 60650	98291	Sealectro Corp. 225 Hoyt Mamaroneck, NY 10544
93332	Sylvania Electric Products, Inc. Semiconductor Products Div. 100 Sylvan Rd. Woburn, MA 01801	99378	Atlee Corp. 2 Lowell Ave. Winchester, MA 01890
94988	Wagner Electric Corp. Tung-sol Div. 630 W. Mt. Pleasant Ave. Livingston, NJ 07039	99800	Delevan Div. American Precision Industries, Inc. 270 Quaker Rd. East Aurora, NY 14052

### 1.6 Usage Codes

The following usage codes have been assigned in this manual:

<u>USAGE CODE</u>	<u>P/N</u>	<u>DESCRIPTION</u>	<u>CI</u>	<u>FIG</u>
A	522-4836-102	651S-1 General Purpose HF Receiver	72465	1
B	522-4836-103	651S-1 General Purpose HF Receiver	72413	1
C	522-4836-104	651S-1 General Purpose HF Receiver	72413	1
D	522-4836-106	651S-1 General Purpose HF Receiver	72413	1
E	522-4836-107	651S-1 General Purpose HF Receiver	72413	1
F	522-4836-108	651S-1 General Purpose HF Receiver	72413	1

<u>USAGE CODE</u>	<u>P/N</u>	<u>DESCRIPTION</u>	<u>CI</u>	<u>FIG</u>
G	522-4836-110	651S-1 General Purpose HF Receiver	72413	1
H	522-4836-111	651S-1 General Purpose HF Receiver	72413	1
J	522-4836-120	651S-1 General Purpose HF Receiver	72413	1
K	522-4836-121	651S-1 General Purpose HF Receiver	72413	1
L	522-4836-122	651S-1 General Purpose HF Receiver	72413	1
M	522-4836-123	651S-1 General Purpose HF Receiver	72413	1
N	522-4836-004	651S-1 General Purpose HF Receiver	73026	1
P	522-4836-129	651S-1 General Purpose HF Receiver	73013	1
Q	522-4836-131	651S-1 General Purpose HF Receiver	72504	1
R	790-1048-008	RF Module (A6)	72263	16
S	790-1048-010	RF Module (A6)	72314	16
T	778-2934-002	Diode Switching Card (P/o A6)	71475	17
U	778-2934-003	Diode Switching Card (P/o A6)	71496	17
V	609-0552-001	Variable Beat Frequency Oscillator (A2A1)	73024	32
W	609-0552-002	Variable Beat Frequency Oscillator (A2A1)	73024	32
X	522-4836-113	651S-1 General Purpose HF Receiver	72413	1
Y	522-4836-124	651S-1 General Purpose HF Receiver	72413	1
Z	522-4836-125	651S-1 General Purpose HF Receiver	72413	1
AA	522-4836-126	651S-1 General Purpose HF Receiver	72403	1
AB	522-4836-128	651S-1 General Purpose HF Receiver	72396	1
AC	522-4836-152	651S-1 General Purpose HF Receiver	73095	1
AD	522-4836-153	651S-1 General Purpose HF Receiver	72396	1
AE	522-4836-156	651S-1 General Purpose HF Receiver	72396	1
AF	522-4836-173	651S-1 General Purpose HF Receiver	72396	1
AG	622-1062-001	651S-1A General Purpose HF Receiver	73086	1
AH	618-7705-001	Variable Beat Frequency Oscillator (A2A1)	73024	33
AJ	618-7705-002	Variable Beat Frequency Oscillator (A2A1)	73024	33
AK	778-2924-004	Interconnect Card (A8)	72346	13
AL	778-2924-006	Interconnect Card (A8)	72353	13
AM	522-4836-132	651S-1 General Purpose HF Receiver	72504	1
AN	522-4836-133	651S-1 General Purpose HF Receiver	72504	1
AP	522-4836-134	651S-1 General Purpose HF Receiver	73023	1
AQ	522-4836-135	651S-1 General Purpose HF Receiver	73046	1
AR	522-4836-154	651S-1 General Purpose HF Receiver	73014	1
AS	522-4836-179	651S-1 General Purpose HF Receiver	72516	1

<u>USAGE CODE</u>	<u>P/N</u>	<u>DESCRIPTION</u>	<u>CI</u>	<u>FIG</u>
AT	522-4836-180	651S-1 General Purpose HF Receiver	72504	1
AU	522-4836-181	651S-1 General Purpose HF Receiver	72505	1
AV	522-4836-182	651S-1 General Purpose HF Receiver	72505	1
AW	522-4836-183	651S-1 General Purpose HF Receiver	72516	1
AX	522-4836-184	651S-1 General Purpose HF Receiver	72516	1
AY	797-3571-001	IF Filter Card (A5A1)	73076	19
AZ	797-3571-006	IF Filter Card (A5A1)	73046	19
BA	797-3571-007	IF Filter Card (A5A1)	73076	19
BB	797-3571-010	IF Filter Card (A5A1)	73076	19
BC	797-3571-011	IF Filter Card (A5A1)	73076	19
BD	797-3571-012	IF Filter Card (A5A1)	73076	19
BE	797-3585-002	IF Filter Card (A5A2)	73026	20
BF	797-3585-003	IF Filter Card (A5A2)	73026	20
BG	797-3585-010	IF Filter Card (A5A2)	73026	20
BH	797-3585-011	IF Filter Card (A5A2)	73026	20
BJ	797-3585-012	IF Filter Card (A5A2)	73026	20
BK	778-2951-001	IF Amplifier Card (A4)	72486	21
BL	778-2951-003	IF Amplifier Card (A4)	72486	21
BM	778-2951-004	IF Amplifier Card (A4)	72486	21
BN	778-2948-003	Audio Amplifier Card (A2)	72373	23
BP	778-2948-005	Audio Amplifier Card (A2)	72396	23
BQ	778-2948-002	Audio Amplifier Card (A2)	72373	25
BR	778-2948-004	Audio Amplifier Card (A2)	72465	25
BS	606-9423-003	Receiver Chassis	72173	26
BT	606-9423-005	Receiver Chassis	72274	26
BU	606-9423-006	Receiver Chassis	72354	26
BV	606-9423-007	Receiver Chassis	72323	26
BW	606-9423-009	Receiver Chassis	72516	26
BX	790-1048-020	RF Module (A6)	73074	36
BY	790-1048-021	RF Module (A6)	73074	36
BZ	618-7678-001	Filter/Diode Switch (A6A2)	73045	38
CA	618-7678-002	Filter/Diode Switch (A6A2)	73045	38
CB	606-9425-003	Front Panel	73073	39
CC	606-9425-004	Front Panel	73073	39
CD	606-9425-005	Front Panel	73073	39

<u>USAGE CODE</u>	<u>P/N</u>	<u>DESCRIPTION</u>	<u>CI</u>	<u>FIG</u>
CE	606-9424-002	Radio Receiver Power Supply	72434	40
CF	606-9424-004	Radio Receiver Power Supply	73346	40
CG	606-9424-005	Radio Receiver Power Supply	72434	40
CH	606-9424-006	Radio Receiver Power Supply	73095	40
CJ	778-2924-007	Interconnect Card (A8)	73075	13

### *1.7 Reference Designation Prefixes*

The following prefixes have been assigned in this manual:

<u>PREFIX</u>	<u>P/N</u>	<u>DESCRIPTION</u>	<u>CI</u>	<u>FIG</u>
A1	778-2949-001	Power Supply Regulator Card	73116	24
A2	778-2948-003	Audio Amplifier Card	73116	23
A2	778-2948-005	Audio Amplifier Card	72396	23
A2	778-2948-002	Audio Amplifier Card	72373	25
A2	778-2948-004	Audio Amplifier Card	72465	25
A2A1	609-0552-001	Variable Beat Frequency Oscillator	73024	32
A2A1	609-0552-002	Variable Beat Frequency Oscillator	73024	32
A2A1	618-7705-001	Variable Beat Frequency Oscillator	73024	33
A2A1	618-7705-002	Variable Beat Frequency Oscillator	73024	33
A3	778-2952-001	ISB Card	73046	22
A4	778-2951-001	IF Amplifier Card	72486	21
A4	778-2951-003	IF Amplifier Card	73156	21
A4	778-2951-004	IF Amplifier Card	72486	21
A5A1	797-3571-001	IF Filter Card	73076	19
A5A1	797-3571-006	IF Filter Card	73046	19
A5A1	797-3571-007	IF Filter Card	73076	19
A5A1	797-3571-010	IF Filter Card	73076	19
A5A1	797-3571-011	IF Filter Card	73136	19
A5A1	797-3571-012	IF Filter Card	73076	19
A5A2	797-3585-002	IF Filter Card	73026	20
A5A2	797-3585-003	IF Filter Card	73026	20
A5A2	797-3585-010	IF Filter Card	73026	20
A5A2	797-3585-011	IF Filter Card	73026	20
A5A2	797-3585-012	IF Filter Card	73026	20
A6	790-1048-008	RF Module	72263	16

<u>PREFIX</u>	<u>P/N</u>	<u>DESCRIPTION</u>	<u>CI</u>	<u>FIG</u>
A6	790-1048-010	RF Module	72314	16
A6	790-1048-020	RF Module	73096	36
A6	790-1048-021	RF Module	73074	36
A6A1	618-3258-001	RF Mixer	73074	37
A6A2	618-7678-001	Filter/Diode Switch	73045	38
A6A2	618-7678-002	Filter/Diode Switch	73045	38
A7	778-2928-003	Decoder/Driver Card	73046	15
A7	608-9087-001	Decoder/Driver Card	73012	34
A7	608-9121-001	Decoder/Driver Card	73033	35
A8	778-2924-004	Interconnect Card	72346	13
A8	778-2924-006	Interconnect Card	72353	13
A8	778-2924-007	Interconnect Card	73075	13
A8	624-5744-001	Interconnect Card	73166	14
A9	774-7842-001	DCU Card	72523	4
A9	793-9414-001	DCU Card	72473	11
A9	783-9480-001	TCU Card	73083	12
A9	624-5781-001	DCU Card	72393	31
A9	783-9368-001	Auto Scan Control Card	72503	41
A10	793-9334-002	Synthesizer Divider Card	73033	8
A10	793-9334-006	Synthesizer Divider Card	73033	9
A11	793-9333-002	Synthesizer Reference Card	73466	6
A12	793-9332-002	Synthesizer Mixer Card	72296	5
A13	793-9331-003	Synthesizer VCO Card	73316	3
A14	783-9283-001	Frequency Control Card	72313	2

### *1.8 Configuration Identifiers*

The following CI's were used in compiling data for this manual:

<u>CI</u>	<u>P/N</u>	<u>DESCRIPTION</u>	<u>FIG - ITEM</u>
71134	606-9422-002	Cover	1-1
69011	785-2881-001	Resistor Kit	3- 3-11 3-31
72121	624-3524-001	Resistor Kit	6-3 6-34
69011	785-2797-001	Resistor Kit	14-153

<u>CI</u>	<u>P/N</u>	<u>DESCRIPTION</u>	<u>FIG - ITEM</u>
72443	606-9880-002	Electronic Component Assy	16-2
72323	606-9880-003	Electronic Component Assy	16-2
71483	609-1640-001	Filter Bracket	16-4
72124	790-2017-001	Filter Bracket	16-4
72165	790-1393-004	Filter Network	16-18
72274	790-1393-005	Filter Network	16-18
72343	609-1644-001	Antenna Switch	16-64 36-26A
73134	609-1642-001	Relay Bracket	16-75
72176	606-9877-002	RF Mixer	16-83
72336	609-1653-001	Shield No. 2	16-183
72163	609-1652-001	Shield No. 1	16-207
72165	606-9879-002	Filter Network	16-226 36-11
72266	606-9879-003	Filter Network	16-226
72173	609-1631-001	RF Module Chassis	16-241
73053	609-1643-001	VLF Mixer	18-
72333	609-1641-001	VLF Mixer Chassis	18-60
73046	608-9278-001	Resistor Kit	19-70 19-193
73173	606-9426-002	Center Chassis	26-15
72115	609-1648-001	Coax Cable Assy	26-70
72115	609-1647-001	Junction Box	26-74
73046	778-2950-002	Printed Wiring Board	26-78
72284	609-0928-001	Keep-Alive Power Switch	27-
72163	606-9884-001	IF Blanker	28-
72323	606-9885-001	IF Blanker Chassis	28-14
72323	606-9708-001	Audio Amplifier	29-
71325	606-9886-001	Terminal Board TB104	29-35
73133	618-7105-001	Electronic Component Box	30-
72265	618-7104-001	Terminal Board TB104	30-42
71064	609-0551-001	Oscillator Chassis	32-119
72173	609-0551-002	Oscillator Chassis	32-119
72383	618-7704-001	Oscillator Chassis	33-106
72433	606-9879-004	Filter Network	36-11
72505	606-9879-005	Filter Network	36-11



<u>CI</u>	<u>P/N</u>	<u>DESCRIPTION</u>	<u>FIG - ITEM</u>
72365	618-3260-001	Filter Network	36-27
72505	618-3260-002	Filter Network	36-27
72194	609-1631-001	RF Module Chassis	36-53
72483	618-3257-001	Chassis Plate	37-154
73045	618-7677-001	Filter Bracket	38-54
72203	606-9705-001	Meter Assy	39-5
72323	606-9705-002	Meter Assy	39-5
72403	609-0553-002	Wiring Harness	39-17
72403	609-0553-003	Wiring Harness	39-17
72403	609-0553-004	Wiring Harness	39-17
72376	606-9706-002	Toggle Switch Assy	39-28
72165	606-9710-003	Resistor Component Assy	39-36
72423	606-9710-004	Resistor Component Assy	39-36
72284	606-9707-002	Indicator Housing	39-73
72323	609-0550-001	Electronic Component Assy	40-18
72114	609-0549-001	Electronic Component Assy	40-38
72354	609-0549-002	Electronic Component Assy	40-38
72216	606-9870-002	Power Supply Chassis	40-65
73034	792-6980-001	699J-1 Receiver Adapter	42-
71136	609-0307-001	Retainer Assy	42-2
71136	609-0307-002	Retainer Assy	42-5
72053	609-0561-001	Panel Assy	42-8
71206	609-0560-001	Adapter	42-14

2. GROUP ASSEMBLY PARTS LIST

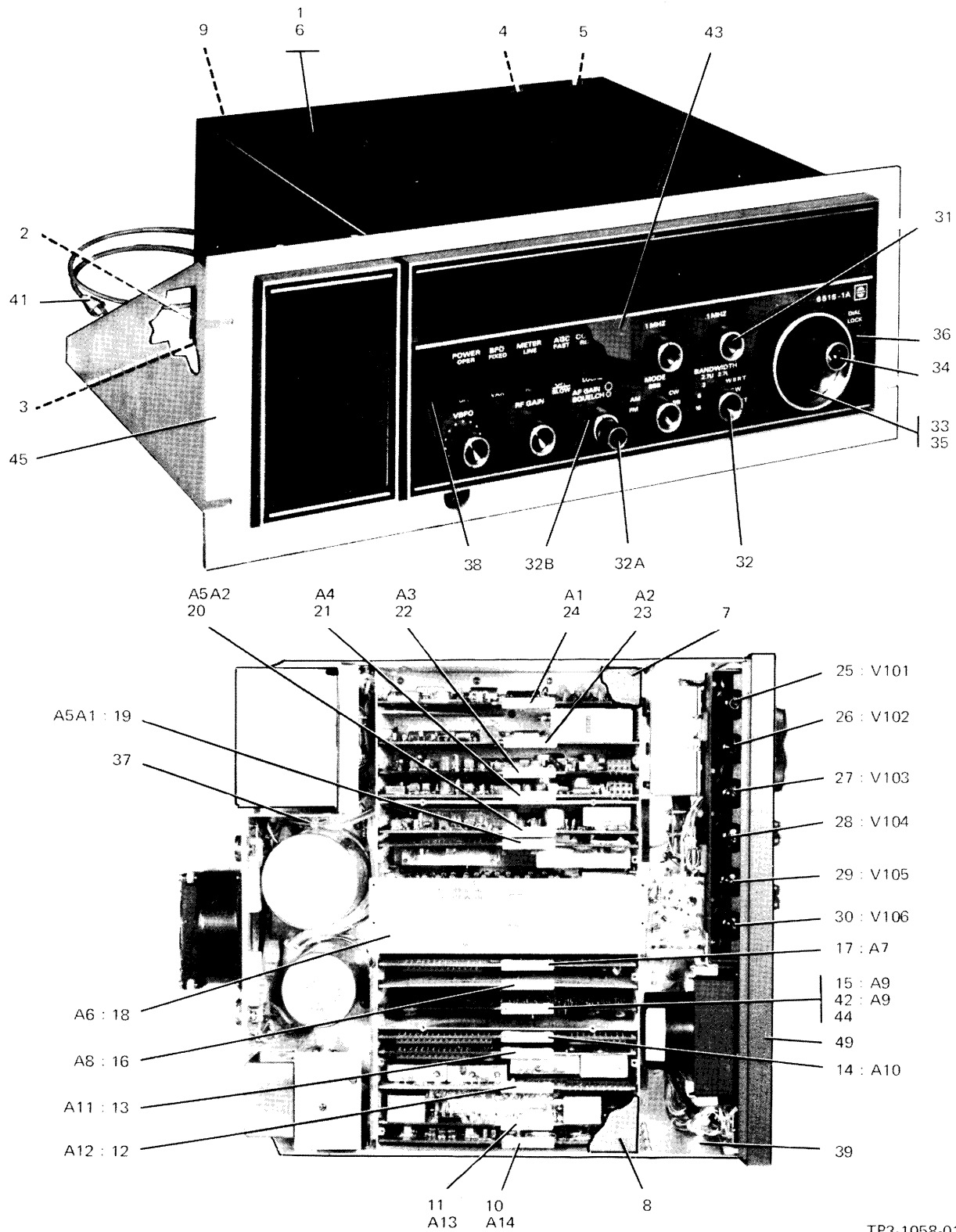

TP3-1058-017

651S-1/1A General Purpose HF Receiver  
Figure 1

GROUP ASSEMBLY PARTS LIST

FIG - ITEM	PART NO	INDENT	DESCRIPTION	USABLE ON CODE	UNITS PER ASSY
1 -	522-4836-102	1	RECEIVER, HF, GENERAL PURPOSE, 651S-1	A	1
-	522-4836-103	1	RECEIVER, HF, GENERAL PURPOSE, 651S-1	B	1
-	522-4836-104	1	RECEIVER, HF, GENERAL PURPOSE, 651S-1	C	1
-	522-4836-106	1	RECEIVER, HF, GENERAL PURPOSE, 651S-1	D	1
-	522-4836-107	1	RECEIVER, HF, GENERAL PURPOSE, 651S-1	E	1
-	522-4836-108	1	RECEIVER, HF, GENERAL PURPOSE, 651S-1	F	1
-	522-4836-110	1	RECEIVER, HF, GENERAL PURPOSE, 651S-1	G	1
-	522-4836-111	1	RECEIVER, HF, GENERAL PURPOSE, 651S-1	H	1
-	522-4836-120	1	RECEIVER, HF, GENERAL PURPOSE, 651S-1	J	1
-	522-4836-121	1	RECEIVER, HF, GENERAL PURPOSE, 651S-1	K	1
-	522-4836-122	1	RECEIVER, HF, GENERAL PURPOSE, 651S-1	L	1
-	522-4836-123	1	RECEIVER, HF, GENERAL PURPOSE, 651S-1	M	1
-	522-4836-004	1	RECEIVER, HF, GENERAL PURPOSE, 651S-1	N	1
-	522-4836-129	1	RECEIVER, HF, GENERAL PURPOSE, 651S-1	P	1
-	522-4836-131	1	RECEIVER, HF, GENERAL PURPOSE, 651S-1	Q	1
-	522-4836-113	1	RECEIVER, HF, GENERAL PURPOSE, 651S-1	X	1
-	522-4836-124	1	RECEIVER, HF, GENERAL PURPOSE, 651S-1	Y	1
-	522-4836-125	1	RECEIVER, HF, GENERAL PURPOSE, 651S-1	Z	1
-	522-4836-126	1	RECEIVER, HF, GENERAL PURPOSE, 651S-1	AA	1
-	522-4836-128	1	RECEIVER, HF, GENERAL PURPOSE, 651S-1	AB	1
-	522-4836-152	1	RECEIVER, HF, GENERAL PURPOSE, 651S-1	AC	1
-	522-4836-153	1	RECEIVER, HF, GENERAL PURPOSE, 651S-1	AD	1
-	522-4836-156	1	RECEIVER, HF, GENERAL PURPOSE, 651S-1	AE	1
-	522-4836-173	1	RECEIVER, HF, GENERAL PURPOSE, 651S-1	AF	1
-	622-1062-001	1	RECEIVER, HF, GENERAL PURPOSE, 651S-1A	AG	1
-	522-4836-132	1	RECEIVER, HF, GENERAL PURPOSE, 651S-1	AM	1
-	522-4836-133	1	RECEIVER, HF, GENERAL PURPOSE, 651S-1	AN	1
-	522-4836-134	1	RECEIVER, HF, GENERAL PURPOSE, 651S-1	AP	1
-	522-4836-135	1	RECEIVER, HF, GENERAL PURPOSE, 651S-1	AQ	1
-	522-4836-154	1	RECEIVER, HF, GENERAL PURPOSE, 651S-1	AR	1
-	522-4836-179	1	RECEIVER, HF, GENERAL PURPOSE, 651S-1	AS	1
-	522-4836-180	1	RECEIVER, HF, GENERAL PURPOSE, 651S-1	AT	1
-	522-4836-181	1	RECEIVER, HF, GENERAL PURPOSE, 651S-1	AU	1
-	522-4836-182	1	RECEIVER, HF, GENERAL PURPOSE, 651S-1	AV	1
-	522-4836-183	1	RECEIVER, HF, GENERAL PURPOSE, 651S-1	AW	1
-	522-4836-184	1	RECEIVER, HF, GENERAL PURPOSE, 651S-1	AX	1
1	606-9422-002	2	COVER		1
	MS51957-26	2	SCREW, MACH, SST, 6-32 X 1/4 (V96906) 343-0167-000 (AP)		2
2	SJ5112	3	BUMPER, ADH, (V76381) 200-1122-010		2
3	609-0494-001	3	GASKET		1
4	609-0494-002	3	GASKET		2
5	609-0495-001	3	GASKET		2
6	609-0543-001	3	COVER		1
7	606-9867-001	2	COVER, TOP, RIGHT		1
8	606-9868-001	2	COVER, TOP, LEFT		1
	MS51957-12	2	SCREW, MACH, STL, 4-40 X 3/16 (V96906) 343-0132-000 (AP FOR 7,8)		12
	MS51957-15	2	SCREW, MACH, STL, 4-40 X 3/8 (V96906) 343-0135-000 (AP FOR 7,8)		4
9	778-6742-000	2	PLATE, IDENT		1
10	783-9283-001	2	CIRCUIT CARD ASSY, FREQUENCY CONTROL A14 (SEE FIG 2)		1
11	793-9331-003	2	CIRCUIT CARD ASSY, SYNTHESIZER VCO A13 (SEE FIG 3)		1
12	793-9332-002	2	CIRCUIT CARD ASSY, SYNTHESIZER MIXER A12 (SEE FIG 5)		1
13	793-9333-002	2	CIRCUIT CARD ASSY, SYNTHESIZER REFERENCE A11 (SEE FIG 6)		1

GROUP ASSEMBLY PARTS LIST

FIG - ITEM	PART NO	INDENT	DESCRIPTION	USABLE ON CODE	UNITS PER ASSY
1 14	793-9334-002	2	CIRCUIT CARD ASSY, SYNTHESIZER DIVIDER A10 (SEE FIG 8)	A,B,C,D E,F,G,H K,L,M,N P,Q,X,Y Z,AA,AB AC,AD,AE AF,AG,AP AR,AS,AT AU,AW,AX	1
14	793-9334-006	2	CIRCUIT CARD ASSY, SYNTHESIZER DIVIDER A10 (SEE FIG 9)	J,AM,AN AQ,AV	1
15	793-9414-001	2	CIRCUIT CARD ASSY, DCU A9 (SEE FIG 11)	B,E,F,P X,Z AB	1
15	783-9480-001	2	CIRCUIT CARD ASSY, YCU A9 (SEE FIG 12)	M	1
15	624-5781-001	2	CIRCUIT CARD ASSY, DCU A9 (SEE FIG 31)	AF	
15	774-7842-001	2	CIRCUIT CARD ASSY, DCU A9 (SEE FIG 4)	AD,AW,AX	1
16	778-2924-004	2	CIRCUIT CARD ASSY, INTERCONNECT A8 (SEE FIG 13)	AS	1
				A,D,G,H J,K,L,Y AA,AC,AE AM,AN,AP B,E,F,M P,Q,X,Z AB,AC,AF AQ,AS,AW AX	1
16	624-5744-001	2	CIRCUIT CARD ASSY, DCFE A8 (SEE FIG 14)	C,N	1
16	778-2924-006	2	CIRCUIT CARD ASSY, INTERCONNECT A8 (SEE FIG 13)	AG,AR	
16	778-2924-007	2	CIRCUIT CARD ASSY, INTERCONNECT A8 (SEE FIG 13)	AT,AU,AV	1
17	778-2928-003	2	CIRCUIT CARD ASSY, DECODER/DRIVER A7 (SEE FIG 15)	A,B,C,D E,F,G,H J,K,L,M P,Q,X,Y Z,AA,AB AM,AN,AP AQ	1
17	608-9121-001	2	CIRCUIT CARD ASSY, DECODER/DRIVER A7 (SEE FIG 35)	N	1
17	608-9087-001	2	CIRCUIT CARD ASSY, DECODER/DRIVER A7 (SEE FIG 34)	AG,AW AC,AD,AE AF,AR,AS AT,AU,AV AX	1
18	790-1048-008	2	MODULE ASSY, RF A6 (SEE FIG 16)	A,B,C,D E,F,G,H K,L,M,P Q,X,Y,Z AA,AR,AP	1
18	790-1048-010	2	MODULE ASSY, RF A6 (SEE FIG 16)	J	1
18	790-1048-020	2	MODULE ASSY, RF A6 (SEE FIG 36)	AM,AN,AQ N,AC,AD AE,AF,AG AR,AS,AT AU,AW,AX AV	1
18	790-1048-021 MS51957-15	2	MODULE ASSY, RF, A6 (SEE FIG 36)		1
		2	SCREW, MACH, STL, 4-40 X 3/8 (V96906) 343-0135-000 (AP)		4
	MS35338-135	2	WASHER, LOCK, SST, 0.115 ID X 0.209 OD (V96906) 310-0279-000 (AP)		4
19	797-3571-001	2	CIRCUIT CARD ASSY, IF FILTER A5A1 (SEE FIG 19)	A,B,C,D E,F,G,H J,K,L,M P,Q,X,Y Z,AA,AM AN,AP,AQ	1

GROUP ASSEMBLY PARTS LIST

FIG - ITEM	PART NO	INDENT	DESCRIPTION	USABLE ON CODE	UNITS PER ASSY
1	19	797-3571-006	2 CIRCUIT CARD ASSY, IF FILTER A5A1 (SEE FIG 19)	N	1
	19	797-3571-007	2 CIRCUIT CARD ASSY, IF FILTER A5A1 (SEE FIG 19)	AG	
	19	797-3571-010	2 CIRCUIT CARD ASSY, IF FILTER A5A1 (SEE FIG 19)	AB,AX	1
	19	797-3571-011	2 CIRCUIT CARD ASSY, IF FILTER A5A1 (SEE FIG 19)	AC,AD,AE	1
	19	797-3571-012	2 CIRCUIT CARD ASSY, IF FILTER A5A1 (SEE FIG 19)	AF,AS	
	19	797-3571-012	2 CIRCUIT CARD ASSY, IF FILTER A5A1 (SEE FIG 19)	AT,AU,AV	1
	20	797-3585-002	2 CIRCUIT CARD ASSY, IF FILTER A5A2 (SEE FIG 20)	AW	
	20	797-3585-003	2 CIRCUIT CARD ASSY, IF FILTER A5A2 (SEE FIG 20)	AR	1
	20	797-3585-010	2 CIRCUIT CARD ASSY, IF FILTER A5A2 (SEE FIG 20)	C	1
	20	797-3585-011	2 CIRCUIT CARD ASSY, IF FILTER A5A2 (SEE FIG 20)	E,F,G,H	1
	20	797-3585-012	2 CIRCUIT CARD ASSY, IF FILTER A5A2 (SEE FIG 20)	K,L,Q,Y	
	20	797-3585-012	2 CIRCUIT CARD ASSY, IF FILTER A5A2 (SEE FIG 20)	AM,AN,AQ	
	20	797-3585-012	2 CIRCUIT CARD ASSY, IF FILTER A5A2 (SEE FIG 20)	AW	
	20	797-3585-011	2 CIRCUIT CARD ASSY, IF FILTER A5A2 (SEE FIG 20)	N	1
	20	797-3585-012	2 CIRCUIT CARD ASSY, IF FILTER A5A2 (SEE FIG 20)	AG,AP,AR	
	20	797-3585-012	2 CIRCUIT CARD ASSY, IF FILTER A5A2 (SEE FIG 20)	AB,AX	1
	20	797-3585-012	2 CIRCUIT CARD ASSY, IF FILTER A5A2 (SEE FIG 20)	P	1
	21	778-2951-001	2 CIRCUIT CARD ASSY, IF AMPLIFIER A4 (SEE FIG 21)	AT,AU,AV	
	21	778-2951-003	2 CIRCUIT CARD ASSY, IF AMPLIFIER A4 (SEE FIG 21)	A,B,C,D	1
	21	778-2951-004	2 CIRCUIT CARD ASSY, IF AMPLIFIER A4 (SEE FIG 21)	E,F,G,H	
	21	778-2951-004	2 CIRCUIT CARD ASSY, IF AMPLIFIER A4 (SEE FIG 21)	J,K,L,M	
	21	778-2951-004	2 CIRCUIT CARD ASSY, IF AMPLIFIER A4 (SEE FIG 21)	P,Q,Y,Z	
	21	778-2951-004	2 CIRCUIT CARD ASSY, IF AMPLIFIER A4 (SEE FIG 21)	AA,AB,AM	
	21	778-2951-004	2 CIRCUIT CARD ASSY, IF AMPLIFIER A4 (SEE FIG 21)	AN,AP,AQ	
	21	778-2951-004	2 CIRCUIT CARD ASSY, IF AMPLIFIER A4 (SEE FIG 21)	X	1
	21	778-2951-004	2 CIRCUIT CARD ASSY, IF AMPLIFIER A4 (SEE FIG 21)	AW,AX	
	21	778-2951-004	2 CIRCUIT CARD ASSY, IF AMPLIFIER A4 (SEE FIG 21)	N,AC,AD	1
	21	778-2951-004	2 CIRCUIT CARD ASSY, IF AMPLIFIER A4 (SEE FIG 21)	AE,AF,AG	
	21	778-2951-004	2 CIRCUIT CARD ASSY, IF AMPLIFIER A4 (SEE FIG 21)	AR,AS,AT	
	21	778-2951-004	2 CIRCUIT CARD ASSY, IF AMPLIFIER A4 (SEE FIG 21)	AU,AV	
	22	778-2952-001	2 CIRCUIT CARD ASSY, ISB A3 (SEE FIG 22)	D,E,G,L	1
	22	778-2952-001	2 CIRCUIT CARD ASSY, ISB A3 (SEE FIG 22)	Q,AE,AN	
	22	778-2952-001	2 CIRCUIT CARD ASSY, ISB A3 (SEE FIG 22)	AQ,AU	
	23	778-2948-003	2 CIRCUIT CARD ASSY, AUDIO AMPLIFIER A2 (SEE FIG 23)	A,B,C,D	1
	23	778-2948-003	2 CIRCUIT CARD ASSY, AUDIO AMPLIFIER A2 (SEE FIG 23)	E,F,G,H	
	23	778-2948-003	2 CIRCUIT CARD ASSY, AUDIO AMPLIFIER A2 (SEE FIG 23)	J,M,P,X	
	23	778-2948-003	2 CIRCUIT CARD ASSY, AUDIO AMPLIFIER A2 (SEE FIG 23)	AA,AC,AD	
	23	778-2948-003	2 CIRCUIT CARD ASSY, AUDIO AMPLIFIER A2 (SEE FIG 23)	AE,AF,AM	
	23	778-2948-003	2 CIRCUIT CARD ASSY, AUDIO AMPLIFIER A2 (SEE FIG 23)	AN,AP,AR	
	23	778-2948-003	2 CIRCUIT CARD ASSY, AUDIO AMPLIFIER A2 (SEE FIG 23)	AS,AT,AU	
	23	778-2948-003	2 CIRCUIT CARD ASSY, AUDIO AMPLIFIER A2 (SEE FIG 23)	AV,AW	
	23	778-2948-002	2 CIRCUIT CARD ASSY, AUDIO AMPLIFIER A2 (SEE FIG 25)	K,L,Q,Y	1
	23	778-2948-004	2 CIRCUIT CARD ASSY, AUDIO AMPLIFIER A2 (SEE FIG 25)	Z	
	23	778-2948-005	2 CIRCUIT CARD ASSY, AUDIO AMPLIFIER A2 (SEE FIG 23)	AQ	
	23	778-2948-005	2 CIRCUIT CARD ASSY, AUDIO AMPLIFIER A2 (SEE FIG 23)	N	1
	23	778-2948-005	2 CIRCUIT CARD ASSY, AUDIO AMPLIFIER A2 (SEE FIG 23)	AG	
	23	778-2948-005	2 CIRCUIT CARD ASSY, AUDIO AMPLIFIER A2 (SEE FIG 23)	AB,AX	1
	24	778-2949-001	2 CIRCUIT CARD ASSY, POWER SUPPLY REGULATOR A1 (SEE FIG 24)		1
	25	DT1704C	2 ELECTRON TUBE, (V94988) 262-1313-010 V101		1
	26	DT1704C	2 ELECTRON TUBE, (V94988) 262-1313-010 V102		1
	27	DT1704C	2 ELECTRON TUBE, (V94988) 262-1313-010 V103		1
	28	DT1704C	2 ELECTRON TUBE, (V94988) 262-1313-010 V104		1
	29	DT1704C	2 ELECTRON TUBE, (V94988) 262-1313-010 V105		1
	30	DT1704C	2 ELECTRON TUBE, (V94988) 262-1313-010 V106		1
	31	790-2235-002	2 KNOB	A,B,C,D	2
	31	790-2235-002	2 KNOB, (EFF TO CI 72413)	E,F,G,H	
	31	790-2235-002	2 KNOB, (EFF TO CI 72413)	J,K,L,M	
	31	790-2235-002	2 KNOB, (EFF TO CI 72413)	P,Q,X,Y	
	31	790-2235-002	2 KNOB, (EFF TO CI 72413)	Z,AA,AB	
	31	790-2235-002	2 KNOB, (EFF TO CI 72413)	AD,AE,AF	
	31	790-2235-002	2 KNOB, (EFF TO CI 72413)	AG,AM	
	31	790-2235-002	2 KNOB, (EFF TO CI 72413)	AN,AP,AQ	
	31	790-2235-002	2 KNOB, (EFF TO CI 72413)	N	2
	31	790-2235-002	2 KNOB, (EFF TO CI 72413)	AC	

GROUP ASSEMBLY PARTS LIST

FIG - ITEM	PART NO	INDENT	DESCRIPTION	USABLE ON CODE	UNITS PER ASSY
1 32	790-2235-001	2	KNOB	A,B,C,D E,F,G,H J,M,P,X AA,AB,AD AE,AF,AM AN,AP	5
32	790-2235-001	2	KNOB	K,L,Q,Y Z AG,AQ	4
32	790-2235-001	2	KNOB, (EFF TO CI 72413)	N	4
32	790-2235-001	2	KNOB, (EFF CI 72413)	N	6
32	790-2235-001	2	KNOB, (EFF TO CI 72413)	AC	5
32	790-2235-001	2	KNOB, (EFF CI 72413)	AC	7
32	790-2235-001	2	KNOB	AR,AS,AT AU,AV,AW AX	7
	AN565D4L2	2	SETSCREW, CD PL STL, 4-40 X 1/8 (V96906) 328-0371-000 (AP FOR 31,32)	A,B,C,D E,F,G,H J,M,P,X AA,AB,AC AD,AE,AF AM,AN,AP AR,AS,AT AU,AV,AW AX	14
	AN565D4L2	2	SETSCREW, CD PL STL, 4-40 X 1/8 (V96906) 328-0371-000 (AP FOR 31,32)	K,L,N,Q Y,Z AG,AQ	12
32A	790-2235-004	2	KNOB	K,L,N,Q Y,Z AG,AQ	1
32B	790-2235-003	2	KNOB	K,L,N,Q Y,Z AG,AQ	1
	AN565D4L2	2	SETSCREW, CD PL STL, 4-40 X 1/8 (V96906) 328-0371-000 (AP FOR 32A,32B)	K,L,N,Q Y,Z AG,AQ	4
33	606-9406-001	2	KNOB ASSY, TUNE		1
	M551963-114	2	SETSCREW, CD PL STL, 4-40 X 1/4 (V96906) 328-0435-000 (AP)		2
34	606-9404-001	3	CUP		1
	5555-18MD	3	RING, RTNG, (V79136) 340-0269-000 (AP)		1
35	606-9405-001	3	KNOB		1
36	609-0547-001	2	KNOB		1
37	024-0057-000	2	KEY, SKT SCR, (V08664) 024-0057-000 (EFF TO CI 72215)	A,B,C,D E,F,G,H J,K,L,M N,Y,Z AA	1
37	S060CADPL	2	KEY, SCH SCR, (V08664) 024-2900-000 (EFF CI 72215)	A,B,C,D E,F,G,H J,K,L,M N,Y,Z AA	1
37	S060CADPL	2	KEY, SCH SCR, (V08664) 024-2900-000	P,Q,X AB,AC,AD AE,AF,AG AM,AN,AP AQ,AR,AS AT,AU,AV AW,AX	1
38	606-9714-004	2	PLATE, MARKING	A,B,D,E F,G,H,J M,X AM,AN	1
38	606-9714-004	2	PLATE, MARKING (EFF TO CI 72204)	C	1
38	606-9714-007	2	PLATE, MARKING (EFF CI 72204)	C	1
38	606-9714-005	2	PLATE, MARKING	K,L,Q,Y Z	1

GROUP ASSEMBLY PARTS LIST

FIG - ITEM	PART NO	INDENT	DESCRIPTION	USABLE ON CODE	UNITS PER ASSY
1	38 606-9714-005	2	PLATE, MARKING (EFF TO CI 72176)	N	1
	38 606-9714-006	2	PLATE, MARKING (EFF CI 72176 TO CI 72374)	N	1
	38 606-0545-010	2	PLATE, MARKING, (EFF CI 72374)	N	1
	38 606-9714-008	2	PLATE, MARKING	P, AA, AC AD, AE, AF	1
	38 606-9714-014	2	PLATE, MARKING	AG	1
	38 609-0545-011	2	PLATE, MARKING	AP, AQ, AR	1
	38 609-0545-008	2	PLATE, MARKING	AS, AT, AU AV, AW	1
	38 609-0545-013	2	PLATE, MARKING	AB, AX	1
	P313-0132-000	2	NUT, PLAIN, HEX, SST, 4-40 (V77250) 313-0132-000 (AP)		3
	MS35338-135	2	WASHER, LOCK, SST, 0.115 ID X 0.209 OD (V96906)		3
	310-0045-000	2	WASHER, FLAT, SST, 0.125 ID X 0.312 OD (V79807) 310-0045-000 (AP)		3
	39 606-9432-001	2	PLATE, TIE		2
	MS51959-13	2	SCREW, MACH, SST, 4-40 X 1/4 (V96906) 342-0044-000 (AP)		18
	MS51959-14	2	SCREW, MACH, SST, 4-40 X 5/16 (V96906) 342-0045-000 (AP)		8
	LL51959-12	2	SCREW, SLFLKG, SST, 4-40 X 3/16 (V03038) 330-2485-000 (AP)		2
40 606-9423-003	2	CHASSIS ASSY, RECEIVER (SEE FIG 26)	A, B, C, D E, F, G, H J, M, P AA, AB, AM AN, AP	1	
40 606-9423-005	2	CHASSIS ASSY, RECEIVER (SEE FIG 26)	K, L, N, O Y, Z AG, AD	1	
40 606-9423-006	2	CHASSIS ASSY, RECEIVER (SEE FIG 26)	X AW	1	
40 606-9423-007	2	CHASSIS ASSY, RECEIVER (SEE FIG 26)	AC, AD, AE AF, AR, AS AT, AU, AV	1	
40 606-9423-009	2	CHASSIS ASSY, RECEIVER (SEE FIG 26)	AX	1	
41 609-0507-001	2	CABLE, POWER, 115V		1	
41 609-0506-001	2	CABLE, POWER, 230V (EFF TO CI 72413)	A, B, C, D	1	
			E, F, G, H J, K, L, M X, Y, Z AA, AC		
41 618-3339-001	2	CABLE, POWER, 230V (EFF CI 72413)	A, B, C, D E, F, G, H J, K, L, M X, Y, Z AA, AC	1	
41 618-3339-001	2	CABLE, POWER, 230V	P, Q, AB	1	
			AD, AE, AF AG, AM, AN AP, AQ, AR AS, AT, AU AV, AW, AX		
609-1565-001	1	MOD KIT, AUTO SCAN CONTROL (OPTIONAL)	A, C, D, G H, J, K, L N, Y, AA AC, AE, AG AM, AN, AP AR, AT, AU AV	1	
42 783-9368-001	2	CIRCUIT CARD ASSY, AUTO SCAN CONTROL A9 (OPTIONAL) (SEE FIG 41)	A, C, D, G H, J, K, L N, Y, AA AC, AE, AG AM, AN, AP AR, AT, AU AV	1	

GROUP ASSEMBLY PARTS LIST

FIG - ITEM	PART NO	INDENT	DESCRIPTION	USABLE ON CODE	UNITS PER ASSY
1	43	609-0944-001	2 PLATE, MARKING	A,C,D,G H,J,K,L N,Y,AA AC,AE,AG AM,AN,AP AR,AT,AU AV	1
	44	609-1554-001	2 ADAPTER CARD, INTERCONNECT	A,C,D,G H,J,K,L N,Y,AA AC,AE,AG AM,AN,AP AR,AT,AU AV	1
	45	792-6980-001	1 ADAPTER, RECEIVER 699J-1 (SEE FIG 42)		1
2 *	783-9283-001		1 CIRCUIT CARD ASSY, FREQUENCY CONTROL A14 (SEE FIG 1-10 FOR NHA)		RF
	1	U4L9327592	2 INTEGRATED CKT, (V07263) 351-7569-020 A14U1		1
	2	MC946F	2 INTEGRATED CKT, (V04713) 351-7399-030 A14U9		1
	3	MC946F	2 INTEGRATED CKT, (V04713) 351-7399-030 A14U8		1
	4	SG143	2 INTEGRATED CKT, (V93332) 351-7094-020 A14U14		1
	5	SG143	2 INTEGRATED CKT, (V93332) 351-7094-020 A14U15		1
	6	U3M930659X	2 INTEGRATED CKT, (V07263) 351-7475-020 A14U21		1
	7	CK05BX103M	2 CAPACITOR,FXD, CER DIEL, 0.01UF, 20%, 100V (V81349) 913-5019-660 A14C3		1
	8	U3M930659X	2 INTEGRATED CKT, (V07263) 351-7475-020 A14U22		1
	9	SG143	2 INTEGRATED CKT, (V93332) 351-7094-020 A14U16		1
	10	U3M930659X	2 INTEGRATED CKT, (V07263) 351-7475-020 A14U23		1
	11	RCR05G102K	2 RESISTOR,FXD, CMPSN, 1K, 10%, 1/8W (V81349) 745-2341-000 A14R3		1
	12	SG143	2 INTEGRATED CKT, (V93332) 351-7094-020 A14U17		1
	13	U3M930659X	2 INTEGRATED CKT, (V07263) 351-7475-020 A14U24		1
	14	M39003-01-2044	2 CAPACITOR,FXD, ELCTLT, 2.2UF, 20%, 20V (V81349) 184-9083-440 A14C17		1
	15	SG143	2 INTEGRATED CKT, (V93332) 351-7094-020 A14U18		1
	16	U3M930659X	2 INTEGRATED CKT, (V07263) 351-7475-020 A14U25		1
	17	CK05BX103M	2 CAPACITOR,FXD, CER DIEL, 0.01UF, 20%, 100V (V81349) 913-5019-660 A14C29		1
	18	RCR05G223K	2 RESISTOR,FXD, CMPSN, 22K, 10%, 1/8W (V81349) 745-2389-000 A14R2		1
	19	RCR05G102K	2 RESISTOR,FXD, CMPSN, 1K, 10%, 1/8W (V81349) 745-2341-000 A14R1		1
	20	CK05BX103M	2 CAPACITOR,FXD, CER DIEL, 0.01UF, 20%, 100V (V81349) 913-5019-660 A14C31		1
	21	SG143	2 INTEGRATED CKT, (V93332) 351-7094-020 A14U33		1
	22	SG193	2 INTEGRATED CKT, (V93332) 351-7102-020 A14U26		1
	23	SG383	2 INTEGRATED CKT, (V93332) 351-7453-020 A14U19		1
	24	SF53	2 INTEGRATED CKT, (V93332) 351-7108-020 A14U34		1
	25	150D106X9020B2	2 CAPACITOR,FXD, ELCTLT, 10UF, 10%, 20V (V56289) 184-7720-000 A14C24		1
	26	SF53	2 INTEGRATED CKT, (V93332) 351-7108-020 A14U27		1
	27	SG193	2 INTEGRATED CKT, (V93332) 351-7102-020 A14U20		1
	28	CK05BX103M	2 CAPACITOR,FXD, CER DIEL, 0.01UF, 20%, 100V (V81349) 913-5019-660 A14C33		1



GROUP ASSEMBLY PARTS LIST

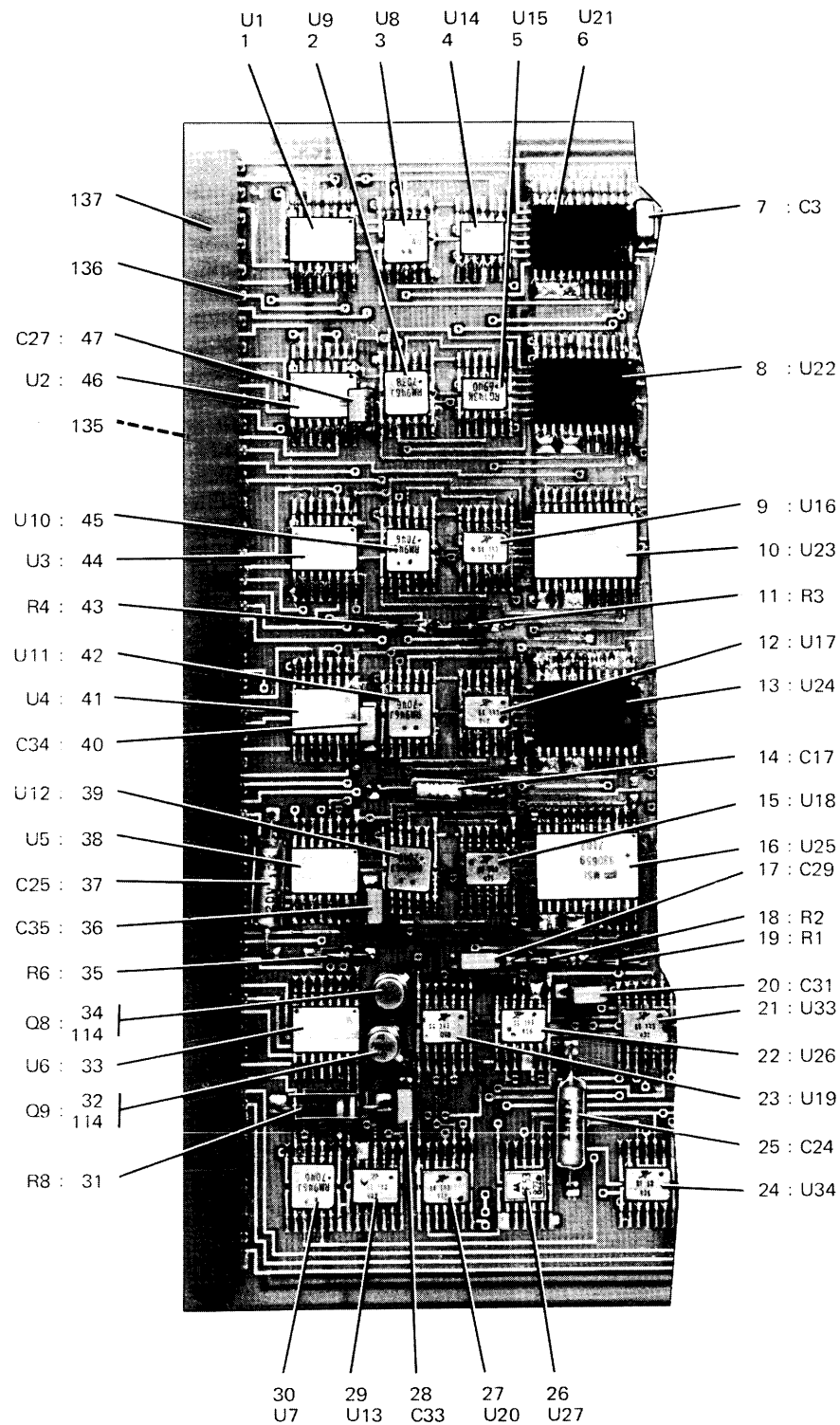

TP3-1057-027

Frequency Control Circuit Card Assembly (A14) 783-9283-001  
Figure 2 (Sheet 1 of 2)

GROUP ASSEMBLY PARTS LIST

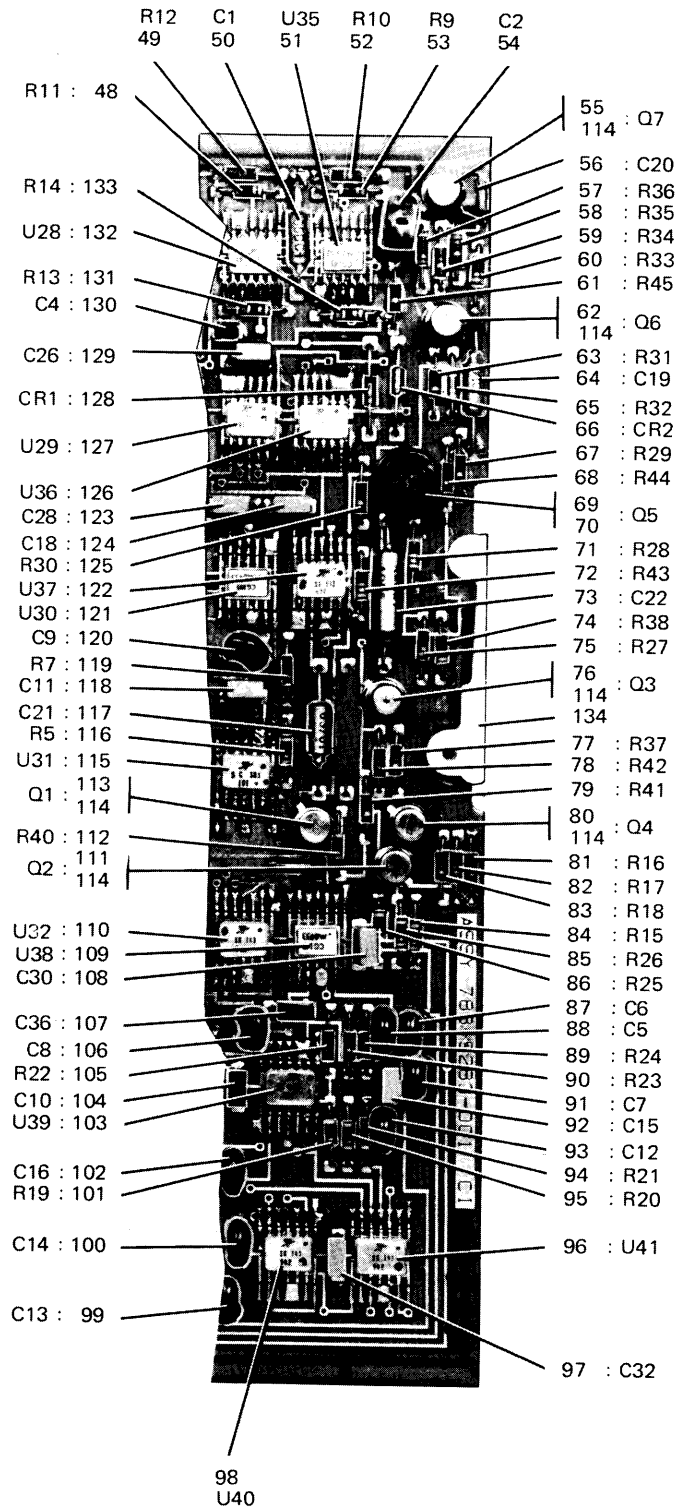

TP3-1057-027

Frequency Control Circuit Card Assembly (A14) 783-9283-001  
Figure 2 (Sheet 2 of 2)

## GROUP ASSEMBLY PARTS LIST

FIG - ITEM	PART NO	INDENT	DESCRIPTION	USABLE ON CODE	UNITS PER ASSY
2	29	SG143	2 INTEGRATED CKT. (V93332) 351-7094-020 A14U13		1
	30	MC946F	2 INTEGRATED CKT. (V04713) 351-7399-030 A14U7		1
	31	RCR20G220KS	2 RESISTOR,FXD, CMPSN, 22 OHMS, 10%, 1/2W (V81349) 745-1282-000 A14R8		1
	32	2N2222	2 TRANSISTOR, (V07688) 352-0552-000 A14Q9		1
	33	J4L9327592	2 INTEGRATED CKT. (V07263) 351-7569-020 A14U6		1
	34	2N2369A	2 TRANSISTOR, (V81350) 352-7500-450 A14Q8		1
	35	RCR05G222K	2 RESISTOR,FXD, CMPSN, 2.2K, 10%, 1/8W (V81349) 745-2353-000 A14R6		1
	36	CK058X103M	2 CAPACITOR,FXD, CER DIEL, 0.01UF, 20%, 100V (V81349) 913-5019-660 A14C35		1
	37	150D106X9020B2	2 CAPACITOR,FXD, ELCTLT, 10UF, 10%, 20V (V56289) 184-7720-000 A14C25		1
	38	J4L9327592	2 INTEGRATED CKT. (V07263) 351-7569-020 A14U5		1
	39	MC946F	2 INTEGRATED CKT. (V04713) 351-7399-030 A14U12		1
	40	CK058X103M	2 CAPACITOR,FXD, CER DIEL, 0.01UF, 20%, 100V (V81349) 913-5019-660 A14C34		1
	41	J4L9327592	2 INTEGRATED CKT. (V07263) 351-7569-020 A14U4		1
	42	MC946F	2 INTEGRATED CKT. (V04713) 351-7399-030 A14U11		1
	43	RCR05G223K	2 RESISTOR,FXD, CMPSN, 22K, 10%, 1/8W (V81349) 745-2389-000 A14R4		1
	44	J4L9327592	2 INTEGRATED CKT. (V07263) 351-7569-020 A14U3		1
	45	MC946F	2 INTEGRATED CKT. (V04713) 351-7399-030 A14U10		1
	46	J4L9327592	2 INTEGRATED CKT. (V07263) 351-7569-020 A14U2		1
	47	CK058X103M	2 CAPACITOR,FXD, CER DIEL, 0.01UF, 20%, 100V (V81349) 913-5019-660 A14C27		1
	48	RCR05G472K	2 RESISTOR,FXD, CMPSN, 4.7K, 10%, 1/8W (V81349) 745-2365-000 A14R11		1
	49	RCR05G223K	2 RESISTOR,FXD, CMPSN, 22K, 10%, 1/8W (V81349) 745-2389-000 A14R12		1
	50	150D105X9035A2	2 CAPACITOR,FXD, ELCTLT, 1UF, 10%, 35V (V56289) 184-7697-000 A14C1		1
	51	SG143	2 INTEGRATED CKT. (V93332) 351-7094-020 A14U35		1
	52	RCR05G223K	2 RESISTOR,FXD, CMPSN, 22K, 10%, 1/8W (V81349) 745-2389-000 A14R10		1
	53	RCR05G472K	2 RESISTOR,FXD, CMPSN, 4.7K, 10%, 1/8W (V81349) 745-2365-000 A14R9		1
	54	K1P35	2 CAPACITOR,FXD, ELCTLT, 1UF, 20%, 35V (V05397) 184-9525-000 A14C2		1
	55	2N2369A	2 TRANSISTOR, (V81350) 352-7500-450 A14Q7		1
	56	CK058X102M	2 CAPACITOR,FXD, CER DIEL, 1000PF, 20%, 200V (V81349) 913-3989-000 A14C20		1
	57	RCR05G681K	2 RESISTOR,FXD, CMPSN, 680 OHMS, 10%, 1/8W (V81349) 745-2335-000 A14R36		1
	58	RCR05G332K	2 RESISTOR,FXD, CMPSN, 3.3K, 10%, 1/8W (V81349) 745-2359-000 A14R35		1
	59	RCR05G821K	2 RESISTOR,FXD, CMPSN, 820 OHMS, 10%, 1/8W (V81349) 745-2338-000 A14R34		1
	60	RCR05G472K	2 RESISTOR,FXD, CMPSN, 4.7K, 10%, 1/8W (V81349) 745-2365-000 A14R33		1
	61	RCR05G101K	2 RESISTOR,FXD, CMPSN, 100 OHMS, 10%, 1/8W (V81349) 745-2304-000 A14R45		1
	62	2N2222	2 TRANSISTOR, (V07688) 352-0552-000 A14Q6		1
	63	RCR05G102K	2 RESISTOR,FXD, CMPSN, 1K, 10%, 1/8W (V81349) 745-2341-000 A14R31		1
	64	M39003-01-2014	2 CAPACITOR,FXD, ELCTLT, 4.7UF, 10%, 10V (V81349) 184-9083-140 A14C19		1
	65	RCR05G472K	2 RESISTOR,FXD, CMPSN, 4.7K, 10%, 1/8W (V81349) 745-2365-000 A14R32		1
	66	1N914	2 SEMICOND DEVICE, (V07688) 353-2906-000 A14CR2		1
	67	RCR05G270K	2 RESISTOR,FXD, CMPSN, 27 OHMS, 10%, 1/8W (V81349) 745-2283-000 A14R29		1

GROUP ASSEMBLY PARTS LIST

FIG - ITEM	PART NO	INDENT	DESCRIPTION	USABLE ON CODE	UNITS PER ASSY
2 68	RCR05G270K	2	RESISTOR,FXD, CMPSN, 27 OHMS, 10%, 1/8W (V81349) 745-2283-000 A14R44		1
69	2N1671	2	TRANSISTOR, (V07688) 352-0351-000 A14Q5		1
70	7717-114N	2	INSULATOR,DISK, (V13103) 352-9552-550		1
71	RCR05G104K	2	RESISTOR,FXD, CMPSN, 100K, 10%, 1/8W (V81349) 745-2413-000 A14R28		1
72	RCR05G123K	2	RESISTOR,FXD, CMPSN, 12K, 10%, 1/8W (V81349) 745-2380-000 A14R43		1
73	150D106X902082	2	CAPACITOR,FXD, ELCTLT, 10UF, 10%, 20V (V56289) 184-7720-000 A14C22		1
74	RCR05G103K	2	RESISTOR,FXD, CMPSN, 10K, 10%, 1/8W (V81349) 745-2377-000 A14R38		1
75	RCR05G103K	2	RESISTOR,FXD, CMPSN, 10K, 10%, 1/8W (V81349) 745-2377-000 A14R27		1
76	2N2907	2	TRANSISTOR, (V07688) 352-0551-000 A14Q3		1
77	RCR05G273K	2	RESISTOR,FXD, CMPSN, 27K, 10%, 1/8W (V81349) 745-2392-000 A14R37		1
78	RCR05G223K	2	RESISTOR,FXD, CMPSN, 22K, 10%, 1/8W (V81349) 745-2389-000 A14R42		1
79	RCR05G102K	2	RESISTOR,FXD, CMPSN, 1K, 10%, 1/8W (V81349) 745-2341-000 A14R41		1
80	2N2222	2	TRANSISTOR, (V07688) 352-0552-000 A14Q4		1
81	RCR05G223K	2	RESISTOR,FXD, CMPSN, 22K, 10%, 1/8W (V81349) 745-2389-000 A14R16		1
82	RCR05G223K	2	RESISTOR,FXD, CMPSN, 22K, 10%, 1/8W (V81349) 745-2389-000 A14R17		1
83	RCR05G223K	2	RESISTOR,FXD, CMPSN, 22K, 10%, 1/8W (V81349) 745-2389-000 A14R18		1
84	RCR05G472K	2	RESISTOR,FXD, CMPSN, 4.7K, 10%, 1/8W (V81349) 745-2365-000 A14R15		1
85	RCR05G472K	2	RESISTOR,FXD, CMPSN, 4.7K, 10%, 1/8W (V81349) 745-2365-000 A14R26		1
86	RCR05G472K	2	RESISTOR,FXD, CMPSN, 4.7K, 10%, 1/8W (V81349) 745-2365-000 A14R25		1
87	DM5F391J050WV	2	CAPACITOR,FXD, MICA DIEI, 390PF, 5%, 50V (V72136) 912-4141-510 A14C6		1
88	DM5F391J050WV	2	CAPACITOR,FXD, MICA DIEI, 390PF, 5%, 50V (V72136) 912-4141-510 A14C5		1
89	RCR05G223K	2	RESISTOR,FXD, CMPSN, 22K, 10%, 1/8W (V81349) 745-2389-000 A14R24		1
90	RCR05G223K	2	RESISTOR,FXD, CMPSN, 22K, 10%, 1/8W (V81349) 745-2389-000 A14R23		1
91	DM5F391J050WV	2	CAPACITOR,FXD, MICA DIEI, 390PF, 5%, 50V (V72136) 912-4141-510 A14C7		1
92	CK058X103M	2	CAPACITOR,FXD, CER DIEI, 0.01UF, 20%, 100V (V81349) 913-5019-660 A14C15		1
93	DM5F391J050WV	2	CAPACITOR,FXD, MICA DIEI, 390PF, 5%, 50V (V72136) 912-4141-510 A14C12		1
94	RCR05G472K	2	RESISTOR,FXD, CMPSN, 4.7K, 10%, 1/8W (V81349) 745-2365-000 A14R21		1
95	RCR05G472K	2	RESISTOR,FXD, CMPSN, 4.7K, 10%, 1/8W (V81349) 745-2365-000 A14R20		1
96	SG143	2	INTEGRATED CKT, (V93332) 351-7094-020 A14U41		1
97	CK058X103M	2	CAPACITOR,FXD, CER DIEI, 0.01UF, 20%, 100V (V81349) 913-5019-660 A14C32		1
98	SG143	2	INTEGRATED CKT, (V93332) 351-7094-020 A14U40		1
99	DM5F391J050WV	2	CAPACITOR,FXD, MICA DIEI, 390PF, 5%, 50V (V72136) 912-4141-510 A14C13		1
100	DM5F391J050WV	2	CAPACITOR,FXD, MICA DIEI, 390PF, 5%, 50V (V72136) 912-4141-510 A14C14		1
101	RCR05G472K	2	RESISTOR,FXD, CMPSN, 4.7K, 10%, 1/8W (V81349) 745-2365-000 A14R19		1

## GROUP ASSEMBLY PARTS LIST

FIG - ITEM	PART NO	INDENT	DESCRIPTION	USABLE ON CODE	UNITS PER ASSY
2	102	DM5F221J050WV	2 CAPACITOR,FXD, MICA DIEL, 220PF, 5%, 50V (V72136) 912-4141-450 A14C16		1
	103	SG383	2 INTEGRATED CKT, (V93332) 351-7453-020 A14U39		1
	104	CK05BX104M	2 CAPACITOR,FXD, CER DIEL, 0.1UF, 20%, 50V (V81349) 913-5019-720 A14C10		1
	105	RCR05G223K	2 RESISTOR,FXD, CMPSN, 22K, 10%, 1/8W (V81349) 745-2389-000 A14R22		1
	106	DM5F221J050WV	2 CAPACITOR,FXD, MICA DIEL, 220PF, 5%, 50V (V72136) 912-4141-450 A14C8		1
	107	CK05BX102K	2 CAPACITOR,FXD, CER DIEL, 1000PF, 10%, 200V (V81349) 913-4018-000 A14C36		1
	108	CK05BX103M	2 CAPACITOR,FXD, CER DIEL, 0.01UF, 20%, 100V (V81349) 913-5019-660 A14C30		1
	109	SG143	2 INTEGRATED CKT, (V93332) 351-7094-020 A14U32		1
	110	SG143	2 INTEGRATED CKT, (V93332) 351-7094-020 A14U38		1
	111	2N2222	2 TRANSISTOR, (V07688) 352-0552-000 A1402		1
	112	RCR05G472K	2 RESISTOR,FXD, CMPSN, 4.7K, 10%, 1/8W (V81349) 745-2365-000 A14R40		1
	113	2N2369A	2 TRANSISTOR, (V81350) 352-7500-450 A1401		1
	114	7717-130DAP	2 INSULATOR,DISK, (V13103) 352-9552-580		8
	115	SG383	2 INTEGRATED CKT, (V93332) 351-7453-020 A14U31		1
	116	RCR05G472K	2 RESISTOR,FXD, CMPSN, 4.7K, 10%, 1/8W (V81349) 745-2365-000 A14R5		1
	117	M39003-01-2014	2 CAPACITOR,FXD, ELCTLT, 4.7UF, 10%, 10V (V81349) 184-9083-140 A14C21		1
	118	CK05BX103M	2 CAPACITOR,FXD, CER DIEL, 0.01UF, 20%, 100V (V81349) 913-5019-660 A14C11		1
	119	RCR05G223K	2 RESISTOR,FXD, CMPSN, 22K, 10%, 1/8W (V81349) 745-2389-000 A14R7		1
	120	DM5F221J050WV	2 CAPACITOR,FXD, MICA DIEL, 220PF, 5%, 50V (V72136) 912-4141-450 A14C9		1
	121	SG193	2 INTEGRATED CKT, (V93332) 351-7102-020 A14U30		1
	122	SG143	2 INTEGRATED CKT, (V93332) 351-7094-020 A14U37		1
	123	CK05BX103M	2 CAPACITOR,FXD, CER DIEL, 0.01UF, 20%, 100V (V81349) 913-5019-660 A14C28		1
	124	CK05BX103M	2 CAPACITOR,FXD, CER DIEL, 0.01UF, 20%, 100V (V81349) 913-5019-660 A14C18		1
	125	RCR05G271K	2 RESISTOR,FXD, CMPSN, 270 OHMS, 10%, 1/8W (V81349) 745-2320-000 A14R30		1
	126	SG43	2 INTEGRATED CKT, (V93332) 351-7078-020 A14U36		1
	127	SG193	2 INTEGRATED CKT, (V93332) 351-7102-020 A14U29		1
	128	1N914	2 SEMICOND DEVICE, (V07688) 353-2906-000 A14CR1		1
	129	CK05BX103M	2 CAPACITOR,FXD, CER DIEL, 0.01UF, 20%, 100V (V81349) 913-5019-660 A14C26		1
	130	G5448X102M	2 CAPACITOR,FXD, CER DIEL, 1000PF, 20%, 50V (V96733) 913-3244-250 A14C4		1
	131	RCR05G391K	2 RESISTOR,FXD, CMPSN, 390 OHMS, 10%, 1/8W (V81349) 745-2326-000 A14R13		1
	132	SG383	2 INTEGRATED CKT, (V93332) 351-7453-020 A14U28		1
	133	RCR05G391K	2 RESISTOR,FXD, CMPSN, 390 OHMS, 10%, 1/8W (V81349) 745-2326-000 A14R14		1
	134	783-9372-001	2 HANDLE		1
		MS16562-199	2 PIN,SPR, SST, 0.078 DIA X 1/4 (V96906) 311-0355-000 (AP)		1
	135	372-2234-010	2 CONTACT,ELEC, (V13499) 372-2234-010		43
	136	372-2234-020	2 CONTACT,ELEC, (V13499) 372-2234-020		42
	137	372-2623-052	2 HOUSING,CONN,EL, 372-2623-052		1

GROUP ASSEMBLY PARTS LIST

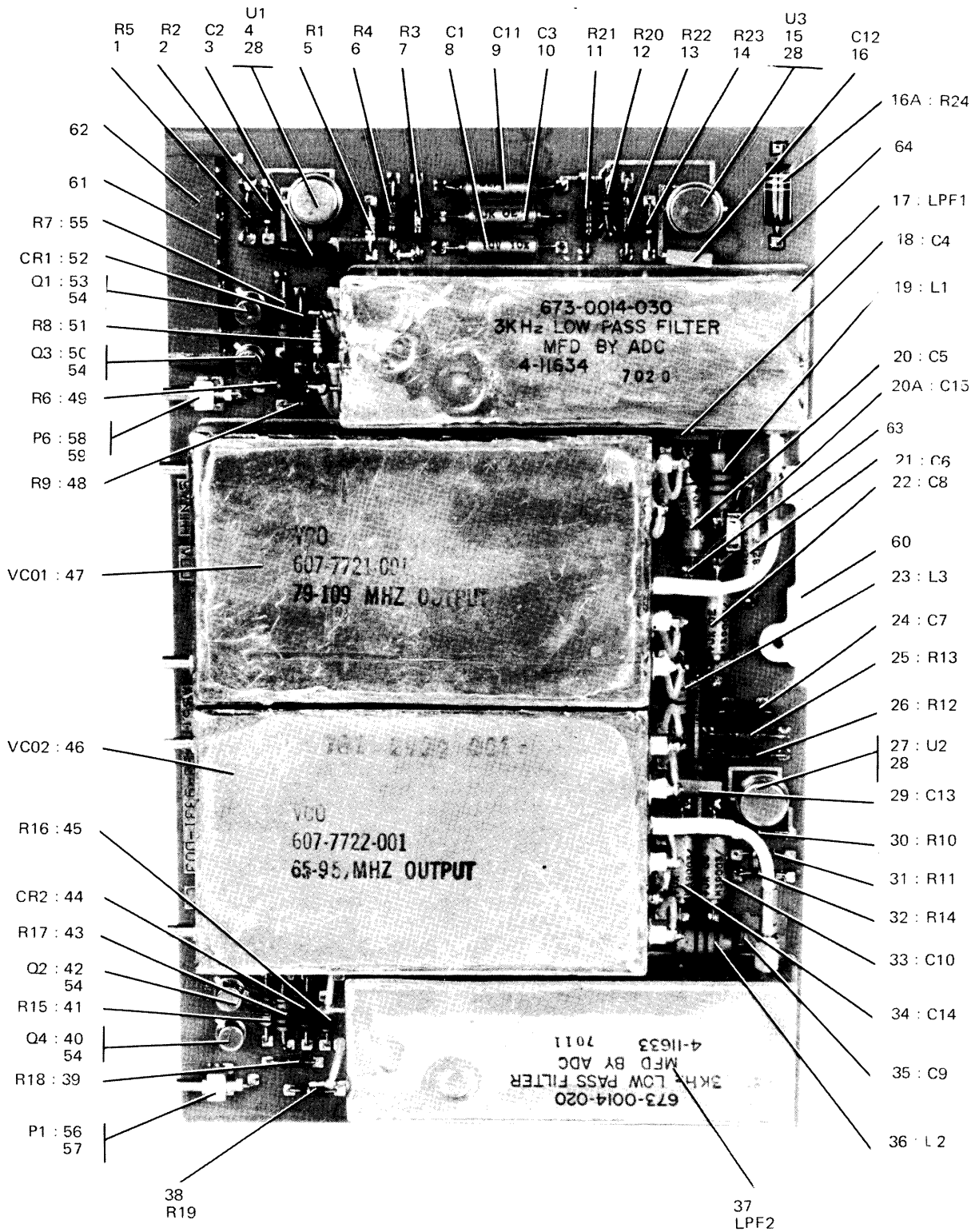

TP3-1056-017

Synthesizer VCO Circuit Card Assembly (A13) 793-9331-003  
Figure 3

## GROUP ASSEMBLY PARTS LIST

FIG - ITEM	PART NO	INDENT	DESCRIPTION	USABLE ON CODE	UNITS PER ASSY
3 -	793-9331-003	1	CIRCUIT CARD ASSY, SYNTHESIZER VCO A13 (SEE FIG 1-11 FOR NHA)		RF
	785-2881-001	2	RESISTOR KIT, TEST SELECT (EFF TO CI 72186) (NON-PROCURABLE ITEM)		1
1	RCR053103K	3	RESISTOR, FXD, CMPSN, 10K, 10%, 1/8W (V81349) 745-2377-000 A13R5		AR
1	RCR053123K	3	RESISTOR, FXD, CMPSN, 12K, 10%, 1/8W (V81349) 745-2380-000 A13R5		AR
1	RCR053153K	3	RESISTOR, FXD, CMPSN, 15K, 10%, 1/8W (V81349) 745-2383-000 A13R5		AR
1	RCR053183K	3	RESISTOR, FXD, CMPSN, 18K, 10%, 1/8W (V81349) 745-2386-000 A13R5		AR
1	RCR053223K	3	RESISTOR, FXD, CMPSN, 22K, 10%, 1/8W (V81349) 745-2389-000 A13R5		AR
1	RCR053273K	3	RESISTOR, FXD, CMPSN, 27K, 10%, 1/8W (V81349) 745-2392-000 A13R5		AR
1	RCR053333K	3	RESISTOR, FXD, CMPSN, 33K, 10%, 1/8W (V81349) 745-2395-000 A13R5		AR
1	RCR053393K	3	RESISTOR, FXD, CMPSN, 39K, 10%, 1/8W (V81349) 745-2398-000 A13R5		AR
1	RCR053333K	2	RESISTOR, FXD, CMPSN, 33K, 10%, 1/8W (V81349) 745-2395-000 A13R5 (EFF CI 72186)		1
2	RCR053100K	2	RESISTOR, FXD, CMPSN, 10 OHMS, 10%, 1/8W (V81349) 745-2268-000 A13R2		1
3	CM05F0101J03	2	CAPACITOR, FXD, MICA DIELECT, 100PF, 5%, 500V (V81349) 912-2816-000 A13C2		1
4	J5R7723312	2	INTEGRATED CKT, (V07263) 351-1035-010 A13U1		1
5	RCR05G222K	2	RESISTOR, FXD, CMPSN, 2.2K, 10%, 1/8W (V81349) 745-2353-000 A13R1		1
6	RN55D6491F	2	RESISTOR, FXD, FILM, 6.49K, 1%, 1/8W (V81349) 705-1035-000 A13R4		1
7	RN55D3481F	2	RESISTOR, FXD, FILM, 3.48K, 1%, 1/8W (V81349) 705-1022-000 A13R3 (EFF TO CI 73253)		1
7	RN55D6491F	2	RESISTOR, FXD, FILM, 6.49K, 1%, 1/8W (V81349) 705-1035-000 A13R3 (EFF CI 73253)		1
8	M39003-03-0024	2	CAPACITOR, FXD, ELECT, 82UF, 10%, 10V (V81349) 184-6329-220 A13C1		1
9	M39003-03-0024	2	CAPACITOR, FXD, ELECT, 82UF, 10%, 10V (V81349) 184-6329-220 A13C11		1
10	M39003-01-2050	2	CAPACITOR, FXD, ELECT, 15UF, 20%, 20V (V81349) 184-9083-500 A13C3 (EFF TO CI 72246)		1
10	M39003-03-0059	2	CAPACITOR, FXD, ELECT, 100UF, 20%, 20V (V81349) 184-6329-510 A13C3 (EFF CI 72246)		1
11	RN55D6811F	2	RESISTOR, FXD, FILM, 6.81K, 1%, 1/8W (V81349) 705-1036-000 A13R21		1
	785-2881-001	2	RESISTOR KIT, TEST SELECT (EFF TO CI 72186) (NON-PROCURABLE ITEM)		1
12	RCR053103K	3	RESISTOR, FXD, CMPSN, 10K, 10%, 1/8W (V81349) 745-2377-000 A13R20		AR
12	RCR053123K	3	RESISTOR, FXD, CMPSN, 12K, 10%, 1/8W (V81349) 745-2380-000 A13R20		AR
12	RCR053153K	3	RESISTOR, FXD, CMPSN, 15K, 10%, 1/8W (V81349) 745-2383-000 A13R20		AR
12	RCR053183K	3	RESISTOR, FXD, CMPSN, 18K, 10%, 1/8W (V81349) 745-2386-000 A13R20		AR
12	RCR053223K	3	RESISTOR, FXD, CMPSN, 22K, 10%, 1/8W (V81349) 745-2389-000 A13R20		AR
12	RCR053273K	3	RESISTOR, FXD, CMPSN, 27K, 10%, 1/8W (V81349) 745-2392-000 A13R20		AR
12	RCR053333K	3	RESISTOR, FXD, CMPSN, 33K, 10%, 1/8W (V81349) 745-2395-000 A13R20		AR
12	RCR053393K	3	RESISTOR, FXD, CMPSN, 39K, 10%, 1/8W (V81349) 745-2398-000 A13R20		AR
12	RCR05G273K	2	RESISTOR, FXD, CMPSN, 27K, 10%, 1/8W (V81349) 745-2392-000 A13R20 (EFF CI 72186)		1

GROUP ASSEMBLY PARTS LIST

FIG - ITEM	PART NO	INDENT	DESCRIPTION	USABLE ON CODE	UNITS PER ASSY
3 13	RN55D2431F	2	RESISTOR,FXD, FILM, 2.43K, 1%, 1/8W (V81349) 705-3605-180 A13R22		1
14	RCR05G150K	2	RESISTOR,FXD, CMPSN, 15 OHMS, 10%, 1/8W (V81349) 745-2274-000 A13R23		1
15	LM104H	2	INTEGRATED CKT, (V27014) 351-1062-020 A13U3		1
16	CK068X104K	2	CAPACITOR,FXD, CER DIEL, 0.1UF, 10%, 100V (V81349) 913-5019-440 A13C12		1
16A	RCR07G331KS	2	RESISTOR, FXD, CMPSN, 330 OHMS, 10%, 1/4W (V81349) 745-0731-000 A13R24 (EFF CI 73236)		1
17	4-11634	2	FILTER,LP, (V70674) 673-0014-030 A13LPF1		1
	P330-3059-020	2	SCREW,MACH, STL, 2-56UNC2A X 3/16 (V77250) 330-3059-020 (AP)		4
18	CK068X104K	2	CAPACITOR,FXD, CER DIEL, 0.1UF, 10%, 100V (V81349) 913-5019-440 A13C4		1
19	M590537-41	2	COIL,RF, 220UH (V96906) 240-2715-410 A13L1		1
20	M39003-01-2050	2	CAPACITOR,FXD, ELCTLT, 15UF, 20%, 20V (V81349) 184-9083-500 A13C5 (EFF TO CI 72246)		1
20	M39003-03-0059	2	CAPACITOR,FXD, ELCTLT, 100UF, 20%, 20V (V81349) 184-6329-510 A13C5 (EFF CI 72246)		1
20A	M39003-03-0059	2	CAPACITOR, FXD, ELCTLT, 100UF, 20%, 20V (V81349) 184-6329-510 A13C15 (EFF CI 73236)		1
21	M39003-03-0024	2	CAPACITOR,FXD, ELCTLT, 82UF, 10%, 10V (V81349) 184-6329-220 A13C6		1
22	M39003-01-2050	2	CAPACITOR,FXD, ELCTLT, 15UF, 20%, 20V (V81349) 184-9083-500 A13C8		1
23	240-2711-300	2	COIL,RF, 270UH (V99800) 240-2711-300 A13L3		1
24	CM05FD101J03	2	CAPACITOR,FXD, MICA DIEL, 100PF, 5%, 500V (V81349) 912-2816-000 A13C7		1
25	RN55D6491F	2	RESISTOR,FXD, FILM, 6.49K, 1%, 1/8W (V81349) 705-1035-000 A13R13		1
26	RN55D3481F	2	RESISTOR,FXD, FILM, 3.48K, 1%, 1/8W (V81349) 705-1022-000 A13R12 (EFF TO CI 73253)		1
26	RN55D6491F	2	RESISTOR, FXD, FILM, 6.49K, 1%, 1/8W (V81349) 705-1035-000 A3R12 (EFF CI 73253)		1
27	J5R7723312	2	INTEGRATED CKT, (V07263) 351-1035-010 A13U2		1
28	352-9577-030	2	PAD,MTG,SEMICON, 352-9577-030		3
29	CK068X104K	2	CAPACITOR,FXD, CER DIEL, 0.1UF, 10%, 100V (V81349) 913-5019-440 A13C13		1
30	RCR05G222K	2	RESISTOR,FXD, CMPSN, 2.2K, 10%, 1/8W (V81349) 745-2353-000 A13R10		1
31	RCR05G100K	2	RESISTOR,FXD, CMPSN, 10 OHMS, 10%, 1/8W (V81349) 745-2268-000 A13R11		1
	745-2881-001	2	RESISTOR KIT, TEST SELECT (EFF TO CI 72186) (NON-PROCURABLE ITEM)		1
32	RCR05G103K	3	RESISTOR,FXD, CMPSN, 10K, 10%, 1/8W (V81349) 745-2377-000 A13R14		AR
32	RCR05G123K	3	RESISTOR,FXD, CMPSN, 12K, 10%, 1/8W (V81349) 745-2380-000 A13R14		AR
32	RCR05G153K	3	RESISTOR,FXD, CMPSN, 15K, 10%, 1/8W (V81349) 745-2383-000 A13R14		AR
32	RCR05G183K	3	RESISTOR,FXD, CMPSN, 18K, 10%, 1/8W (V81349) 745-2386-000 A13R14		AR
32	RCR05G223K	3	RESISTOR,FXD, CMPSN, 22K, 10%, 1/8W (V81349) 745-2389-000 A13R14		AR
32	RCR05G273K	3	RESISTOR,FXD, CMPSN, 27K, 10%, 1/8W (V81349) 745-2392-000 A13R14		AR
32	RCR05G333K	3	RESISTOR,FXD, CMPSN, 33K, 10%, 1/8W (V81349) 745-2395-000 A13R14		AR
32	RCR05G393K	3	RESISTOR,FXD, CMPSN, 39K, 10%, 1/8W (V81349) 745-2398-000 A13R14		AR
32	RCR05G333K	2	RESISTOR,FXD, CMPSN, 33K, 10%, 1/8W (V81349) 745-2395-000 A13R14 (EFF CI 72186)		1
33	M39003-01-2050	2	CAPACITOR,FXD, ELCTLT, 15UF, 20%, 20V (V81349) 184-9083-500 A13C10		1
34	CK068X104K	2	CAPACITOR,FXD, CER DIEL, 0.1UF, 10%, 100V (V81349) 913-5019-440 A13C9		1



## GROUP ASSEMBLY PARTS LIST

FIG - ITEM	PART NO	INDENT	DESCRIPTION	USABLE ON CODE	UNITS PER ASSY
3	35	M39003-01-2050	2 CAPACITOR, FXD, ELECT, 15UF, 20%, 20V (V81349) 1A4-9083-500 A13C14		1
	36	M590537-41	2 COIL, RF, 220UH (V96906) 240-2715-410 A1312		1
	37	4-11633	2 FILTER, LP, (V70674) 673-0014-020 A13LPF2		1
		P330-3059-020	2 SCREW, MACH, STL, 2-56UNC2A X 3/16 (V77250) 330-3059-020 (AP)		4
	38	RCR05G103K	2 RESISTOR, FXD, CMPSN, 10K, 10%, 1/8W (V81349) 745-2377-000 A13R19 (EFF TO CI 73126)		1
	38	C3103K	2 RESISTOR, FXD, FILM, 10K, 10%, 1/8W (V24546) 705-3153-370 A13R19 (EFF CI 73126)		1
	39	RCR05G682K	2 RESISTOR, FXD, FILM, 6.8K, 10%, 1/8W (V81349) 745-2371-000 A13R18 (EFF TO CI 73126)		1
	39	C3682K	2 RESISTOR, FXD, FILM, 6.8K, 10%, 1/8W (V24546) 705-3153-350 A13R18 (EFF CI 73136)		1
	40	352-7500-451	2 TRANSISTOR, 352-7500-451 A13Q4		1
	41	RCR07G222KS	2 RESISTOR, FXD, CMPSN, 2.2K, 10%, 1/4W (V81349) 745-0761-000 A13R15 (EFF TO CI 73126)		1
	41	T055-2210-1F	2 RESISTOR, FXD, FILM, 2.21K, 1%, 1/8W (V11502) 705-1468-100 A13R15 (EFF CI 73126)		1
	42	352-7500-451	2 TRANSISTOR, 352-7500-451 A13Q2		1
	43	RCR07G333KS	2 RESISTOR, FXD, CMPSN, 33K, 10%, 1/4W (V81349) 745-0803-000 A13R17 (EFF TO CI 73126)		1
	43	C3333K	2 RESISTOR, FXD, FILM, 33K, 10%, 1/8W (V24546) 705-3153-430 A13R17 (EFF CI 73126)		1
	44	353-3338-001	2 SEMICOND DEVICE, 353-3338-001 A13CR2		1
	45	RCR05G472K	2 RESISTOR, FXD, CMPSN, 4.7K, 10%, 1/8W (V81349) 745-2365-000 A13R16 (EFF TO CI 73126)		1
	45	C3472K	2 RESISTOR, FXD, FILM, 4.7K, 10%, 1/8W (V24546) 705-3153-330 A13R16 (EFF CI 73126)		1
	46	607-7722-001	2 LOOP ASSY, VCO, 64-96 MHZ A13VC02		1
		P330-3059-020	2 SCREW, MACH, STL, 2-56UNC2A X 3/16 (V77250) 330-3059-020 (AP)		4
	47	607-7721-001	2 LOOP ASSY, VCO, 79-109 MHZ A13VC01		1
		P330-3059-020	2 SCREW, MACH, STL, 2-56UNC2A X 3/16 (V77250) 330-3059-020 (AP)		4
	48	RCR05G103K	2 RESISTOR, FXD, CMPSN, 10K, 10%, 1/8W (V81349) 745-2377-000 A13R9 (EFF TO CI 73126)		1
	48	C3103K	2 RESISTOR, FXD, FILM, 10K, 10%, 1/8W (V24546) 705-3153-370 A13R9 (EFF CI 73126)		1
	49	RCR05G682K	2 RESISTOR, FXD, CMPSN, 6.8K, 10%, 1/8W (V81349) 745-2371-000 A13R6 (EFF TO CI 73126)		1
	49	C3682K	2 RESISTOR, FXD, FILM, 6.8K, 10%, 1/8W (V24546) 705-3153-350 A13R6 (EFF CI 73126)		1
	50	352-7500-451	2 TRANSISTOR, 352-7500-451 A13Q3		1
	51	RCR05G222K	2 RESISTOR, FXD, CMPSN, 2.2K, 10%, 1/8W (V81349) 745-2353-000 A13R8 (EFF TO CI 73126)		1
	51	T055-5490-1F	2 RESISTOR, FXD, FILM, 5.49K, 1%, 1/8W (V11502) 705-1468-290 A13R8 (EFF CI 73126)		1
	52	353-3338-001	2 SEMICOND DEVICE, 353-3338-001 A13CR1		1
	53	352-7500-451	2 TRANSISTOR, 352-7500-451 A13Q1		1
	54	352-9577-040	2 PAD, MTG, SEMICON, 352-9577-040		4
	55	RCR07G222KS	2 RESISTOR, FXD, CMPSN, 2.2K, 10%, 1/4W (V81349) 745-0761-000 A13R7 (EFF TO CI 73126)		1
	55	T055-2210-1F	2 RESISTOR, FXD, CMPSN, 2.21K, 1%, 1/8W (V11502) 705-1468-100 A13R7 (EFF CI 73126)		1
	56	141-1002-0003	2 CONNECTOR, RCPT, ELEC (V98278) 357-7353-020 A13P1		1
	57	793-9822-001	2 HOUSING, CONNECTOR		1
	58	141-1002-0003	2 CONNECTOR, RCPT, ELEC (V98278) 357-7353-020 A13P6		1
	59	793-9822-001	2 HOUSING, CONNECTOR		1
	60	783-9490-001	2 HANDLE		1
		MS51923-314	2 PIN, SPRING, SST, 0.078 DIA X 1/4 (V96906) 311-0465-000 (AP)		1
	61	372-2234-010	2 CONTACT, ELEC, (V13499) 372-2234-010		9
	62	372-2621-018	2 HOUSING, CONN, 372-2621-018		1
	63	372-2601-168	2 CONTACT, ELEC, 372-2601-168		1
	64	SL354-351WHT	2 TERMINAL, FEEDTH, (V12615) 306-2474-010		3

GROUP ASSEMBLY PARTS LIST

FIG - ITEM	PART NO	INDENT	DESCRIPTION	USABLE ON CODE	UNITS PER ASSY
4 -	774-7842-001	1	CIRCUIT CARD ASSY, DCU A9 (SEE FIG 1-15 FOR NHA) AS		RF
1	SN74H103N	2	INTEGRATED CKT, (V01295) 351-7745-020 A9014		1
2	RCR05G332K	2	RESISTOR, FXD, CMPSN, 3.3K, 10%, 1/8W (VR1349) 745-2359-000 A9R45		1
3	8121-050-651-104 Z	2	CAPACITOR, FXD, CER DIEL, 0.1UF, M20XP80X, 50V (V720R2) 913-3279-500 A9C15		1
4	SN74H103N	2	INTEGRATED CKT, (V01295) 351-7745-020 A9014		1
5	DM5F331J050WV	2	CAPACITOR, FXD, MICA DIEL, 330PF, 5%, 50V (V72136) 912-4141-400 A9C26		1
6	RCR05G332K	2	RESISTOR, FXD, CMPSN, 3.3K, 10%, 1/8W (VR1349) 745-2359-000 A9R24		1

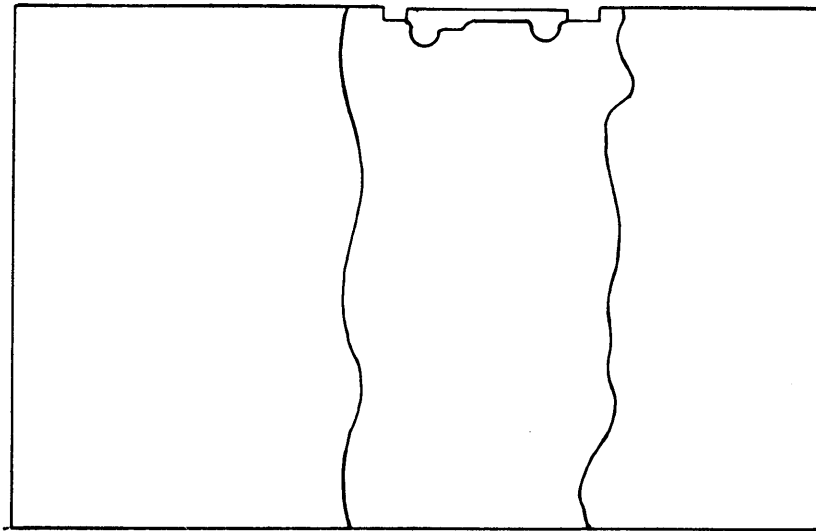

DETAIL A

DETAIL B

DETAIL C

TP3-3645-049

DCU Circuit Card Assembly (A9) 774-7842-001  
Figure 4 (Sheet 1 of 4)

GROUP ASSEMBLY PARTS LIST

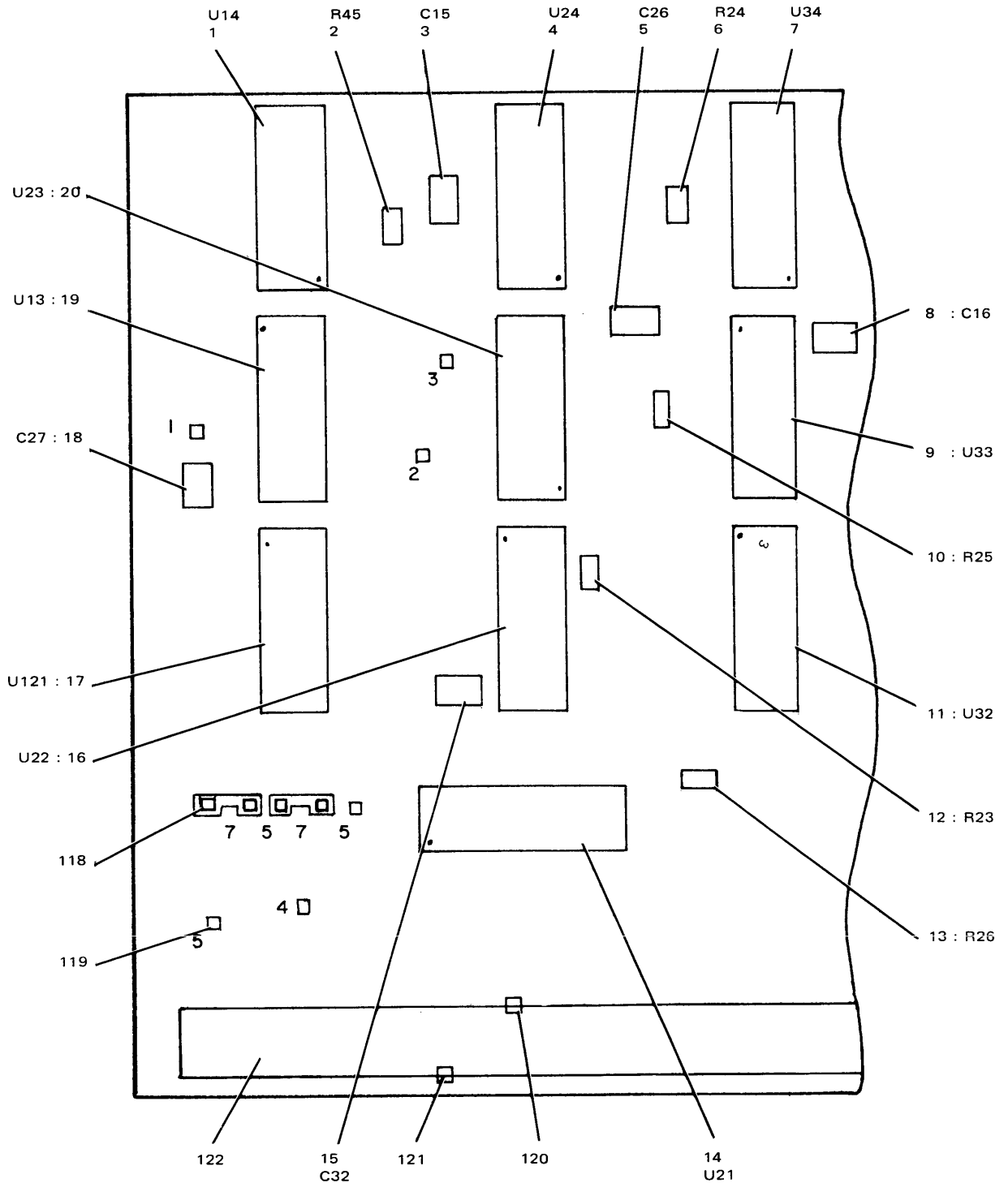

DETAIL A

TP3-3645-049

DCU Circuit Card Assembly (A9) 774-7842-001  
Figure 4 (Sheet 2 of 4)

GROUP ASSEMBLY PARTS LIST

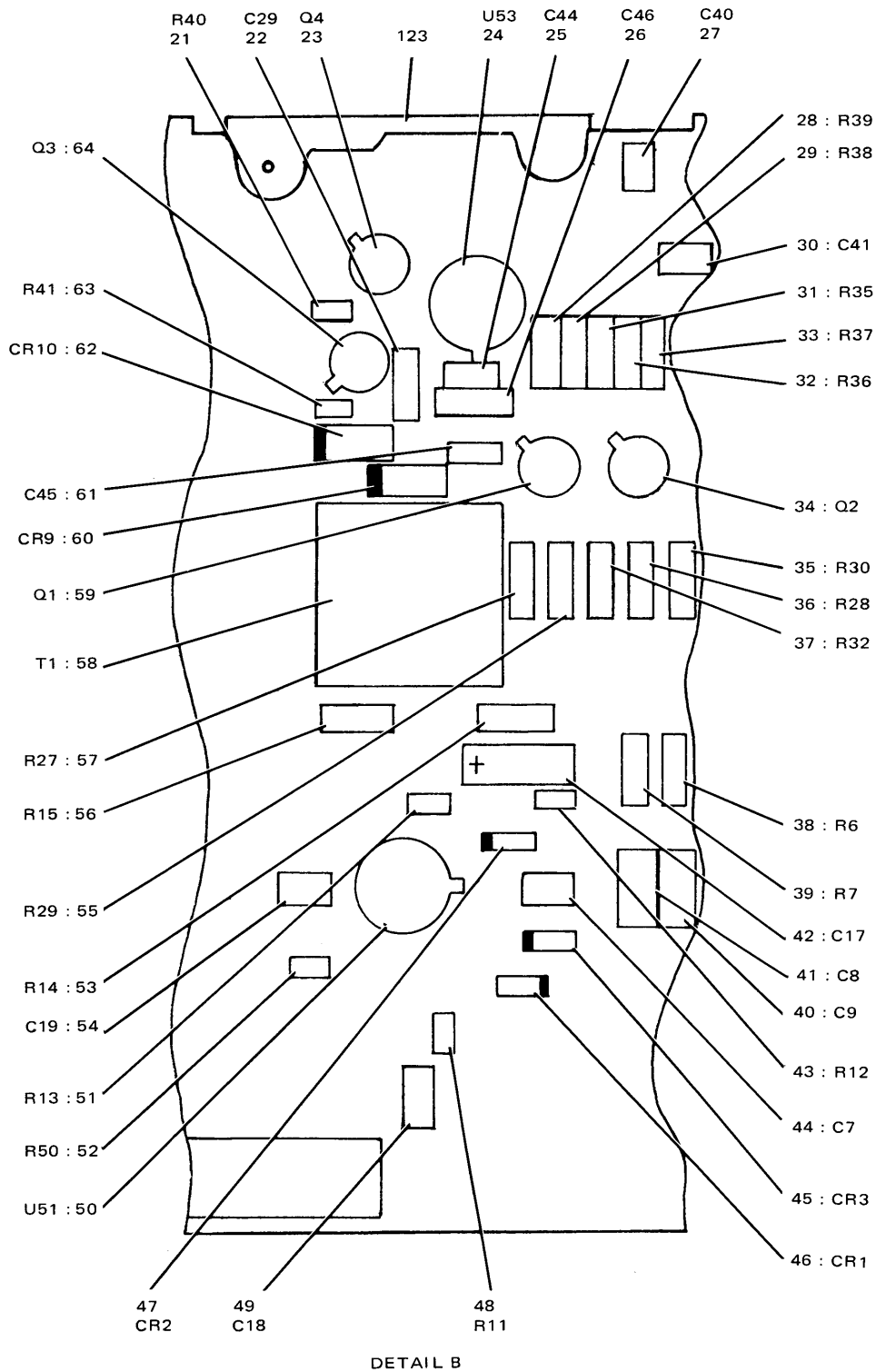

TP3-3645-049

DCU Circuit Card Assembly (A9) 774-7842-001  
Figure 4 (Sheet 3 of 4)

GROUP ASSEMBLY PARTS LIST

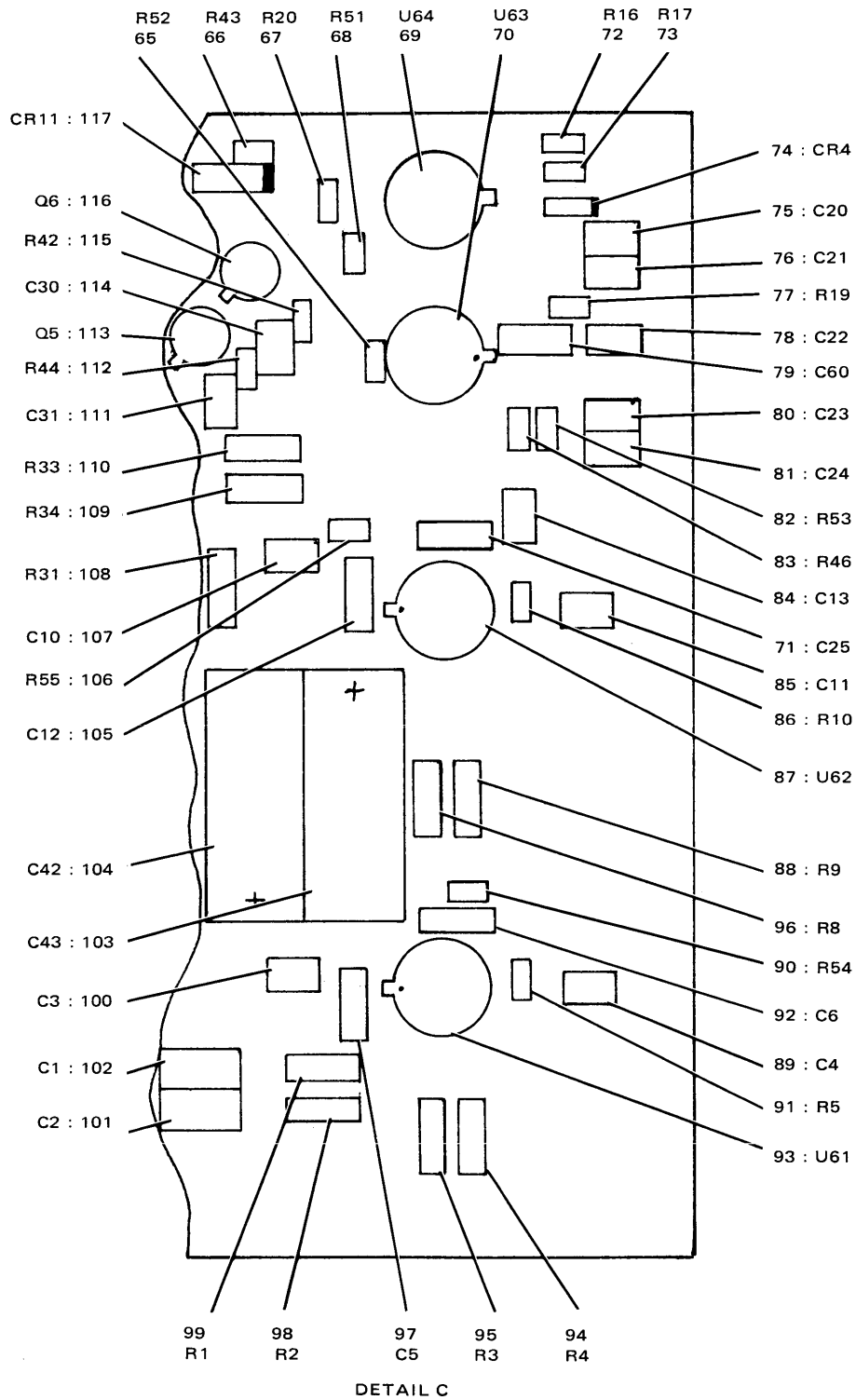

TP3-3645-049

DCU Circuit Card Assembly (A9) 774-7842-001  
Figure 4 (Sheet 4 of 4)

## GROUP ASSEMBLY PARTS LIST

FIG - ITEM	PART NO	INDENT	DESCRIPTION	USABLE ON CODE	UNITS PER ASSY
4	7		MC7404P		
	8	2	INTEGRATED CKT, (V04713) 351-7630-010 A9U34		1
	8	2	CAPACITOR,FXD, CER DIEL, 0.1UF, M20XP80%, 50V (V72982) 913-3279-500 A9C16		1
	9		MC7400P		
	10	2	INTEGRATED CKT, (V04713) 351-7629-010 A9U33		1
	10	2	RESISTOR,FXD, CMPSN, 150 OHMS, 10%, 1/8W (V81349) 745-2311-000 A9R25		1
	11		SN7474N		
	12	2	INTEGRATED CKT, (V01295) 351-7739-010 A9U32		1
	12	2	RESISTOR,FXD, CMPSN, 3.3K, 10%, 1/8W (V81349) 745-2359-000 A9R23		1
	13	2	RESISTOR,FXD, CMPSN, 3.3K, 10%, 1/8W (V81349) 745-2359-000 A9R26		1
	14		U68931259		
	15	2	INTEGRATED CKT, (V07263) 351-7430-040 A9U21		1
	15	2	CAPACITOR,FXD, CER DIEL, 0.1UF, M20XP80%, 50V (V72982) 913-3279-500 A9C32		1
	16		MC7401P		
	17	2	INTEGRATED CKT, (V04713) 351-7627-010 A9U22		1
	17	2	INTEGRATED CKT, (V04713) 351-7628-010 A9U12		1
	18	2	CAPACITOR,FXD, CER DIEL, 0.1UF, M20XP80%, 50V (V72982) 913-3279-500 A9C27		1
	19		SN74H74N		
	20	2	INTEGRATED CKT, (V01295) 351-7755-010 A9U13		1
	20	2	INTEGRATED CKT, (V01295) 351-7745-020 A9U23		1
	21	2	RESISTOR,FXD, CMPSN, 10K, 10%, 1/8W (V81349) 745-2377-000 A9R40		1
	22		DM5C030D050WV		
	22	2	CAPACITOR,FXD, MICA DIEL, 3PF, 0.5PF, 50V (V72136) 912-4141-070 A9C29		1
	23		2N2907A		
	24	2	TRANSISTOR, (V07688) 352-0551-010 A9Q4		1
	24	2	INTEGRATED CKT, (V07263) 351-1115-010 A9U53		1
	25	2	CAPACITOR,FXD, CER DIEL, 470PF, 10%, 200V (V81349) 913-4014-000 A9C44		1
	26	2	CAPACITOR,FXD, CER DIEL, 2200PF, 10%, 200V (V81349) 913-4022-000 A9C46		1
	27	2	CAPACITOR,FXD, CER DIEL, 0.01PF, M20XP80%, 50V (V13499) 913-3279-430 A9C40		1
	28	2	RESISTOR,FXD, FILM, 100 OHMS, 1%, 1/8W (V11502) 705-1454-150 A9R39		1
	29	2	RESISTOR,FXD, FILM, 15.4K, 1%, 1/8W (V11502) 705-1470-920 A9R38		1
	30	2	CAPACITOR,FXD, CER DIEL, 0.01PF, M20XP80%, 50V (V13499) 913-3279-430 A9C41		1
	31	2	RESISTOR,FXD, FILM, 5.11K, 1%, 1/8W (V11502) 705-1454-560 A9R35		1
	32	2	RESISTOR,FXD, FILM, 5.11K, 1%, 1/8W (V11502) 705-1454-560 A9R36		1
	33	2	RESISTOR,FXD, FILM, 5.11K, 1%, 1/8W (V11502) 705-1454-560 A9R37		1
	34		2N2432		
	34	2	TRANSISTOR, (V07688) 352-0441-000 A9Q2		1
	35	2	RESISTOR,FXD, FILM, 1.54K, 1%, 1/8W (V11502) 705-1470-670 A9R30		1
	36	2	RESISTOR,FXD, FILM, 7.5K, 1%, 1/8W (V11502) 705-1454-600 A9R28		1
	37	2	RESISTOR,FXD, FILM, 13.3K, 1%, 1/8W (V11502) 705-1454-660 A9R32		1
	38	2	RESISTOR,FXD, FILM, 26.1K, 1%, 1/8W (V11502) 705-1454-730 A9R6		1
	39	2	RESISTOR,FXD, FILM, 26.1K, 1%, 1/8W (V11502) 705-1454-730 A9R7		1
	40	2	CAPACITOR,FXD, CER DIEL, 0.1UF, 10%, 100V (V72982) 913-3118-190 A9C9		1
	41	2	CAPACITOR,FXD, CER DIEL, 0.1UF, 10%, 100V (V72982) 913-3118-190 A9C8		1
	42	2	CAPACITOR,FXD, ELCTLY, 0.15UF, 20%, 50V (V81349) 184-9084-290 A9C17		1

## GROUP ASSEMBLY PARTS LIST

FIG - ITEM	PART NO	INDENT	DESCRIPTION	USABLE ON CODE	UNITS PER ASSY
4	43	RCR05G152K	2 RESISTOR,FXD, CMPSN, 1.5K, 10%, 1/8W (V81349) 745-2347-000 A9R12		1
	44	8121-050-651-104 Z	2 CAPACITOR,FXD, CER DIEI, 0.1UF, M20XP80%, 50V (V72982) 913-3279-500 A9C7		1
	45	1N4454	2 SEMICOND DEVICE, (V03508) 353-3644-010 A9CR3		1
	46	1N4454	2 SEMICOND DEVICE, (V03508) 353-3644-010 A9CR1		1
	47	1N4454	2 SEMICOND DEVICE, (V03508) 353-3644-010 A9CR2		1
	48	RCR05G152K	2 RESISTOR,FXD, CMPSN, 1.5K, 10%, 1/8W (V81349) 745-2347-000 A9R11		1
	49	913-3279-430	2 CAPACITOR,FXD, CER DIEI, 0.01PF, M20XP80%, 50V (V13499) 913-3279-430 A9C18		1
	50	LM311H	2 INTEGRATED CKT, (V12040) 351-1094-060 A9U51		1
	51	RCR05G103K	2 RESISTOR,FXD, CMPSN, 10K, 10%, 1/8W (V81349) 745-2377-000 A9R13		1
	52	RCR05G332K	2 RESISTOR,FXD, CMPSN, 3.3K, 10%, 1/8W (V81349) 745-2359-000 A9R50		1
	53	T055-14-7K1F	2 RESISTOR,FXD, FILM, 14.7K, 1%, 1/8W (V11502) 705-1454-670 A9R14		1
	54	913-3279-430	2 CAPACITOR,FXD, CER DIEI, 0.01PF, M20XP80%, 50V (V13499) 913-3279-430 A9C19		1
	55	T055-1541-1F	2 RESISTOR,FXD, FILM, 1.54K, 1%, 1/8W (V11502) 705-1470-670 A9R29		1
	56	T055-10K1F	2 RESISTOR,FXD, FILM, 10K, 1%, 1/8W (V11502) 705-1454-630 A9R15		1
	57	T055-7-5K1F	2 RESISTOR,FXD, FILM, 7.5K, 1%, 1/8W (V11502) 705-1454-600 A9R27		1
	58	8-R79	2 TRANSFORMER,AF, (V27549) 677-0404-010 A9T1		1
	59	2N2432	2 TRANSISTOR, (V07688) 352-0441-000 A9Q1		1
	60	1N751	2 SEMICOND DEVICE, (V07688) 353-2709-000 A9CR9		1
	61	CK058X102K	2 CAPACITOR,FXD, CER DIEI, 1000PF, 10%, 200V (V81349) 913-4018-000 A9C45		1
	62	1N751	2 SEMICOND DEVICE, (V07688) 353-2709-000 A9CR10		1
	63	RCR05G560K	2 RESISTOR,FXD, CMPSN, 56 OHMS, 10%, 1/8W (V81349) 745-2295-000 A9R41		1
	64	2N2222A	2 TRANSISTOR, (V07688) 352-0661-020 A9Q3		1
	65	RCR05G332K	2 RESISTOR,FXD, CMPSN, 3.3K, 10%, 1/8W (V81349) 745-2359-000 A9R52		1
	66	RCR05G392K	2 RESISTOR,FXD, CMPSN, 3.9K, 10%, 1/8W (V81349) 745-2362-000 A9R43		1
	67	RCR05G223K	2 RESISTOR,FXD, CMPSN, 22K, 10%, 1/8W (V81349) 745-2389-000 A9R20		1
	68	RCR05G332K	2 RESISTOR,FXD, CMPSN, 3.3K, 10%, 1/8W (V81349) 745-2359-000 A9R51		1
	69	LM311H	2 INTEGRATED CKT, (V12040) 351-1094-060 A9U64		1
	70	LM311H	2 INTEGRATED CKT, (V12040) 351-1094-060 A9U63		1
	71	DM5C030D050WV	2 CAPACITOR,FXD, MICA DIEI, 3PF, 0.5PF, 50V (V72136) 912-4141-070 A9C25		1
	72	RCR05G102K	2 RESISTOR,FXD, CMPSN, 1K, 10%, 1/8W (V81349) 745-2341-000 A9R16		1
	73	RCR05G102K	2 RESISTOR,FXD, CMPSN, 1K, 10%, 1/8W (V81349) 745-2341-000 A9R17		1
	74	1N4454	2 SEMICOND DEVICE, (V03508) 353-3644-010 A9CR4		1
	75	913-3279-430	2 CAPACITOR,FXD, CER DIEI, 0.01PF, M20XP80%, 50V (V13499) 913-3279-430 A9C20		1
	76	913-3279-430	2 CAPACITOR,FXD, CER DIEI, 0.01PF, M20XP80%, 50V (V13499) 913-3279-430 A9C21		1
	77	RCR05G562K	2 RESISTOR,FXD, CMPSN, 5.6K, 10%, 1/8W (V81349) 745-2368-000 A9R19		1
	78	8121-100W5R103K	2 CAPACITOR,FXD, CER DIEI, 0.01UF, 10%, 100V (V72982) 913-3118-310 A9C22		1
	79	DM5E620J050WV	2 CAPACITOR,FXD, MICA DIEI, 62PF, 5%, 50V (V72136) 912-4141-320 A9C60		1

GROUP ASSEMBLY PARTS LIST

FIG - ITEM	PART NO	INDENT	DESCRIPTION	USABLE ON CODE	UNITS PER ASSY
4 80	913-3279-430	2	CAPACITOR,FXD, CER DIEL, 0.01PF, M20XP80X, 50V (V13499) 913-3279-430 A9C23		1
81	913-3279-430	2	CAPACITOR,FXD, CER DIEL, 0.01PF, M20XP80X, 50V (V13499) 913-3279-430 A9C24		1
82	RCR05G272K	2	RESISTOR,FXD, CMPSN, 2.7K, 10%, 1/8W (V81349) 745-2356-000 A9R53		1
83	RCR05G102K	2	RESISTOR,FXD, CMPSN, 1K, 10%, 1/8W (V81349) 745-2341-000 A9R46		1
84	8121-050-651-104 Z	2	CAPACITOR,FXD, CER DIEL, 0.1UF, M20XP80X, 50V (V72982) 913-3279-500 A9C13		1
85	913-3279-430	2	CAPACITOR,FXD, CER DIEL, 0.01PF, M20XP80X, 50V (V13499) 913-3279-430 A9C11		1
86	RCR05G104K	2	RESISTOR,FXD, CMPSN, 100K, 10%, 1/8W (V81349) 745-2413-000 A9R10		1
87	U5B770939	2	AMPLIFIER,OPR, (V07263) 351-7140-010 A9U62		1
88	T055-100-1F	2	RESISTOR,FXD, FILM, 100 OHMS, 1%, 1/8W (V11502) 705-1454-150 A9R9		1
89	913-3279-430	2	CAPACITOR,FXD, CER DIEL, 0.01PF, M20XP80X, 50V (V13499) 913-3279-430 A9C4		1
90	RCR05G152K	2	RESISTOR,FXD, CMPSN, 1.5K, 10%, 1/8W (V81349) 745-2347-000 A9R54		1
91	RCR05G104K	2	RESISTOR,FXD, CMPSN, 100K, 10%, 1/8W (V81349) 745-2413-000 A9R5		1
92	DM5C030D050WV	2	CAPACITOR,FXD, MICA DIEL, 3PF, 0.5PF, 50V (V72136) 912-4141-070 A9C6		1
93	U5B770939	2	AMPLIFIER,OPR, (V07263) 351-7140-010 A9U61		1
94	T055-100-1F	2	RESISTOR,FXD, FILM, 100 OHMS, 1%, 1/8W (V11502) 705-1454-150 A9R4		1
95	T055-100-1F	2	RESISTOR,FXD, FILM, 100 OHMS, 1%, 1/8W (V11502) 705-1454-150 A9R3		1
96	T055-100-1F	2	RESISTOR,FXD, FILM, 100 OHMS, 1%, 1/8W (V11502) 705-1454-150 A9R8		1
97	DM5C100D050WV	2	CAPACITOR,FXD, MICA DIEL, 10PF, 0.5PF, 50V (V72136) 912-4141-020 A9C5		1
98	T055-14-7K1F	2	RESISTOR,FXD, FILM, 14.7K, 1%, 1/8W (V11502) 705-1454-670 A9R2		1
99	T055-14-7K1F	2	RESISTOR,FXD, FILM, 14.7K, 1%, 1/8W (V11502) 705-1454-670 A9R1		1
100	913-3279-430	2	CAPACITOR,FXD, CER DIEL, 0.01PF, M20XP80X, 50V (V13499) 913-3279-430 A9C3		1
101	8131-100W5R104K	2	CAPACITOR,FXD, CER DIEL, 0.1UF, 10%, 100V (V72982) 913-3118-190 A9C2		1
102	8131-100W5R104K	2	CAPACITOR,FXD, CER DIEL, 0.1UF, 10%, 100V (V72982) 913-3118-190 A9C1		1
103	M39003-01-2073	2	CAPACITOR,FXD, ELCTLT, 47UF, 20%, 35V (V81349) 184-9083-730 A9C43		1
104	M39003-01-2073	2	CAPACITOR,FXD, ELCTLT, 47UF, 20%, 35V (V81349) 184-9083-730 A9C42		1
105	DM5C100D050WV	2	CAPACITOR,FXD, MICA DIEL, 10PF, 0.5PF, 50V (V72136) 912-4141-020 A9C12		1
106	RCR05G152K	2	RESISTOR,FXD, CMPSN, 1.5K, 10%, 1/8W (V81349) 745-2347-000 A9R55		1
107	913-3279-430	2	CAPACITOR,FXD, CER DIEL, 0.01PF, M20XP80X, 50V (V13499) 913-3279-430 A9C10		1
108	T055-13-1K1F	2	RESISTOR,FXD, FILM, 13.3K, 1%, 1/8W (V11502) 705-1454-660 A9R31		1
109	T055-10K1F	2	RESISTOR,FXD, FILM, 10K, 1%, 1/8W (V11502) 705-1454-630 A9R34		1
110	T055-10K1F	2	RESISTOR,FXD, FILM, 10K, 1%, 1/8W (V11502) 705-1454-630 A9R33		1
111	913-3279-430	2	CAPACITOR,FXD, CER DIEL, 0.01PF, M20XP80X, 50V (V13499) 913-3279-430 A9C31		1



## GROUP ASSEMBLY PARTS LIST

FIG - ITEM	PART NO	INDENT	DESCRIPTION	USABLE ON CODE	UNITS PER ASSY
4 112	RCR05G102K	2	RESISTOR,FXD, CMPSN, 1K, 10%, 1/8W (V81349) 745-2341-000 A9R44		1
113	2N2222A	2	TRANSISTOR, (V07688) 352-0661-020 A905		1
114	913-3279-430	2	CAPACITOR,FXD, CER DIEL, 0.01PF, M20XP80%, 50V (V13499) 913-3279-430 A9C30		1
115	RCR05G102K	2	RESISTOR,FXD, CMPSN, 1K, 10%, 1/8W (V81349) 745-2341-000 A9R42		1
116	2N2907A	2	TRANSISTOR, (V07688) 352-0551-010 A9Q6		1
117	1N963B	2	SEMICONV DEVICE, (V07688) 353-3174-000 A9CR11		1
118	B5171-150-2G	2	CLIP,ELEC, (V29593) 367-1508-010		2
119	372-2601-037	2	CONTACT,ELEC, 372-2601-037		10
120	372-2234-020	2	CONTACT,ELEC, (V13499) 372-2234-020		23
121	372-2234-010	2	CONTACT,ELEC, (V13499) 372-2234-010		24
122	372-2623-033	2	HOUSING,CONN,EL, 372-2623-033		1
123	774-7845-001	2	HANDLE		1
	MS171473	2	PIN,SPR, SST, 0.078 DIA X 15/16 (V96906) 311-0366-000 (AP)		1
5 -	793-9332-002	1	CIRCUIT CARD ASSY, SYNTHESIZER MIXER A12 (SEE FIG 1-12 FOR NHA)		RF
1	262C067222X0101B	2	CAPACITOR,FXD, CER DIEL, 2200PF, 20%, 150V (V56289) 913-5109-170 A12C4		1
2	SM153	2	INTEGRATED CKT, (V93332) 351-7417-010 A12U9		1
3	SF202	2	INTEGRATED CKT, (V93332) 351-7385-010 A12U5		1
4	262C067222X0101B	2	CAPACITOR,FXD, CER DIEL, 2200PF, 20%, 150V (V56289) 913-5109-170 A12C5		1
5	SG193	2	INTEGRATED CKT, (V93332) 351-7102-020 A12U6		1
6	SF203	2	INTEGRATED CKT, (V93332) 351-7385-020 A12U7		1
7	262C067222X0101B	2	CAPACITOR,FXD, CER DIEL, 2200PF, 20%, 150V (V56289) 913-5109-170 A12C3		1
8	SF33	2	INTEGRATED CKT, (V93332) 351-7106-020 A12U8		1
9	SF213	2	INTEGRATED CKT, (V93332) 351-7408-020 A12U2		1
10	262C067222X0101B	2	CAPACITOR,FXD, CER DIEL, 2200PF, 20%, 150V (V56289) 913-5109-170 A12C2		1
11	SF213	2	INTEGRATED CKT, (V93332) 351-7408-020 A12U3		1
12	SF212	2	INTEGRATED CKT, (V93332) 351-7408-010 A12U1		1
13	SG222	2	INTEGRATED CKT, (V93332) 351-7126-010 A12U11		1
14	SF213	2	INTEGRATED CKT, (V93332) 351-7408-020 A12U4		1
15	262C067222X0101B	2	CAPACITOR,FXD, CER DIEL, 2200PF, 20%, 150V (V56289) 913-5109-170 A12C7		1
16	240-2711-300	2	COIL,RF, 27UH (V99800) 240-2711-300 A12L2		1
17	240-2711-300	2	COIL,RF, 27UH (V99800) 240-2711-300 A12L3		1
18	240-2711-300	2	COIL,RF, 27UH (V99800) 240-2711-300 A12L4		1
18A	610-1957-004	2	PLATE,IDENT		1
18B	610-1957-001	2	PLATE,IDENT		1
19	793-9852-001	2	MIXER, LOOP 2, A12U13		1
20	793-9847-001	2	MIXER, LOOP 1, A12U12		1
	P330-3059-020	2	SCREW,MACH, STL, 2-56UNC2A X 3/16 (V77250) 330-3059-020 (AP FOR 19,20)		8
21	262C067222X0101B	2	CAPACITOR,FXD, CER DIEL, 2200PF, 20%, 150V (V56289) 913-5109-170 A12C8		1
22	M39003-01-2029	2	CAPACITOR,FXD, ELCTLT, 3.3UF, 20%, 15V (V81349) 184-9083-290 A12C1		1
23	MS18130-19	2	COIL,RF, 8.20UH (V96906) 240-1579-000 A12L1		1
24	262C067222X0101B	2	CAPACITOR,FXD, CER DIEL, 2200PF, 20%, 150V (V56289) 913-5109-170 A12C6		1

GROUP ASSEMBLY PARTS LIST

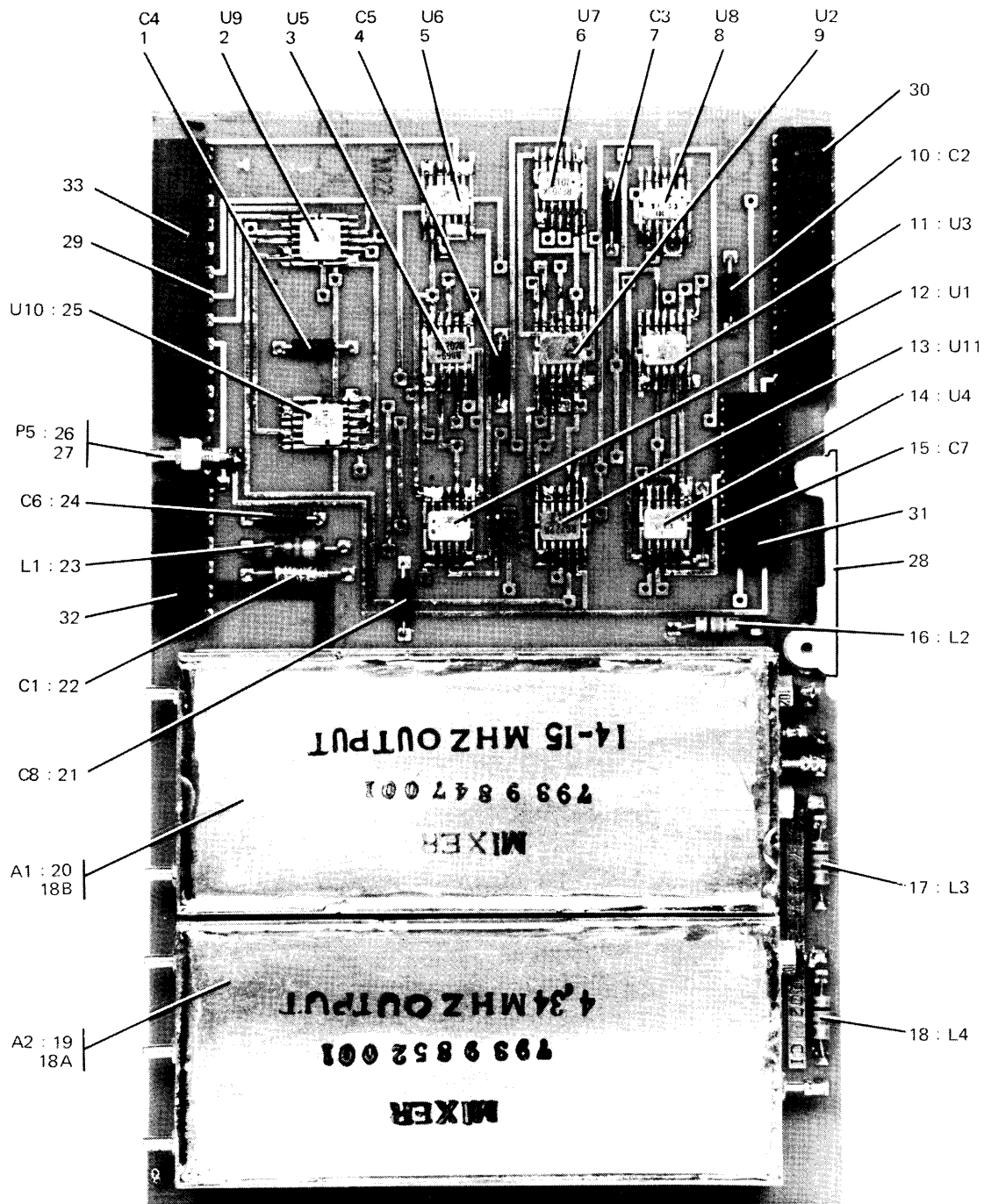

TP3-1054-017

Synthesizer Mixer Circuit Card Assembly (A12) 793-9332-002  
Figure 5

## GROUP ASSEMBLY PARTS LIST

FIG - ITEM	PART NO	INDENT	DESCRIPTION	USABLE ON CODE	UNITS PER ASSY
5	25	SM143	2 INTEGRATED CKT, (V93332) 351-7432-010 A12U10		1
	26	141-1002-0003	2 CONNECTOR, RCPT, ELEC (V98278) 357-7353-020 A12P19		1
	27	793-9822-001	2 HOUSING, CONNECTOR		1
	28	783-9535-001 MS51923-314	2 HANDLE		1
			2 PIN, SPRING, SST, 0.078 DIA X 1/4 (V96906) 311-0465-000 (AP)		1
	29	372-2234-010	2 CONTACT, ELEC, (V13499) 372-2234-010		36
	30	372-2621-020	2 HOUSING, CONN, 372-2621-020		1
	31	372-2621-016	2 HOUSING, CONN, 372-2621-016		1
	32	372-2621-015	2 HOUSING, CONN, 372-2621-015		1
	33	372-2621-021	2 HOUSING, CONN, 372-2621-021		1
6 -		793-9333-002	1 CIRCUIT CARD ASSY, SYNTHESIZER REFERENCE A11 (SEE FIG 1-13 FOR NHA)		RF
	1	CK05BX103K	2 CAPACITOR, FXD, CER DIEL, 0.01UF, 10%, 100V (V81349) 913-5019-200 A11C4		1
	2	CK05BX103K	2 CAPACITOR, FXD, CER DIEL, 0.01UF, 10%, 100V (V81349) 913-5019-200 A11C5		1
	3	21801MPORM5PCT 624-3524-001	2 COIL, RF, 18UH (V78526) 240-0887-060 A11L1		1
	4	RCR05G100K	2 RESISTOR KIT, TEST SELECT (NON-PROCURABLE ITEM)		1
			3 RESISTOR, FXD, CMPSN, 10 OHMS, 10%, 1/8W (V81349) 745-2268-000 A11R1		AR
	4	RCR05G120K	3 RESISTOR, FXD, CMPSN, 12 OHMS, 10%, 1/8W (V81349) 745-2271-000 A11R1		AR
	4	RCR05G150K	3 RESISTOR, FXD, CMPSN, 15 OHMS, 10%, 1/8W (V81349) 745-2274-000 A11R1		AR
	4	RCR05G180K	3 RESISTOR, FXD, CMPSN, 18 OHMS, 10%, 1/8W (V81349) 745-2277-000 A11R1		AR
	4	RCR05G220K	3 RESISTOR, FXD, CMPSN, 22 OHMS, 10%, 1/8W (V81349) 745-2280-000 A11R1		AR
	4	RCR05G270K	3 RESISTOR, FXD, CMPSN, 27 OHMS, 10%, 1/8W (V81349) 745-2283-000 A11R1		AR
	4	RCR05G330K	3 RESISTOR, FXD, CMPSN, 33 OHMS, 10%, 1/8W (V81349) 745-2286-000 A11R1		AR
	4	RCR05G390K	3 RESISTOR, FXD, CMPSN, 39 OHMS, 10%, 1/8W (V81349) 745-2289-000 A11R1		AR
	4	RCR05G470K	3 RESISTOR, FXD, CMPSN, 47 OHMS, 10%, 1/8W (V81349) 745-2292-000 A11R1		AR
	4	RCR05G560K	3 RESISTOR, FXD, CMPSN, 56 OHMS, 10%, 1/8W (V81349) 745-2295-000 A11R1		AR
	4	RCR05G680K	3 RESISTOR, FXD, CMPSN, 68 OHMS, 10%, 1/8W (V81349) 745-2298-000 A11R1		AR
	4	RCR05G820K	3 RESISTOR, FXD, CMPSN, 82 OHMS, 10%, 1/8W (V81349) 745-2301-000 A11R1		AR
	4	RCR05G101K	3 RESISTOR, FXD, CMPSN, 100 OHMS, 10%, 1/8W (V81349) 745-2304-000 A11R1		AR
	4	RCR05G121K	3 RESISTOR, FXD, CMPSN, 120 OHMS, 10%, 1/8W (V81349) 745-2308-000 A11R1		AR
	4	RCR05G151K	3 RESISTOR, FXD, CMPSN, 150 OHMS, 10%, 1/8W (V81349) 745-2311-000 A11R1		AR
	4	RCR05G181K	3 RESISTOR, FXD, CMPSN, 180 OHMS, 10%, 1/8W (V81349) 745-2314-000 A11R1		AR
	4	RCR05G221K	3 RESISTOR, FXD, CMPSN, 220 OHMS, 10%, 1/8W (V81349) 745-2317-000 A11R1		AR

GROUP ASSEMBLY PARTS LIST

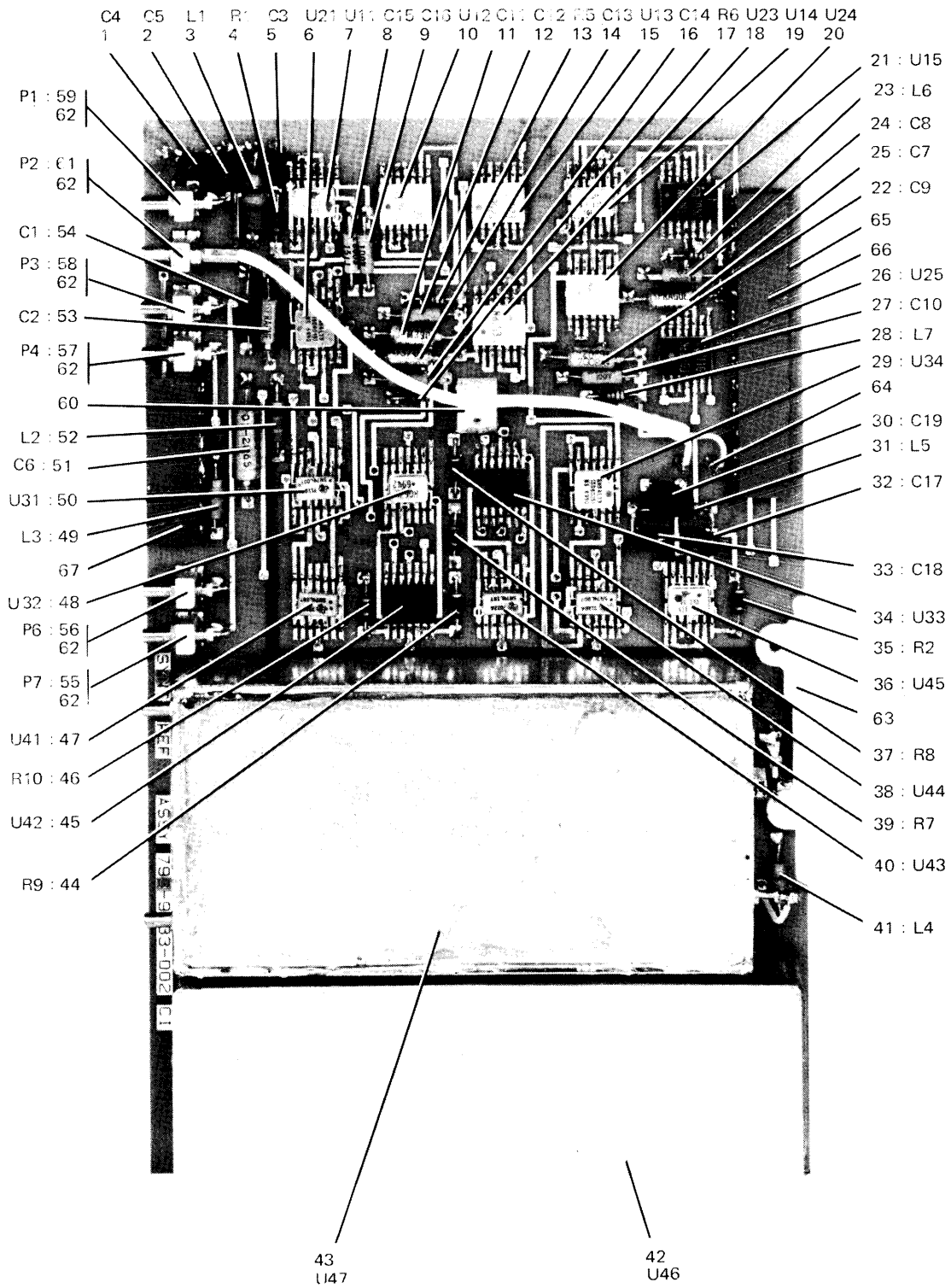

TP3-1053-017

Synthesizer Reference Circuit Card Assembly (A11) 793-9333-002  
Figure 6

## GROUP ASSEMBLY PARTS LIST

FIG - ITEM	PART NO	INDENT	DESCRIPTION	USABLE ON CODE	UNITS PER ASSY
6	4 RCR05G271K	3	RESISTOR,FXD, CMPSN, 270 OHMS, 10%, 1/8W (V81749) 745-2320-000 A11R1		AR
	4 RCR05G331K	3	RESISTOR,FXD, CMPSN, 330 OHMS, 10%, 1/8W (V81349) 745-2323-000 A11R1		AR
	5 CK05BX273K	2	CAPACITOR,FXD, CER DIEI, 0.027UF, 10%, 50V (V81349) 913-5019-250 A11C3		1
	6 SN74L02T	2	INTEGRATED CKT, (V01295) 351-7568-090 A11U21 (EFF TO CI 72186)		1
	6 SN74L73T	2	INTEGRATED CKT, (V01295) 351-7568-100 A11U21 (EFF CI 72186 TO CI 72213)		1
	6 SN7473W	2	INTEGRATED CKT, (V01295) 351-7588-030 A11U21 (EFF CI 72213)		1
	7 SG223	2	INTEGRATED CKT, (V93332) 351-7126-020 A11U11		1
	8 262C025151X5101B	2	CAPACITOR,FXD, CER DIEI, 150PF, 5%, 100V (V56289) 913-4490-180 A11C15		1
	9 262C025151X5101B	2	CAPACITOR,FXD, CER DIEI, 150PF, 5%, 100V (V56289) 913-4490-180 A11C16		1
	10 N8292Q	2	INTEGRATED CKT, (V18324) 351-7535-030 A11U12		1
	11 M39003-01-2029	2	CAPACITOR,FXD, ELCTLT, 3.3UF, 20%, 15V (V81349) 184-9083-290 A11C11		1
	12 262C067222X0101B	2	CAPACITOR,FXD, CER DIEI, 2200PF, 20%, 150V (V56289) 913-5109-170 A11C12		1
	13 RCR05G3R3JS	2	RESISTOR, FXD, CMPSN, 3.3 OHMS, 5%, 1/8W (V81349) 745-0907-130 A11R5		1
	14 M39003-01-2029	2	CAPACITOR,FXD, ELCTLT, 3.3UF, 20%, 15V (V81349) 184-9083-290 A11C13		1
	15 N8292Q	2	INTEGRATED CKT, (V18324) 351-7535-030 A11U13		1
	16 262C067222X0101B	2	CAPACITOR,FXD, CER DIEI, 2200PF, 20%, 150V (V56289) 913-5109-170 A11C14		1
	17 RCR05G3R3JS	2	RESISTOR, FXD, CMPSN, 3.3 OHMS, 5%, 1/8W (V81349) 745-0907-130 A11R6		1
	18 N8293Q	2	INTEGRATED CKT, (V18324) 351-7535-040 A11U23		1
	19 SF103	2	INTEGRATED CKT, (V93332) 351-7318-020 A11U14		1
	20 N8293Q	2	INTEGRATED CKT, (V18324) 351-7535-040 A11U24		1
	21 N8281J	2	INTEGRATED CKT, (V18324) 351-7340-040 A11U15		1
	22 M39003-01-2029	2	CAPACITOR,FXD, ELCTLT, 3.3UF, 20%, 15V (V81349) 184-9083-290 A11C9 (EFF TO CI 72246)		1
	22 M39003-01-2018	2	CAPACITOR,FXD, ELCTLT, 3.3UF, 20%, 10V (V81349) 184-9083-180 A11C9 (EFF CI 72246)		1
	23 RCR05G3R3JS	2	RESISTOR, FXD, CMPSN, 3.3 OHMS, 5%, 1/8W (V81349) 745-0907-130 A11R3 (EFF TO CI 72246)		1
	23 MS75084-16	2	COIL,RF, 22UH (V96906) 240-2039-000 A11L6 (EFF CI 72246)		1
	24 262C067222X0101B	2	CAPACITOR,FXD, CER DIEI, 2200PF, 20%, 150V (V56289) 913-5109-170 A11C8		1
	25 M39003-01-2029	2	CAPACITOR,FXD, ELCTLT, 3.3UF, 20%, 15V (V81349) 184-9083-290 A11C7		1
	26 N8280J	2	INTEGRATED CKT, (V18324) 351-7340-030 A11U25		1
	27 262C067222X0101B	2	CAPACITOR,FXD, CER DIEI, 2200PF, 20%, 150V (V56289) 913-5109-170 A11C10		1
	28 RCR05G3R3JS	2	RESISTOR, FXD, CMPSN, 3.3 OHMS, 5%, 1/8W (V81349) 745-0907-130 A11R4 (EFF TO CI 72246)		1
	28 MS75084-16	2	COIL,RF, 22UH (V96906) 240-2039-000 A11L7 (EFF CI 72246)		1
	29 SN74L02T	2	INTEGRATED CKT, (V01295) 351-7568-090 A11U34 (EFF TO CI 72186)		1
	29 SN74L73T	2	INTEGRATED CKT, (V01295) 351-7568-100 A11U34 (EFF CI 72186 TO CI 72213)		1
	29 SN7473W	2	INTEGRATED CKT, (V01295) 351-7588-030 A11U34 (EFF CI 72213)		1
	30 CK05BX103K	2	CAPACITOR,FXD, CER DIEI, 0.01UF, 10%, 100V (V81349) 913-5019-200 A11C19		1
	31 MS75084-02	2	COIL,RF, 1.50UH (V96906) 240-2025-000 A11L5		1

GROUP ASSEMBLY PARTS LIST

FIG - ITEM	PART NO	INDENT	DESCRIPTION	USABLE ON CODE	UNITS PER ASSY
6 32	DM5F331J050WV	2	CAPACITOR,FXD, MICA DIEI, 330PF, 5%, 50V (V72136) 912-4141-490 A11C17		1
33	DM5F331J050WV	2	CAPACITOR,FXD, MICA DIEI, 330PF, 5%, 50V (V72136) 912-4141-490 A11C18		1
34	N8424J	2	INTEGRATED CKT, (V1A324) 351-7717-010 A11U33		1
	624-3524-001	2	RESISTOR KIT, TEST SELECT (NON-PROCURABLE ITEM)		1
35	RCR05G100K	3	RESISTOR,FXD, CMPSN, 10 OHMS, 10%, 1/8W (V81349) 745-2268-000 A11R2		AR
35	RCR05G120K	3	RESISTOR,FXD, CMPSN, 12 OHMS, 10%, 1/8W (V81349) 745-2271-000 A11R2		AR
35	RCR05G150K	3	RESISTOR,FXD, CMPSN, 15 OHMS, 10%, 1/8W (V81349) 745-2274-000 A11R2		AR
35	RCR05G180K	3	RESISTOR,FXD, CMPSN, 18 OHMS, 10%, 1/8W (V81349) 745-2277-000 A11R2		AR
35	RCR05G220K	3	RESISTOR,FXD, CMPSN, 22 OHMS, 10%, 1/8W (V81349) 745-2280-000 A11R2		AR
35	RCR05G270K	3	RESISTOR,FXD, CMPSN, 27 OHMS, 10%, 1/8W (V81349) 745-2283-000 A11R2		AR
35	RCR05G330K	3	RESISTOR,FXD, CMPSN, 33 OHMS, 10%, 1/8W (V81349) 745-2286-000 A11R2		AR
35	RCR05G390K	3	RESISTOR,FXD, CMPSN, 39 OHMS, 10%, 1/8W (V81349) 745-2289-000 A11R2		AR
35	RCR05G470K	3	RESISTOR,FXD, CMPSN, 47 OHMS, 10%, 1/8W (V81349) 745-2292-000 A11R2		AR
35	RCR05G560K	3	RESISTOR,FXD, CMPSN, 56 OHMS, 10%, 1/8W (V81349) 745-2295-000 A11R2		AR
35	RCR05G680K	3	RESISTOR,FXD, CMPSN, 68 OHMS, 10%, 1/8W (V81349) 745-2298-000 A11R2		AR
35	RCR05G820K	3	RESISTOR,FXD, CMPSN, 82 OHMS, 10%, 1/8W (V81349) 745-2301-000 A11R2		AR
35	RCR05G101K	3	RESISTOR,FXD, CMPSN, 100 OHMS, 10%, 1/8W (V81349) 745-2304-000 A11R2		AR
35	RCR05G121K	3	RESISTOR,FXD, CMPSN, 120 OHMS, 10%, 1/8W (V81349) 745-2308-000 A11R2		AR
35	RCR05G151K	3	RESISTOR,FXD, CMPSN, 150 OHMS, 10%, 1/8W (V81349) 745-2311-000 A11R2		AR
35	RCR05G181K	3	RESISTOR,FXD, CMPSN, 180 OHMS, 10%, 1/8W (V81349) 745-2314-000 A11R2		AR
35	RCR05G221K	3	RESISTOR,FXD, CMPSN, 220 OHMS, 10%, 1/8W (V81349) 745-2317-000 A11R2		AR
35	RCR05G271K	3	RESISTOR,FXD, CMPSN, 270 OHMS, 10%, 1/8W (V81349) 745-2320-000 A11R2		AR
35	RCR05G331K	3	RESISTOR,FXD, CMPSN, 330 OHMS, 10%, 1/8W (V81349) 745-2323-000 A11R2		AR
36	SG223	2	INTEGRATED CKT, (V93332) 351-7126-020 A11U45		1
37	RCR05G472K	2	RESISTOR,FXD, CMPSN, 4.7K, 10%, 1/8W (V81349) 745-2365-000 A11R8		1
38	SN74L00T	2	INTEGRATED CKT, (V01295) 351-7568-050 A11U44 (EFF TO CI 72213)		1
38	SN7400W	2	INTEGRATED CKT, (V01295) 351-7389-030 A11U44 (EFF CI 72213)		1
39	RCR05G471K	2	RESISTOR,FXD, CMPSN, 470 OHMS, 10%, 1/8W (V81349) 745-2329-000 A11R7		1
40	SN74L10T	2	INTEGRATED CKT, (V01295) 351-7568-070 A11U43		1
41	240-2711-300	2	COIL,RF, 27UH (V99800) 240-2711-300 A11L4		1
42	609-0784-002	2	FREQUENCY STANDARD ASSY, 9.9 MHZ A11U46		1
	P330-3059-020	2	SCREW,MACH, STL, 2-56UNC2A X 3/16 (V77250)		4
	310-6320-000	2	WASHER,FLAT, SST, 0.092 ID X 0.218 OD (V79807) 310-6320-000 (AP)		4
43	789-8499-002	2	MULTIPLIER ASSY, X10 A11U47		1
	P330-3059-020	2	SCREW,MACH, STL, 2-56UNC2A X 3/16 (V77250) 330-3059-020 (AP)		4

GROUP ASSEMBLY PARTS LIST

FIG - ITEM	PART NO	INDENT	DESCRIPTION	USABLE ON CODE	UNITS PER ASSY
6	44	RCR05G471K	2 RESISTOR,FXD, CMPSN, 470 OHMS, 10%, 1/8W (V81349) 745-2329-000 A11R9		1
	45	N8424J	2 INTEGRATED CKT. (V18324) 351-7717-010 A11U42		1
	46	RCR05G472K	2 RESISTOR,FXD, CMPSN, 4.7K, 10%, 1/8W (V81349) 745-2365-000 A11R10		1
	47	SN74L10T	2 INTEGRATED CKT. (V01295) 351-7568-070 A11U41		1
	48	SG63	2 INTEGRATED CKT. (V93332) 351-7082-020 A11U32		1
	49	MS75084-08	2 COIL,RF, 4.70UH (V96906) 240-2031-000 A11L3		1
	50	SN74L00T	2 INTEGRATED CKT. (V01295) 351-7568-050 A11U31 (EFF TO CI 72213)		1
	50	SN7400W	2 INTEGRATED CKT. (V01295) 351-7389-030 A11U31 (EFF CI 72213)		1
	51	M39003-01-2065	2 CAPACITOR,FXD, ELCTLT, 6.8UF, 20%, 35V (V81349) 184-9083-650 A11C6		1
	52	MS75083-09	2 COIL,RF, 0.47UH (V96906) 240-2019-000 A11L2		1
	53	M39003-01-2029	2 CAPACITOR,FXD, ELCTLT, 3.3UF, 20%, 15V (V81349) 184-9083-290 A11C2		1
	54	262C067222X0101B	2 CAPACITOR,FXD, CER DIEL, 2200PF, 20%, 150V (V56289) 913-5109-170 A11C1		1
	55	141-1002-0003	2 CONNECTOR,RCPT, ELEC (V98278) 357-7353-020 A11P7		1
	56	141-1002-0003	2 CONNECTOR,RCPT, ELEC (V98278) 357-7353-020 A11P6		1
	57	141-1002-0003	2 CONNECTOR,RCPT, ELEC (V98278) 357-7353-020 A11P4		1
	58	141-1002-0003	2 CONNECTOR,RCPT, ELEC (V98278) 357-7353-020 A11P3		1
	59	141-1002-0003	2 CONNECTOR,RCPT, ELEC (V98278) 357-7353-020 A11P1		1
	60	789-8509-001	2 CLAMP,CABLE, (EFF TO CI 72466)		1
	60	768-7354-002	2 CLAMP,CABLE, (EFF CI 72466)		1
		P330-3059-020	2 SCREW,MACH, STL, 2-56UNC2A X 3/16 (V77250) 330-3059-020 (AP) (EFF TO CI 72466)		1
		P330-3059-030	2 SCREW,MACH, STL, 2-56UNC2A X 1/4 (V77250) 330-3059-030 (AP) (EFF CI 72466)		1
		303-1000-000	2 WASHER,NM, PLSTC, 0.125 ID X 0.281 OD (V79807) 303-1000-000 (AP) (EFF CI 72125)		1
	61	140-0530-9013	2 CABLE ASSY,ELEC, (V98278) 426-5435-200 A11P2		1
	62	793-9822-001	2 HOUSING, CONNECTOR		6
	63	783-9503-001	2 HANDLE		1
		MS51923-314	2 PIN,SPRING, SST, 0.078 DIA X 1/4 (V96906) 311-0465-000 (AP)		1
	64	372-2601-033	2 CONTACT,ELEC, 372-2601-033		2
	65	372-2234-010	2 CONTACT,ELEC, (V13499) 372-2234-010		20
	66	372-2621-022	2 HOUSING,CONN, 372-2621-022		1
	67	372-2621-016	2 HOUSING,CONN, 372-2621-016		1

GROUP ASSEMBLY PARTS LIST

(Figure 7 deleted.)

*Figure 7 Deleted.*



GROUP ASSEMBLY PARTS LIST

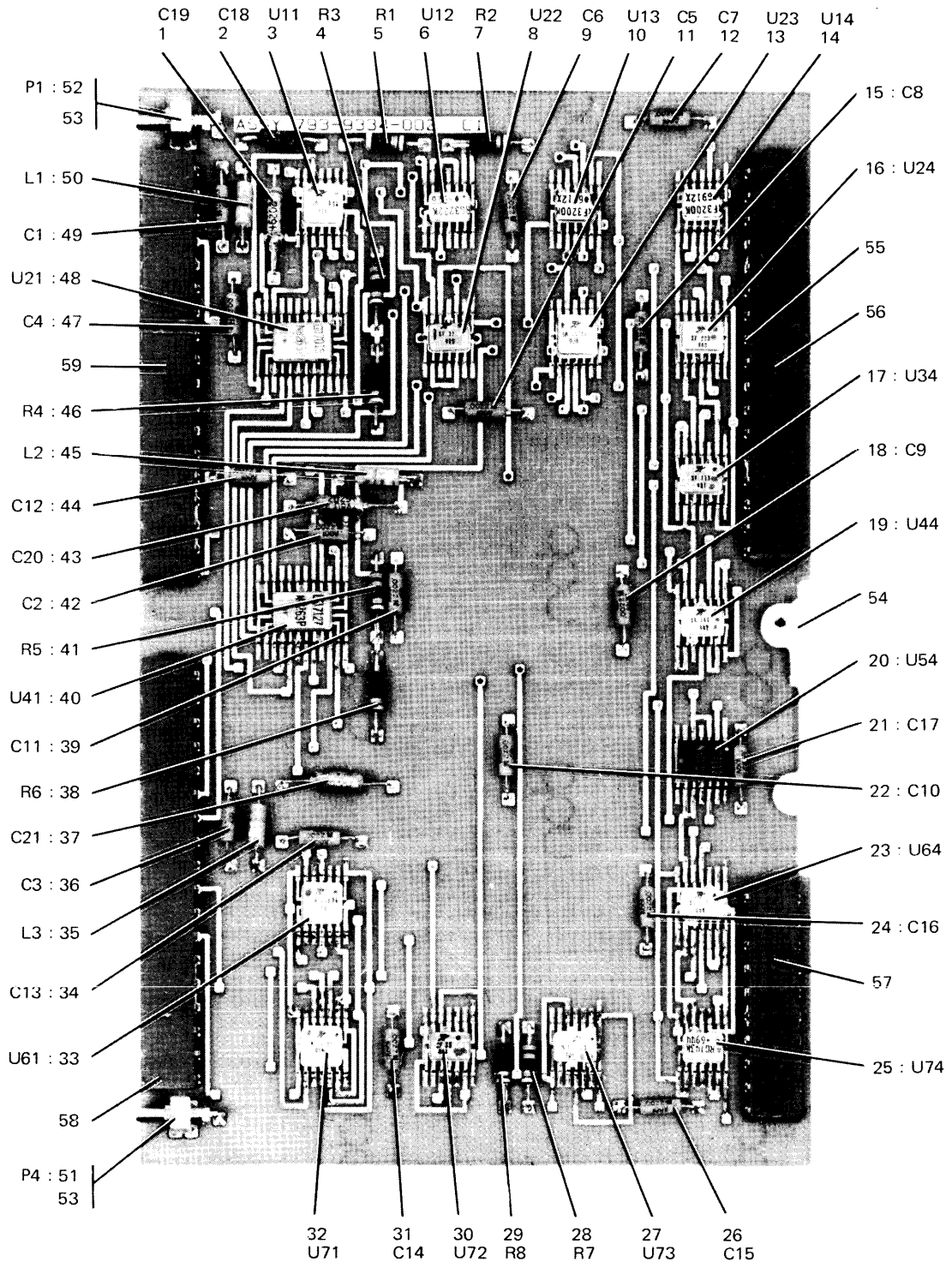

TP3-1051-017

Synthesizer Divider Circuit Card Assembly (A10) 793-9334-002  
Figure 8

Revised 1 October 1972

GROUP ASSEMBLY PARTS LIST

FIG - ITEM	PART NO	INDENT	DESCRIPTION	USABLE ON CODE	UNITS PER ASSY
8 -	793-9334-002	1	CIRCUIT CARD ASSY, SYNTHESIZER DIVIDER A10 (SEE FIG 1-14 FOR NHA)	A,B,C,D E,F,G,H K,L,M,N P,Q,X,Y Z,AA,AB AC,AD,AE AF,AG,AP AR,AS,AT AU,AW,AX	RF
1	M39003-01-2029	2	CAPACITOR,FXD, ELCTLT, 3.3UF, 20%, 15V (V81349) 184-9083-290 A10C19		1
2	262C067103X0101B	2	CAPACITOR,FXD, CER DIEI, 10,000PF, 20%, 150V (V56289) 913-5109-210 A10C18 (EFF TO CI 73026)		1
2	C22A103M	2	CAPACITOR,FXD, CER DIEI, 10000PF, 20%, 50V (V16546) 913-5642-000 A10C18 (EFF CI 73026)		1
3	SM153	2	INTEGRATED CKT, (V93332) 351-7417-010 A10U11		1
4	RCR07G332KS	2	RESISTOR,FXD, CMPSN, 3.3K, 10%, 1/4W (V81349) 745-0767-000 A10R3		1
5	RCR07G472KS	2	RESISTOR,FXD, CMPSN, 4.7K, 10%, 1/4W (V81349) 745-0773-000 A10R1		1
6	RG3222K	2	INTEGRATED CKT, (V49956) 351-7474-030 A10U12		1
7	RCR07G102KS	2	RESISTOR,FXD, CMPSN, 1K, 10%, 1/4W (V81349) 745-0749-000 A10R2		1
8	SF33	2	INTEGRATED CKT, (V93332) 351-7106-020 A10U22		1
9	262C067222X0101B	2	CAPACITOR,FXD, CER DIEI, 2200PF, 20%, 150V (V56289) 913-5109-170 A10C6		1
10	RF3202K	2	INTEGRATED CKT, (V49956) 351-7472-030 A10U13		1
11	262C067222X0101B	2	CAPACITOR,FXD, CER DIEI, 2200PF, 20%, 150V (V56289) 913-5109-170 A10C5		1
12	262C067222X0101B	2	CAPACITOR,FXD, CER DIEI, 2200PF, 20%, 150V (V56289) 913-5109-170 A10C7		1
13	SM153	2	INTEGRATED CKT, (V93332) 351-7417-010 A10U23		1
14	RF3202K	2	INTEGRATED CKT, (V49956) 351-7472-030 A10U14		1
15	262C067222X0101B	2	CAPACITOR,FXD, CER DIEI, 2200PF, 20%, 150V (V56289) 913-5109-170 A10C8		1
16	SF203	2	INTEGRATED CKT, (V93332) 351-7385-020 A10U24		1
17	SF113	2	INTEGRATED CKT, (V93332) 351-7331-020 A10U34		1
18	262C067222X0101B	2	CAPACITOR,FXD, CER DIEI, 2200PF, 20%, 150V (V56289) 913-5109-170 A10C9		1
19	SG143	2	INTEGRATED CKT, (V93332) 351-7094-020 A10U44		1
20	N8280J	2	INTEGRATED CKT, (V18324) 351-7340-030 A10U54		1
21	262C067222X0101B	2	CAPACITOR,FXD, CER DIEI, 2200PF, 20%, 150V (V56289) 913-5109-170 A10C17		1
22	262C067222X0101B	2	CAPACITOR,FXD, CER DIEI, 2200PF, 20%, 150V (V56289) 913-5109-170 A10C10		1
23	SG193	2	INTEGRATED CKT, (V93332) 351-7102-020 A10U64		1
24	262C067222X0101B	2	CAPACITOR,FXD, CER DIEI, 2200PF, 20%, 150V (V56289) 913-5109-170 A10C16		1
25	SG143	2	INTEGRATED CKT, (V93332) 351-7094-020 A10U74		1
26	262C067222X0101B	2	CAPACITOR,FXD, CER DIEI, 2200PF, 20%, 150V (V56289) 913-5109-170 A10C15		1
27	SF113	2	INTEGRATED CKT, (V93332) 351-7331-020 A10U73		1
28	RCR07G332KS	2	RESISTOR,FXD, CMPSN, 3.3K, 10%, 1/4W (V81349) 745-0767-000 A10R7		1
29	RCR07G822KS	2	RESISTOR,FXD, CMPSN, 8.2K, 10%, 1/4W (V81349) 745-0782-000 A10R8		1
30	SF33	2	INTEGRATED CKT, (V93332) 351-7106-020 A10U72		1
31	262C067222X0101B	2	CAPACITOR,FXD, CER DIEI, 2200PF, 20%, 150V (V56289) 913-5109-170 A10C14		1
32	SM153	2	INTEGRATED CKT, (V93332) 351-7417-010 A10U71		1
33	SM153	2	INTEGRATED CKT, (V93332) 351-7417-010 A10U61		1
34	262C067222X0101B	2	CAPACITOR,FXD, CER DIEI, 2200PF, 20%, 150V (V56289) 913-5109-170 A10C13		1
35	MS75084-07	2	COIL,RF, 3.90UH (V96906) 240-2030-000 A10L3		1
36	262C067222X0101B	2	CAPACITOR,FXD, CER DIEI, 2200PF, 20%, 150V (V56289) 913-5109-170 A10C3		1
37	M39003-01-2029	2	CAPACITOR,FXD, ELCTLT, 3.3UF, 20%, 15V (V81349) 184-9083-290 A10C21		1

GROUP ASSEMBLY PARTS LIST

FIG - ITEM	PART NO	INDENT	DESCRIPTION	USABLE ON CODE	UNITS PER ASSY
8	38	RCR07G822KS	2 RESISTOR,FXD, CMPSN, 8.2K, 10%, 1/4W (V81349) 745-0782-000 A10R6		1
	39	262C067222X0101B	2 CAPACITOR,FXD, CER DIEI, 2200PF, 20%, 150V (V56289) 913-5109-170 A10C11		1
	40	N8263P	2 INTEGRATED CKT, (V18324) 351-7716-010 A10U41		1
	41	RCR07G332KS	2 RESISTOR,FXD, CMPSN, 3.3K, 10%, 1/4W (V81349) 745-0767-000 A10R5		1
	42	262C067222X0101B	2 CAPACITOR,FXD, CER DIEI, 2200PF, 20%, 150V (V56289) 913-5109-170 A10C2		1
	43	M39003-01-2029	2 CAPACITOR,FXD, ELCTLT, 3.3UF, 20%, 15V (V81349) 184-9083-290 A10C20		1
	44	262C067222X0101B	2 CAPACITOR,FXD, CER DIEI, 2200PF, 20%, 150V (V56289) 913-5109-170 A10C12		1
	45	MS75084-07	2 COIL,RF, 3.90UH (V96906) 240-2030-000 A10L2		1
	46	RCR07G822KS	2 RESISTOR,FXD, CMPSN, 8.2K, 10%, 1/4W (V81349) 745-0782-000 A10R4		1
	47	262C067222X0101B	2 CAPACITOR,FXD, CER DIEI, 2200PF, 20%, 150V (V56289) 913-5109-170 A10C4		1
	48	N8263P	2 INTEGRATED CKT, (V18324) 351-7716-010 A10U21		1
	49	262C067222X0101B	2 CAPACITOR,FXD, CER DIEI, 2200PF, 20%, 150V (V56289) 913-5109-170 A10C1		1
	50	MS75084-07	2 COIL,RF, 3.90UH (V96906) 240-2030-000 A10L1		1
	51	141-1002-0003	2 CONNECTOR,RCPT, ELEC (V98278) 357-7353-020 A10P4		1
	52	141-1002-0003	2 CONNECTOR,RCPT, ELEC (V98278) 357-7353-020 A10P1		1
	53	793-9822-001	2 HOUSING, CONNECTOR		2
	54	783-9506-001	2 HANDLE		1
		MS51923-314	2 PIN,SPRING, SST, 0.078 DIA X 1/4 (V96906) 311-0465-000 (AP)		1
	55	372-2234-010	2 CONTACT,ELEC, (V13499) 372-2234-010		63
	56	372-2621-026	2 HOUSING,CONN, 372-2621-026		1
	57	372-2621-019	2 HOUSING,CONN, 372-2621-019		1
	58	372-2621-027	2 HOUSING,CONN, 372-2621-027		1
	59	372-2621-027	2 HOUSING,CONN, 372-2621-027		1
9		793-9334-006	1 CIRCUIT CARD ASSY, SYNTHESIZER DIVIDER A10 (SEE FIG 1-14 FOR NHA)	J,AM,AN AQ,AV	RF
	1	MS75084-07	2 COIL,RF, 3.90UH (V96906) 240-2030-000 A10L1		1
	2	M39003-01-2029	2 CAPACITOR,FXD, ELCTLT, 3.3UF, 20%, 15V (V81349) 184-9083-290 A10C19		1
	3	262C067103X0101B	2 CAPACITOR,FXD, CER DIEI, 10,000PF, 20%, 150V (V56289) 913-5109-210 A10C18 (EFF TO CI 73026)		1
	3	C22A103M	2 CAPACITOR,FXD, CER DIEI, 10000PF, 20%, 50V (V16346) 913-5642-000 A10C18 (EFF CI 73026)		1
	4	SM153	2 INTEGRATED CKT, (V93332) 351-7417-010 A10U11		1
	5	RCR07G332KS	2 RESISTOR,FXD, CMPSN, 3.3K, 10%, 1/4W (V81349) 745-0767-000 A10R3		1
	6	RCR07G472KS	2 RESISTOR,FXD, CMPSN, 4.7K, 10%, 1/4W (V81349) 745-0773-000 A10R1		1
	7	RG3222K	2 INTEGRATED CKT, (V49956) 351-7474-030 A10U12		1
	8	RCR07G102KS	2 RESISTOR,FXD, CMPSN, 1K, 10%, 1/4W (V81349) 745-0749-000 A10R2		1
	9	SF33	2 INTEGRATED CKT, (V93332) 351-7106-020 A10U22		1
	10	262C067222X0101B	2 CAPACITOR,FXD, CER DIEI, 2200PF, 20%, 150V (V56289) 913-5109-170 A10C6		1
	11	RF3202K	2 INTEGRATED CKT, (V49956) 351-7472-030 A10U13		1
	12	262C067222X0101B	2 CAPACITOR,FXD, CER DIEI, 2200PF, 20%, 150V (V56289) 913-5109-170 A10C7		1
	13	RF3202K	2 INTEGRATED CKT, (V49956) 351-7472-030 A10U14		1
	14	SM153	2 INTEGRATED CKT, (V93332) 351-7417-010 A10U23		1
	15	262C067222X0101B	2 CAPACITOR,FXD, CER DIEI, 2200PF, 20%, 150V (V56289) 913-5109-170 A10C8		1
	16	SF203	2 INTEGRATED CKT, (V93332) 351-7385-020 A10U24		1
	17	262C067222X0101B	2 CAPACITOR,FXD, CER DIEI, 2200PF, 20%, 150V (V56289) 913-5109-170 A10C5		1
	18	SN74L00T	2 INTEGRATED CKT, (V01295) 351-7568-050 A10U33		1

GROUP ASSEMBLY PARTS LIST

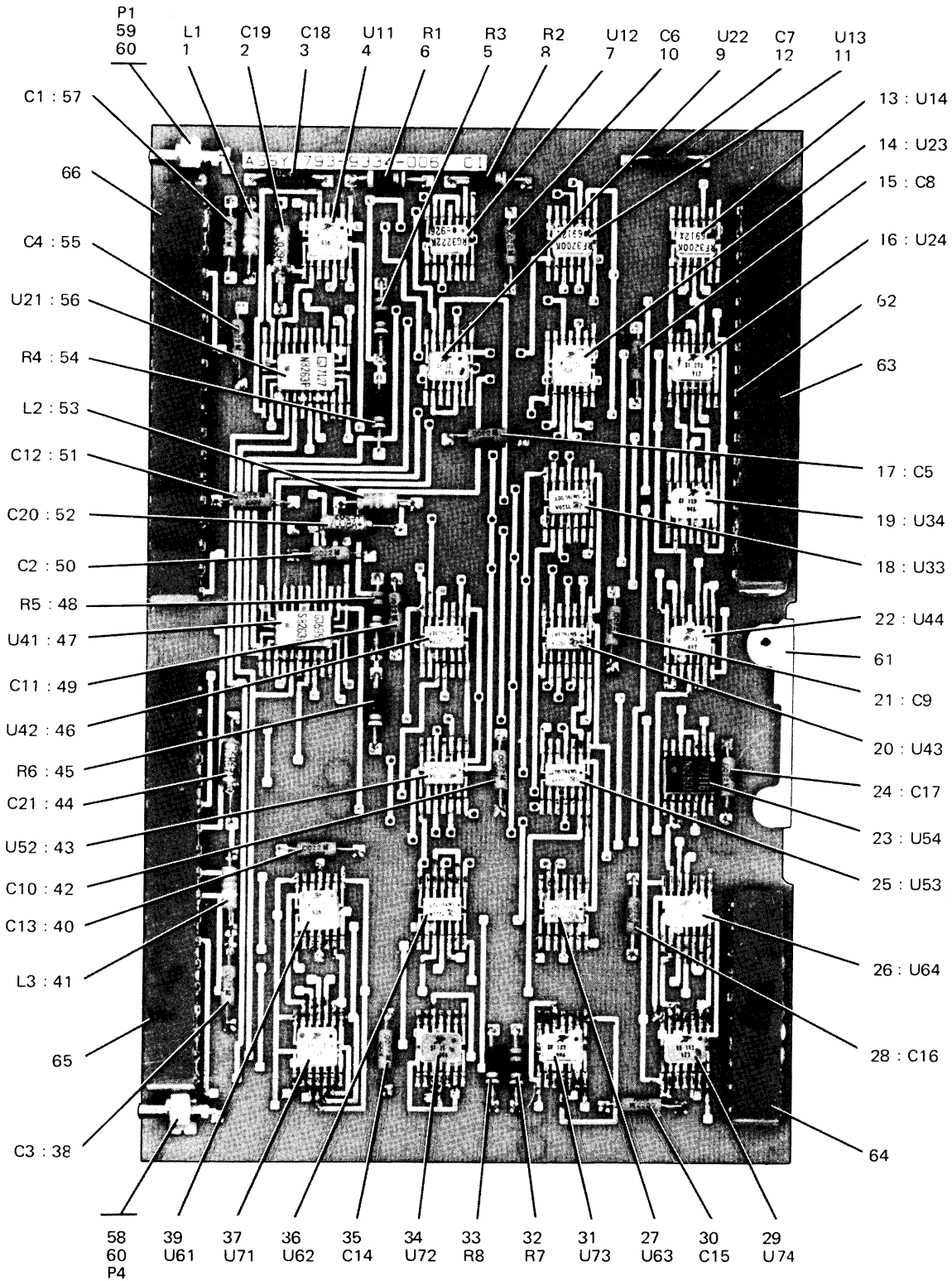

TP3-1050-017

Synthesizer Divider Circuit Card Assembly (A10) 793-9334-006  
Figure 9

## GROUP ASSEMBLY PARTS LIST

FIG - ITEM	PART NO	INDENT	DESCRIPTION	USABLE ON CODE	UNITS PER ASSY
9	19	SF113	2 INTEGRATED CKT. (V93332) 351-7331-020 A10U34		1
	20	SN74L10T	2 INTEGRATED CKT. (V01295) 351-7568-070 A10U43		1
	21	262C067222X0101B	2 CAPACITOR,FXD, CER DIEL, 2200PF, 20%, 150V (V56289) 913-5109-170 A10C9		1
	22	SG143	2 INTEGRATED CKT. (V93332) 351-7094-020 A10U44		1
	23	N8280J	2 INTEGRATED CKT. (V18324) 351-7340-030 A10U54		1
	24	262C067222X0101B	2 CAPACITOR,FXD, CER DIEL, 2200PF, 20%, 150V (V56289) 913-5109-170 A10C17		1
	25	SN74L00T	2 INTEGRATED CKT. (V01295) 351-7568-050 A10U53		1
	26	SG193	2 INTEGRATED CKT. (V93332) 351-7102-020 A10U64		1
	27	SN74L04T	2 INTEGRATED CKT. (V01295) 351-7568-060 A10U63		1
	28	262C067222X0101B	2 CAPACITOR,FXD, CER DIEL, 2200PF, 20%, 150V (V56289) 913-5109-170 A10C16		1
	29	SG143	2 INTEGRATED CKT. (V93332) 351-7094-020 A10U74		1
	30	262C067222X0101B	2 CAPACITOR,FXD, CER DIEL, 2200PF, 20%, 150V (V56289) 913-5109-170 A10C15		1
	31	SF113	2 INTEGRATED CKT. (V93332) 351-7331-020 A10U73		1
	32	RCR07G332KS	2 RESISTOR,FXD, CMPSN, 3.3K, 10%, 1/4W (V81349) 745-0767-000 A10R7		1
	33	RCR07G822KS	2 RESISTOR,FXD, CMPSN, 8.2K, 10%, 1/4W (V81349) 745-0782-000 A10R8		1
	34	SF33	2 INTEGRATED CKT. (V93332) 351-7106-020 A10U72		1
	35	262C067222X0101B	2 CAPACITOR,FXD, CER DIEL, 2200PF, 20%, 150V (V56289) 913-5109-170 A10C14		1
	36	SN74L00T	2 INTEGRATED CKT. (V01295) 351-7568-050 A10U62		1
	37	SM153	2 INTEGRATED CKT. (V93332) 351-7417-010 A10U71		1
	38	262C067222X0101B	2 CAPACITOR,FXD, CER DIEL, 2200PF, 20%, 150V (V56289) 913-5109-170 A10C3		1
	39	SM153	2 INTEGRATED CKT. (V93332) 351-7417-010 A10U61		1
	40	262C067222X0101B	2 CAPACITOR,FXD, CER DIEL, 2200PF, 20%, 150V (V56289) 913-5109-170 A10C13		1
	41	MS75084-07	2 COIL,RF, 3.90UH (V96906) 240-2030-000 A10L3		1
	42	262C067222X0101B	2 CAPACITOR,FXD, CER DIEL, 2200PF, 20%, 150V (V56289) 913-5109-170 A10C10		1
	43	SN74L04T	2 INTEGRATED CKT. (V01295) 351-7568-060 A10U52		1
	44	M39003-01-2029	2 CAPACITOR,FXD, ELCTLT, 3.3UF, 20%, 15V (V81349) 184-9083-290 A10C21		1
	45	RCR07G822KS	2 RESISTOR,FXD, CMPSN, 8.2K, 10%, 1/4W (V81349) 745-0782-000 A10R6		1
	46	SN74L00T	2 INTEGRATED CKT. (V01295) 351-7568-050 A10U42		1
	47	N8263P	2 INTEGRATED CKT. (V18324) 351-7716-010 A10U41		1
	48	RCR07G332KS	2 RESISTOR,FXD, CMPSN, 3.3K, 10%, 1/4W (V81349) 745-0767-000 A10R5		1
	49	262C067222X0101B	2 CAPACITOR,FXD, CER DIEL, 2200PF, 20%, 150V (V56289) 913-5109-170 A10C11		1
	50	262C067222X0101B	2 CAPACITOR,FXD, CER DIEL, 2200PF, 20%, 150V (V56289) 913-5109-170 A10C2		1
	51	262C067222X0101B	2 CAPACITOR,FXD, CER DIEL, 2200PF, 20%, 150V (V56289) 913-5109-170 A10C12		1
	52	M39003-01-2029	2 CAPACITOR,FXD, ELCTLT, 3.3UF, 20%, 15V (V81349) 184-9083-290 A10C20		1
	53	MS75084-07	2 COIL,RF, 3.90UH (V96906) 240-2030-000 A10L2		1
	54	RCR07G822KS	2 RESISTOR,FXD, CMPSN, 8.2K, 10%, 1/4W (V81349) 745-0782-000 A10R4		1
	55	262C067222X0101B	2 CAPACITOR,FXD, CER DIEL, 2200PF, 20%, 150V (V56289) 913-5109-170 A10C4		1
	56	N8263P	2 INTEGRATED CKT. (V18324) 351-7716-010 A10U21		1
	57	262C067222X0101B	2 CAPACITOR,FXD, CER DIEL, 2200PF, 20%, 150V (V56289) 913-5109-170 A10C1		1
	58	141-1002-0003	2 CONNECTOR,RCPT, ELEC (V98278) 357-7353-020 A10P4		1
	59	141-1002-0003	2 CONNECTOR,RCPT, ELEC (V98278) 357-7353-020 A10P1		1
	60	793-9822-001	2 HOUSING, CONNECTOR		2
	61	783-9504-001	2 HANDLE		1

GROUP ASSEMBLY PARTS LIST

FIG - ITEM	PART NO	INDENT	DESCRIPTION	USABLE ON CODE	UNITS PER ASSY
9	M851923-314	2	PIN, SPRING, SST, 0.078 DIA X 1/4 (V96906) 311-0465-000 (AP)		1
62	372-2234-010	2	CONTACT, ELEC. (V13499) 372-2234-010		63
63	372-2621-026	2	HOUSING, CONN. 372-2621-026		1
64	372-2621-019	2	HOUSING, CONN. 372-2621-019		1
65	372-2621-027	2	HOUSING, CONN. 372-2621-027		1
66	372-2621-027	2	HOUSING, CONN. 372-2621-027		1

GROUP ASSEMBLY PARTS LIST

(Figure 10 deleted.)

*Figure 10 Deleted.*

GROUP ASSEMBLY PARTS LIST

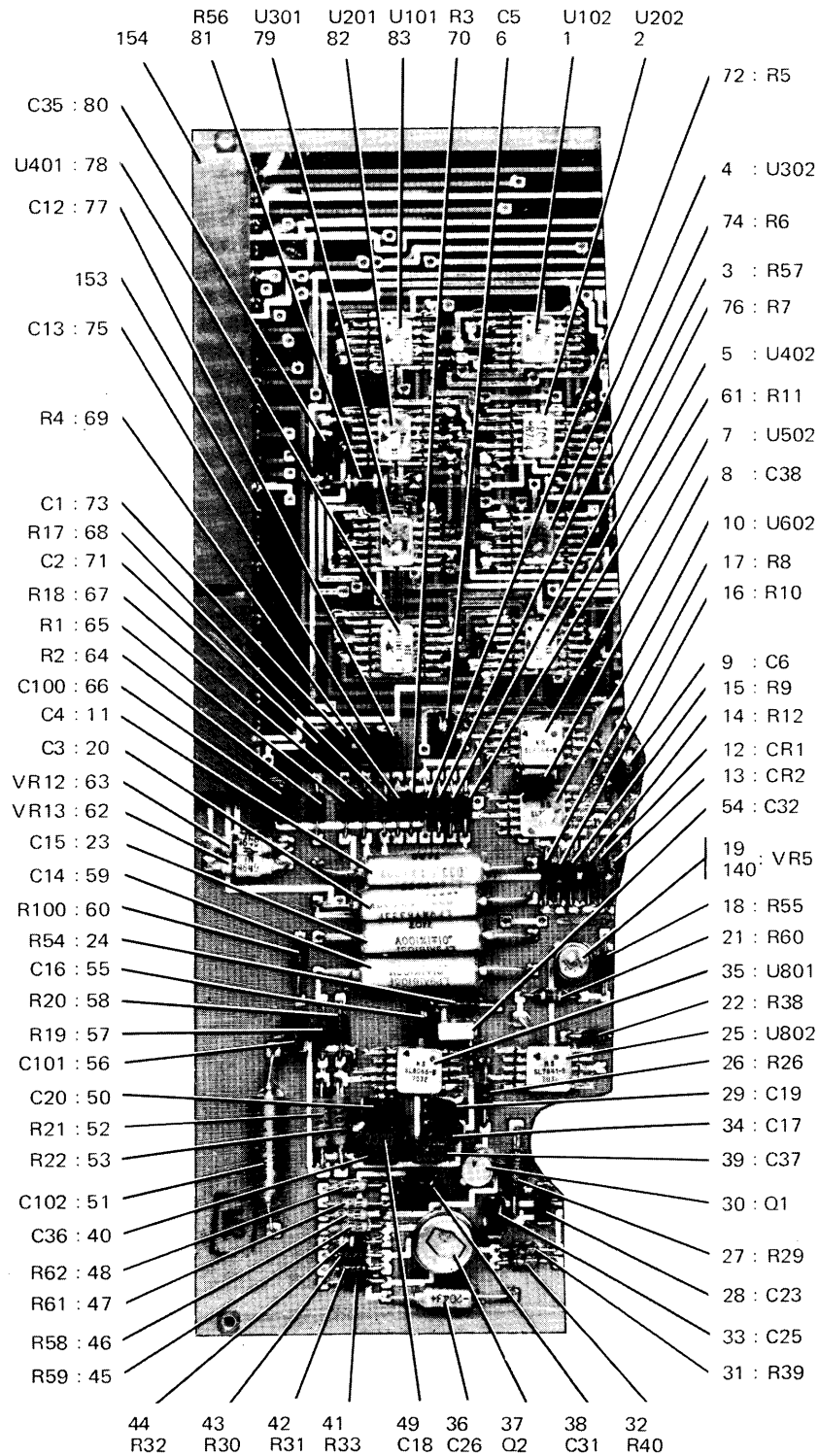

TP3-1048-027

DCU Circuit Card Assembly (A9) 793-9414-001  
Figure 11 (Sheet 1 of 2)



GROUP ASSEMBLY PARTS LIST

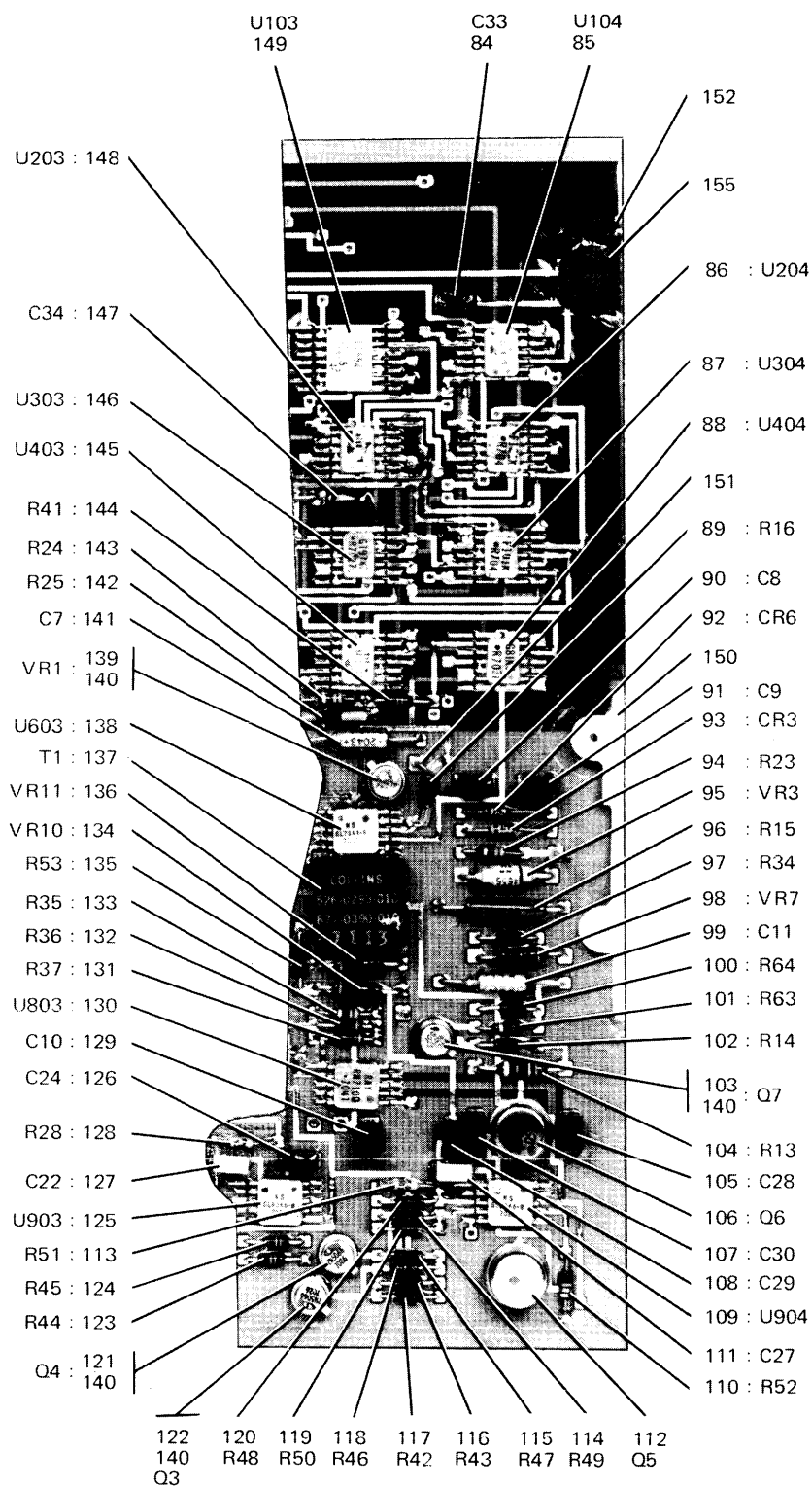

TP3-1048-027

DCU Circuit Card Assembly (A9) 793-9414-001  
Figure 11 (Sheet 2 of 2)

GROUP ASSEMBLY PARTS LIST

FIG - ITEM	PART NO	INDENT	DESCRIPTION	USABLE ON CODE	UNITS PER ASSY
11 *	793-9414-001	1	CIRCUIT CARD ASSY, DCU A9 (SEE FIG 1-15 FOR NHA)	B, E, F, P X, Z AB	RF
1	RF100K	2	INTEGRATED CKT, (V49956) 351-7297-010 A9U102		1
2	RF101K	2	INTEGRATED CKT, (V49956) 351-7297-020 A9U202		1
3	RCR07G392JS	2	RESISTOR, FXD, CMPSN, 3.9K, 5%, 1/4W (V81349) 745-0769-000 A9R57		1
4	RG371K	2	INTEGRATED CKT, (V49956) 351-7495-020 A9U302		1
5	CF81	2	INTEGRATED CKT, (V04713) 351-7484-010 A9U402		1
6	DM5C030D050WV	2	CAPACITOR, FXD, MICA DIEI, 3PF, 0.5PF, 50V (V72136) 912-4141-070 A9C5		1
7	LM101AF	2	INTEGRATED CKT, (V27014) 351-1040-010 A9U502		1
8	CK05BX104M	2	CAPACITOR, FXD, CER DIEI, 0.1UF, 20%, 50V (V81349) 913-5019-720 A9C38		1
9	DM5C150D050WV	2	CAPACITOR, FXD, MICA DIEI, 15PF, 0.5PF, 50V (V72136) 912-4141-130 A9C6		1
10	LM101F	2	INTEGRATED CKT, (V27014) 351-1031-010 A9U602		1
11	LP9A1B333F	2	CAPACITOR, FXD, PLSTC DIEI, 0.033UF, 1%, 100V (V01884) 933-1043-850 A9C4		1
12	1N4150	2	SEMICONV DEVICE, (V81350) 353-9008-100 A9CR1		1
13	1N4150	2	SEMICONV DEVICE, (V81350) 353-9008-100 A9CR2		1
14	RN50C1002F	2	RESISTOR, FXD, FILM, 10K, 1%, 1/20W (V81349) 705-3163-120 A9R12		1
15	RN50C3161F	2	RESISTOR, FXD, FILM, 3160 OHMS, 1%, 1/2W (V81349) 705-3162-870 A9R9		1
16	RCR05G272JS	2	RESISTOR, FXD, CMPSN, 2.7K, 5%, 1/8W (V81349) 745-1863-590 A9R10		1
17	C3112G	2	RESISTOR, FXD, FILM, 1.1K, 2%, 1/8W (V24546) 705-3161-500 A9R8		1
18	RN50C1000F	2	RESISTOR, FXD, FILM, 100 OHMS, 1%, 1/2W (V81349) 705-3162-150 A9R55		1
19	LM103H3-9	2	INTEGRATED CKT, (V27014) 351-1075-060 A9VR5		1
20	LP9A1B333F	2	CAPACITOR, FXD, PLSTC DIEI, 0.033UF, 1%, 100V (V01884) 933-1043-850 A9C3		1
21	RCR05G332K	2	RESISTOR, FXD, CMPSN, 3.3K, 10%, 1/8W (V81349) 745-2359-000 A9R60		1
22	C3431G	2	RESISTOR, FXD, FILM, 430 OHMS, 2%, 1/8W (V24546) 705-3161-400 A9R38		1
23	LP9A1B103F	2	CAPACITOR, FXD, PLSTC DIEI, 0.01UF, 1%, 100V (V01884) 933-1088-020 A9C15		1
24	C3103G	2	RESISTOR, FXD, FILM, 10K, 2%, 1/8W (V24546) 705-3161-730 A9R54		1
25	LM101F	2	INTEGRATED CKT, (V27014) 351-1031-010 A9U802		1
26	C3103G	2	RESISTOR, FXD, FILM, 10K, 2%, 1/8W (V24546) 705-3161-730 A9R26		1
27	T055-215K1F	2	RESISTOR, FXD, FILM, 215K, 1%, 1/8W (V11502) 705-1454-950 A9R29		1

## GROUP ASSEMBLY PARTS LIST

FIG - ITEM	PART NO	INDENT	DESCRIPTION	USABLE ON CODE	UNITS PER ASSY
11	28	8123-000C0G0221F	2 CAPACITOR,FXD, CER DIEI, 0.00022UF, 1%, 100V (V72982) 913-3117-180 A9C23		1
	29	CK058X103M	2 CAPACITOR,FXD, CER DIEI, 0.01UF, 20%, 100V (V81349) 913-5019-660 A9C19		1
	30	F5379	2 TRANSISTOR, (V22229) 352-0972-010 A901		1
	31	RN50C2741F	2 RESISTOR,FXD, FILM, 2740 OHMS, 1%, 1/2W (V81349) 705-3162-840 A9R39		1
	32	RN50C2741F	2 RESISTOR,FXD, FILM, 2740 OHMS, 1%, 1/2W (V81349) 705-3162-840 A9R40		1
	33	CK058X103M	2 CAPACITOR,FXD, CER DIEI, 0.01UF, 20%, 100V (V81349) 913-5019-660 A9C25		1
	34	8123A1B8C0G471F	2 CAPACITOR,FXD, CER DIEI, 0.00047UF, 1%, 50V (V72982) 913-3117-210 A9C17		1
	35	LM101AF	2 INTEGRATED CKT, (V27014) 351-1040-010 A9U801		1
	36	M39003-01-2043	2 CAPACITOR,FXD, ELCTLT, 2.2UF, 10%, 20V (V81349) 184-9083-430 A9C26		1
	37	2N4045	2 TRANSISTOR, (V07688) 351-0011-040 A9Q2		1
	38	CK058X104M	2 CAPACITOR,FXD, CER DIEI, 0.1UF, 20%, 50V (V81349) 913-5019-720 A9C31		1
	39	8123A1B8C0G471F	2 CAPACITOR,FXD, CER DIEI, 0.00047UF, 1%, 50V (V72982) 913-3117-210 A9C37		1
	40	8123A1B8C0G471F	2 CAPACITOR,FXD, CER DIEI, 0.00047UF, 1%, 50V (V72982) 913-3117-210 A9C36		1
	41	C3103G	2 RESISTOR,FXD, FILM, 10K, 2%, 1/8W (V24546) 705-3161-730 A9R33		1
	42	RN50C1272F	2 RESISTOR,FXD, FILM, 12.7K, 1%, 1/20W (V81349) 705-3163-170 A9R31		1
	43	RN50C1541F	2 RESISTOR,FXD, FILM, 1540 OHMS, 1%, 1/2W (V81349) 705-3162-720 A9R30		1
	44	RCR05G104JS	2 RESISTOR,FXD, CMPSN, 100K, 5%, 1/8W (V81349) 745-1864-010 A9R32		1
	45	RN50C2672F	2 RESISTOR,FXD, FILM, 26.7K, 1%, 1/20W (V81349) 705-3163-640 A9R59		1
	46	RN50C2672F	2 RESISTOR,FXD, FILM, 26.7K, 1%, 1/20W (V81349) 705-3163-640 A9R58		1
	47	RN50C2672F	2 RESISTOR,FXD, FILM, 26.7K, 1%, 1/20W (V81349) 705-3163-640 A9R61		1
	48	RN50C2672F	2 RESISTOR,FXD, FILM, 26.7K, 1%, 1/20W (V81349) 705-3163-640 A9R62		1
	49	8123A1B8C0G471F	2 CAPACITOR,FXD, CER DIEI, 0.00047UF, 1%, 50V (V72982) 913-3117-210 A9C18		1
	50	CK058X103M	2 CAPACITOR,FXD, CER DIEI, 0.01UF, 20%, 100V (V81349) 913-5019-660 A9C20		1
	51	151D115X9020W2	2 CAPACITOR,FXD, ELCTLT, 1.1UF, 10%, 20V (V56289) 184-A363-000 A9C102		1
	52	T055-301000-1F	2 RESISTOR,FXD, FILM, 301K, 1%, 1/8W (V11502) 705-1471-240 A9R21		1
	53	T055-301000-1F	2 RESISTOR,FXD, FILM, 301K, 1%, 1/8W (V11502) 705-1471-240 A9R22		1
	54	8123-000C0G0331J	2 CAPACITOR,FXD, CER DIEI, 0.00033UF, 5%, 100V (V72982) 913-3117-070 A9C32		1
	55	DM5E300J050WV	2 CAPACITOR,FXD, MICA DIEI, 30PF, 5%, 50V (V72136) 912-4141-200 A9C16		1
	56	CK058X104K	2 CAPACITOR,FXD, CER DIEI, 0.1UF, 10%, 50V (V81349) 913-5019-320 A9C101		1
	57	RN50C3161F	2 RESISTOR,FXD, FILM, 3160 OHMS, 1%, 1/2W (V81349) 705-3162-870 A9R19		1
	58	RN50C3161F	2 RESISTOR,FXD, FILM, 3160 OHMS, 1%, 1/2W (V81349) 705-3162-870 A9R20		1
	59	LP9A1B103F	2 CAPACITOR,FXD, PLSTC DIEI, 0.01UF, 1%, 100V (V01884) 933-1088-020 A9C14		1
	60	C3272G	2 RESISTOR,FXD, FILM, 2.7K, 2%, 1/8W (V24546) 705-3161-590 A9R100		1

GROUP ASSEMBLY PARTS LIST

FIG - ITEM	PART NO	INDENT	DESCRIPTION	USABLE ON CODE	UNITS PER ASSY
11 61	C3153G	2	RESISTOR,FXD, FILM, 15K, 2%, 1/8W (V24546) 705-3161-770 A9R11		1
62	1N4649	2	SEMICONV DEVICE, (V07688) 353-3672-010 A9VR13		1
63	1N746A	2	SEMICONV DEVICE, (V81350) 353-2973-000 A9VR12		1
64	RN50C1102F	2	RESISTOR,FXD, FILM, 11K, 1%, 1/20W (V81349) 705-3163-140 A9R2		1
65	RN50C1102F	2	RESISTOR,FXD, FILM, 11K, 1%, 1/20W (V81349) 705-3163-140 A9R1		1
66	CK05BX104K	2	CAPACITOR,FXD, CER DIEI, 0.1UF, 10%, 50V (V81349) 913-5019-320 A9C100		1
67	RN50C1003F	2	RESISTOR,FXD, FILM, 100K, 1%, 1/20W (V81349) 705-3163-600 A9R18		1
68	RN50C1003F	2	RESISTOR,FXD, FILM, 100K, 1%, 1/20W (V81349) 705-3163-600 A9R17		1
69	RN50C1181F	2	RESISTOR,FXD, FILM, 1.18K, 1%, 1/20W (V81349) 705-3163-610 A9R4		1
70	RN50C1181F	2	RESISTOR,FXD, FILM, 1.18K, 1%, 1/20W (V81349) 705-3163-610 A9R3		1
71	CK05BX104K	2	CAPACITOR,FXD, CER DIEI, 0.1UF, 10%, 50V (V81349) 913-5019-320 A9C2		1
72	RN50C3162F	2	RESISTOR,FXD, FILM, 31.6K, 1%, 1/20W (V81349) 705-3163-360 A9R5		1
73	CK05BX104K	2	CAPACITOR,FXD, CER DIEI, 0.1UF, 10%, 50V (V81349) 913-5019-320 A9C1		1
74	RN50C3162F	2	RESISTOR,FXD, FILM, 31.6K, 1%, 1/20W (V81349) 705-3163-360 A9R6		1
75	CK05BX104K	2	CAPACITOR,FXD, CER DIEI, 0.1UF, 10%, 50V (V81349) 913-5019-320 A9C13		1
76	RN50C2261F	2	RESISTOR,FXD, FILM, 2260 OHMS, 1%, 1/2W (V81349) 705-3162-800 A9R7		1
77	CK05BX104K	2	CAPACITOR,FXD, CER DIEI, 0.1UF, 10%, 50V (V81349) 913-5019-320 A9C12		1
78	SG341	2	INTEGRATED CKT, (V93332) 351-7533-020 A9U401		1
79	CF81	2	INTEGRATED CKT, (V04713) 351-7484-010 A9U301		1
80	CK05BX104M	2	CAPACITOR,FXD, CER DIEI, 0.1UF, 20%, 50V (V81349) 913-5019-720 A9C35		1
81	RCR07G392JS	2	RESISTOR,FXD, CMPSN, 3.9K, 5%, 1/4W (V81349) 745-0769-000 A9R56		1
82	SG71	2	INTEGRATED CKT, (V93332) 351-7264-020 A9U201		1
83	SG341	2	INTEGRATED CKT, (V93332) 351-7533-020 A9U101		1
84	CK05BX104M	2	CAPACITOR,FXD, CER DIEI, 0.1UF, 20%, 50V (V81349) 913-5019-720 A9C33		1
85	SF51	2	INTEGRATED CKT, (V93332) 351-7107-020 A9U104		1
86	RF101K	2	INTEGRATED CKT, (V49956) 351-7297-020 A9U204		1
87	RF101K	2	INTEGRATED CKT, (V49956) 351-7297-020 A9U304		1
88	RG81K	2	INTEGRATED CKT, (V49956) 351-7307-020 A9U404		1
89	C3752G	2	RESISTOR,FXD, FILM, 7.5K, 2%, 1/8W (V24546) 705-3161-700 A9R16		1
90	CK05BX104M	2	CAPACITOR,FXD, CER DIEI, 0.1UF, 20%, 50V (V81349) 913-5019-720 A9C8		1
91	CK05BX104M	2	CAPACITOR,FXD, CER DIEI, 0.1UF, 20%, 50V (V81349) 913-5019-720 A9C9		1
92	1N4150	2	SEMICONV DEVICE, (V81350) 353-9008-100 A9CR6		1
93	1N4150	2	SEMICONV DEVICE, (V81350) 353-9008-100 A9CR3		1
94	RCR05G332K	2	RESISTOR,FXD, CMPSN, 3.3K, 10%, 1/8W (V81349) 745-2359-000 A9R23		1
95	1N4656	2	SEMICONV DEVICE, (V07688) 353-3672-080 A9VR3		1
96	RW70U2740F	2	RESISTOR,FXD,WW, 274 OHMS, 1%, 1W (V81349) 748-2088-240 A9R15		1
97	C3102G	2	RESISTOR,FXD, FILM, 1K, 2%, 1/8W (V24546) 705-3161-490 A9R34		1
98	1N963B	2	SEMICONV DEVICE, (V81350) 353-3085-000 A9VR7		1

## GROUP ASSEMBLY PARTS LIST

FIG - ITEM	PART NO	INDENT	DESCRIPTION	USABLE ON CODE	UNITS PER ASSY
11 99	M39003-01-2116	2	CAPACITOR,FXD, ELCTLT, 1UF, 10%, 50V (V81349) 1A4-9084-430 A9C11		1
100	C3102G	2	RESISTOR,FXD, FILM, 1K, 2%, 1/8W (V24546) 705-3161-490 A9R64		1
101	RCR05G270K	2	RESISTOR,FXD, CMPSN, 27 OHMS, 10%, 1/8W (V81349) 745-2283-000 A9R63		1
102	C3102G	2	RESISTOR,FXD, FILM, 1K, 2%, 1/8W (V24546) 705-3161-490 A9R14		1
103	2N3486A	2	TRANSISTOR, (V81350) 352-7500-780 A9Q7		1
104	RL07S392J	2	RESISTOR,FXD, FILM, 3.9K, 5%, 1/4W (V81349) 745-4276-000 A9R13		1
105	CK05RX103M	2	CAPACITOR,FXD, CER DIEL, 0.01UF, 20%, 100V (V81349) 913-5019-660 A9C28		1
106	2N4855	2	TRANSISTOR, (V07688) 352-0973-010 A9Q6		1
107	CK05BX103M	2	CAPACITOR,FXD, CER DIEL, 0.01UF, 20%, 100V (V81349) 913-5019-660 A9C30		1
108	D45C050D050WV	2	CAPACITOR,FXD, MICA DIEL, 5PF, 0.5PF, 50V (V72136) 912-4141-010 A9C29		1
109	LM101AF	2	INTEGRATED CKT, (V27014) 351-1040-010 A9U904		1
110	RCR05G103K	2	RESISTOR,FXD, CMPSN, 10K, 10%, 1/8W (V81349) 745-2377-000 A9R52		1
111	8123-000C0G0151J	2	CAPACITOR,FXD, CER DIEL, 0.00015UF, 5%, 100V (V72982) 913-3117-050 A9C27		1
112	2N4855	2	TRANSISTOR, (V07688) 352-0973-010 A9Q5		1
113	RN50C1502F	2	RESISTOR,FXD, FILM, 15K, 1%, 1/20W (V81349) 705-3163-630 A9R51		1
114	RN50C4991F	2	RESISTOR,FXD, FILM, 4.99K, 1%, 1/20W (V81349) 705-3163-620 A9R49		1
115	RN50C1002F	2	RESISTOR,FXD, FILM, 10K, 1%, 1/20W (V81349) 705-3163-120 A9R47		1
116	C3152G	2	RESISTOR,FXD, FILM, 1.5K, 2%, 1/8W (V24546) 705-3161-530 A9R43		1
117	C3152G	2	RESISTOR,FXD, FILM, 1.5K, 2%, 1/8W (V24546) 705-3161-530 A9R42		1
118	RN50C1002F	2	RESISTOR,FXD, FILM, 10K, 1%, 1/20W (V81349) 705-3163-120 A9R46		1
119	RN50C4991F	2	RESISTOR,FXD, FILM, 4.99K, 1%, 1/20W (V81349) 705-3163-620 A9R50		1
120	RN50C4991F	2	RESISTOR,FXD, FILM, 4.99K, 1%, 1/20W (V81349) 705-3163-620 A9R48		1
121	2N5066	2	TRANSISTOR, (V07688) 352-0909-010 A9Q4		1
122	2N5066	2	TRANSISTOR, (V07688) 352-0909-010 A9Q3		1
123	C3133G	2	RESISTOR,FXD, FILM, 13K, 2%, 1/8W (V24546) 705-3161-760 A9R44		1
124	C3133G	2	RESISTOR,FXD, FILM, 13K, 2%, 1/8W (V24546) 705-3161-760 A9R45		1
125	LM101AF	2	INTEGRATED CKT, (V27014) 351-1040-010 A9U903		1
126	CK05BX103M	2	CAPACITOR,FXD, CER DIEL, 0.01UF, 20%, 100V (V81349) 913-5019-660 A9C24		1
127	8123-000C0G0151J	2	CAPACITOR,FXD, CER DIEL, 0.00015UF, 5%, 100V (V72982) 913-3117-050 A9C22		1
128	RN50C5361F	2	RESISTOR,FXD, FILM, 5360 OHMS, 1%, 1/2W (V81349) 705-3162-980 A9R28		1
129	CK05BX104M	2	CAPACITOR,FXD, CER DIEL, 0.1UF, 20%, 50V (V81349) 913-5019-720 A9C10		1
130	U3F7710312	2	INTEGRATED CKT, (V07263) 351-7189-040 A9U803		1
131	C3471G	2	RESISTOR,FXD, FILM, 470 OHMS, 2%, 1/8W (V24546) 705-3161-410 A9R37		1
132	C3471G	2	RESISTOR,FXD, FILM, 470 OHMS, 2%, 1/8W (V24546) 705-3161-410 A9R36		1
133	RCR05G332K	2	RESISTOR,FXD, CMPSN, 3.3K, 10%, 1/8W (V81349) 745-2359-000 A9R35		1
134	1N750A	2	SEMICOND DEVICE, (V81350) 353-2977-000 A9VR10		1

GROUP ASSEMBLY PARTS LIST

FIG - ITEM	PART NO	INDENT	DESCRIPTION	USABLE ON CODE	UNITS PER ASSY
11 135	C3560G	2	RESISTOR,FXD, FILM, 56 OHMS, 2%, 1/8W (V24546) 705-3161-190 A9R53		1
136	1N750A	2	SEMICOND DEVICE, (V81350) 353-2977-000 A9VR11		1
137	677-0390-010	2	TRANSFORMER,AF, 677-0390-010 A9T1		1
138	LM101F	2	INTEGRATED CKT, (V27014) 351-1031-010 A9U603		1
139	LM103H3-9	2	INTEGRATED CKT, (V27014) 351-1075-060 A9VR1		1
140	7717-130DAP	2	INSULATOR,DISK, (V13103) 352-9552-580		5
141	M39003-01-2043	2	CAPACITOR,FXD, ELCTLT, 2.2UF, 10%, 20V (V81349) 184-9083-430 A9C7		1
142	C3752G	2	RESISTOR,FXD, FILM, 7.5K, 2%, 1/8W (V24546) 705-3161-700 A9R25		1
143	RCR05G332K	2	RESISTOR,FXD, CMPSN, 3.3K, 10%, 1/8W (V81349) 745-2359-000 A9R24		1
144	C3183G	2	RESISTOR,FXD, FILM, 18K, 2%, 1/8W (V24546) 705-3161-790 A9R41		1
145	RG141K	2	INTEGRATED CKT, (V49956) 351-7093-020 A9U403		1
146	RG191K	2	INTEGRATED CKT, (V49956) 351-7101-020 A9U303		1
147	CK05BX104M	2	CAPACITOR,FXD, CER DIEL, 0.1UF, 20%, 50V (V81349) 913-5019-720 A9C34		1
148	RF101K	2	INTEGRATED CKT, (V49956) 351-7297-020 A9U203		1
149	U3L931251	2	INTEGRATED CKT, (V07263) 351-7430-010 A9U103		1
150	793-9445-001 M551923-314	2	HANDLE 2 PIN,SPRING, SST, 0.078 DIA X 1/4 (V96906) 311-0465-000 (AP)		1
151	372-2601-037	2	CONTACT,ELEC, 372-2601-037		4
152	372-2234-010	2	CONTACT,ELEC, (V13499) 372-2234-010		26
153	372-2234-020	2	CONTACT,ELEC, (V13499) 372-2234-020		23
154	372-2623-033	2	HOUSING,CONN,EL, 372-2623-033		1
155	372-2621-011	2	HOUSING,CONN, 372-2621-011		1
12 -	783-9480-001	1	CIRCUIT CARD ASSY, TCU A9 (SEE FIG 1-15 FOR NHA) M AF		RF
1	1N914	2	SEMICOND DEVICE, (V07688) 353-2906-000 A9CR3		1
2	1N914	2	SEMICOND DEVICE, (V07688) 353-2906-000 A9CR2		1
3	T055-42-2K1F	2	RESISTOR,FXD, FILM, 42.2K, 1%, 1/8W (V11502) 705-1454-780 A9R5		1
4	CM06FD472J03	2	CAPACITOR,FXD, MICA DIEL, 4700PF, 5%, 50nV (V81349) 912-3052-000 A9C1		1
5	MC7404P	2	INTEGRATED CKT, (V04713) 351-7630-010 A9U103		1
6	SN7473N	2	INTEGRATED CKT, (V01295) 351-7640-010 A9U112		1
7	SN74H103N	2	INTEGRATED CKT, (V01295) 351-7745-020 A9U102		1
8	MC7400P	2	INTEGRATED CKT, (V04713) 351-7629-010 A9U93		1
9	SN7474N	2	INTEGRATED CKT, (V01295) 351-7739-010 A9U92		1
10	SN7427N	2	INTEGRATED CKT, (V01295) 351-7722-010 A9U83		1
11	SN74197N	2	INTEGRATED CKT, (V01295) 351-7566-020 A9U82		1
12	S82668	2	INTEGRATED CKT, (V18324) 351-7554-020 A9U72		1
13	MC7400P	2	INTEGRATED CKT, (V04713) 351-7629-010 A9U63		1
14	SN7473N	2	INTEGRATED CKT, (V01295) 351-7640-010 A9U53		1
15	MC7410P	2	INTEGRATED CKT, (V04713) 351-7635-010 A9U43		1
16	8121-050-851-104 Z	2	CAPACITOR,FXD, CER DIEL, 0.1UF, M20XP80%, 50V (V72982) 913-3279-500 A9C7		1
17	SN7474N	2	INTEGRATED CKT, (V01295) 351-7739-010 A9U33		1
18	RCR07G472KS	2	RESISTOR,FXD, CMPSN, 4.7K, 10%, 1/4W (V81349) 745-0773-000 A9R12		1
19	MC836P	2	INTEGRATED CKT, (V04713) 351-7613-010 A9U23		1

GROUP ASSEMBLY PARTS LIST

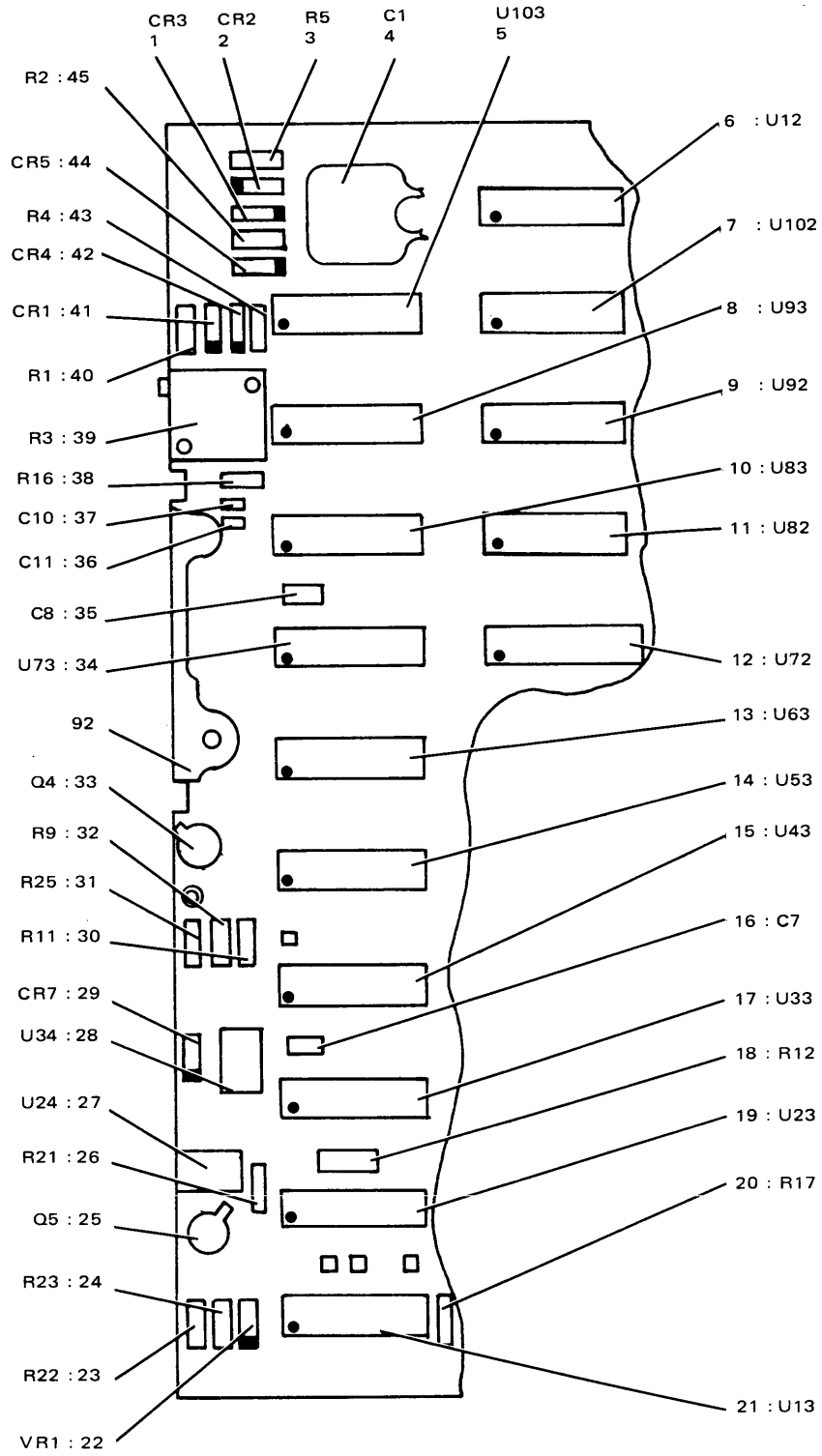

TP3-1047-029

TCU Circuit Card Assembly (A9) 783-9480-001  
Figure 12 (Sheet 1 of 2)

GROUP ASSEMBLY PARTS LIST

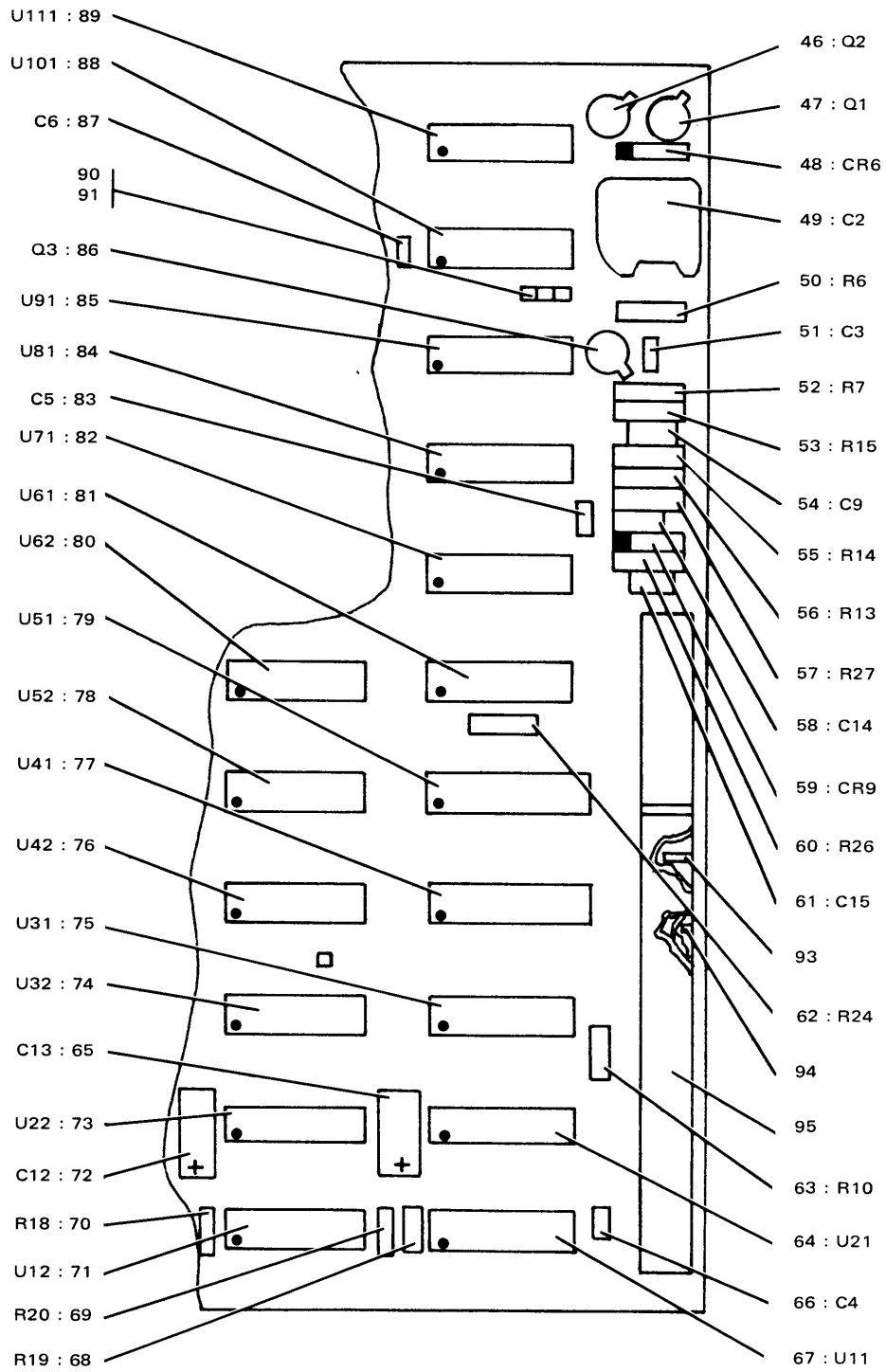

TP3-1047-029

TCU Circuit Card Assembly (A9) 783-9480-001  
Figure 12 (Sheet 2 of 2)



## GROUP ASSEMBLY PARTS LIST

FIG - ITEM	PART NO	INDENT	DESCRIPTION	USABLE ON CODE	UNITS PER ASSY
12	20	RCR07G183KS	2 RESISTOR,FXD, CMPSN, 18K, 10%, 1/4W (V81349) 745-0794-000 A9R17		1
	21	MC7410P	2 INTEGRATED CKT, (V04713) 351-7635-010 A9U13		1
	22	1N971B	2 SEMICOND DEVICE, (V07688) 353-3182-000 A9CR8 (EFF TO CI 73016)		1
	22	1N971B	2 SEMICOND DEVICE, (V07688) 353-3182-000 A9VR1 (EFF CI 73016)		1
	23	RCR07G472KS	2 RESISTOR,FXD, CMPSN, 4.7K, 10%, 1/4W (V81349) 745-0773-000 A9R22		1
	24	RCR07G101KS	2 RESISTOR,FXD, CMPSN, 100 OHMS, 10%, 1/4W (V81349) 745-0713-000 A9R23		1
	25	2N2222A	2 TRANSISTOR, (V07688) 352-0661-020 A9Q5		1
	26	RCR07G151KS	2 RESISTOR,FXD, CMPSN, 150 OHMS, 10%, 1/4W (V81349) 745-0719-000 A9R21		1
	27	MCT2	2 TRANSISTOR, (V29083) 351-0045-010 A9U24		1
	28	MCT2	2 TRANSISTOR, (V29083) 351-0045-010 A9U34		1
	29	1N645	2 SEMICOND DEVICE, (V07688) 353-2607-000 A9CR7		1
	30	RCR07G102KS	2 RESISTOR,FXD, CMPSN, 1K, 10%, 1/4W (V81349) 745-0749-000 A9R11		1
	31	RCR07G122KS	2 RESISTOR,FXD, CMPSN, 1.2K, 10%, 1/4W (V81349) 745-0752-000 A9R25		1
	32	RCR07G153KS	2 RESISTOR,FXD, CMPSN, 15K, 10%, 1/4W (V81349) 745-0791-000 A9R9		1
	33	2N2222A	2 TRANSISTOR, (V07688) 352-0661-020 A9Q4		1
	34	SN7473N	2 INTEGRATED CKT, (V01295) 351-7640-010 A9U73		1
	35	8121-050-651-104 Z	2 CAPACITOR,FXD, CER DIEL, 0.1UF, M20XP80X, 50V (V72982) 913-3279-500 A9C8		1
	36	8101-050-651-471 M	2 CAPACITOR,FXD, CER DIEL, 470PF, 20%, 50V (V72982) 913-3279-010 A9C11		1
	37	8111-050-651-472 M	2 CAPACITOR,FXD, CER DIEL, 4700PF, 20%, 50V (V72982) 913-3279-090 A9C10		1
	38	RCR07G221KS	2 RESISTOR,FXD, CMPSN, 220 OHMS, 10%, 1/4W (V81349) 745-0725-000 A9R16		1
	39	RT22C2P103	2 RESISTOR,VAR, 10K, 5%, 3/4W (V81349) 381-1721-130 A9R3		1
	40	T055-3-83K1F	2 RESISTOR,FXD, FILM, 3.83K, 1%, 1/8W (V11502) 705-1454-530 A9R1		1
	41	1N914	2 SEMICOND DEVICE, (V07688) 353-2906-000 A9CR1		1
	42	1N914	2 SEMICOND DEVICE, (V07688) 353-2906-000 A9CR4		1
	43	T055-332000-1F	2 RESISTOR,FXD, FILM, 33.2K, 1%, 1/8W (V11502) 705-1471-030 A9R4		1
	44	1N914	2 SEMICOND DEVICE, (V07688) 353-2906-000 A9CR5		1
	45	T055-3-83K1F	2 RESISTOR,FXD, FILM, 3.83K, 1%, 1/8W (V11502) 705-1454-530 A9R2		1
	46	2N2222A	2 TRANSISTOR, (V07688) 352-0661-020 A9Q2		1
	47	2N2222A	2 TRANSISTOR, (V07688) 352-0661-020 A9Q1		1
	48	1N914	2 SEMICOND DEVICE, (V07688) 353-2906-000 A9CR6		1
	49	CM06FD472J03	2 CAPACITOR,FXD, MICA DIEL, 4700PF, 5%, 500V (V81349) 912-3052-000 A9C2		1
	50	RCR07G103KS	2 RESISTOR,FXD, CMPSN, 10K, 10%, 1/4W (V81349) 745-0785-000 A9R6		1
	51	8101-050-651-471 M	2 CAPACITOR,FXD, CER DIEL, 470PF, 20%, 50V (V72982) 913-3279-010 A9C3		1
	52	RCR07G222KS	2 RESISTOR,FXD, CMPSN, 2.2K, 10%, 1/4W (V81349) 745-0761-000 A9R7		1
	53	RCR07G221KS	2 RESISTOR,FXD, CMPSN, 220 OHMS, 10%, 1/4W (V81349) 745-0725-000 A9R15		1
	54	8111-050-651-472 M	2 CAPACITOR,FXD, CER DIEL, 4700PF, 20%, 50V (V72982) 913-3279-090 A9C9		1
	55	RCR07G472KS	2 RESISTOR,FXD, CMPSN, 4.7K, 10%, 1/4W (V81349) 745-0773-000 A9R14		1
	56	RCR07G103KS	2 RESISTOR,FXD, CMPSN, 10K, 10%, 1/4W (V81349) 745-0785-000 A9R13		1

GROUP ASSEMBLY PARTS LIST

FIG - ITEM	PART NO	INDENT	DESCRIPTION	USABLE ON CODE	UNITS PER ASSY
12 57	RCR07G221KS	2	RESISTOR,FXD, CMPSN, 220 OHMS, 10%, 1/4W (V81349) 745-0725-000 A9R27		1
58	8111-050-651-472 M	2	CAPACITOR,FXD, CER DIEL, 4700PF, 20%, 50V (V72982) 913-3279-090 A9C14		1
59	1N914	2	SEMICONV DEVICE, (V07688) 353-2906-000 A9CR9		1
60	RCR07G221KS	2	RESISTOR,FXD, CMPSN, 220 OHMS, 10%, 1/4W (V81349) 745-0725-000 A9R26		1
61	8131-050-651-474 M	2	CAPACITOR,FXD, CER DIEL, 0.47UF, 20%, 50V (V72982) 913-3279-250 A9C15		1
62	RCR07G472KS	2	RESISTOR,FXD, CMPSN, 4.7K, 10%, 1/4W (V81349) 745-0773-000 A9R24		1
63	RCR07G102KS	2	RESISTOR,FXD, CMPSN, 1K, 10%, 1/4W (V81349) 745-0749-000 A9R10		1
64	MC7402P	2	INTEGRATED CKT, (V04713) 351-7628-010 A9U21		1
65	109D187X0010F2	2	CAPACITOR,FXD, ELCTLT, 180UF, 20%, 10V (V56289) 184-7784-000 A9C13		1
66	8121-050-651-104 Z	2	CAPACITOR,FXD, CER DIEL, 0.1UF, M20XP80%, 50V (V72982) 913-3279-500 A9C4		1
67	SN7408N	2	INTEGRATED CKT, (V01295) 351-7634-010 A9U11		1
68	RCR07G183KS	2	RESISTOR,FXD, CMPSN, 18K, 10%, 1/4W (V81349) 745-0794-000 A9R19		1
69	RCR07G470KS	2	RESISTOR,FXD, CMPSN, 47 OHMS, 10%, 1/4W (V81349) 745-0701-000 A9R20		1
70	RCR07G470KS	2	RESISTOR,FXD, CMPSN, 47 OHMS, 10%, 1/4W (V81349) 745-0701-000 A9R18		1
71	SG8303	2	INTEGRATED CKT, (V93332) 351-7310-040 A9U12		1
72	M39003-01-2032	2	CAPACITOR,FXD, ELCTLT, 22UF, 20%, 15V (V81349) 184-9083-320 A9C12		1
73	MC7400P	2	INTEGRATED CKT, (V04713) 351-7629-010 A9U22		1
74	MC7400P	2	INTEGRATED CKT, (V04713) 351-7629-010 A9U32		1
75	DM7486N	2	INTEGRATED CKT, (V27014) 351-7663-010 A9U31		1
76	MC7402P	2	INTEGRATED CKT, (V04713) 351-7628-010 A9U42		1
77	SN74151N	2	INTEGRATED CKT, (V01295) 351-7742-010 A9U41		1
78	MC7404P	2	INTEGRATED CKT, (V04713) 351-7630-010 A9U52		1
79	S8266B	2	INTEGRATED CKT, (V18324) 351-7554-020 A9U51		1
80	MC7402P	2	INTEGRATED CKT, (V04713) 351-7628-010 A9U62		1
81	SN74164N	2	INTEGRATED CKT, (V01295) 351-7741-010 A9U61		1
82	S8415A	2	INTEGRATED CKT, (V18324) 351-7466-030 A9U71		1
83	8121-050-651-104 Z	2	CAPACITOR,FXD, CER DIEL, 0.1UF, M20XP80%, 50V (V72982) 913-3279-500 A9C5		1
84	MC7402P	2	INTEGRATED CKT, (V04713) 351-7628-010 A9U81		1
85	MC7400P	2	INTEGRATED CKT, (V04713) 351-7629-010 A9U91		1
86	2N2222A	2	TRANSISTOR, (V07688) 352-0661-020 A9Q3		1
87	8121-050-651-104 Z	2	CAPACITOR,FXD, CER DIEL, 0.1UF, M20XP80%, 50V (V72982) 913-3279-500 A9C6		1
88	MC7493P	2	INTEGRATED CKT, (V04713) 351-7643-010 A9U101		1
89	MC7402P	2	INTEGRATED CKT, (V04713) 351-7628-010 A9U111		1
90	B5171-150-2G	2	CLIP,ELEC, (V29593) 367-1508-010		1
91	372-2601-037	2	CONTACT,ELEC, 372-2601-037		9
92	783-9479-001 MS16562-199	2	HANDLE PIN,SPR, SST, 0.078 DIA X 1/4 (V96906) 311-0355-000 (AP)		1
93	372-2234-010	2	CONTACT,ELEC, (V13499) 372-2234-010		24
94	372-2234-020	2	CONTACT,ELEC, (V13499) 372-2234-020		23
95	372-2623-033	2	HOUSING,CONN,EL, 372-2623-033		1

GROUP ASSEMBLY PARTS LIST

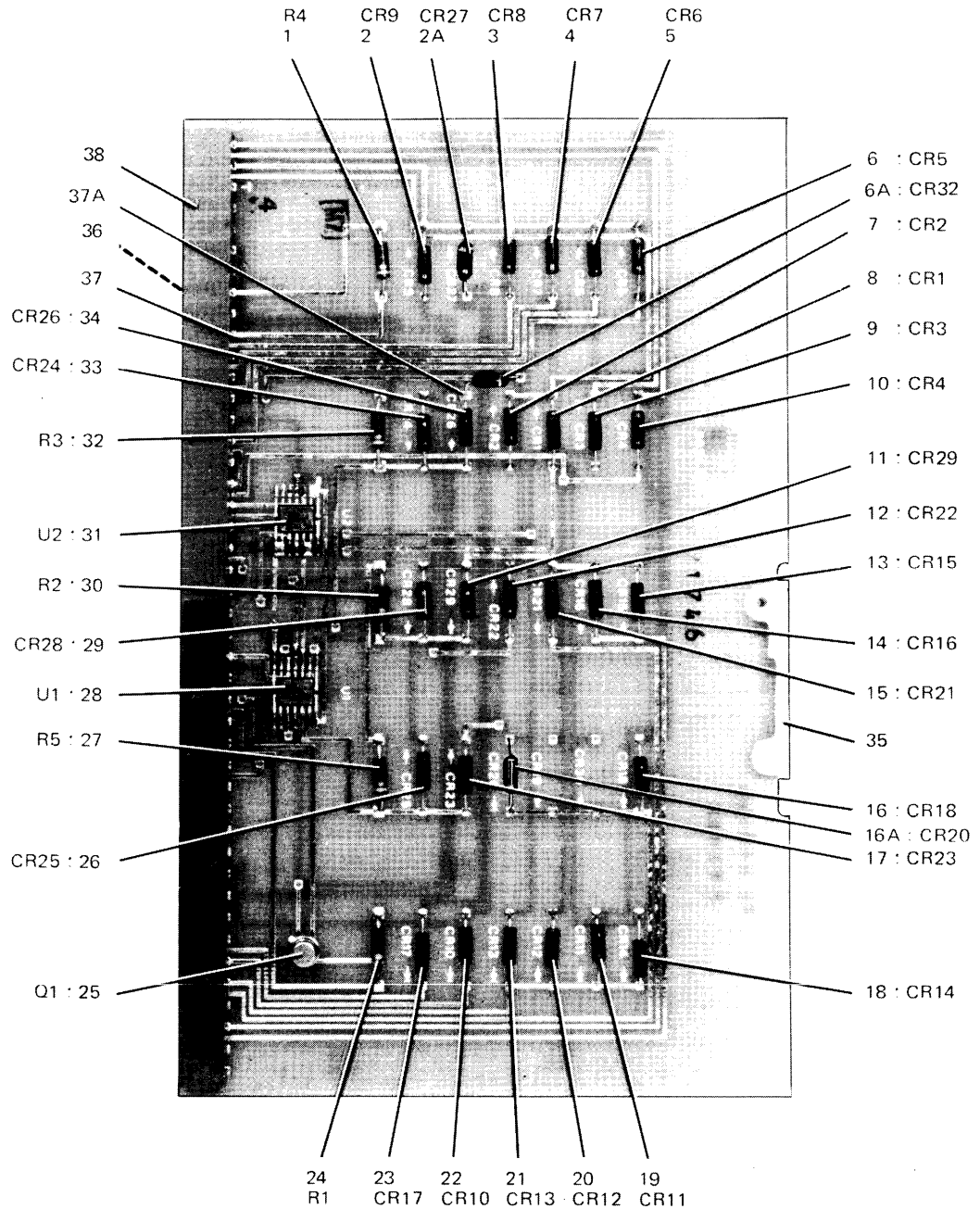

TP3-1046-017

*Interconnect Circuit Card Assembly (A8) 778-2924-004, -006, -007  
Figure 13*

GROUP ASSEMBLY PARTS LIST

FIG - ITEM	PART NO	INDENT	DESCRIPTION	USABLE ON CODE	UNITS PER ASSY
13 -	778-2924-004	1	CIRCUIT CARD ASSY, INTERCONNECT A8 (SEE FIG 1-16 FOR NHA)	AK	RF
-	778-2924-006	1	CIRCUIT CARD ASSY, INTERCONNECT A8 (SEE FIG 1-16 FOR NHA)	AL	RF
-	778-2924-007	1	CIRCUIT CARD ASSY, INTERCONNECT A8 (SEE FIG 1-16 FOR NHA)	CJ	RF
1	RCR07G822KS	2	RESISTOR, FXD, CMPSN, 8.2K, 10%, 1/4W (V81349) 745-0782-000 A8R4		1
2	1N459	2	SEMICONV DEVICE, (V07688) 353-0206-000 A8CR9		1
2A	1N459	2	SEMICONV DEVICE, (V07688) 353-0206-000 A8CR27	AL	1
3	1N459	2	SEMICONV DEVICE, (V07688) 353-0206-000 A8CR8		1
4	1N459	2	SEMICONV DEVICE, (V07688) 353-0206-000 A8CR7		1
5	1N459	2	SEMICONV DEVICE, (V07688) 353-0206-000 A8CR6		1
6	1N459	2	SEMICONV DEVICE, (V07688) 353-0206-000 A8CR5		1
6A	1N459	2	SEMICONV DEVICE, (V07688) 353-0206-000 A8CR32 (EFF CI 72165)		1
7	1N459	2	SEMICONV DEVICE, (V07688) 353-0206-000 A8CR2	AK, CJ	1
8	1N459	2	SEMICONV DEVICE, (V07688) 353-0206-000 A8CR1		1
9	1N459	2	SEMICONV DEVICE, (V07688) 353-0206-000 A8CR3		1
10	1N459	2	SEMICONV DEVICE, (V07688) 353-0206-000 A8CR4		1
11	1N459	2	SEMICONV DEVICE, (V07688) 353-0206-000 A8CR29		1
12	1N459	2	SEMICONV DEVICE, (V07688) 353-0206-000 A8CR22		1
13	1N459	2	SEMICONV DEVICE, (V07688) 353-0206-000 A8CR15		1
14	1N459	2	SEMICONV DEVICE, (V07688) 353-0206-000 A8CR16		1
15	1N459	2	SEMICONV DEVICE, (V07688) 353-0206-000 A8CR21		1
16	1N459	2	SEMICONV DEVICE, (V07688) 353-0206-000 A8CR18		1
16A	1N459	2	SEMICONV DEVICE, (V07688) 353-0206-000 A8CR20	CJ	1
17	1N459	2	SEMICONV DEVICE, (V07688) 353-0206-000 A8CR23		1
18	1N459	2	SEMICONV DEVICE, (V07688) 353-0206-000 A8CR14		1
19	1N459	2	SEMICONV DEVICE, (V07688) 353-0206-000 A8CR11		1
20	1N459	2	SEMICONV DEVICE, (V07688) 353-0206-000 A8CR12		1
21	1N459	2	SEMICONV DEVICE, (V07688) 353-0206-000 A8CR13	AK, AL	1
22	1N459	2	SEMICONV DEVICE, (V07688) 353-0206-000 A8CR10		1
23	1N459	2	SEMICONV DEVICE, (V07688) 353-0206-000 A8CR17		1
24	RCR07G102KS	2	RESISTOR, FXD, CMPSN, 1K, 10%, 1/4W (V81349) 745-0749-000 A8R1		1
25	2N2222A	2	TRANSISTOR, (V07688) 352-0661-020 A8Q1		1
26	1N459	2	SEMICONV DEVICE, (V07688) 353-0206-000 A8CR25		1
27	RCR07G822KS	2	RESISTOR, FXD, CMPSN, 8.2K, 10%, 1/4W (V81349) 745-0782-000 A8R5		1
28	SG143	2	INTEGRATED CKT, (V93332) 351-7094-020 A811		1
29	1N459	2	SEMICONV DEVICE, (V07688) 353-0206-000 A8CR28		1
30	RCR07G822KS	2	RESISTOR, FXD, CMPSN, 8.2K, 10%, 1/4W (V81349) 745-0782-000 A8R2		1
31	SG143	2	INTEGRATED CKT, (V93332) 351-7094-020 A8112		1
32	RCR07G822KS	2	RESISTOR, FXD, CMPSN, 8.2K, 10%, 1/4W (V81349) 745-0782-000 A8R3		1
33	1N459	2	SEMICONV DEVICE, (V07688) 353-0206-000 A8CR24		1
34	1N459	2	SEMICONV DEVICE, (V07688) 353-0206-000 A8CR26		1
35	790-2666-004	2	HANDLE	AK	1
35	790-2666-006	2	HANDLE	AL	1
35	790-2666-007	2	HANDLE	CJ	1
	M851923-156	2	PIN, SPRING, SST, 0.062 DIA X 3/4 (V96906) 311-0460-000 (AP)		1
36	372-2234-010	2	CONTACT, ELEC, (V13499) 372-2234-010		21
37	372-2234-020	2	CONTACT, ELEC, (V13499) 372-2234-020		32
37A	372-2601-027	2	CONTACT, ELEC, 372-2601-027 (EFF CI 72165)		1
38	372-2623-031	2	HOUSING, CONN, EL, 372-2623-031		2

GROUP ASSEMBLY PARTS LIST

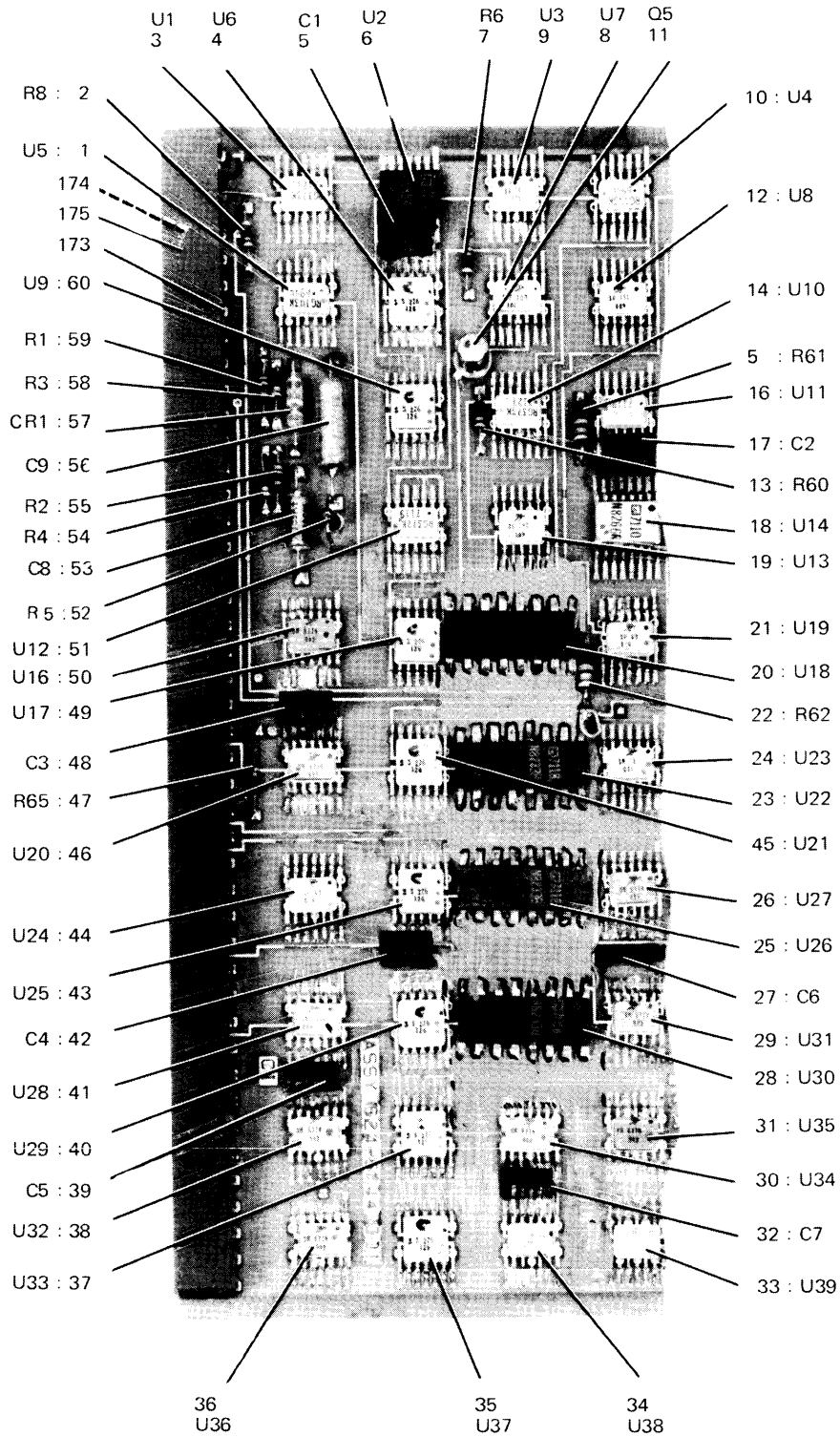

TP3-1045-027

DCFE Circuit Card Assembly (A8) 624-5744-001  
Figure 14 (Sheet 1 of 2)

GROUP ASSEMBLY PARTS LIST

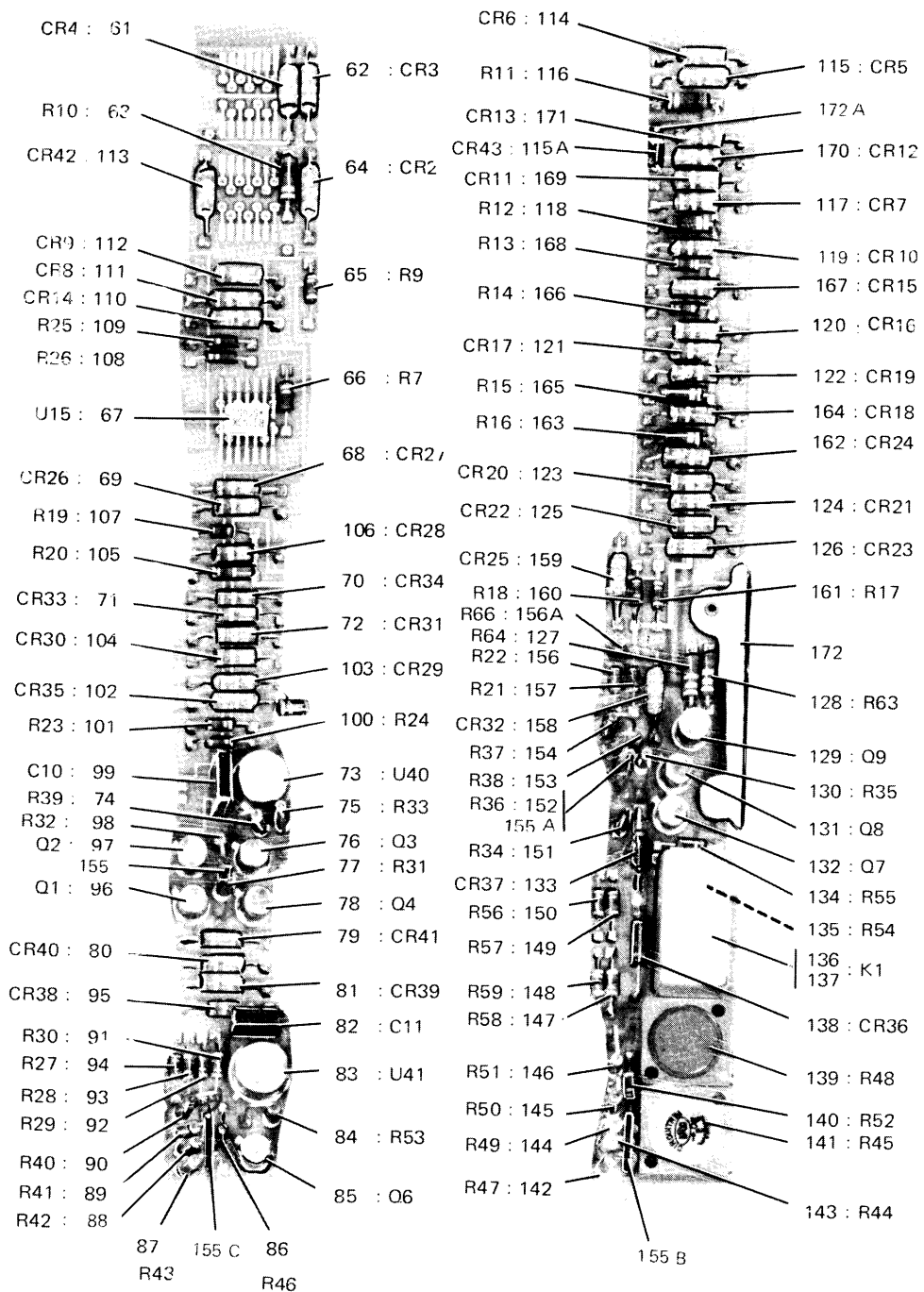

TP3-1045-027

DCFE Circuit Card Assembly (A8) 624-5744-001  
Figure 14 (Sheet 2 of 2)

## GROUP ASSEMBLY PARTS LIST

FIG - ITEM	PART NO	INDENT	DESCRIPTION	USABLE ON CODE	UNITS PER ASSY
14 -	624-5744-001	1	CIRCUIT CARD ASSY, DCFE A8 (SEE FIG 1-16 FOR NHA)	R,E,F,M P,Q,X,Z AB,AD,AF AQ,AS,AW AX	RF 1
1	SG143	2	INTEGRATED CKT, (V93332) 351-7094-020 A8U5		1
2	RCR05G472K	2	RESISTOR,FXD, CMPSN, 4.7K, 10%, 1/8W (V81349) 745-2365-000 A8R8		1
3	RG373K	2	INTEGRATED CKT, (V49956) 351-7494-020 A8U1		1
4	SS226	2	INTEGRATED CKT, (V93332) 351-7333-020 A8U6		1
5	CK068X104M	2	CAPACITOR,FXD, CER DIEL, 0.1UF, 20%, 100V (V81349) 913-5019-780 A8C1		1
6	S8424W	2	INTEGRATED CKT, (V18324) 351-7332-030 A8U2		1
7	RCR05G472K	2	RESISTOR,FXD, CMPSN, 4.7K, 10%, 1/8W (V81349) 745-2365-000 A8R6		1
8	SF103	2	INTEGRATED CKT, (V93332) 351-7318-020 A8U7		1
9	SG143	2	INTEGRATED CKT, (V93332) 351-7094-020 A8U3		1
10	SG143	2	INTEGRATED CKT, (V93332) 351-7094-020 A8U4		1
11	2N2222A	2	TRANSISTOR, (V07688) 352-0661-020 A8Q5		1
12	SG193	2	INTEGRATED CKT, (V93332) 351-7102-020 A8U8		1
13	RCR05G102K	2	RESISTOR,FXD, CMPSN, 1K, 10%, 1/8W (V81349) 745-2341-000 A8R60		1
14	RG373K	2	INTEGRATED CKT, (V49956) 351-7494-020 A8U10		1
15	RCR05G123K	2	RESISTOR,FXD, CMPSN, 12K, 10%, 1/8W (V81349) 745-2380-000 A8R61		1
16	RG372K	2	INTEGRATED CKT, (V49956) 351-7494-010 A8U11		1
17	CK068X104M	2	CAPACITOR,FXD, CER DIEL, 0.1UF, 20%, 100V (V81349) 913-5019-780 A8C2		1
18	N8266R	2	INTEGRATED CKT, (V18324) 351-7519-010 A8U14		1
19	SG193	2	INTEGRATED CKT, (V93332) 351-7102-020 A8U13		1
20	N8233R	2	INTEGRATED CKT, (V18324) 351-7666-020 A8U18		1
21	SM63	2	INTEGRATED CKT, (V93332) 351-7374-040 A8U19		1
22	RCR05G123K	2	RESISTOR,FXD, CMPSN, 12K, 10%, 1/8W (V81349) 745-2380-000 A8R62		1
23	N8233R	2	INTEGRATED CKT, (V18324) 351-7666-020 A8U22		1
24	SM73	2	INTEGRATED CKT, (V93332) 351-7323-020 A8U23		1
25	N8233R	2	INTEGRATED CKT, (V18324) 351-7666-020 A8U26		1
26	SM63	2	INTEGRATED CKT, (V93332) 351-7374-040 A8U27		1
27	CK068X104M	2	CAPACITOR,FXD, CER DIEL, 0.1UF, 20%, 100V (V81349) 913-5019-780 A8C6		1
28	N8233R	2	INTEGRATED CKT, (V18324) 351-7666-020 A8U30		1
29	SM63	2	INTEGRATED CKT, (V93332) 351-7374-040 A8U31		1
30	SM63	2	INTEGRATED CKT, (V93332) 351-7374-040 A8U34		1
31	SM63	2	INTEGRATED CKT, (V93332) 351-7374-040 A8U35		1
32	CK068X104M	2	CAPACITOR,FXD, CER DIEL, 0.1UF, 20%, 100V (V81349) 913-5019-780 A8C7		1
33	SG43	2	INTEGRATED CKT, (V93332) 351-7078-020 A8U39		1
34	SM63	2	INTEGRATED CKT, (V93332) 351-7374-040 A8U38		1
35	SS226	2	INTEGRATED CKT, (V93332) 351-7333-020 A8U37		1
36	SM63	2	INTEGRATED CKT, (V93332) 351-7374-040 A8U36		1
37	SS226	2	INTEGRATED CKT, (V93332) 351-7333-020 A8U33		1
38	SM63	2	INTEGRATED CKT, (V93332) 351-7374-040 A8U32		1
39	CK068X104M	2	CAPACITOR,FXD, CER DIEL, 0.1UF, 20%, 100V (V81349) 913-5019-780 A8C5		1
40	SS226	2	INTEGRATED CKT, (V93332) 351-7333-020 A8U29		1
41	SM63	2	INTEGRATED CKT, (V93332) 351-7374-040 A8U28		1
42	CK068X104M	2	CAPACITOR,FXD, CER DIEL, 0.1UF, 20%, 100V (V81349) 913-5019-780 A8C4		1
43	SS226	2	INTEGRATED CKT, (V93332) 351-7333-020 A8U25		1
44	SM63	2	INTEGRATED CKT, (V93332) 351-7374-040 A8U24		1
45	SS226	2	INTEGRATED CKT, (V93332) 351-7333-020 A8U21		1
46	SM63	2	INTEGRATED CKT, (V93332) 351-7374-040 A8U20		1
47	RCR05G472K	2	RESISTOR,FXD, CMPSN, 4.7K, 10%, 1/8W (V81349) 745-2365-000 A8R65		1

## GROUP ASSEMBLY PARTS LIST

FIG - ITEM	PART NO	INDENT	DESCRIPTION	USABLE ON CODE	UNITS PER ASSY
14 48	CK06BX104M	2	CAPACITOR,FXD, CER DIEL, 0.1UF, 20%, 100V (V81349) 913-5019-780 A8C3		1
49	SS226	2	INTEGRATED CKT, (V93332) 351-7333-020 A8U17		1
50	SM63	2	INTEGRATED CKT, (V93332) 351-7374-040 A8U16		1
51	RG372K	2	INTEGRATED CKT, (V49956) 351-7494-010 A8U12		1
52	RCR07G100KS	2	RESISTOR,FXD, CMPSN, 10 OHMS, 10%, 1/4W (V81349) 745-0677-000 A8R5		1
53	M39003-01-2003	2	CAPACITOR,FXD, ELCTLT, 6.8UF, 20%, 6V (V81349) 1A4-9083-030 A8C8		1
54	RCR05G121K	2	RESISTOR,FXD, CMPSN, 120 OHMS, 10%, 1/8W (V81349) 745-2308-000 A8R4		1
55	RCR05G331K	2	RESISTOR,FXD, CMPSN, 330 OHMS, 10%, 1/8W (V81349) 745-2323-000 A8R2		1
56	M39003-01-2018	2	CAPACITOR,FXD, ELCTLT, 33UF, 20%, 10V (V81349) 1A4-9083-180 A8C9		1
57	1N459	2	SEMICONV DEVICE, (V07688) 353-0206-000 A8CR1		1
58	RCR05G121K	2	RESISTOR,FXD, CMPSN, 120 OHMS, 10%, 1/8W (V81349) 745-2308-000 A8R3		1
59	RCR05G331K	2	RESISTOR,FXD, CMPSN, 330 OHMS, 10%, 1/8W (V81349) 745-2323-000 A8R1		1
60	SS226	2	INTEGRATED CKT, (V93332) 351-7333-020 A8U19		1
61	1N459	2	SEMICONV DEVICE, (V07688) 353-0206-000 A8CR4		1
62	1N459	2	SEMICONV DEVICE, (V07688) 353-0206-000 A8CR3		1
63	RCR05G102K	2	RESISTOR,FXD, CMPSN, 1K, 10%, 1/8W (V81349) 745-2341-000 A8R10		1
64	1N459	2	SEMICONV DEVICE, (V07688) 353-0206-000 A8CR2		1
65	RCR05G472K	2	RESISTOR,FXD, CMPSN, 4.7K, 10%, 1/8W (V81349) 745-2365-000 A8R9 (EFF TO CI 72275)		1
65	RCR05G222K	2	RESISTOR,FXD, CMPSN, 2.2K, 10%, 1/8W (V81349) 745-2353-000 A8R9 (EFF CI 72275)		1
66	RCR05G822K	2	RESISTOR,FXD, CMPSN, 8.2K, 10%, 1/8W (V81349) 745-2374-000 A8R7		1
67	SG143	2	INTEGRATED CKT, (V93332) 351-7094-020 A8U15		1
68	1N459	2	SEMICONV DEVICE, (V07688) 353-0206-000 A8CR27		1
69	1N459	2	SEMICONV DEVICE, (V07688) 353-0206-000 A8CR26		1
70	1N459	2	SEMICONV DEVICE, (V07688) 353-0206-000 A8CR34		1
71	1N459	2	SEMICONV DEVICE, (V07688) 353-0206-000 A8CR33		1
72	1N459	2	SEMICONV DEVICE, (V07688) 353-0206-000 A8CR31		1
73	RC741T	2	INTEGRATED CKT, (V49956) 351-1029-020 A8U40		1
74	T055-10K1F	2	RESISTOR,FXD, FILM, 10K, 1%, 1/8W (V11502) 705-1454-630 A8R39		1
75	T055-8060-1F	2	RESISTOR,FXD, FILM, 8.06K, 1%, 1/8W (V11502) 705-1468-370 A8R33		1
76	2N2222A	2	TRANSISTOR, (V07688) 352-0661-020 A8Q3		1
77	T055-2000-1F	2	RESISTOR,FXD, FILM, 2K, 1%, 1/8W (V11502) 705-1468-080 A8R31		1
78	2N2222A	2	TRANSISTOR, (V07688) 352-0661-020 A8Q4		1
79	1N459	2	SEMICONV DEVICE, (V07688) 353-0206-000 A8CR41		1
80	1N459	2	SEMICONV DEVICE, (V07688) 353-0206-000 A8CR40		1
81	1N459	2	SEMICONV DEVICE, (V07688) 353-0206-000 A8CR39		1
82	CK06BX104M	2	CAPACITOR,FXD, CER DIEL, 0.1UF, 20%, 100V (V81349) 913-5019-780 A8C11		1
83	RC741T	2	INTEGRATED CKT, (V49956) 351-1029-020 A8U41		1
84	T055-10K1F	2	RESISTOR,FXD, FILM, 10K, 1%, 1/8W (V11502) 705-1454-630 A8R53		1
85	2N2222A	2	TRANSISTOR, (V07688) 352-0661-020 A8Q6		1
86	RCR05G102K	2	RESISTOR,FXD, CMPSN, 1K, 10%, 1/8W (V81349) 745-2341-000 A8R46		1
87	T055-16-2K1F	2	RESISTOR,FXD, FILM, 16.2K, 1%, 1/8W (V11502) 705-1454-680 A8R43		1
88	T055-8060-1F	2	RESISTOR,FXD, FILM, 8.06K, 1%, 1/8W (V11502) 705-1468-370 A8R42		1



## GROUP ASSEMBLY PARTS LIST

FIG - ITEM	PART NO	INDENT	DESCRIPTION	USABLE ON CODE	UNITS PER ASSY
14	92	RCR05G472K	2 RESISTOR,FXD, CMPSN, 4.7K, 10%, 1/8W (V81349) 745-2365-000 ABR29		1
	93	RCR05G472K	2 RESISTOR,FXD, CMPSN, 4.7K, 10%, 1/8W (V81349) 745-2365-000 ABR28		1
	94	RCR05G472K	2 RESISTOR,FXD, CMPSN, 4.7K, 10%, 1/8W (V81349) 745-2365-000 ABR27		1
	95	1N459	2 SEMICOND DEVICE, (V07688) 353-0206-000 AACR38		1
	96	2N2222A	2 TRANSISTOR, (V07688) 352-0661-020 A8Q1		1
	97	2N2222A	2 TRANSISTOR, (V07688) 352-0661-020 A8Q2		1
	98	T055-4021-1F	2 RESISTOR,FXD, FILM, 4.02K, 1%, 1/8W (V11502) 705-1470-770 A8R32		1
	99	CK06R4104M	2 CAPACITOR,FXD, GER DIE, 0.1UF, 20%, 100V (V81349) 913-5019-7A0 A8C10		1
	100	RCR05G472K	2 RESISTOR,FXD, CMPSN, 4.7K, 10%, 1/8W (V81349) 745-2365-000 ABR24		1
	101	RCR05G472K	2 RESISTOR,FXD, CMPSN, 4.7K, 10%, 1/8W (V81349) 745-2365-000 ABR23 (EFF TO CI 72256)		1
	101	RCR05G222K	2 RESISTOR,FXD, CMPSN, 2.2K, 10%, 1/8W (V81349) 745-2353-000 ABR23 (EFF CI 72256)		1
	102	1N459	2 SEMICOND DEVICE, (V07688) 353-0206-000 AACR35		1
	103	1N459	2 SEMICOND DEVICE, (V07688) 353-0206-000 AACR29		1
	104	1N459	2 SEMICOND DEVICE, (V07688) 353-0206-000 AACR30		1
	105	RCR05G472K	2 RESISTOR,FXD, CMPSN, 4.7K, 10%, 1/8W (V81349) 745-2365-000 ABR20 (EFF TO CI 72256)		1
	105	RCR05G222K	2 RESISTOR,FXD, CMPSN, 2.2K, 10%, 1/8W (V81349) 745-2353-000 ABR20 (EFF CI 72256)		1
	106	1N459	2 SEMICOND DEVICE, (V07688) 353-0206-000 AACR28		1
	107	RCR05G472K	2 RESISTOR,FXD, CMPSN, 4.7K, 10%, 1/8W (V81349) 745-2365-000 ABR19 (EFF TO CI 72256)		1
	107	RCR05G222K	2 RESISTOR,FXD, CMPSN, 2.2K, 10%, 1/8W (V81349) 745-2353-000 ABR19 (EFF CI 72256)		1
	108	RCR05G822K	2 RESISTOR,FXD, CMPSN, 8.2K, 10%, 1/8W (V81349) 745-2374-000 ABR26		1
	109	RCR05G822K	2 RESISTOR,FXD, CMPSN, 8.2K, 10%, 1/8W (V81349) 745-2374-000 ABR25		1
	110	1N459	2 SEMICOND DEVICE, (V07688) 353-0206-000 AACR14		1
	111	1N459	2 SEMICOND DEVICE, (V07688) 353-0206-000 AACR8		1
	112	1N459	2 SEMICOND DEVICE, (V07688) 353-0206-000 AACR9		1
	113	1N459	2 SEMICOND DEVICE, (V07688) 353-0206-000 AACR42		1
	114	1N459	2 SEMICOND DEVICE, (V07688) 353-0206-000 AACR6		1
	115	1N459	2 SEMICOND DEVICE, (V07688) 353-0206-000 AACR5		1
	115A	1N459	2 SEMICOND DEVICE, (V07688) 353-0206-000 AACR43 (EFF CI 72256)		1
	116	RCR05G102K	2 RESISTOR,FXD, CMPSN, 1K, 10%, 1/8W (V81349) 745-2341-000 ABR11		1
	117	1N459	2 SEMICOND DEVICE, (V07688) 353-0206-000 AACR7		1
	118	RCR05G102K	2 RESISTOR,FXD, CMPSN, 1K, 10%, 1/8W (V81349) 745-2341-000 ABR12		1
	119	1N459	2 SEMICOND DEVICE, (V07688) 353-0206-000 AACR10		1
	120	1N459	2 SEMICOND DEVICE, (V07688) 353-0206-000 AACR16		1
	121	1N459	2 SEMICOND DEVICE, (V07688) 353-0206-000 AACR17		1
	122	1N459	2 SEMICOND DEVICE, (V07688) 353-0206-000 AACR19		1
	123	1N459	2 SEMICOND DEVICE, (V07688) 353-0206-000 AACR20		1
	124	1N459	2 SEMICOND DEVICE, (V07688) 353-0206-000 AACR21		1
	125	1N459	2 SEMICOND DEVICE, (V07688) 353-0206-000 AACR22		1
	126	1N459	2 SEMICOND DEVICE, (V07688) 353-0206-000 AACR23		1
	127	RCR05G123K	2 RESISTOR,FXD, CMPSN, 12K, 10%, 1/8W (V81349) 745-2380-000 ABR64		1
	128	RCR05G123K	2 RESISTOR,FXD, CMPSN, 12K, 10%, 1/8W (V81349) 745-2380-000 ABR63		1
	129	2N2222A 609-2541-001	2 TRANSISTOR, (V07688) 352-0661-020 A8Q9		1
	130	T055-31-6-1F	3 RESISTOR, KIT (NON-PROCURABLE ITEM)		1
	130	T055-34-8-1F	3 RESISTOR,FXD, FILM, 31.6 OHMS, 1%, 1/8W (V11502) 705-1454-030 A8R35		AR
	130	T055-34-8-1F	3 RESISTOR,FXD, FILM, 34.8 OHMS, 1%, 1/8W (V11502) 705-1454-040 A8R35		AR
	130	T055-29R4F	3 RESISTOR,FXD, FILM, 29.4 OHMS, 1%, 1/8W (V11502) 705-1469-210 A8R35		AR

GROUP ASSEMBLY PARTS LIST

FIG - ITEM	PART NO	INDENT	DESCRIPTION	USABLE ON CODE	UNITS PER ASSY
14	130 T055-30R9F	3	RESISTOR, FXD, FILM, 30.9 OHMS, 1%, 1/8W (V11502) 705-1469-220 A8R35		AR
	130 T055-32R4F	3	RESISTOR, FXD, FILM, 32.4 OHMS, 1%, 1/8W (V11502) 705-1469-230 A8R35		AR
	130 T055-34R0F	3	RESISTOR, FXD, FILM, 34 OHMS, 1%, 1/8W (V11502) 705-1469-240 A8R35		AR
	130 T055-35R7F	3	RESISTOR, FXD, FILM, 35.7 OHMS, 1%, 1/8W (V11502) 705-1469-250 A8R35		AR
	130 T055-30R1-1F	3	RESISTOR, FXD, FILM, 30.1 OHMS, 1%, 1/8W (V11502) 705-1470-240 A8R35		AR
	130 T055-33R2-1F	3	RESISTOR, FXD, FILM, 33.2 OHMS, 1%, 1/8W (V11502) 705-1470-250 A8R35		AR
	130 T055-36R5-1F	3	RESISTOR, FXD, FILM, 36.5 OHMS, 1%, 1/8W (V11502) 705-1470-260 A8R35		AR
	131 2N2222A	2	TRANSISTOR, (V07688) 352-0661-020 A8Q8		1
	132 2N2222A	2	TRANSISTOR, (V07688) 352-0661-020 A8Q7		1
	133 1N4001	2	SEMICOND DEVICE, (V04713) 353-6442-010 AACR37		1
	134 RCR05G102K	2	RESISTOR, FXD, CMPSN, 1K, 10%, 1/8W (V81349) 745-2341-000 A8R55		1
	135 RCR05G102K	2	RESISTOR, FXD, CMPSN, 1K, 10%, 1/8W (V81349) 745-2341-000 A8R54		1
	136 3SAV1118A2	2	RELAY, AMT, (V01526) 974-1065-110 A8K1		1
	137 RCRP800060-2A	2	INSULATOR, (V19080) 150-0684-020		1
	138 1N645	2	SEMICOND DEVICE, (V07688) 353-2607-000 AACR36		1
	139 RT22C2P102	2	RESISTOR, VAR, WW, 1K, 5%, 3/4W (V81349) 3A1-1721-040 A8R48		1
	140 RCR05G472K	2	RESISTOR, FXD, CMPSN, 4.7K, 10%, 1/8W (V81349) 745-2365-000 A8R52 (EFF TO CI 73086)		1
	141 RT22C2P101	2	RESISTOR, VAR, WW, 100 OHMS, 5%, 3/4W (V81349) 3A1-1721-010 A8R45		1
	142 T055-10K1F	2	RESISTOR, FXD, FILM, 10K, 1%, 1/8W (V11502) 705-1454-630 A8R47		1
	143 T055-1K1F	2	RESISTOR, FXD, FILM, 1K, 1%, 1/8W (V11502) 705-1454-390 A8R44		1
	144 T055-1K1F	2	RESISTOR, FXD, FILM, 1K, 1%, 1/8W (V11502) 705-1454-390 A8R49		1
	145 55D4990F	2	RESISTOR, FXD, FILM, 499 OHMS, 1%, 1/8W (V96214) 705-1469-790 A8R50		1
	146 T055-10K1F	2	RESISTOR, FXD, FILM, 10K, 1%, 1/8W (V11502) 705-1454-630 A8R51		1
	147 RCR05G472K	2	RESISTOR, FXD, CMPSN, 4.7K, 10%, 1/8W (V81349) 745-2365-000 A8R58		1
	148 RCR05G472K	2	RESISTOR, FXD, CMPSN, 4.7K, 10%, 1/8W (V81349) 745-2365-000 A8R59		1
	149 RCR05G472K	2	RESISTOR, FXD, CMPSN, 4.7K, 10%, 1/8W (V81349) 745-2365-000 A8R57		1
	150 RCR05G472K	2	RESISTOR, FXD, CMPSN, 4.7K, 10%, 1/8W (V81349) 745-2365-000 A8R56		1
	151 T055-16-2K1F	2	RESISTOR, FXD, FILM, 16.2K, 1%, 1/8W (V11502) 705-1454-680 A8R34		1
	152 T055-100-1F	2	RESISTOR, FXD, FILM, 100 OHMS, 1%, 1/8W (V11502) 705-1454-150 A8R36		1
	153 T055-10K1F	2	RESISTOR, FXD, FILM, 10K, 1%, 1/8W (V11502) 705-1454-630 A8R38		1
	785-2797-001	2	RESISTOR KIT, (NON-PROCURABLE ITEM)		1
	154 T055-51-1-1F	3	RESISTOR, FXD, FILM, 51.1 OHMS, 1%, 1/8W (V11502) 705-1454-080 A8R37		AR
	154 T055-56-2-1F	3	RESISTOR, FXD, FILM, 56.2 OHMS, 1%, 1/8W (V11502) 705-1454-090 A8R37		AR
	154 T055-61-9-1F	3	RESISTOR, FXD, FILM, 61.9 OHMS, 1%, 1/8W (V11502) 705-1454-100 A8R37		AR
	154 55D47R5F	3	RESISTOR, FXD, FILM, 47.5 OHMS, 1%, 1/8W (V96214) 705-1469-310 A8R37		AR
	154 55D49R9F	3	RESISTOR, FXD, FILM, 49.9 OHMS, 1%, 1/8W (V96214) 705-1469-320 A8R37		AR
	154 55D52R3F	3	RESISTOR, FXD, FILM, 52.3 OHMS, 1%, 1/8W (V96214) 705-1469-330 A8R37		AR
	154 55D54R9F	3	RESISTOR, FXD, FILM, 54.9 OHMS, 1%, 1/8W (V96214) 705-1469-340 A8R37		AR

## GROUP ASSEMBLY PARTS LIST

FIG - ITEM	PART NO	INDENT	DESCRIPTION	USABLE ON CODE	UNITS PER ASSY
14 154	55D57R6F	3	RESISTOR,FXD, FILM, 57.6 OHMS, 1%, 1/8W (V96214) 705-1469-350 A8R37		AR
154	55D60R4F	3	RESISTOR,FXD, FILM, 60.4 OHMS, 1%, 1/8W (V96214) 705-1469-360 A8R37		AR
154	55D63R4F	3	RESISTOR,FXD, FILM, 63.4 OHMS, 1%, 1/8W (V96214) 705-1469-370 A8R37		AR
154	T055-48R7-1F	3	RESISTOR,FXD, FILM, 48.7 OHMS, 1%, 1/8W (V11502) 705-1470-290 A8R37		AR
154	T055-53R6-1F	3	RESISTOR,FXD, FILM, 53.6 OHMS, 1%, 1/8W (V11502) 705-1470-300 A8R37		AR
154	T055-59R0-1F	3	RESISTOR,FXD, FILM, 59 OHMS, 1%, 1/8W (V11502) 705-1470-310 A8R37		AR
154	T055-64R9-1F	3	RESISTOR,FXD, FILM, 64.9 OHMS, 1%, 1/8W (V11502) 705-1470-320		AR
155	RCCS250437-1A	2	COMPONENT INSUL, (V19080) 150-0792-010		7
155A	RCCS250437-2A	2	COMPONENT INSUL, (V19080) 150-0792-020		3
155B	RCCS250437-3A	2	COMPONENT INSUL, (V19080) 150-0792-030		3
155C	RCCS250437-4A	2	COMPONENT INSUL, (V19080) 150-0792-040		1
156	RCR05G472K	2	RESISTOR,FXD, CMPSN, 4.7K, 10%, 1/8W (V81349) 745-2365-000 A8R22 (EFF TO CI 72256)		1
156	RCR05G222K	2	RESISTOR,FXD, CMPSN, 2.2K, 10%, 1/8W (V81349) 745-2353-000 A8R22 (EFF CI 72256)		1
156A	RCR05G562K	2	RESISTOR,FXD, CMPSN, 5.6K, 10%, 1/8W (V81349) 745-2368-000 A8R66 (EFF CI 72256)		1
157	RCR05G472K	2	RESISTOR,FXD, CMPSN, 4.7K, 10%, 1/8W (V81349) 745-2365-000 A8R21 (EFF TO CI 72256)		1
157	RCR05G222K	2	RESISTOR,FXD, CMPSN, 2.2K, 10%, 1/8W (V81349) 745-2353-000 A8R21 (EFF CI 72256)		1
158	1N459	2	SEMICONV DEVICE, (V07688) 353-0206-000 AACR32		1
159	1N459	2	SEMICONV DEVICE, (V07688) 353-0206-000 AACR25		1
160	RCR05G472K	2	RESISTOR,FXD, CMPSN, 4.7K, 10%, 1/8W (V81349) 745-2365-000 A8R18 (EFF TO CI 72256)		1
160	RCR05G222K	2	RESISTOR,FXD, CMPSN, 2.2K, 10%, 1/8W (V81349) 745-2353-000 A8R18 (EFF CI 72256)		1
161	RCR05G472K	2	RESISTOR,FXD, CMPSN, 4.7K, 10%, 1/8W (V81349) 745-2365-000 A8R17 (EFF TO CI 72256)		1
161	RCR05G222K	2	RESISTOR,FXD, CMPSN, 2.2K, 10%, 1/8W (V81349) 745-2353-000 A8R17 (EFF CI 72256)		1
162	1N459	2	SEMICONV DEVICE, (V07688) 353-0206-000 AACR24		1
163	RCR05G472K	2	RESISTOR,FXD, CMPSN, 4.7K, 10%, 1/8W (V81349) 745-2365-000 A8R16 (EFF TO CI 72256)		1
163	RCR05G222K	2	RESISTOR,FXD, CMPSN, 2.2K, 10%, 1/8W (V81349) 745-2353-000 A8R16 (EFF CI 72256 TO CI 72275)		1
163	RCR05G102K	2	RESISTOR,FXD, CMPSN, 1K, 10%, 1/8W (V81349) 745-2341-000 A8R16 (EFF CI 72275)		1
164	1N459	2	SEMICONV DEVICE, (V07688) 353-0206-000 AACR18		1
165	RCR05G472K	2	RESISTOR,FXD, CMPSN, 4.7K, 10%, 1/8W (V81349) 745-2365-000 A8R15 (EFF TO CI 72256)		1
165	RCR05G222K	2	RESISTOR,FXD, CMPSN, 2.2K, 10%, 1/8W (V81349) 745-2353-000 A8R15 (EFF CI 72256 TO CI 72275)		1
165	RCR05G102K	2	RESISTOR,FXD, CMPSN, 1K, 10%, 1/8W (V81349) 745-2341-000 A8R15 (EFF CI 72275)		1
166	RCR05G472K	2	RESISTOR,FXD, CMPSN, 4.7K, 10%, 1/8W (V81349) 745-2365-000 A8R14 (EFF TO CI 72195)		1
166	RCR05G222K	2	RESISTOR,FXD, CMPSN, 2.2K, 10%, 1/8W (V81349) 745-2353-000 A8R14 (EFF CI 72195)		1
167	1N459	2	SEMICONV DEVICE, (V07688) 353-0206-000 AACR15		1
168	RCR05G102K	2	RESISTOR,FXD, CMPSN, 1K, 10%, 1/8W (V81349) 745-2341-000 A8R13		1
169	1N459	2	SEMICONV DEVICE, (V07688) 353-0206-000 AACR11		1
170	1N459	2	SEMICONV DEVICE, (V07688) 353-0206-000 AACR12		1
171	1N459	2	SEMICONV DEVICE, (V07688) 353-0206-000 AACR13		1
172	624-5746-001	2	HANDLE		1

GROUP ASSEMBLY PARTS LIST

FIG - ITEM	PART NO	INDENT	DESCRIPTION	USABLE ON CODE	UNITS PER ASSY
14	M551923-315	2	PIN, SPRING, SST, 0.078 DIA X 5/16 (V96906)		1
			311-0466-000 (AP)		
172A	372-2601-037	2	CONTACT, ELEC, 372-2601-037 (EFF CI 72256)		2
173	372-2234-010	2	CONTACT, ELEC, (V13499) 372-2234-010		44
174	372-2234-020	2	CONTACT, ELEC, (V13499) 372-2234-020		44
175	372-2623-031	2	HOUSING, CONN, EL, 372-2623-031		1
15	778-2928-003	1	CIRCUIT CARD ASSY, DECODER/DRIVER A7 (SEE FIG 1-17 FOR NHA)	A, B, C, D E, F, G, H J, K, L, M P, Q, X, Y Z, AA, AB AM, AN, AP AQ	RF
1	RG372K	2	INTEGRATED CKT, (V49956) 351-7494-010 A7U2		1
2	RG372K	2	INTEGRATED CKT, (V49956) 351-7494-010 A7U1		1
3	RG372K	2	INTEGRATED CKT, (V49956) 351-7494-010 A7U3		1
4	SG192	2	INTEGRATED CKT, (V93332) 351-7102-010 A7U6		1
5	SG192	2	INTEGRATED CKT, (V93332) 351-7102-010 A7U7		1
6	SG192	2	INTEGRATED CKT, (V93332) 351-7102-010 A7U8		1
7	SG142	2	INTEGRATED CKT, (V93332) 351-7094-010 A7U9		1
8	RG372K	2	INTEGRATED CKT, (V49956) 351-7494-010 A7U10		1
9	RCR07G222KS	2	RESISTOR, FXD, CMPSN, 2.2K, 10%, 1/4W (V81349) 745-0761-000 A7R5		1
10	RCR07G152KS	2	RESISTOR, FXD, CMPSN, 1.5K, 10%, 1/4W (V81349) 745-0755-000 A7R6 (EFF TO CI 72256)		1
11	2N2222A	2	TRANSISTOR, (V81350) 352-7500-280 A7Q3		1
12	RCR07G471KS	2	RESISTOR, FXD, CMPSN, 470 OHMS, 10%, 1/4W (V81349) 745-0737-000 A7R13		1
13	RCR07G222KS	2	RESISTOR, FXD, CMPSN, 2.2K, 10%, 1/4W (V81349) 745-0761-000 A7R14		1
14	2N3135	2	TRANSISTOR, (V07688) 352-0591-020 A7Q6 (EFF TO CI 72256)		1
14	2N2907A	2	TRANSISTOR, (V07688) 352-0551-010 A7Q6 (EFF CI 72256)		1
15	2C067103X0101A3	2	CAPACITOR, FXD, CER DIEL, 0.01UF, 20%, 100V (V56289) 913-4240-100 A7C3		1
16	2C067103X0101A3	2	CAPACITOR, FXD, CER DIEL, 0.01UF, 20%, 100V (V56289) 913-4240-100 A7C2		1
17	RCR20G152KS	2	RESISTOR, FXD, CMPSN, 1.5K, 10%, 1/2W (V81349) 745-1359-000 A7R10		1
18	RCR20G152KS	2	RESISTOR, FXD, CMPSN, 1.5K, 10%, 1/2W (V81349) 745-1359-000 A7R38		1
19	1N746A	2	SEMICOND DEVICE, (V07688) 353-2938-000 A7CR4		1
20	RCR07G152KS	2	RESISTOR, FXD, CMPSN, 1.5K, 10%, 1/4W (V81349) 745-0755-000 A7R30		1
21	2N3135	2	TRANSISTOR, (V07688) 352-0591-020 A7Q11 (EFF TO CI 72256)		1
21	2N2907A	2	TRANSISTOR, (V07688) 352-0551-010 A7Q11 (EFF CI 72256)		1
22	2C067103X0101A3	2	CAPACITOR, FXD, CER DIEL, 0.01UF, 20%, 100V (V56289) 913-4240-100 A7C7		1
23	RCR20G152KS	2	RESISTOR, FXD, CMPSN, 1.5K, 10%, 1/2W (V81349) 745-1359-000 A7R28		1
24	RCR07G121KS	2	RESISTOR, FXD, CMPSN, 120 OHMS, 10%, 1/4W (V81349) 745-0716-000 A7R29		1
25	RCR20G152KS	2	RESISTOR, FXD, CMPSN, 1.5K, 10%, 1/2W (V81349) 745-1359-000 A7R31		1
26	2C067103X0101A3	2	CAPACITOR, FXD, CER DIEL, 0.01UF, 20%, 100V (V56289) 913-4240-100 A7C8		1
27	2N3135	2	TRANSISTOR, (V07688) 352-0591-020 A7Q12 (EFF TO CI 72256)		1

GROUP ASSEMBLY PARTS LIST

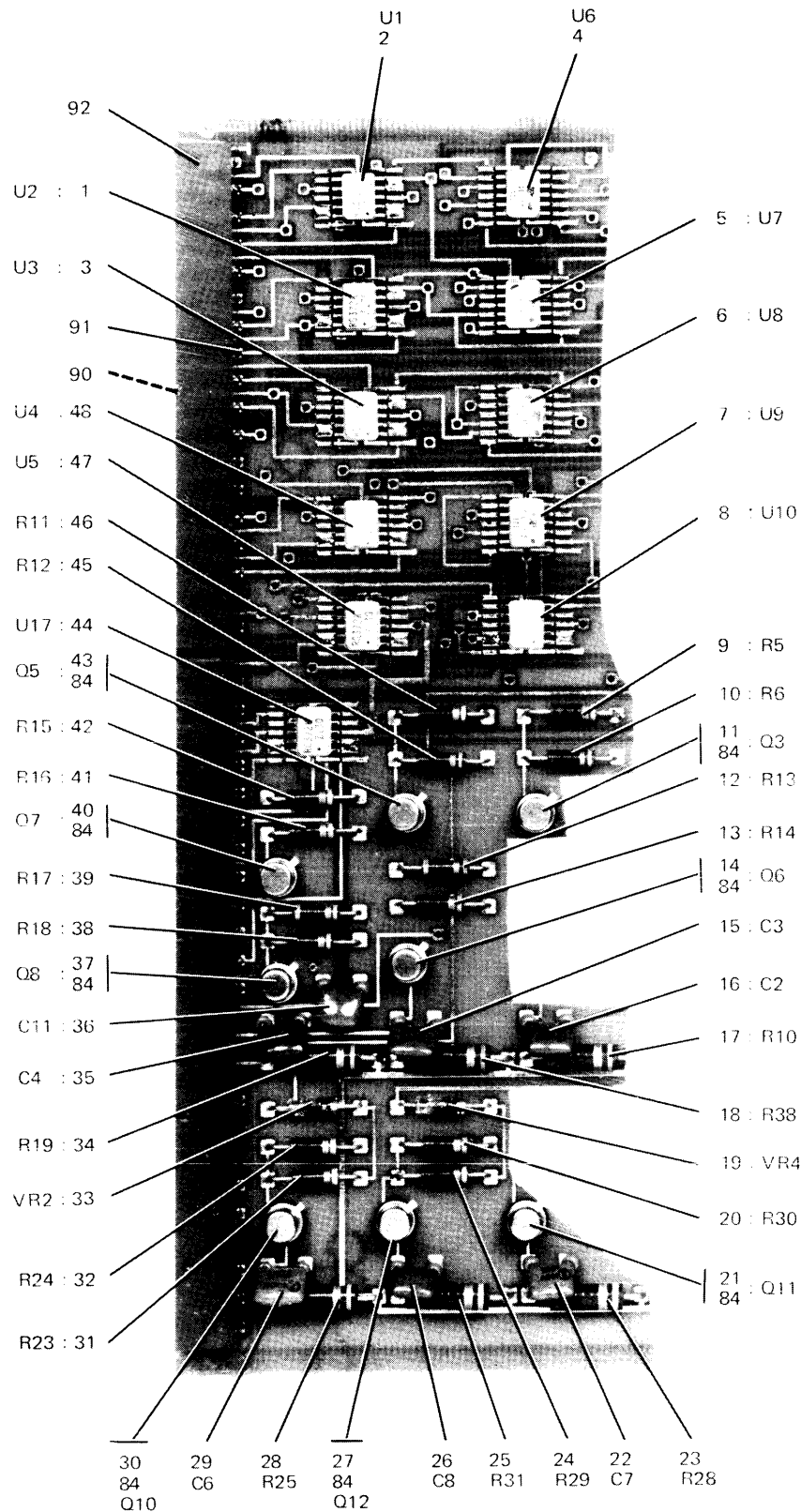

Decoder/Driver Circuit Card Assembly (A7) 778-2928-003  
Figure 15 (Sheet 1 of 2)

TP3-1030-027

GROUP ASSEMBLY PARTS LIST

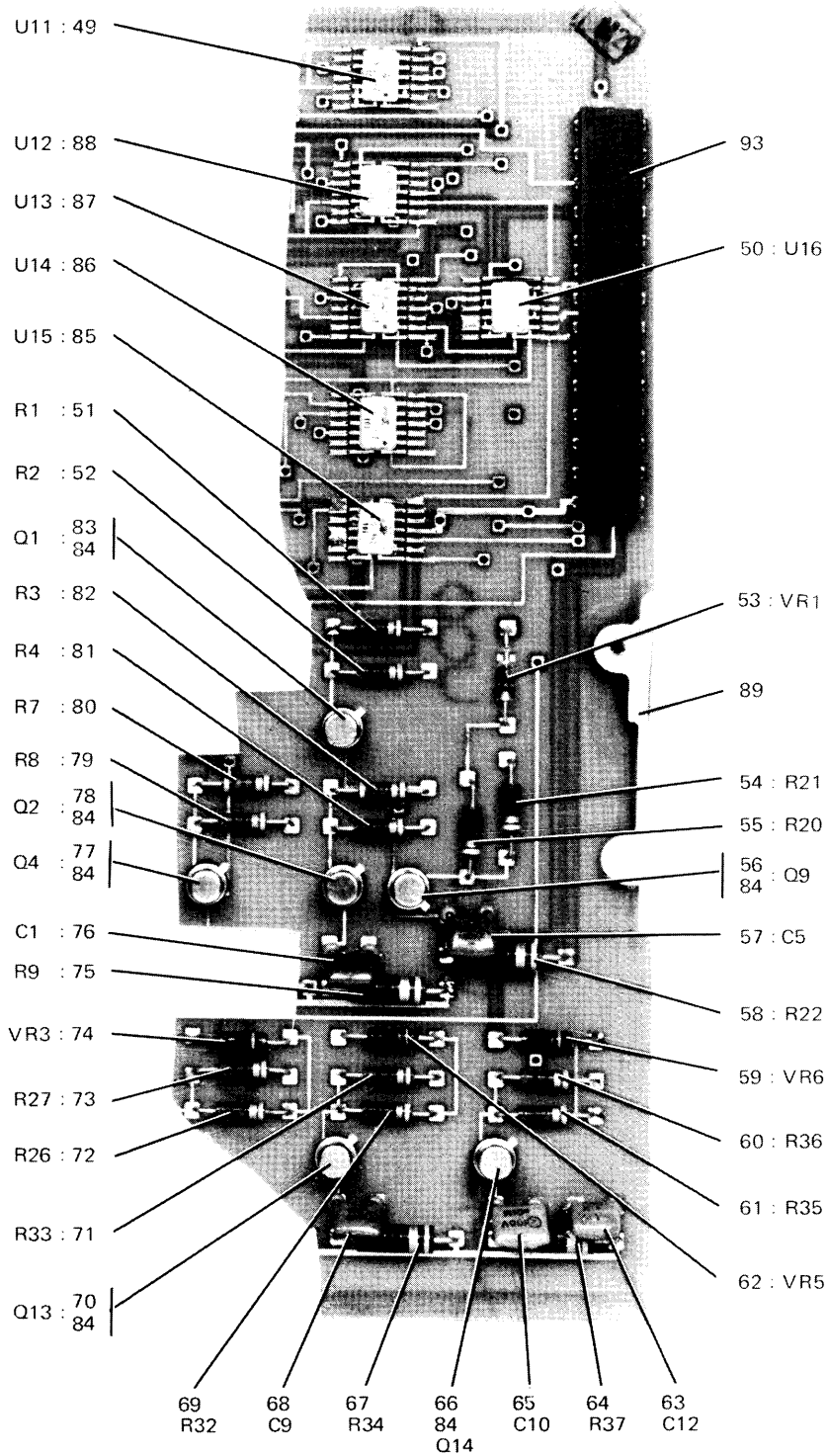

TP3-1030-027

Decoder/Driver Circuit Card Assembly (A7) 778-2928-003  
Figure 15 (Sheet 2 of 2)

## GROUP ASSEMBLY PARTS LIST

FIG - ITEM	PART NO	INDENT	DESCRIPTION	USABLE ON CODE	UNITS PER ASSY
15	27	2N2907A	2 TRANSISTOR, (V07688) 352-0551-010 A7Q12 (EFF CI 72256)		1
	28	RCR20G152KS	2 RESISTOR,FXD, CMPSN, 1.5K, 10%, 1/2W (V81349) 745-1359-000 A7R25		1
	29	2C067103X0101A3	2 CAPACITOR,FXD, CER DIEI, 0.01UF, 20%, 100V (V56289) 913-4240-100 A7C6		1
	30	2N3135	2 TRANSISTOR, (V07688) 352-0591-020 A7Q10		1
	31	RCR07G121KS	2 RESISTOR,FXD, CMPSN, 120 OHMS, 10%, 1/4W (V81349) 745-0716-000 A7R23		1
	32	RCR07G152KS	2 RESISTOR,FXD, CMPSN, 1.5K, 10%, 1/4W (V81349) 745-0755-000 A7R24		1
	33	1N746A	2 SEMICOND DEVICE, (V07688) 353-2938-000 A7VR2		1
	34	RCR20G152KS	2 RESISTOR,FXD, CMPSN, 1.5K, 10%, 1/2W (V81349) 745-1359-000 A7R19		1
	35	2C067103X0101A3	2 CAPACITOR,FXD, CER DIEI, 0.01UF, 20%, 100V (V56289) 913-4240-100 A7C4		1
	36	2C067104X0101A3	2 CAPACITOR,FXD, CER DIEI, 0.1UF, 20%, 100V (V56289) 913-4240-040 A7C11		1
	37	2N3135	2 TRANSISTOR, (V07688) 352-0591-020 A7Q8 (EFF TO CI 72256)		1
	37	2N2907A	2 TRANSISTOR, (V07688) 352-0551-010 A7Q8 (EFF CI 72256)		1
	38	RCR07G222KS	2 RESISTOR,FXD, CMPSN, 2.2K, 10%, 1/4W (V81349) 745-0761-000 A7R18		1
	39	RCR07G471KS	2 RESISTOR,FXD, CMPSN, 470 OHMS, 10%, 1/4W (V81349) 745-0737-000 A7R17		1
	40	2N2222A	2 TRANSISTOR, (V81350) 352-7500-280 A7Q7		1
	41	RCR07G152KS	2 RESISTOR,FXD, CMPSN, 1.5K, 10%, 1/4W (V81349) 745-0755-000 A7R16 (EFF TO CI 72256)		1
	42	RCR07G222KS	2 RESISTOR,FXD, CMPSN, 2.2K, 10%, 1/4W (V81349) 745-0761-000 A7R15		1
	43	2N2222A	2 TRANSISTOR, (V81350) 352-7500-280 A7Q5		1
	44	RG372K	2 INTEGRATED CKT, (V49956) 351-7494-010 A7U17		1
	45	RCR07G152KS	2 RESISTOR,FXD, CMPSN, 1.5K, 10%, 1/4W (V81349) 745-0755-000 A7R12 (EFF TO CI 72256)		1
	46	RCR07G222KS	2 RESISTOR,FXD, CMPSN, 2.2K, 10%, 1/4W (V81349) 745-0761-000 A7R11		1
	47	RG372K	2 INTEGRATED CKT, (V49956) 351-7494-010 A7U5		1
	48	RG372K	2 INTEGRATED CKT, (V49956) 351-7494-010 A7U4		1
	49	SG142	2 INTEGRATED CKT, (V93332) 351-7094-010 A7U11		1
	50	RG372K	2 INTEGRATED CKT, (V49956) 351-7494-010 A7U16		1
	51	RCR07G222KS	2 RESISTOR,FXD, CMPSN, 2.2K, 10%, 1/4W (V81349) 745-0761-000 A7R1		1
	52	RCR07G152KS	2 RESISTOR,FXD, CMPSN, 1.5K, 10%, 1/4W (V81349) 745-0755-000 A7R2 (EFF TO CI 72256)		1
	53	1N746A	2 SEMICOND DEVICE, (V07688) 353-2938-000 A7VR1		1
	54	RCR07G152KS	2 RESISTOR,FXD, CMPSN, 1.5K, 10%, 1/4W (V81349) 745-0755-000 A7R21		1
	55	RCR07G121KS	2 RESISTOR,FXD, CMPSN, 120 OHMS, 10%, 1/4W (V81349) 745-0716-000 A7R20		1
	56	2N3135	2 TRANSISTOR, (V07688) 352-0591-020 A7Q9		1
	57	2C067103X0101A3	2 CAPACITOR,FXD, CER DIEI, 0.01UF, 20%, 100V (V56289) 913-4240-100 A7C5		1
	58	RCR20G152KS	2 RESISTOR,FXD, CMPSN, 1.5K, 10%, 1/2W (V81349) 745-1359-000 A7R22		1
	59	1N746A	2 SEMICOND DEVICE, (V07688) 353-2938-000 A7VR6		1
	60	RCR07G152KS	2 RESISTOR,FXD, CMPSN, 1.5K, 10%, 1/4W (V81349) 745-0755-000 A7R36		1
	61	RCR07G121KS	2 RESISTOR,FXD, CMPSN, 120 OHMS, 10%, 1/4W (V81349) 745-0716-000 A7R35		1
	62	1N746A	2 SEMICOND DEVICE, (V07688) 353-2938-000 A7VR5		1
	63	2C067104X0101A3	2 CAPACITOR,FXD, CER DIEI, 0.1UF, 20%, 100V (V56289) 913-4240-040 A7C12		1

GROUP ASSEMBLY PARTS LIST

FIG - ITEM	PART NO	INDENT	DESCRIPTION	USABLE ON CODE	UNITS PER ASSY
15 64	RCR20G152KS	2	RESISTOR,FXD, CMPSN, 1.5K, 10%, 1/2W (V81349) 745-1359-000 A7R37		1
65	2C067103X0101A3	2	CAPACITOR,FXD, CER DIEI, 0.01UF, 20%, 100V (V56289) 913-4240-100 A7C10		1
66	2N3135	2	TRANSISTOR, (V07688) 352-0591-020 A7Q14 (EFF TO CI 72256)		1
66	2N2907A	2	TRANSISTOR, (V07688) 352-0551-010 A7Q14 (EFF CI 72256)		1
67	RCR20G152KS	2	RESISTOR,FXD, CMPSN, 1.5K, 10%, 1/2W (V81349) 745-1359-000 A7R34		1
68	2C067103X0101A3	2	CAPACITOR,FXD, CER DIEI, 0.01UF, 20%, 100V (V56289) 913-4240-100 A7C9		1
69	RCR07G121KS	2	RESISTOR,FXD, CMPSN, 120 OHMS, 10%, 1/4W (V81349) 745-0716-000 A7R32		1
70	2N3135	2	TRANSISTOR, (V07688) 352-0591-020 A7Q13 (EFF TO CI 72256)		1
70	2N2907A	2	TRANSISTOR, (V07688) 352-0551-010 A7Q13 (EFF CI 72256)		1
71	RCR07G152KS	2	RESISTOR,FXD, CMPSN, 1.5K, 10%, 1/4W (V81349) 745-0755-000 A7R33		1
72	RCR07G121KS	2	RESISTOR,FXD, CMPSN, 120 OHMS, 10%, 1/4W (V81349) 745-0716-000 A7R26		1
73	RCR07G152KS	2	RESISTOR,FXD, CMPSN, 1.5K, 10%, 1/4W (V81349) 745-0755-000 A7R27		1
74	1N746A	2	SEMICOND DEVICE, (V07688) 353-2938-000 A7VR3		1
75	RCR20G152KS	2	RESISTOR,FXD, CMPSN, 1.5K, 10%, 1/2W (V81349) 745-1359-000 A7R9		1
76	2C067103X0101A3	2	CAPACITOR,FXD, CER DIEI, 0.01UF, 20%, 100V (V56289) 913-4240-100 A7C1		1
77	2N3135	2	TRANSISTOR, (V07688) 352-0591-020 A7Q4 (EFF TO CI 72256)		1
77	2N2907A	2	TRANSISTOR, (V07688) 352-0551-010 A7Q4 (EFF CI 72256)		1
78	2N3135	2	TRANSISTOR, (V07688) 352-0591-020 A7Q2 (EFF TO CI 72256)		1
78	2N2907A	2	TRANSISTOR, (V07688) 352-0551-010 A7Q2 (EFF CI 72256)		1
79	RCR07G222KS	2	RESISTOR,FXD, CMPSN, 2.2K, 10%, 1/4W (V81349) 745-0761-000 A7R8		1
80	RCR07G471KS	2	RESISTOR,FXD, CMPSN, 470 OHMS, 10%, 1/4W (V81349) 745-0737-000 A7R7		1
81	RCR07G222KS	2	RESISTOR,FXD, CMPSN, 2.2K, 10%, 1/4W (V81349) 745-0761-000 A7R4		1
82	RCR07G471KS	2	RESISTOR,FXD, CMPSN, 470 OHMS, 10%, 1/4W (V81349) 745-0737-000 A7R3		1
83	2N2222A	2	TRANSISTOR, (V81350) 352-7500-280 A7Q1		1
84	7717-130DAP	2	INSULATOR,DISK, (V13103) 352-9552-580		14
85	SG142	2	INTEGRATED CKT, (V93332) 351-7094-010 A7U15		1
86	SG142	2	INTEGRATED CKT, (V93332) 351-7094-010 A7U14		1
87	SG142	2	INTEGRATED CKT, (V93332) 351-7094-010 A7U13		1
88	SG192	2	INTEGRATED CKT, (V93332) 351-7102-010 A7U12		1
89	77A-2940-002	2	HANDLE		1
	MS16562-199	2	PIN,SPR, SST, 0.078 DIA X 1/4 (V96906) 311-0355-000 (AP)		1
90	372-2234-010	2	CONTACT,ELEC, (V13499) 372-2234-010		44
91	372-2234-020	2	CONTACT,ELEC, (V13499) 372-2234-020		30
92	372-2623-052	2	HOUSING,CONN,EL, 372-2623-052		1
93	372-2621-023	2	HOUSING,CONN, 372-2621-023		1



GROUP ASSEMBLY PARTS LIST

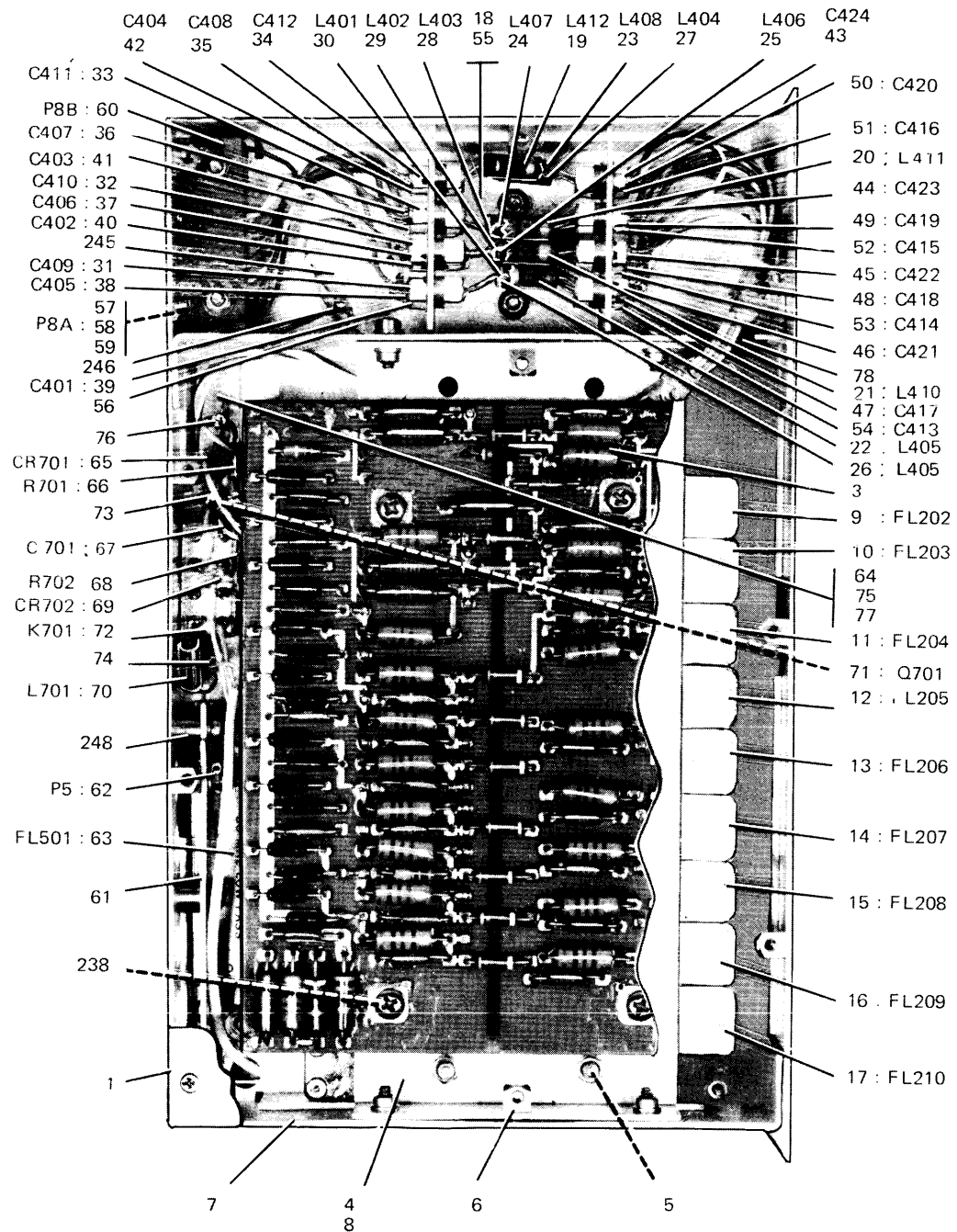

TP3-1031-047

RF Module Assembly (A6) 790-1048-008, -010  
Figure 16 (Sheet 1 of 4)

GROUP ASSEMBLY PARTS LIST

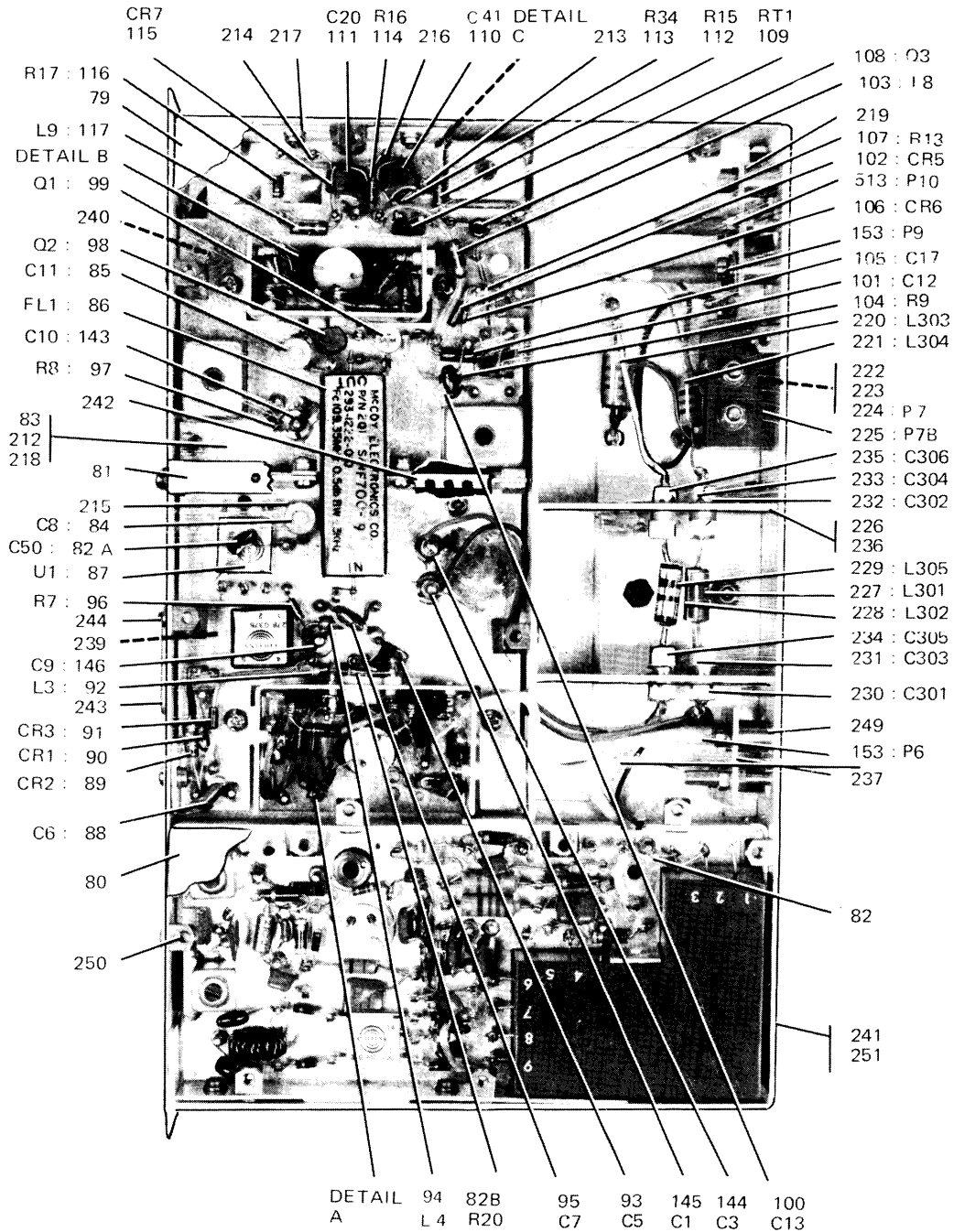

TP3-1031-047

RF Module Assembly (A6) 790-1048-008, -010  
Figure 16 (Sheet 2 of 4)

GROUP ASSEMBLY PARTS LIST

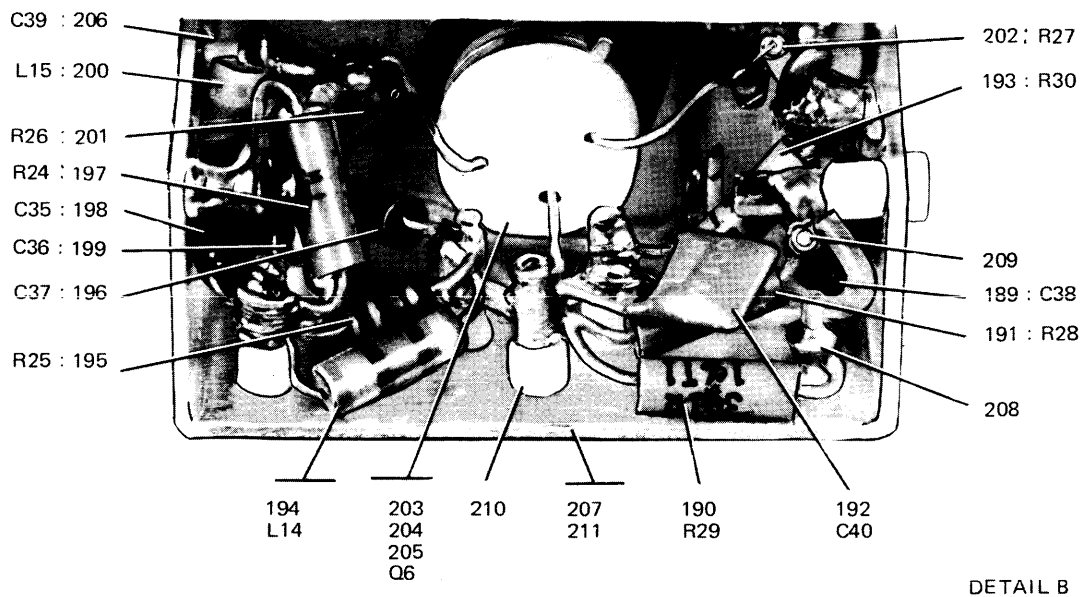
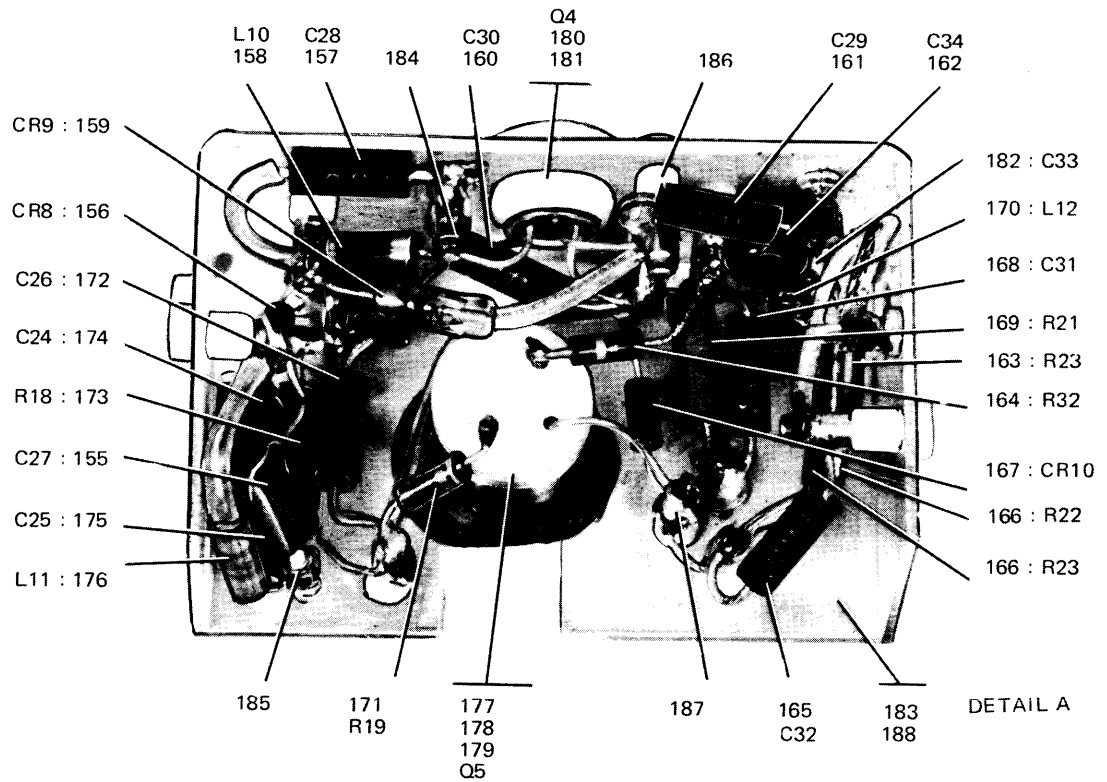

TP3-1031-047

RF Module Assembly (A6) 790-1048-008, -010  
Figure 16 (Sheet 3 of 4)

GROUP ASSEMBLY PARTS LIST

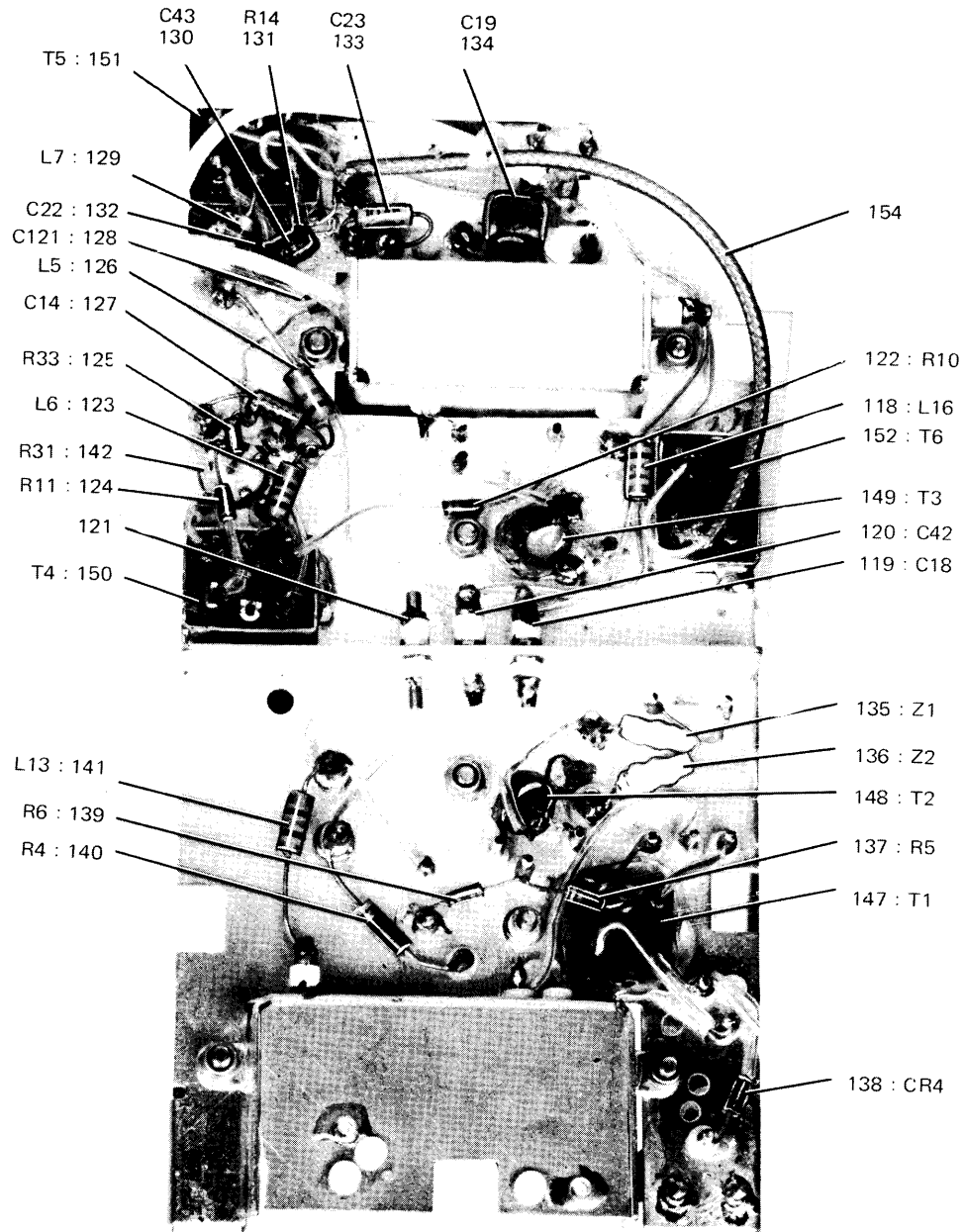

DETAIL C

TP3-1031-047

RF Module Assembly (A6) 790-1048-008, -010  
Figure 16 (Sheet 4 of 4)

GROUP ASSEMBLY PARTS LIST

FIG - ITEM	PART NO	INDENT	DESCRIPTION	USABLE ON CODE	UNITS PER ASSY
16 -	790-1048-008	1	MODULE ASSY, RF, A6 (SEE FIG 1-18 FOR NHA)	R	RF
1	609-1635-001	2	COVER, FILTER		1
	P330-2284-000	2	SCREW, MACH, SST, 2-56 X 3/16 (V77250) 330-2284-000 (AP)		10
2	606-9880-002	2	ELECTRONIC COMPONENT ASSY	R	1
2	606-9880-003	2	ELECTRONIC COMPONENT ASSY	S	1
3	778-2934-002	3	CIRCUIT CARD ASSY, DIODE SWITCHING (SEE FIG 17)	R	1
3	778-2934-003	3	CIRCUIT CARD ASSY, DIODE SWITCHING (SEE FIG 17)	S	1
4	609-1640-001	3	BRACKET, FILTER	R	1
4	790-2017-001	3	BRACKET, FILTER, (EFF TO CI 72323)	S	1
4	609-1640-001	3	BRACKET, FILTER, (EFF CI 72323)		1
	P330-2290-000	3	SCREW, MACH, SST, 4-40 X 1/4 (V77250) 330-2290-000 (AP)		2
	MS51957-13	3	SCREW, MACH, STL, 4-40 X 1/4 (V96906) 343-0133-000 (AP)		1
	MS35338-135	3	WASHER, LOCK, SST, 0.115 ID X 0.209 OD (V96906) 310-0279-000 (AP)		1
5	609-1636-001	4	POST	R	4
6	609-1638-001	4	FASTENER, ANGLE	R	2
6	609-1638-001	4	FASTENER, ANGLE	S	1
7	R22NCFMA1-40	4	NUT, SLFLKG, CD PL STL, 4-40 (V72962) 333-0839-000		4
8	609-1634-001	4	BRACKET, FILTER	R	1
8	790-1374-001	4	BRACKET, FILTER	S	1
9	A275	3	FILTER, LP, (V81815) 241-0685-010 A6FL202	R	1
10	A251	3	FILTER, BANDPASS, (V81815) 241-0619-010 A6FL203		1
11	A252	3	FILTER, BANDPASS, (V81815) 241-0619-020 A6FL204		1
12	A253	3	FILTER, BANDPASS, (V81815) 241-0619-030 A6FL205		1
13	A254	3	FILTER, BANDPASS, (V81815) 241-0619-040 A6FL206		1
14	A255	3	FILTER, BANDPASS, (V81815) 241-0619-050 A6FL207		1
15	A256	3	FILTER, BANDPASS, (V81815) 241-0619-060 A6FL208		1
16	A257	3	FILTER, BANDPASS, (V81815) 241-0619-070 A6FL209		1
17	A258	3	FILTER, BANDPASS, (V81815) 241-0619-080 A6FL210		1
	P313-0132-000	3	NUT, PLAIN, HEX, SST, 4-40 (V77250) 313-0132-000 (AP FOR 9-17)		18
	310-0278-000	3	WASHER, LOCK, SST, 0.115 ID X 0.202 OD (V70318) 310-0278-000 (AP FOR 9-17)		18
18	790-1393-004	3	FILTER NETWORK	R	1
18	790-1393-005	3	FILTER NETWORK	S	1
	68-1660-26	3	NUT, SLFLKG, HEX, AL, 2-56 (V72962) 333-0604-000 (AP)		2
	MS51959-3	3	SCREW, MACH, SST, 2-56 X 1/4 (V96906) 342-0133-000 (AP)		2
19	MS90538-06	4	COIL, RF, 56UH (V96906) 240-2510-000 A6L412	S	1
20	MS90538-06	4	COIL, RF, 56UH (V96906) 240-2510-000 A6L411	S	1
21	MS90538-06	4	COIL, RF, 56UH (V96906) 240-2510-000 A6L410		1
22	MS90538-06	4	COIL, RF, 56UH (V96906) 240-2510-000 A6L409		1
23	MS90538-06	4	COIL, RF, 56UH (V96906) 240-2510-000 A6L408		1
24	MS90538-06	4	COIL, RF, 56UH (V96906) 240-2510-000 A6L407		1
25	MS90538-06	4	COIL, RF, 56UH (V96906) 240-2510-000 A6L406		1
26	MS90538-06	4	COIL, RF, 56UH (V96906) 240-2510-000 A6L405		1
27	MS90538-06	4	COIL, RF, 56UH (V96906) 240-2510-000 A6L404		1
28	MS90538-06	4	COIL, RF, 56UH (V96906) 240-2510-000 A6L403		1
29	MS90538-06	4	COIL, RF, 56UH (V96906) 240-2510-000 A6L402		1
30	MS90537-49	4	COIL, RF, 1000UH (V96906) 240-2715-490 A6L401		1
31	2465-009W5T0102P	4	CAPACITOR, FXD, CER DIEL, 1000PF, GMV, 500V (V72982) 913-3209-000 A6C409		1
32	2465-009W5T0102P	4	CAPACITOR, FXD, CER DIEL, 1000PF, GMV, 500V (V72982) 913-3209-000 A6C410		1
33	2465-009W5T0102P	4	CAPACITOR, FXD, CER DIEL, 1000PF, GMV, 500V (V72982) 913-3209-000 A6C411	S	1
34	2465-009W5T0102P	4	CAPACITOR, FXD, CER DIEL, 1000PF, GMV, 500V (V72982) 913-3209-000 A6C412	S	1

GROUP ASSEMBLY PARTS LIST

FIG - ITEM	PART NO	INDENT	DESCRIPTION	USABLE ON CODE	UNITS PER ASSY
16	35	2465-009W5T0102P	4 CAPACITOR,FXD, CER DIEL, 1000PF, GMV, 500V (V72982) 913-3209-000 A6C408		1
	36	2465-009W5T0102P	4 CAPACITOR,FXD, CER DIEL, 1000PF, GMV, 500V (V72982) 913-3209-000 A6C407		1
	37	2465-009W5T0102P	4 CAPACITOR,FXD, CER DIEL, 1000PF, GMV, 500V (V72982) 913-3209-000 A6C406		1
	38	2465-009W5T0102P	4 CAPACITOR,FXD, CER DIEL, 1000PF, GMV, 500V (V72982) 913-3209-000 A6C405		1
	39	2465-009W5T0102P	4 CAPACITOR,FXD, CER DIEL, 1000PF, GMV, 500V (V72982) 913-3209-000 A6C401		1
	40	2465-009W5T0102P	4 CAPACITOR,FXD, CER DIEL, 1000PF, GMV, 500V (V72982) 913-3209-000 A6C402		1
	41	2465-009W5T0102P	4 CAPACITOR,FXD, CER DIEL, 1000PF, GMV, 500V (V72982) 913-3209-000 A6C403		1
	42	2465-009W5T0102P	4 CAPACITOR,FXD, CER DIEL, 1000PF, GMV, 500V (V72982) 913-3209-000 A6C404		1
	43	2465-009W5T0102P	4 CAPACITOR,FXD, CER DIEL, 1000PF, GMV, 500V (V72982) 913-3209-000 A6C424	S	1
	44	2465-009W5T0102P	4 CAPACITOR,FXD, CER DIEL, 1000PF, GMV, 500V (V72982) 913-3209-000 A6C423	S	1
	45	2465-009W5T0102P	4 CAPACITOR,FXD, CER DIEL, 1000PF, GMV, 500V (V72982) 913-3209-000 A6C422		1
	46	2465-009W5T0102P	4 CAPACITOR,FXD, CER DIEL, 1000PF, GMV, 500V (V72982) 913-3209-000 A6C421		1
	47	2465-009W5T0102P	4 CAPACITOR,FXD, CER DIEL, 1000PF, GMV, 500V (V72982) 913-3209-000 A6C417		1
	48	2465-009W5T0102P	4 CAPACITOR,FXD, CER DIEL, 1000PF, GMV, 500V (V72982) 913-3209-000 A6C418		1
	49	2465-009W5T0102P	4 CAPACITOR,FXD, CER DIEL, 1000PF, GMV, 500V (V72982) 913-3209-000 A6C419		1
	50	2465-009W5T0102P	4 CAPACITOR,FXD, CER DIEL, 1000PF, GMV, 500V (V72982) 913-3209-000 A6C420		1
	51	2465-009W5T0102P	4 CAPACITOR,FXD, CER DIEL, 1000PF, GMV, 500V (V72982) 913-3209-000 A6C416		1
	52	2465-009W5T0102P	4 CAPACITOR,FXD, CER DIEL, 1000PF, GMV, 500V (V72982) 913-3209-000 A6C415		1
	53	2465-009W5T0102P	4 CAPACITOR,FXD, CER DIEL, 1000PF, GMV, 500V (V72982) 913-3209-000 A6C414		1
	54	2465-009W5T0102P	4 CAPACITOR,FXD, CER DIEL, 1000PF, GMV, 500V (V72982) 913-3209-000 A6C413		1
	55	609-1561-001	4 BRACKET,FILTER		1
	56	4007-4HT	4 TERMINAL,LUG, (V77147) 304-0015-000		1
		MS51957-13	4 SCREW,MACH, STL, 4-40 X 1/4 (V96906) 343-0133-000 (AP)		1
		MS35338-135	4 WASHER,LOCK, SST, 0.115 ID X 0.209 OD (V96906) 310-0279-000 (AP)		1
	57	372-2255-020	4 CONTACT,ELEC, 372-2255-020		11
	58	790-1377-001	4 HOUSING,CONN, A6P8A		1
	59	790-1365-001	4 SHIM		1
	60	790-1377-002	4 HOUSING,CONN, A6P8B		1
		68-1660-26	4 NUT,SLFLKG,HEX, AL, 2-56 (V72962) 333-0604-000 (AP FOR 58-60)		2
		310-6320-000	4 WASHER,FLAT, SST, 0.092 ID X 0.218 OD (V79807) 310-6320-000 (AP FOR 58-60)		2
		PJ42-0149-000	4 SCREW,MACH, NP BRS, 2-56 X 7/8 (V77250) 342-0149-000 (AP FOR 58-60)	R	2
		MS51957-10	4 SCREW,MACH, SST, 2-56 X 7/8 (V96906) 343-0130-000 (AP FOR 58-60)	S	2
	61	790-1350-001	2 BRACKET		1
		MS51957-13	2 SCREW,MACH, STL, 4-40 X 1/4 (V96906) 343-0133-000 (AP)		3
		MS35338-135	2 WASHER,LOCK, SST, 0.115 ID X 0.209 OD (V96906) 310-0279-000 (AP)		3

## GROUP ASSEMBLY PARTS LIST

FIG - ITEM	PART NO	INDENT	DESCRIPTION	USABLE ON CODE	UNITS PER ASSY
16	62	141-1002-0002	2 CONNECTOR, RCPT, ELEC (V98278) 357-7353-010 A6P5		1
	63	A188	2 FILTER, LP, (V81815) 241-0609-010 A6FL501		1
		MS35649-244	2 NUT, PLAIN, HEX, SST, 4-40 (V96906) 313-0043-000 (AP)		2
		MS35338-135	2 WASHER, LOCK, SST, 0.115 ID X 0.209 OD (V96906) 310-0279-000 (AP)		2
		P330-2290-000	2 SCREW, MACH, SST, 4-40 X 1/4 (V77250) 330-2290-000 (AP)		2
	64	609-1644-001	2 SWITCH, ANTENNA	S	1
		MS51957-2	2 SCREW, MACH, SST, 2-56 X 3/16 (V96906) 343-0123-000 (AP)	S	2
		MS35338-96	2 WASHER, LOCK, BRZ, 0.088 ID X 0.175 OD (V96906) 310-0074-000 (AP)	S	2
		4040-2HDSPL	2 TERMINAL, LUG, (V77147) 304-0331-000 (AP)	S	1
	65	1N459	3 SEMICOND DEVICE, (V07688) 353-0206-000 A6CR701	S	1
	66	RCR07G103KS	3 RESISTOR, FXD, CMPSN, 10K, 10%, 1/4W (V81349) 745-0785-000 A6R701	S	1
	67	2C067104X0101A3	3 CAPACITOR, FXD, CER DIE, 0.1UF, 20%, 100V (V56289) 913-4240-040 A6C701	S	1
	68	RCR07G100KS	3 RESISTOR, FXD, CMPSN, 10 OHMS, 10%, 1/4W (V81349) 745-0677-000 A6R702	S	1
	69	1N459	3 SEMICOND DEVICE, (V07688) 353-0206-000 A6CR702	S	1
	70	MS90537-25	3 COIL, RF, 10UH (V96906) 240-2715-250 A6L701	S	1
	71	2N2222A	3 TRANSISTOR, (V81350) 352-7500-280 A6Q701	S	1
	72	3SAV1556A2	3 RELAY, AMT, (V01526) 974-1065-260 A6K701	S	1
	73	FTSM52WHT	3 TERMINAL, FEEDTH, (V98291) 306-1039-000	S	1
		MS51957-2	3 SCREW, MACH, SST, 2-56 X 3/16 (V96906) 343-0123-000 (AP FOR 72,73)	S	2
		MS35338-96	3 WASHER, LOCK, BRZ, 0.088 ID X 0.175 OD (V96906) 310-0074-000 (AP FOR 72,73)	S	2
	74	TF300	3 TERMINAL, STUD, (V98291) 306-1018-000	S	1
		P313-0484-010	3 NUT, PLAIN, HEX, NP BRZ, 2-56 (V77250) 313-0484-010 (AP)	S	1
	75	609-1642-001	3 BRACKET, RELAY	S	1
	76	SL481-491WHT	4 TERMINAL, STUD, (V12615) 306-2511-100	S	6
	77	609-1566-001	4 BRACKET, RELAY	S	1
	78	DIE30071	2 RUBBER CHANNEL, (V75183) 200-5310-000		AR
	79	609-1632-001	2 COVER, CHASSIS	S	1
	80	609-1633-001	2 COVER, MIXER		1
		P330-2284-000	2 SCREW, MACH, SST, 2-56 X 3/16 (V77250) 330-2284-000 (AP)	R	9
		P330-2284-000	2 SCREW, MACH, SST, 2-56 X 3/16 (V77250) 330-2284-000 (AP FOR 79,80)	S	15
	81	790-2059-001	2 SPACER, PLATE		1
		P342-0143-000	2 SCREW, MACH, NP BRZ, 2-56 X 1/4 (V77250) 342-0143-000 (AP)		2
	82	609-1643-001	2 MIXER, VLF, (SEE FIG 18)	S	1
		MS51959-2	2 SCREW, MACH, SST, 2-56 X 3/16 (V96906) 342-0132-000 (AP)		2
		P343-0298-000	2 SCREW, MACH, NP BRZ, 2-56 X 3/16 (V77250) 343-0298-000 (AP)		2
		MS35338-96	2 WASHER, LOCK, BRZ, 0.088 ID X 0.175 OD (V96906) 310-0074-000 (AP)		2
	82A	DM5C010D050WV	2 CAPACITOR, FXD, MICA DIE, 1PF, 0.5PF, 50V (V72136) 912-4141-060 A6C50		1
	82B	RCR05G222JS	2 RESISTOR, FXD, CMPSN, 2.2K, 5%, 1/8W (V81349) 745-1863-570 A6R20		AR
	82B	RCR05G272JS	2 RESISTOR, FXD, CMPSN, 2.7K, 5%, 1/8W (V81349) 745-1863-590 A6R20		AR
	82B	RCR05G332JS	2 RESISTOR, FXD, CMPSN, 3.3K, 5%, 1/8W (V81349) 745-1863-610 A6R20		AR
	82B	RCR05G392JS	2 RESISTOR, FXD, CMPSN, 3.9K, 5%, 1/8W (V81349) 745-1863-630 A6R20		AR

GROUP ASSEMBLY PARTS LIST

FIG - ITEM	PART NO	INDENT	DESCRIPTION	USABLE ON CODE	UNITS PER ASSY
16	82B RCR05G472JS	2	RESISTOR,FXD, CMPSN, 4.7K, 5%, 1/8W (V81349) 745-1863-650 A6R20		AR
	82B RCR05G562JS	2	RESISTOR,FXD, CMPSN, 5.6K, 5%, 1/8W (V81349) 745-1863-670 A6R20		AR
	82B RCR05G682JS	2	RESISTOR,FXD, CMPSN, 6.8K, 5%, 1/8W (V81349) 745-1863-690 A6R20		AR
	82B RCR05G752JS	2	RESISTOR,FXD, CMPSN, 7.5K, 5%, 1/8W (V81349) 745-1863-700 A6R20		AR
	82B RCR05G822JS	2	RESISTOR,FXD, CMPSN, 8.2K, 5%, 1/8W (V81349) 745-1863-710 A6R20		AR
	82B RCR05G103JS	2	RESISTOR,FXD, CMPSN, 10K, 5%, 1/8W (V81349) 745-1863-730 A6R20		AR
	82B RCR05G123JS	2	RESISTOR,FXD, CMPSN, 12K, 5%, 1/8W (V81349) 745-1863-750 A6R20		AR
	82B RCR05G153JS	2	RESISTOR,FXD, CMPSN, 15K, 5%, 1/8W (V81349) 745-1863-770 A6R20		AR
	83 606-9877-002	2	MIXER,RF		1
	MS51959-2	2	SCREW,MACH, SST, 2-56 X 3/16 (V96906) 342-0132-000 (AP)		2
	P343-0298-000	2	SCREW,MACH, NP BR5, 2-56 X 3/16 (V77250) 343-0298-000 (AP)		4
	P347-0103-000	2	SCREW,MACH, NP BR5, 2-56 X 3/16 (V77250) 347-0103-000 (AP)		4
	310-0075-000	2	WASHER,LOCK, BR7, 0.088 ID X 0.165 OD (V79807) 310-0075-000 (AP)		4
	84 538002C0P089R	3	CAPACITOR,VAR, CER DIEL, 2 TO 8PF, 350V (V72982) 917-1228-000 A6C8		1
	85 538002C0P089R	3	CAPACITOR,VAR, CER DIEL, 2 TO 8PF, 350V (V72982) 917-1228-000 A6C11		1
	86 2Q1	3	FILTER,BANDPASS, (V00136) 293-1222-010 A6FL1		1
	68-1660-26	3	NUT,SLFLKG,HEX, AL, 2-56 (V72962) 333-0604-000 (AP)		4
	MS51957-2	3	SCREW,MACH, SST, 2-56 X 3/16 (V96906) 343-0123-000 (AP)		2
	87 350-3072-020	3	MICROCIRCUIT, 350-3072-020 A6U1		1
	88 2C067104X0101A3	3	CAPACITOR,FXD, CER DIEL, 0.1UF, 20%, 100V (V56289) 913-4240-040 A6C6		1
	89 1N3070	3	SEMICONV DEVICE, (V07688) 353-3083-000 A6CR2		1
	90 1N3070	3	SEMICONV DEVICE, (V07688) 353-3083-000 A6CR1		1
	91 1N5767	3	SEMICONV DEVICE, (V07688) 922-6119-010 A6CR3		1
	92 240-2711-300	3	COIL,RF, 27UH (V99800) 240-2711-300 A6L3		1
	93 2C067103X0101A3	3	CAPACITOR,FXD, CER DIEL, 0.01UF, 20%, 100V (V56289) 913-4240-100 A6C5		1
	94 240-2711-300	3	COIL,RF, 27UH (V99800) 240-2711-300 A6L4		1
	95 2C067104X0101A3	3	CAPACITOR,FXD, CER DIEL, 0.1UF, 20%, 100V (V56289) 913-4240-040 A6C7		1
	96 RCR05G220JS	3	RESISTOR,FXD, CMPSN, 22 OHMS, 5%, 1/8W (V81349) 745-1863-090 A6R7		1
	97 RCR05G332JS	3	RESISTOR,FXD, CMPSN, 3.3K, 5%, 1/8W (V81349) 745-1863-610 A6R8		1
	98 FN2173	3	TRANSISTOR, (V17896) 352-0756-070 A6Q2		1
	99 FN2173	3	TRANSISTOR, (V17896) 352-0756-070 A6Q1		1
	100 DM5F101J050WV	3	CAPACITOR,FXD, MICA DIEL, 100PF, 5%, 50V (V72136) 912-4141-050 A6C13		1
	101 DM5F101J050WV	3	CAPACITOR,FXD, MICA DIEL, 100PF, 5%, 50V (V72136) 912-4141-050 A6C12		1
	102 1N5767	3	SEMICONV DEVICE, (V07688) 922-6119-010 A6CR5		1
	103 MS75085-07	3	COIL,RF, 100UH (V96906) 240-2047-000 A6L8		1
	104 RCR05G100JS	3	RESISTOR,FXD, CMPSN, 10 OHMS, 5%, 1/8W (V81349) 745-1863-010 A6R9		1
	105 C22A103K	3	CAPACITOR,FXD, CER DIEL, 10.000PF, 10%, 100V (V16546) 913-5661-120 A6C17		1
	106 1N5767	3	SEMICONV DEVICE, (V07688) 922-6119-010 A6CR6		1



## GROUP ASSEMBLY PARTS LIST

FIG - ITEM	PART NO	INDENT	DESCRIPTION	USABLE ON CODE	UNITS PER ASSY
16 107	RCR05G100JS	3	RESISTOR,FXD, CMPSN, 10 OHMS, 5%, 1/8W (V81349) 745-1863-010 A6R13		1
108	FN2173	3	TRANSISTOR, (V17896) 352-0756-070 A6Q3		1
109	23TD21	3	RESISTOR,THRM, 270 OHMS, 10%, 3.8MW (V90634) 714-0007-030 A6RT1		1
110	2C067104X0101A3	3	CAPACITOR,FXD, CER DIEI, 0.1UF, 20%, 100V (V56289) 913-4240-040 A6C41		1
111	2C067104X0101A3	3	CAPACITOR,FXD, CER DIEI, 0.1UF, 20%, 100V (V56289) 913-4240-040 A6C20		1
112	RCR05G331JS	3	RESISTOR,FXD, CMPSN, 330 OHMS, 5%, 1/8W (V81349) 745-1863-370 A6R15		1
113	RCR05G102JS	3	RESISTOR,FXD, CMPSN, 1K, 5%, 1/8W (V81349) 745-1863-490 A6R34		1
114	RCR05G331JS	3	RESISTOR,FXD, CMPSN, 330 OHMS, 5%, 1/8W (V81349) 745-1863-370 A6R16		1
115	1N5767	3	SEMICONV DEVICE, (V07688) 922-6119-010 A6CR7		1
116	RCR05G221JS	3	RESISTOR,FXD, CMPSN, 220 OHMS, 5%, 1/8W (V81349) 745-1863-330 A6R17		1
117	240-2711-300	3	COIL,RF, 27UH (V99800) 240-2711-300 A6L9		1
118	240-2711-300	3	COIL,RF, 27UH (V99800) 240-2711-300 A6L16		1
119	2482-010W5T102AA	3	CAPACITOR,FXD, CER DIEI, 1000PF, GMV, 150V (V72982) 913-4491-100 A6C18		1
120	2482-010W5T102AA	3	CAPACITOR,FXD, CER DIEI, 1000PF, GMV, 150V (V72982) 913-4491-100 A6C42		1
121	2482-010W5T102AA	3	CAPACITOR,FXD, CER DIEI, 1000PF, GMV, 150V (V72982) 913-4491-100 (SPARE)		1
122	RCR05G100JS	3	RESISTOR,FXD, CMPSN, 10 OHMS, 5%, 1/8W (V81349) 745-1863-010 A6R10		1
123	240-2711-300	3	COIL,RF, 27UH (V99800) 240-2711-300 A6L6		1
124	RCR05G682JS	3	RESISTOR,FXD, CMPSN, 6.8K, 5%, 1/8W (V81349) 745-1863-690 A6R11		1
125	RCR05G152JS	3	RESISTOR,FXD, CMPSN, 1.5K, 5%, 1/8W (V81349) 745-1863-530 A6R33		1
126	MS75085-03	3	COIL,RF, 47UH (V96906) 240-2043-000 A6L5		1
127	C22A103K	3	CAPACITOR,FXD, CER DIEI, 10,000PF, 10%, 100V (V16546) 913-5661-120 A6C14		1
128	8111B079C0G0-828 C	3	CAPACITOR,FXD, CER DIEI, 0.82PF, 0.25PF, 75V (V72982) 913-1098-290 A6C21		1
129	MS75085-03	3	COIL,RF, 47UH (V96906) 240-2043-000 A6L7		1
130	2C067103X0101A3	3	CAPACITOR,FXD, CER DIEI, 0.01UF, 20%, 100V (V56289) 913-4240-100 A6C43		1
131	RCR05G100JS	3	RESISTOR,FXD, CMPSN, 10 OHMS, 5%, 1/8W (V81349) 745-1863-010 A6R14		1
132	DM5F171J050WV	3	CAPACITOR,FXD, MICA DIEI, 170PF, 5%, 50V (V72136) 912-4141-420 A6C22		1
133	C22A103K	3	CAPACITOR,FXD, CER DIEI, 10,000PF, 10%, 100V (V16546) 913-5661-120 A6C23		1
134	2C067104X0101A3	3	CAPACITOR,FXD, CER DIEI, 0.1UF, 20%, 100V (V56289) 913-4240-040 A6C19		1
135	790-0266-001	3	DIODE,ZENER, A6Z1		1
136	790-0266-001	3	DIODE,ZENER, A6Z2		1
137	RCR05G101JS	3	RESISTOR,FXD, CMPSN, 100 OHMS, 5%, 1/8W (V81349) 745-1863-250 A6R5		1
138	1N5767	3	SEMICONV DEVICE, (V07688) 922-6119-010 A6CR4		1
139	RCR05G332JS	3	RESISTOR,FXD, CMPSN, 3.3K, 5%, 1/8W (V81349) 745-1863-610 A6R6		1
140	RCR07G680KS	3	RESISTOR,FXD, CMPSN, 68 OHMS, 10%, 1/4W (V81349) 745-0707-000 A6R4		1
141	240-2711-300	3	COIL,RF, 27UH (V99800) 240-2711-300 A6L13		1
142	3329H1-502	3	RESISTOR,VAR, 5K, 20%, 0.5W (V80294) 382-0027-090 A6R31		1
143	2482-010W5T102AA	3	CAPACITOR,FXD, CER DIEI, 1000PF, GMV, 150V (V72982) 913-4491-100 A6C10		1

## GROUP ASSEMBLY PARTS LIST

FIG - ITEM	PART NO	INDENT	DESCRIPTION	USABLE ON CODE	UNITS PER ASSY
16 144	2482-010W5T102AA	3	CAPACITOR,FXD, CER DIEL, 1000PF, GMV, 150V (V72982) 913-4491-100 A6C3		1
145	2482-010W5T102AA	3	CAPACITOR,FXD, CER DIEL, 1000PF, GMV, 150V (V72982) 913-4491-100 A6C1		1
146	2482-010W5T102AA	3	CAPACITOR,FXD, CER DIEL, 1000PF, GMV, 150V (V72982) 913-4491-100 A6C9		1
147	A260	3	TRANSFORMER,RF, (V81815) 278-0375-010 A6T1		1
148	790-0259-001	3	TRANSFORMER, A6T2		1
149	790-0260-001	3	TRANSFORMER, A6T3		1
150	A217	3	TRANSFORMER,RF, (V81815) 278-0350-010 A6T4		1
151	A216	3	TRANSFORMER,RF, (V81815) 278-0349-010 A6T5		1
152	A296	3	TRAP CKT,SERIES, (V81815) 278-0401-010 A6T6		1
153	140-0530-9014	3	CABLE ASSY,ELEC, (V98278) 426-5435-270 A6P6 A6P9,A6P10		3
154	RG178BU	3	CABLE,RF, (V81349) 425-1538-000		AR
155	2C067102X0101A3	3	CAPACITOR,FXD, CER DIEL, 0.001UF, 20%, 100V (V56289) 913-4240-140 A6C27		1
156	5082-8907	3	SEMICOND DEVICE, (V28480) 353-3691-010 A6CR8		1
157	C22A102M	3	CAPACITOR,FXD, CER DIEL, 1000PF, 20%, 100V (V16546) 913-5661-710 A6C28		1
158	240-2711-170	3	COIL,RF, 2.20UH (V99800) 240-2711-170 A6L10		1
159	1N746A	3	SEMICOND DEVICE, (V07688) 353-2938-000 A6VR9		1
160	C22A102M	3	CAPACITOR,FXD, CER DIEL, 1000PF, 20%, 100V (V16546) 913-5661-710 A6C30		1
161	C22A102M	3	CAPACITOR,FXD, CER DIEL, 1000PF, 20%, 100V (V16546) 913-5661-710 A6C29		1
162	DM5F151J050WV	3	CAPACITOR,FXD, MICA DIEL, 150PF, 5%, 50V (V72136) 912-4141-400 A6C34		1
163	T055-3320-1F	3	RESISTOR,FXD, FILM, 332 OHMS, 1%, 1/8W (V11502) 705-1470-500 A6R23		1
164	RCR05G4R7KS	3	RESISTOR, FXD, CMPSN, 4.7 OHMS, 10%, 1/8W (V81349) 745-0907-340 A6R32		1
165	C22A102M	3	CAPACITOR,FXD, CER DIEL, 1000PF, 20%, 100V (V16546) 913-5661-710 A6C32		1
166	RCR07G152KS	3	RESISTOR,FXD, CMPSN, 1.5K, 10%, 1/4W (V81349) 745-0755-000 A6R22		1
167	1N5767	3	SEMICOND DEVICE, (V07688) 352-6119-010 A6CR10		1
168	C22A102M	3	CAPACITOR,FXD, CER DIEL, 1000PF, 20%, 100V (V16546) 913-5661-710 A6C31		1
169	55D22R1F	3	RESISTOR,FXD, FILM, 22.1 OHMS, 1%, 1/8W (V96214) 705-1469-160 A6R21		1
170	MS75083-09	3	COIL,RF, 0.47UH (V96906) 240-2019-000 A6L12		1
171	RCR05G100JS	3	RESISTOR,FXD, CMPSN, 10 OHMS, 5%, 1/8W (V81349) 745-1863-010 A6R19		1
172	C22A102M	3	CAPACITOR,FXD, CER DIEL, 1000PF, 20%, 100V (V16546) 913-5661-710 A6C26		1
173	T055-3010-1F	3	RESISTOR,FXD, FILM, 301 OHMS, 1%, 1/8W (V11502) 705-1470-490 A6R18		1
174	DM5F151J050WV	3	CAPACITOR,FXD, MICA DIEL, 150PF, 5%, 50V (V72136) 912-4141-400 A6C24		1
175	M39003-01-2029	3	CAPACITOR,FXD, ELCTLT, 3.3UF, 20%, 15V (V81349) 184-9083-290 A6C25		1
176	240-2711-170	3	COIL,RF, 2.20UH (V99800) 240-2711-170 A6L11		1
177	2N5109	3	TRANSISTOR, (V07688) 352-0766-010 A6Q5		1
178	T1579	3	INSULATOR,XSTR, (V98291) 352-9800-010		1
179	4005	3	INSULATOR,DISK, (V13103) 352-9582-030		1
180	2N2222A	3	TRANSISTOR, (V81350) 352-7500-280 A6Q4		1
181	T1533	3	HOLDER,XSTR, (V98291) 352-9509-000		1
182	2482-010W5T102AA	3	CAPACITOR,FXD, CER DIEL, 1000PF, GMV, 150V (V72982) 913-4491-100 A6C33		1
183	609-1653-001	3	SHIELD, NO 2		1
	68-1660-26	3	NUT,SLFLKG,HEX, AL, 2-56 (V72962) 333-0604-000 (AP)		2

GROUP ASSEMBLY PARTS LIST

FIG - ITEM	PART NO	INDENT	DESCRIPTION	USABLE ON CODE	UNITS PER ASSY
16	MS51957-3	3	SCREW, MACH, CD PL STL, 2-56 X 1/4 (V96906) 343-0124-000 (AP)		2
184	3PP4-66A	4	TERMINAL, FEEDTH, (V86577) 306-0953-000		1
185	12914A	4	TERMINAL, STUD, (V88245) 306-0983-000		4
186	SL582-519WHT	4	TERMINAL, FEEDTH, (V12615) 306-2223-120		2
187	SL481-491WHT	4	TERMINAL, STUD, (V12615) 306-2511-100		8
188	609-0945-001	4	SHIELD, NO 2		1
189	DM5F151J050NV	3	CAPACITOR, FXD, MICA DIEI, 150PF, 5%, 50V (V72136) 912-4141-400 A6C38		1
190	T055-3010-1F	3	RESISTOR, FXD, FILM, 301 OHMS, 1%, 1/8W (V11502) 705-1470-490 A6R29		1
191	T055-2-87K1F	3	RESISTOR, FXD, FILM, 2.87K, 1%, 1/8W (V11502) 705-1454-500 A6R28		1
192	2C067102X0101A3	3	CAPACITOR, FXD, CER DIEI, 0.001UF, 20%, 100V (V56289) 913-4240-140 A6C40		1
193	55D1820F	3	RESISTOR, FXD, FILM, 182 OHMS, 1%, 1/8W (V96214) 705-1469-590 A6R30		1
194	240-2711-170	3	COIL, RF, 2.20UH (V99800) 240-2711-170 A6L14		1
195	RCR05G331JS	3	RESISTOR, FXD, CMPSN, 330 OHMS, 5%, 1/8W (V81349) 745-1863-370 A6R25		1
196	C22A102M	3	CAPACITOR, FXD, CER DIEI, 1000PF, 20%, 100V (V16546) 913-5661-710 A6C37		1
197	T055-1K1F	3	RESISTOR, FXD, FILM, 1K, 1%, 1/8W (V11502) 705-1454-390 A6R24		1
198	DM5F151J050WV	3	CAPACITOR, FXD, MICA DIEI, 150PF, 5%, 50V (V72136) 912-4141-400 A6C35		1
199	M39003-01-2029	3	CAPACITOR, FXD, ELCTLT, 3.3UF, 20%, 15V (V81349) 184-9083-290 A6C36		1
200	MS75083-09	3	COIL, RF, 0.47UH (V96906) 240-2019-000 A6L15		1
201	RCR05G680JS	3	RESISTOR, FXD, CMPSN, 68 OHMS, 5%, 1/8W (V81349) 745-1863-210 A6R26		1
202	T055-27R4-1F	3	RESISTOR, FXD, FILM, 27.4 OHMS, 1%, 1/8W (V11502) 705-1470-220 A6R27		1
203	2N5109	3	TRANSISTOR, (V07688) 352-0766-010 A606		1
204	T1579	3	INSULATOR, XSTR, (V98291) 352-9800-010		1
205	4005	3	INSULATOR, DISK, (V13103) 352-9582-030		1
206	2482-010W5T102AA	3	CAPACITOR, FXD, CER DIEI, 1000PF, GMV, 150V (V72982) 913-4491-100 A6C39		1
207	609-1652-001	3	SHIELD, NO 1		1
	68-1660-26	3	NUT, SLFLKG, HEX, AL, 2-56 (V72962) 333-0604-000 (AP)		2
	MS51957-3	3	SCREW, MACH, CD PL STL, 2-56 X 1/4 (V96906) 343-0124-000 (AP)		2
208	12914A	4	TERMINAL, STUD, (V88245) 306-0983-000		4
209	SL582-519WHT	4	TERMINAL, FEEDTH, (V12615) 306-2223-120		1
210	SL481-491WHT	4	TERMINAL, STUD, (V12615) 306-2511-100		8
211	609-0938-001	4	SHIELD, NO 1		1
212	609-1562-001	3	CHASSIS, MIXER		1
213	885170	4	TERMINAL, FEEDTH, (V86577) 306-0989-000		10
214	SL582-519WHT	4	TERMINAL, FEEDTH, (V12615) 306-2223-120		28
215	011-6809	4	TERMINAL, FEEDTH, (V98291) 306-2297-000		4
216	SL481-491WHT	4	TERMINAL, STUD, (V12615) 306-2511-100		9
217	R22NCPMA1-26	4	NUT, SLFLKG, CD PL STL, 2-56 (V72962) 333-0837-000		4
218	790-2483-001	4	CHASSIS, MIXER		1
219	790-1358-001	2	PLATE, CONN MTG		1
	MS51957-13	2	SCREW, MACH, STL, 4-40 X 1/4 (V96906) 343-0133-000 (AP)		3
	MS35338-135	2	WASHER, LOCK, SST, 0.115 ID X 0.209 OD (V96906) 310-0279-000 (AP)		3
	4007-4HT	2	TERMINAL, LUG, (V77147) 304-0015-000 (AP)		1
220	MS90537-41	2	COIL, RF, 220UH (V96906) 240-2715-410 A6L303		1
221	MS90537-41	2	COIL, RF, 220UH (V96906) 240-2715-410 A6L304		1

## GROUP ASSEMBLY PARTS LIST

FIG - ITEM	PART NO	INDENT	DESCRIPTION	USABLE ON CODE	UNITS PER ASSY
16 222	372-2255-020	2	CONTACT,ELEC, 372-2255-020		3
223	790-1378-001	2	HOUSING,CONN, A6P7A		1
224	790-1367-001	2	SHIM		2
225	790-1378-002	2	HOUSING,CONN, A6P7B		1
	68-1660-26	2	NUT,SLFLKG,HEX, AL, 2-56 (V72962) 333-0604-000 (AP FOR 223-225)		2
	MS51957-10	2	SCREW,MACH, SST, 2-56 X 7/8 (V96906)	R	2
			343-0130-000 (AP FOR 223-225)		
	P342-0149-000	2	SCREW,MACH, NP BRS, 2-56 X 7/8 (V77250)	S	2
			342-0149-000 (AP FOR 223-225)		
226	606-9879-002	2	FILTER,NETWORK	R	1
226	606-9879-003	2	FILTER,NETWORK	S	1
	68-1660-26	2	NUT,SLFLKG,HEX, AL, 2-56 (V72962) 333-0604-000 (AP)		2
	MS51959-3	2	SCREW,MACH, SST, 2-56 X 1/4 (V96906)		2
			342-0133-000 (AP)		
227	MS90538-06	3	COIL,RF, 56UH (V96906) 240-2510-000 A6L301		1
228	MS90538-06	3	COIL,RF, 56UH (V96906) 240-2510-000 A6L302		1
229	MS90538-06	3	COIL,RF, 56UH (V96906) 240-2510-000 A6L305	S	1
230	2465-009W5T0102P	3	CAPACITOR,FXD, CER DIEI, 1000PF, GMV, 500V (V72982) 913-3209-000 A6C301		1
231	2465-009W5T0102P	3	CAPACITOR,FXD, CER DIEI, 1000PF, GMV, 500V (V72982) 913-3209-000 A6C303		1
232	2465-009W5T0102P	3	CAPACITOR,FXD, CER DIEI, 1000PF, GMV, 500V (V72982) 913-3209-000 A6C302		1
233	2465-009W5T0102P	3	CAPACITOR,FXD, CER DIEI, 1000PF, GMV, 500V (V72982) 913-3209-000 A6C304		1
234	2465-009W5T0102P	3	CAPACITOR,FXD, CER DIEI, 1000PF, GMV, 500V (V72982) 913-3209-000 A6C305	S	1
235	2465-009W5T0102P	3	CAPACITOR,FXD, CER DIEI, 1000PF, GMV, 500V (V72982) 913-3209-000 A6C306	S	1
236	609-1560-001	3	BRACKET, FILTER		1
237	790-1357-001	2	PLATE,CONN MTG		1
	MS51957-13	2	SCREW,MACH, STL, 4-40 X 1/4 (V96906)		2
			343-0133-000 (AP)		
	MS35338-135	2	WASHER,LOCK, SST, 0.115 ID X 0.209 OD (V96906)		2
			310-0279-000 (AP)		
238	609-1570-002	2	POST	S	4
	MS51959-3	2	SCREW,MACH, SST, 2-56 X 1/4 (V96906)	S	4
			342-0133-000 (AP)		
239	790-1402-001	2	SHEET, INSULATION		1
240	790-1401-001	2	SHEET, INSULATION		1
241	609-1631-001	2	CHASSIS		1
242	790-1472-001	3	CONTACT STRIP, GROUNDING		1
	SE23CDPL	3	EYELET,MTLC, CD PL BRS, 0.062 DIA X 0.092 (V90030) 307-1052-000 (AP)		5
243	546-6127-002	3	HANDLE		1
244	546-6126-002	3	RETAINER,HANDLE		1
	R4008X1-8CHROMAT	3	RIVET,TUBULAR, AL, 0.089 DIA X 1/8 (V12014)		2
	EDP		305-0170-000 (AP)		
245	SL441-434WHT	3	TERMINAL,STUD, (V12615) 306-2222-100		2
246	SL354-351WHT	3	TERMINAL,FEEDTH, (V12615) 306-2474-010		2
247	609-1544-001	3	POST		2
248	609-1545-001	3	POST		3
249	609-1545-002	3	POST		5
250	609-1638-001	3	FASTENER		18
251	609-1546-001	3	CHASSIS		1

GROUP ASSEMBLY PARTS LIST

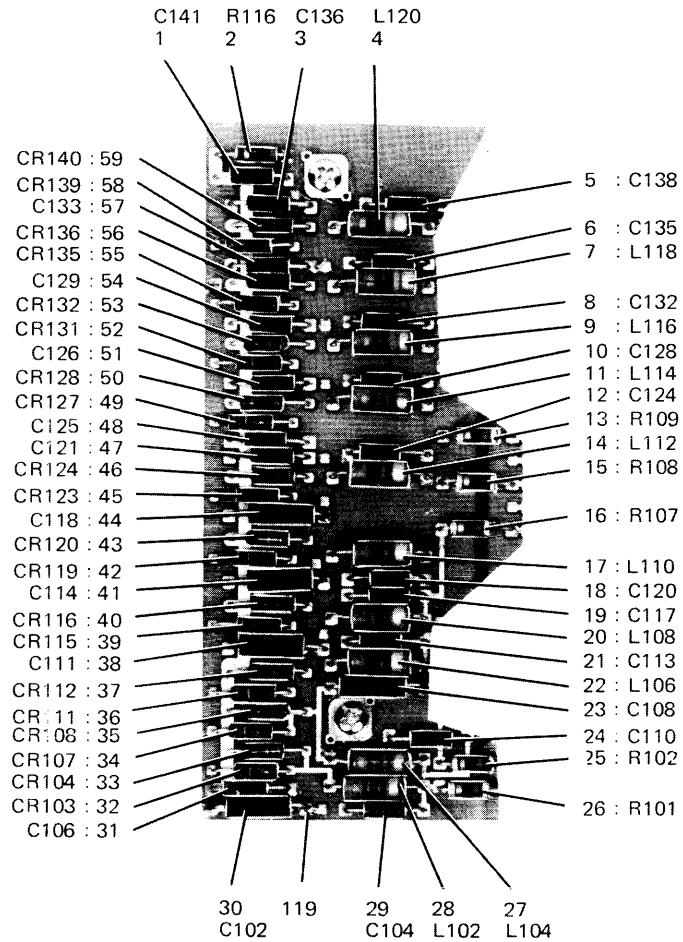

TP3-1032-027

Diode Switching Circuit Card Assembly (P/o A6) 778-2934-002, -003  
Figure 17 (Sheet 1 of 2)

GROUP ASSEMBLY PARTS LIST

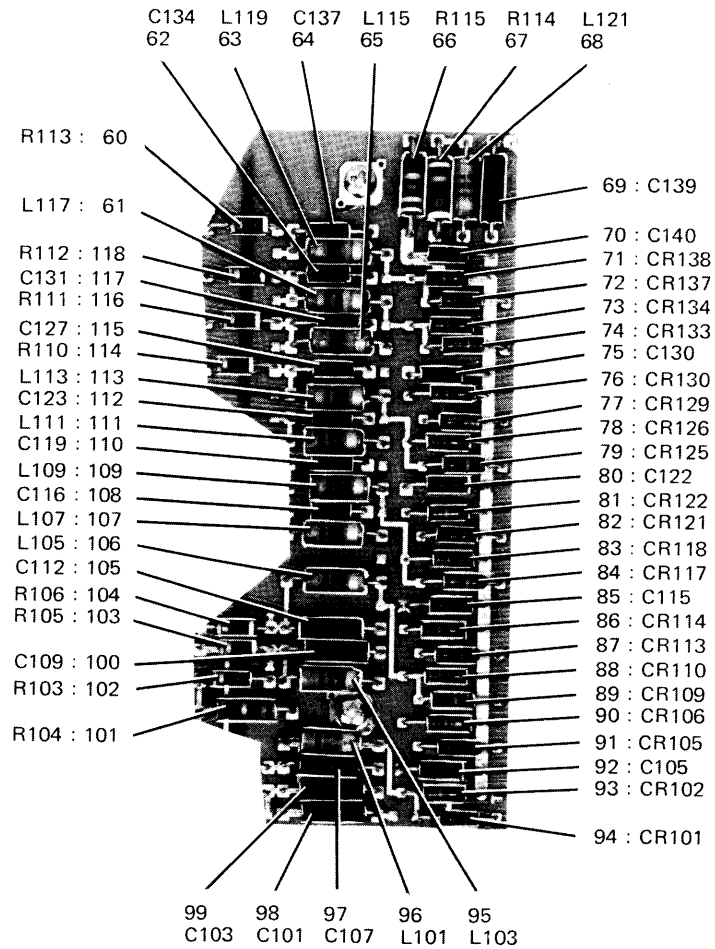

TP3-1032-027

Diode Switching Circuit Card Assembly (P/o A6) 778-2934-002, -003  
Figure 17 (Sheet 2 of 2)

## GROUP ASSEMBLY PARTS LIST

FIG - ITEM	PART NO	INDENT	DESCRIPTION	USABLE ON CODE	UNITS PER ASSY
17	778-2934-002	1	CIRCUIT CARD ASSY, DIODE SWITCHING (SEE FIG 16-3 FOR NHA)	T	RF
"	778-2934-003	1	CIRCUIT CARD ASSY, DIODE SWITCHING (SEE FIG 16-3 FOR NHA)	U	RF
1	C22A103K	2	CAPACITOR,FXD, CER DIEI, 10,000PF, 10%, 100V (V16546) 913-5661-120 A6C141		1
2	RCR07G102JS	2	RESISTOR,FXD, CMPSN, 1K, 5%, 1/4W (V81349) 745-0748-000 A6R116		1
3	C22A103K	2	CAPACITOR,FXD, CER DIEI, 10,000PF, 10%, 100V (V16546) 913-5661-120 A6C136		1
4	MS90538-10	2	COIL,RF, 820H (V96906) 240-2514-000 A6L120		1
5	C22A103K	2	CAPACITOR,FXD, CER DIEI, 10,000PF, 10%, 100V (V16546) 913-5661-120 A6C138		1
6	C22A103K	2	CAPACITOR,FXD, CER DIEI, 10,000PF, 10%, 100V (V16546) 913-5661-120 A6C135		1
7	MS90538-10	2	COIL,RF, 820H (V96906) 240-2514-000 A6L118		1
8	C22A103K	2	CAPACITOR,FXD, CER DIEI, 10,000PF, 10%, 100V (V16546) 913-5661-120 A6C132		1
9	MS90538-10	2	COIL,RF, 820H (V96906) 240-2514-000 A6L116		1
10	C22A103K	2	CAPACITOR,FXD, CER DIEI, 10,000PF, 10%, 100V (V16546) 913-5661-120 A6C128		1
11	MS90538-20	2	COIL,RF, 220UH (V96906) 240-2524-000 A6L114		1
12	C22A103K	2	CAPACITOR,FXD, CER DIEI, 10,000PF, 10%, 100V (V16546) 913-5661-120 A6C124		1
13	RCR07G910JS	2	RESISTOR,FXD, CMPSN, 91 OHMS, 5%, 1/4W (V81349) 745-0711-000 A6R109		1
14	MS90538-20	2	COIL,RF, 220UH (V96906) 240-2524-000 A6L112		1
15	RCR07G910JS	2	RESISTOR,FXD, CMPSN, 91 OHMS, 5%, 1/4W (V81349) 745-0711-000 A6R108		1
16	RCR07G910JS	2	RESISTOR,FXD, CMPSN, 91 OHMS, 5%, 1/4W (V81349) 745-0711-000 A6R107		1
17	MS90538-20	2	COIL,RF, 220UH (V96906) 240-2524-000 A6L110		1
18	C22A103K	2	CAPACITOR,FXD, CER DIEI, 10,000PF, 10%, 100V (V16546) 913-5661-120 A6C120		1
19	C22A103K	2	CAPACITOR,FXD, CER DIEI, 10,000PF, 10%, 100V (V16546) 913-5661-120 A6C117		1
20	MS90538-20	2	COIL,RF, 220UH (V96906) 240-2524-000 A6L108		1
21	C22A103K	2	CAPACITOR,FXD, CER DIEI, 10,000PF, 10%, 100V (V16546) 913-5661-120 A6C113		1
22	MS90538-20	2	COIL,RF, 220UH (V96906) 240-2524-000 A6L106		1
23	C22C104M	2	CAPACITOR,FXD, CER DIEI, 100,000PF, 20%, 50V (V16546) 913-5661-240 A6C108		1
24	C22A103K	2	CAPACITOR,FXD, CER DIEI, 10,000PF, 10%, 100V (V16546) 913-5661-120 A6C110		1
25	RCR07G180JS	2	RESISTOR,FXD, CMPSN, 18 OHMS, 5%, 1/4W (V81349) 745-0685-000 A6R102		1
26	RCR07G910JS	2	RESISTOR,FXD, CMPSN, 91 OHMS, 5%, 1/4W (V81349) 745-0711-000 A6R101		1
27	MS90538-20	2	COIL,RF, 220UH (V96906) 240-2524-000 A6L104		1
28	MS90538-20	2	COIL,RF, 220UH (V96906) 240-2524-000 A6L102		1
29	C22A103K	2	CAPACITOR,FXD, CER DIEI, 10,000PF, 10%, 100V (V16546) 913-5661-120 A6C104		1
30	C22C104M	2	CAPACITOR,FXD, CER DIEI, 100,000PF, 20%, 50V (V16546) 913-5661-240 A6C102		1
31	C22A103K	2	CAPACITOR,FXD, CER DIEI, 10,000PF, 10%, 100V (V16546) 913-5661-120 A6C106		1
32	1N458	2	SEMICONV DEVICE, (V07688) 353-0205-000 A6CR103		1
33	1N458	2	SEMICONV DEVICE, (V07688) 353-0205-000 A6CR104		1
34	1N458	2	SEMICONV DEVICE, (V07688) 353-0205-000 A6CR107		1
35	1N458	2	SEMICONV DEVICE, (V07688) 353-0205-000 A6CR108		1
36	1N458	2	SEMICONV DEVICE, (V07688) 353-0205-000 A6CR111		1
37	1N458	2	SEMICONV DEVICE, (V07688) 353-0205-000 A6CR112		1

## GROUP ASSEMBLY PARTS LIST

FIG - ITEM	PART NO	INDENT	DESCRIPTION	USABLE ON CODE	UNITS PER ASSY
17 38	C22C104M	2	CAPACITOR,FXD, CER DIEI, 100,000PF, 20%, 50V (V16546) 913-5661-240 A6C111		1
39	1N458	2	SEMICON D DEVICE, (V07688) 353-0205-000 A6CR115		1
40	1N458	2	SEMICON D DEVICE, (V07688) 353-0205-000 A6CR116		1
41	C22C104M	2	CAPACITOR,FXD, CER DIEI, 100,000PF, 20%, 50V (V16546) 913-5661-240 A6C114		1
42	1N458	2	SEMICON D DEVICE, (V07688) 353-0205-000 A6CR119		1
43	1N458	2	SEMICON D DEVICE, (V07688) 353-0205-000 A6CR120		1
44	C22C104M	2	CAPACITOR,FXD, CER DIEI, 100,000PF, 20%, 50V (V16546) 913-5661-240 A6C118		1
45	1N458	2	SEMICON D DEVICE, (V07688) 353-0205-000 A6CR123		1
46	1N458	2	SEMICON D DEVICE, (V07688) 353-0205-000 A6CR124		1
47	C22A103K	2	CAPACITOR,FXD, CER DIEI, 10,000PF, 10%, 100V (V16546) 913-5661-120 A6C121		1
48	C22A103K	2	CAPACITOR,FXD, CER DIEI, 10,000PF, 10%, 100V (V16546) 913-5661-120 A6C125		1
49	1N458	2	SEMICON D DEVICE, (V07688) 353-0205-000 A6CR127		1
50	1N458	2	SEMICON D DEVICE, (V07688) 353-0205-000 A6CR128		1
51	C22A103K	2	CAPACITOR,FXD, CER DIEI, 10,000PF, 10%, 100V (V16546) 913-5661-120 A6C126		1
52	1N458	2	SEMICON D DEVICE, (V07688) 353-0205-000 A6CR131		1
53	1N458	2	SEMICON D DEVICE, (V07688) 353-0205-000 A6CR132		1
54	C22A103K	2	CAPACITOR,FXD, CER DIEI, 10,000PF, 10%, 100V (V16546) 913-5661-120 A6C129		1
55	1N458	2	SEMICON D DEVICE, (V07688) 353-0205-000 A6CR135		1
56	1N458	2	SEMICON D DEVICE, (V07688) 353-0205-000 A6CR136		1
57	C22A103K	2	CAPACITOR,FXD, CER DIEI, 10,000PF, 10%, 100V (V16546) 913-5661-120 A6C133		1
58	1N458	2	SEMICON D DEVICE, (V07688) 353-0205-000 A6CR139		1
59	1N458	2	SEMICON D DEVICE, (V07688) 353-0205-000 A6CR140		1
60	RCR07G910JS	2	RESISTOR,FXD, CMPSN, 91 OHMS, 5%, 1/4W (V81349) 745-0711-000 A6R113		1
61	MS90538-10	2	COIL,RF, 82UH (V96906) 240-2514-000 A6L117		1
62	C22A103K	2	CAPACITOR,FXD, CER DIEI, 10,000PF, 10%, 100V (V16546) 913-5661-120 A6C134		1
63	MS90538-10	2	COIL,RF, 82UH (V96906) 240-2514-000 A6L119		1
64	C22A103K	2	CAPACITOR,FXD, CER DIEI, 10,000PF, 10%, 100V (V16546) 913-5661-120 A6C137		1
65	MS90538-10	2	COIL,RF, 82UH (V96906) 240-2514-000 A6L115		1
66	RCR20G431JS	2	RESISTOR,FXD, CMPSN, 430 OHMS, 5%, 1/2W (V81349) 745-1336-000 A6R115		1
67	RCR20G910JS	2	RESISTOR,FXD, CMPSN, 91 OHMS, 5%, 1/2W (V81349) 745-1308-000 A6R114		1
68	MS90538-20	2	COIL,RF, 220UH (V96906) 240-2524-000 A6L121		1
69	C22C104M	2	CAPACITOR,FXD, CER DIEI, 100,000PF, 20%, 50V (V16546) 913-5661-240 A6C139		1
70	C22A103K	2	CAPACITOR,FXD, CER DIEI, 10,000PF, 10%, 100V (V16546) 913-5661-120 A6C140		1
71	1N458	2	SEMICON D DEVICE, (V07688) 353-0205-000 A6CR138		1
72	1N458	2	SEMICON D DEVICE, (V07688) 353-0205-000 A6CR137		1
73	1N458	2	SEMICON D DEVICE, (V07688) 353-0205-000 A6CR134		1
74	1N458	2	SEMICON D DEVICE, (V07688) 353-0205-000 A6CR133		1
75	C22A103K	2	CAPACITOR,FXD, CER DIEI, 10,000PF, 10%, 100V (V16546) 913-5661-120 A6C130		1
76	1N458	2	SEMICON D DEVICE, (V07688) 353-0205-000 A6CR130		1
77	1N458	2	SEMICON D DEVICE, (V07688) 353-0205-000 A6CR129		1
78	1N458	2	SEMICON D DEVICE, (V07688) 353-0205-000 A6CR126		1
79	1N458	2	SEMICON D DEVICE, (V07688) 353-0205-000 A6CR125		1
80	C22A103K	2	CAPACITOR,FXD, CER DIEI, 10,000PF, 10%, 100V (V16546) 913-5661-120 A6C122		1
81	1N458	2	SEMICON D DEVICE, (V07688) 353-0205-000 A6CR122		1
82	1N458	2	SEMICON D DEVICE, (V07688) 353-0205-000 A6CR121		1
83	1N458	2	SEMICON D DEVICE, (V07688) 353-0205-000 A6CR118		1



## GROUP ASSEMBLY PARTS LIST

FIG - ITEM	PART NO	INDENT	DESCRIPTION	USABLE ON CODE	UNITS PER ASSY
17	84	1N458	2 SEMICONV DEVICE, (V07688) 353-0205-000 A6CR117		1
	85	C22A103K	2 CAPACITOR,FXD, CER DIEI, 10,000PF, 10%, 100V (V16546) 913-5661-120 A6C115		1
	86	1N458	2 SEMICONV DEVICE, (V07688) 353-0205-000 A6CR114		1
	87	1N458	2 SEMICONV DEVICE, (V07688) 353-0205-000 A6CR113		1
	88	1N458	2 SEMICONV DEVICE, (V07688) 353-0205-000 A6CR110		1
	89	1N458	2 SEMICONV DEVICE, (V07688) 353-0205-000 A6CR109		1
	90	1N458	2 SEMICONV DEVICE, (V07688) 353-0205-000 A6CR106		1
	91	1N458	2 SEMICONV DEVICE, (V07688) 353-0205-000 A6CR105		1
	92	C22A103K	2 CAPACITOR,FXD, CER DIEI, 10,000PF, 10%, 100V (V16546) 913-5661-120 A6C105		1
	93	1N458	2 SEMICONV DEVICE, (V07688) 353-0205-000 A6CR102	T	1
	94	1N458	2 SEMICONV DEVICE, (V07688) 353-0205-000 A6CR101	T	1
	95	MS90538-20	2 COIL,RF, 220UH (V96906) 240-2524-000 A6L103		1
	96	MS90538-20	2 COIL,RF, 220UH (V96906) 240-2524-000 A6L101	T	1
	97	C22C104M	2 CAPACITOR,FXD, CER DIEI, 100,000PF, 20%, 50V (V16546) 913-5661-240 A6C107		1
	98	C22C104M	2 CAPACITOR,FXD, CER DIEI, 100,000PF, 20%, 50V (V16546) 913-5661-240 A6C101	T	1
	99	C22C104M	2 CAPACITOR,FXD, CER DIEI, 100,000PF, 20%, 50V (V16546) 913-5661-240 A6C103		1
	100	C22C104M	2 CAPACITOR,FXD, CER DIEI, 100,000PF, 20%, 50V (V16546) 913-5661-240 A6C109		1
	101	RCR20G680JS	2 RESISTOR,FXD, CMPSN, 68 OHMS, 5%, 1/2W (V81349) 745-1302-000 A6R104		1
	102	RCR07G180JS	2 RESISTOR,FXD, CMPSN, 18 OHMS, 5%, 1/4W (V81349) 745-0685-000 A6R103		1
	103	RCR07G910JS	2 RESISTOR,FXD, CMPSN, 91 OHMS, 5%, 1/4W (V81349) 745-0711-000 A6R105		1
	104	RCR07G910JS	2 RESISTOR,FXD, CMPSN, 91 OHMS, 5%, 1/4W (V81349) 745-0711-000 A6R106		1
	105	C22C104M	2 CAPACITOR,FXD, CER DIEI, 100,000PF, 20%, 50V (V16546) 913-5661-240 A6C112		1
	106	MS90538-20	2 COIL,RF, 220UH (V96906) 240-2524-000 A6L105		1
	107	MS90538-20	2 COIL,RF, 220UH (V96906) 240-2524-000 A6L107		1
	108	C22A103K	2 CAPACITOR,FXD, CER DIEI, 10,000PF, 10%, 100V (V16546) 913-5661-120 A6C116		1
	109	MS90538-20	2 COIL,RF, 220UH (V96906) 240-2524-000 A6L109		1
	110	C22A103K	2 CAPACITOR,FXD, CER DIEI, 10,000PF, 10%, 100V (V16546) 913-5661-120 A6C119		1
	111	MS90538-20	2 COIL,RF, 220UH (V96906) 240-2524-000 A6L111		1
	112	C22A103K	2 CAPACITOR,FXD, CER DIEI, 10,000PF, 10%, 100V (V16546) 913-5661-120 A6C123		1
	113	MS90538-20	2 COIL,RF, 220UH (V96906) 240-2524-000 A6L113		1
	114	RCR07G910JS	2 RESISTOR,FXD, CMPSN, 91 OHMS, 5%, 1/4W (V81349) 745-0711-000 A6R110		1
	115	C22A103K	2 CAPACITOR,FXD, CER DIEI, 10,000PF, 10%, 100V (V16546) 913-5661-120 A6C127		1
	116	RCR07G910JS	2 RESISTOR,FXD, CMPSN, 91 OHMS, 5%, 1/4W (V81349) 745-0711-000 A6R111		1
	117	C22A103K	2 CAPACITOR,FXD, CER DIEI, 10,000PF, 10%, 100V (V16546) 913-5661-120 A6C131		1
	118	RCR07G910JS	2 RESISTOR,FXD, CMPSN, 91 OHMS, 5%, 1/4W (V81349) 745-0711-000 A6R112		1
	119	372-2601-010	2 CONTACT,ELEC, 372-2601-010		28

GROUP ASSEMBLY PARTS LIST

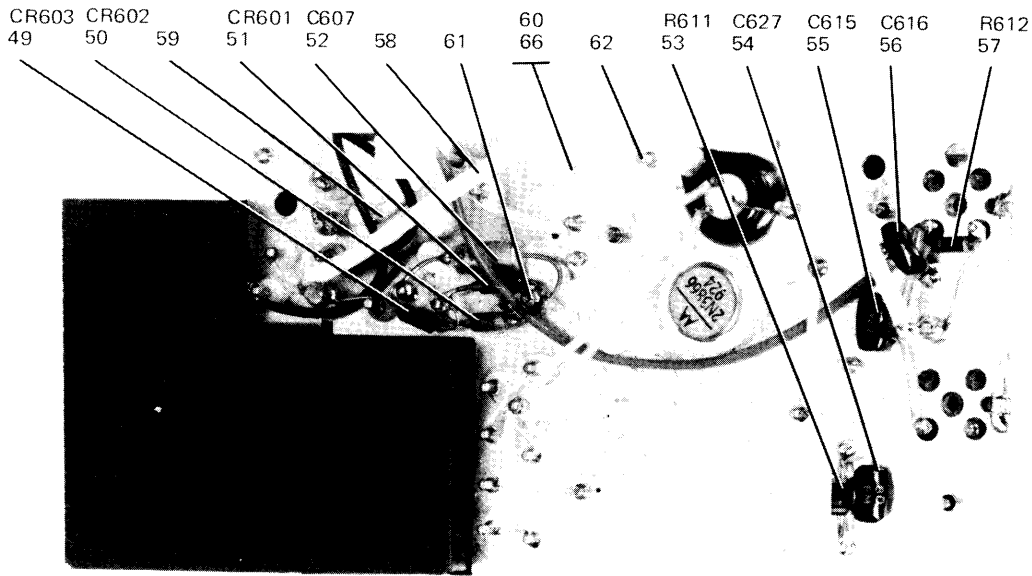
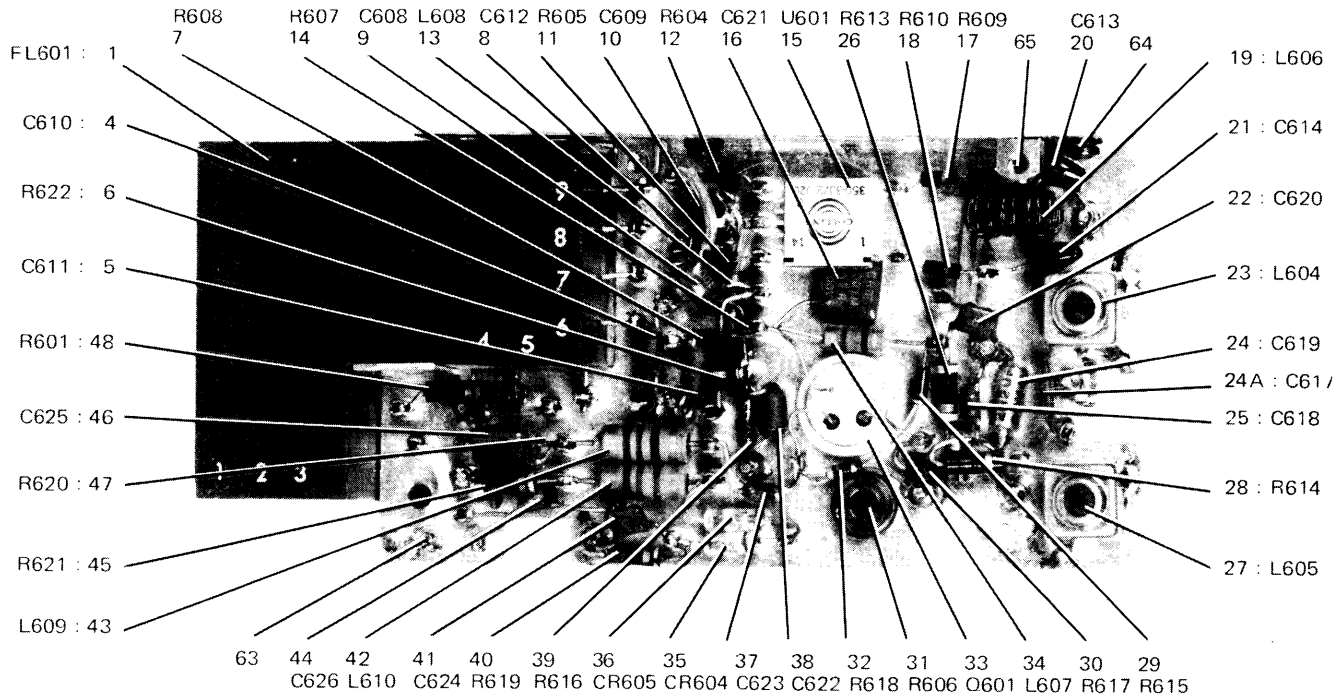

TP3-1033-017

VLF Mixer (P/o A6) 609-1643-001  
Figure 18

## GROUP ASSEMBLY PARTS LIST

FIG - ITEM	PART NO	INDENT	DESCRIPTION	USABLE ON CODE	UNITS PER ASSY
18 -	609-1643-001	1	MIXER, VLF, (SEE FIG 16-82,36-19A FOR NHA)	S	RF
1	609-1651-001	2	FILTER, RF, A6FL601 (EFF TO CI 72263)		1
1	609-1557-001	2	FILTER, RF, A6FL601 (EFF CI 72263)		1
	MS51959-11	2	SCREW, MACH, SST, 4-40 X 1/8 (V96906)		3
			342-0042-000 (AP)		
			(NOT USED)		
2			(NOT USED)		
3			(NOT USED)		
4	2C067104X0101A3	2	CAPACITOR, FXD, CER DIEI, 0.1UF, 20%, 100V (V56289) 913-4240-040 A6C610		1
5	2C067104X0101A3	2	CAPACITOR, FXD, CER DIEI, 0.1UF, 20%, 100V (V56289) 913-4240-040 A6C611		1
6	RCR07G102JS	2	RESISTOR, FXD, CMPSN, 1K, 5%, 1/4W (V81349)		1
			745-0748-000 A6R622		
7	RCR05G103JS	2	RESISTOR, FXD, CMPSN, 10K, 5%, 1/8W (V81349)		1
			745-1863-730 A6R608		
8	DM5E680J050WV	2	CAPACITOR, FXD, MICA DIEI, 68PF, 5%, 50V (V72136)		1
			912-4141-330 A6C612		
9	2C067103X0101A3	2	CAPACITOR, FXD, CER DIEI, 0.01UF, 20%, 100V (V56289) 913-4240-100 A6C608		1
10	DM5E680J050WV	2	CAPACITOR, FXD, MICA DIEI, 68PF, 5%, 50V (V72136)		1
			912-4141-330 A6C609		
11	RCR05G100JS	2	RESISTOR, FXD, CMPSN, 10 OHMS, 5%, 1/8W (V81349)		1
			745-1863-010 A6R605		
12	RCR05G100JS	2	RESISTOR, FXD, CMPSN, 10 OHMS, 5%, 1/8W (V81349)		1
			745-1863-010 A6R604		
13	MS75084-12	2	COIL, RF, 10UH (V96906) 240-2035-000 A6L608		1
14	RCR05G103JS	2	RESISTOR, FXD, CMPSN, 10K, 5%, 1/8W (V81349)		1
			745-1863-730 A6R607		
15	350-3072-020	2	MICROCIRCUIT, 350-3072-020 A6U601		1
16	2C067102X0101A3	2	CAPACITOR, FXD, CER DIEI, 0.001UF, 20%, 100V (V56289) 913-4240-140 A6C621		1
17	RCR05G100JS	2	RESISTOR, FXD, CMPSN, 10 OHMS, 5%, 1/8W (V81349)		1
			745-1863-010 A6R609		
18	RCR05G100JS	2	RESISTOR, FXD, CMPSN, 10 OHMS, 5%, 1/8W (V81349)		1
			745-1863-010 A6R610		
19	609-1548-001	2	COIL, RF, A6L606		1
20	DM5F101J050WV	2	CAPACITOR, FXD, MICA DIEI, 100PF, 5%, 50V (V72136) 912-4141-050 A6C613 (EFF TO CI 72314)		1
20	DM5F910J050WV	2	CAPACITOR, FXD, MICA DIEI, 91PF, 5%, 50V (V72136)		1
			912-4141-360 A6C613 (EFF CI 72314)		
21	DM5F101J050WV	2	CAPACITOR, FXD, MICA DIEI, 100PF, 5%, 50V (V72136) 912-4141-050 A6C614 (EFF TO CI 72314)		1
21	DM5F910J050WV	2	CAPACITOR, FXD, MICA DIEI, 91PF, 5%, 50V (V72136)		1
			912-4141-360 A6C614 (EFF CI 72314)		
22	2C067103X0101A3	2	CAPACITOR, FXD, CER DIEI, 0.01UF, 20%, 100V (V56289) 913-4240-100 A6C620		1
23	278-0404-010	2	COIL, RF, 4.4UH 27A-0404-010 A6L604		1
24	150D225X0020A2	2	CAPACITOR, FXD, ELCTLT, 2.2UF, 20%, 20V (V56289)		1
			184-7377-000 A6C619		
24A	D71F102J0	2	CAPACITOR, FXD, MICA DIEI, 1000PF, 5%, 100V (V00A53) 912-2093-240 A6C617		1
25	2C067103X0101A3	2	CAPACITOR, FXD, CER DIEI, 0.01UF, 20%, 100V (V56289) 913-4240-100 A6C618		1
26	RCR07G470KS	2	RESISTOR, FXD, CMPSN, 47 OHMS, 10%, 1/4W (V81349)		1
			745-0701-000 A6R613		
27	278-0404-010	2	COIL, RF, 4.4UH 27A-0404-010 A6L605		1
28	RCR07G220KS	2	RESISTOR, FXD, CMPSN, 22 OHMS, 10%, 1/4W (V81349)		1
			745-0689-000 A6R614		
29	RCR05G272JS	2	RESISTOR, FXD, CMPSN, 2.7K, 5%, 1/8W (V81349)		1
			745-1863-590 A6R615		
30	RCR07G270KS	2	RESISTOR, FXD, CMPSN, 27 OHMS, 10%, 1/4W (V81349)		1
			745-0692-000 A6R617		

GROUP ASSEMBLY PARTS LIST

FIG - ITEM	PART NO	INDENT	DESCRIPTION	USABLE ON CODE	UNITS PER ASSY
18	J1	61PNR2K	2 RESISTOR,VAR, 2K, 20%, 1/2W (V73138) 3A1-1740-080 A6R606		1
	J2	RCR05G331JS	2 RESISTOR,FXD, CMPSN, 330 OHMS, 5%, 1/8W (V81349) 745-1863-370 A6R615		1
	J3	2N5109	2 TRANSISTOR, (V07688) 352-0766-010 A6Q601 (EFF TO CI 72333)		1
	J3	352-0766-011	2 TRANSISTOR, 352-0766-011 A6Q601 (EFF CI 72333 TO CI 73053)		1
	J3	2N5109	2 TRANSISTOR, (V07688) 352-0766-010 A6Q601 (EFF CI 73053)		1
	J4	MS75084-17	2 COIL,RF, 27UH (V96906) 240-2040-000 A6L607		1
	J5	1N459	2 SEMICOND DEVICE, (V07688) 353-0206-000 A6CR604		1
	J6	1N459	2 SEMICOND DEVICE, (V07688) 353-0206-000 A6CR605		1
	J7	2C067103X0101A3	2 CAPACITOR,FXD, CER DIEL, 0.01UF, 20%, 100V (V56289) 913-4240-100 A6C623		1
	J8	2C067104X0101A3	2 CAPACITOR,FXD, CER DIEL, 0.1UF, 20%, 100V (V56289) 913-4240-040 A6C622		1
	J9	55D2670F	2 RESISTOR,FXD, FILM, 267 OHMS, 1%, 1/8W (V96214) 705-1469-670 A6R616		1
	J40	RCR07G682KS	2 RESISTOR,FXD, CMPSN, 6.8K, 10%, 1/4W (V81349) 745-0779-000 A6R619		1
	J41	2C067103X0101A3	2 CAPACITOR,FXD, CER DIEL, 0.01UF, 20%, 100V (V56289) 913-4240-100 A6C624		1
	J42	MS90537-41	2 COIL,RF, 220UH (V96906) 240-2715-410 A6L610		1
	J43	MS90537-41	2 COIL,RF, 220UH (V96906) 240-2715-410 A6L609		1
	J44	2C067103X0101A3	2 CAPACITOR,FXD, CER DIEL, 0.01UF, 20%, 100V (V56289) 913-4240-100 A6C626		1
	J45	RCR07G222KS	2 RESISTOR,FXD, CMPSN, 2.2K, 10%, 1/4W (V81349) 745-0761-000 A6R621		1
	J46	2C067104X0101A3	2 CAPACITOR,FXD, CER DIEL, 0.1UF, 20%, 100V (V56289) 913-4240-040 A6C625		1
	J47	RCR07G470KS	2 RESISTOR,FXD, CMPSN, 47 OHMS, 10%, 1/4W (V81349) 745-0701-000 A6R620		1
	J48	RCR07G101KS	2 RESISTOR,FXD, CMPSN, 100 OHMS, 10%, 1/4W (V81349) 745-0713-000 A6R601		1
	J49	1N5767	2 SEMICOND DEVICE, (V07688) 922-6119-010 A6CR603		1
	J50	1N3070	2 SEMICOND DEVICE, (V07688) 353-3083-000 A6CR602		1
	J51	1N3070	2 SEMICOND DEVICE, (V07688) 353-3083-000 A6CR601		1
	J52	M39003-01-2111	2 CAPACITOR,FXD, ELCTLT, 0.47UF, 20%, 50V (V81349) 1A4-9084-380 A6C607		1
	J53	RCR05G472JS	2 RESISTOR,FXD, CMPSN, 4.7K, 5%, 1/8W (V81349) 745-1863-650 A6R611		1
	J54	DM5C080D050WV	2 CAPACITOR,FXD, MICA DIEL, 8PF, 0.5PF, 50V (V72136) 912-4141-110 A6C627		1
	J55	DM5C150D050WV	2 CAPACITOR,FXD, MICA DIEL, 15PF, 0.5PF, 50V (V72136) 912-4141-130 A6C615		1
	J56	DM5E510J050WV	2 CAPACITOR,FXD, MICA DIEL, 51PF, 5%, 50V (V72136) 912-4141-300 A6C616 (EFF TO CI 72314)		1
	J56	DM5E430J050WV	2 CAPACITOR,FXD, MICA DIEL, 43PF, 5%, 50V (V72136) 912-4141-260 A6C616 (EFF CI 72314)		1
	J57	RCR05G472JS	2 RESISTOR,FXD, CMPSN, 4.7K, 5%, 1/8W (V81349) 745-1863-650 A6R612		1
	J58	RG178BU	2 CABLE,RF, (V81349) 425-1538-000		AR
	J59	140-0530-9014	2 CABLE ASSY,ELEC, (V98278) 426-5435-270 A6P4		1
	J60	609-1641-001	2 CHASSIS		1
	J61	SS5170	3 TERMINAL,FEEDTH, (V86577) 306-0989-000		12
	J62	SL354-351WHT	3 TERMINAL,FEEDTH, (V12615) 306-2474-010		24
	J63	SL481-491WHT	3 TERMINAL,STUD, (V12615) 306-2511-100		18
	J64	R22NCFMA1-26	3 NUT,SLFLKG, CD PL STL, 2-56 (V72962) 333-0837-000		2
	J65	609-1638-001	3 FASTENER,ANGLE		2
	J66	609-1568-001	3 CHASSIS		1

GROUP ASSEMBLY PARTS LIST

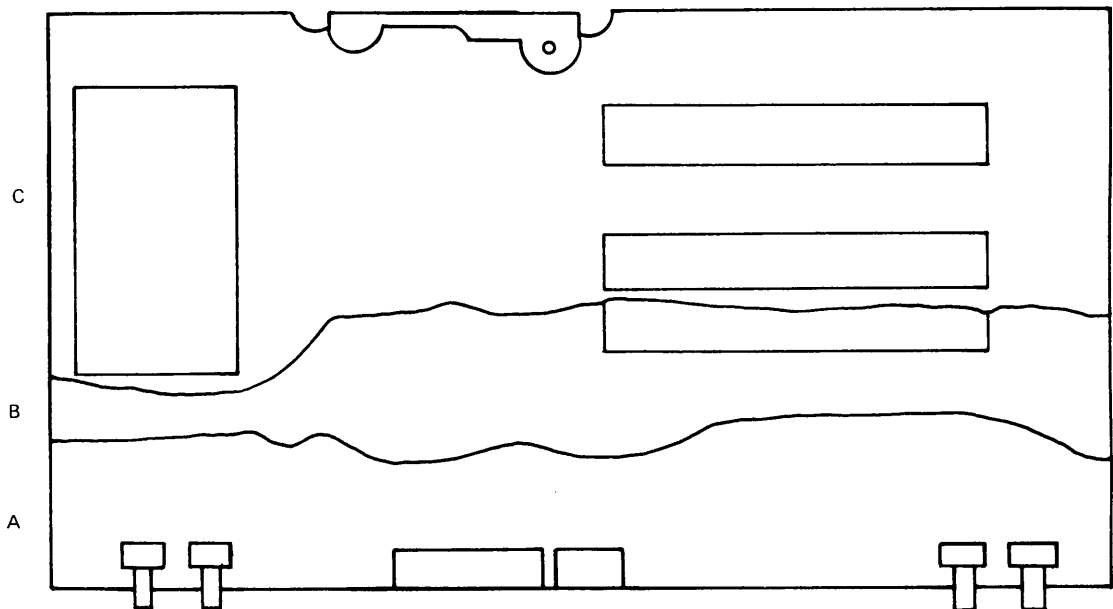

*IF Filter Circuit Card Assembly (A5A1) 797-3571-001, -006, -007, -010, -011, -012  
Figure 19 (Sheet 1 of 4)*

GROUP ASSEMBLY PARTS LIST

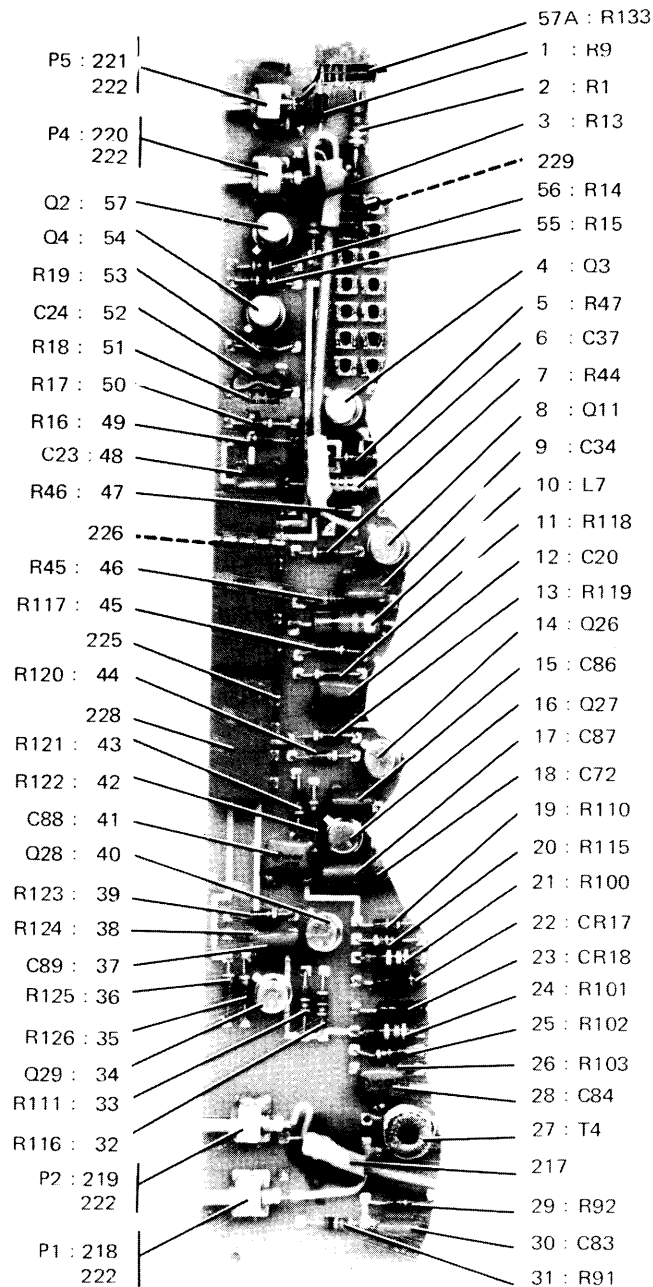

DETAIL A

TP3-1034-047

IF Filter Circuit Card Assembly (A5A1) 797-3571-001, -006, -007, -010, -011, -012  
Figure 19 (Sheet 2 of 4)

GROUP ASSEMBLY PARTS LIST

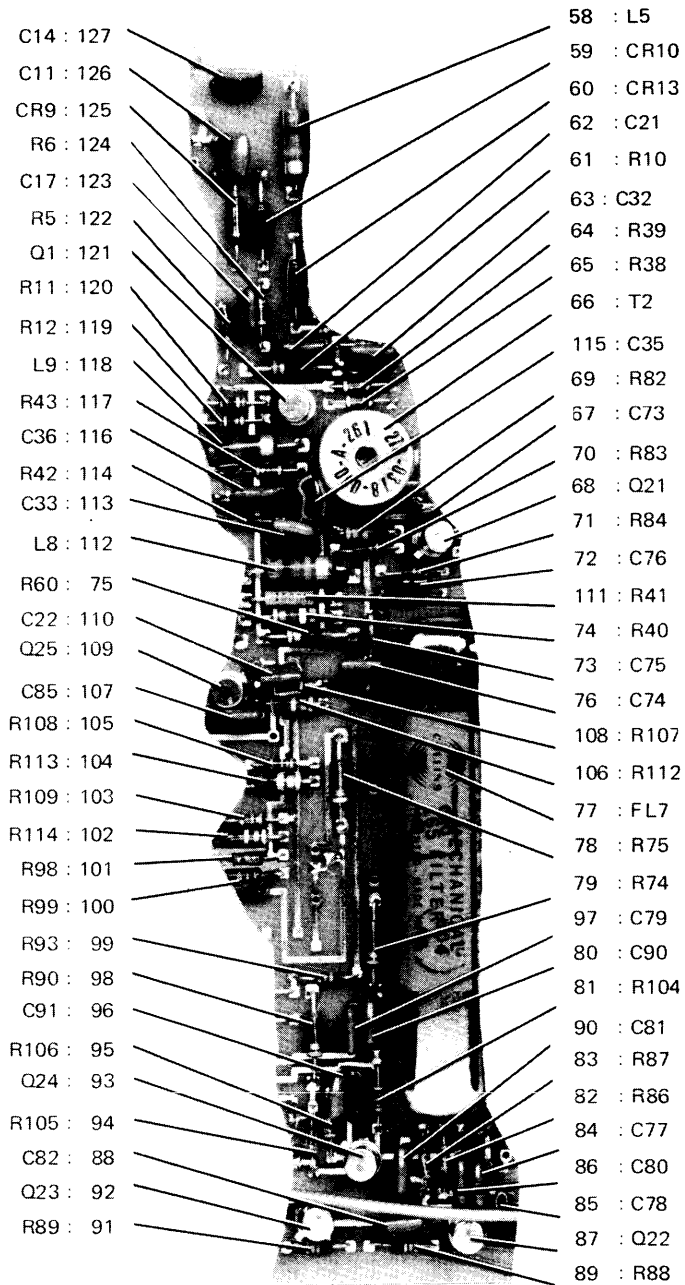

DETAIL B

TP3-1034-047

IF Filter Circuit Card Assembly (A5A1) 797-3571-001, -006, -007, -010, -011, -012  
Figure 19 (Sheet 3 of 4)

GROUP ASSEMBLY PARTS LIST

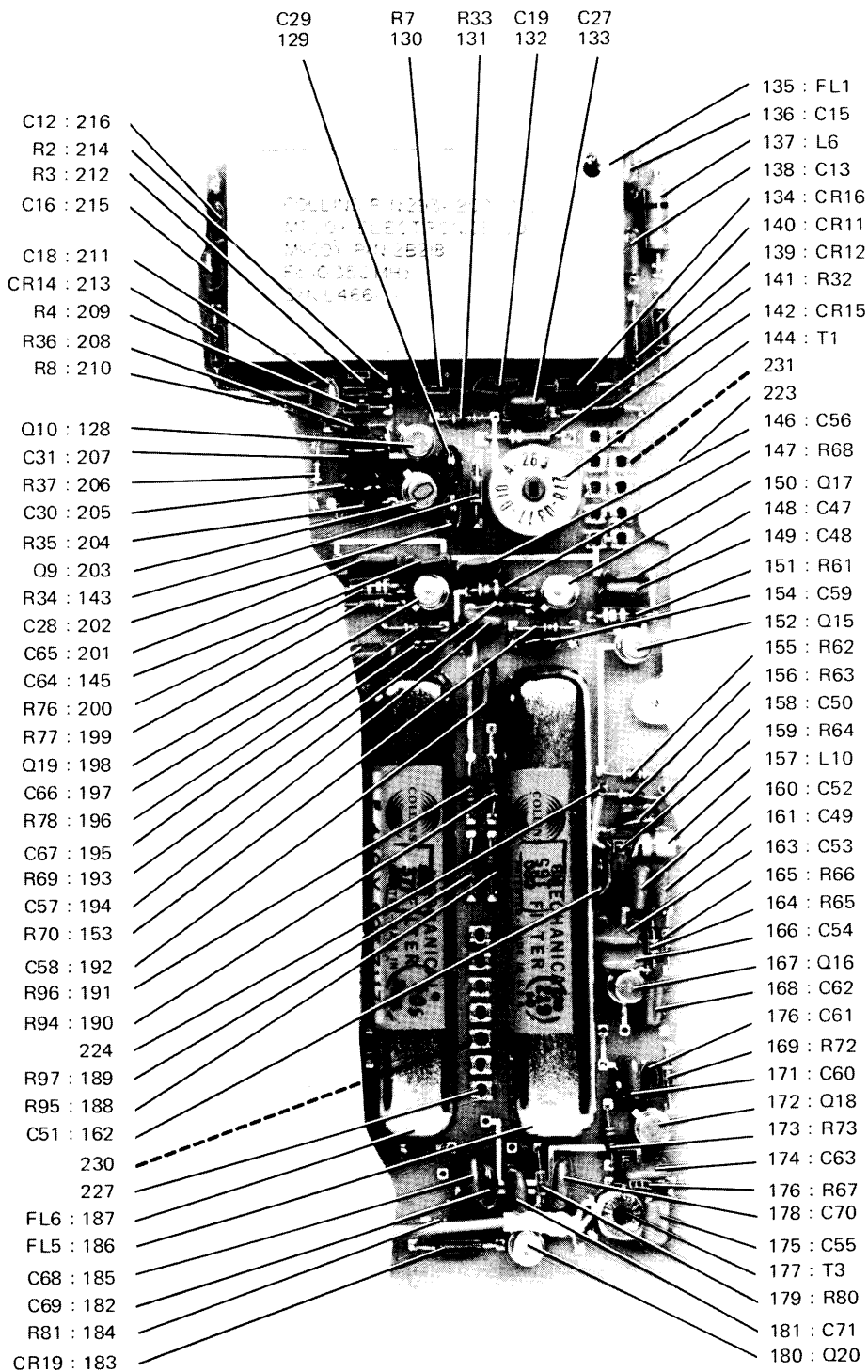

DETAIL C

TP3-1034-047

IF Filter Circuit Card Assembly (A5A1) 797-3571-001, -006, -007, -010, -011, -012  
Figure 19 (Sheet 4 of 4)



## GROUP ASSEMBLY PARTS LIST

FIG - ITEM	PART NO	INDENT	DESCRIPTION	USABLE ON CODE	UNITS PER ASSY
19 -	797-3571-001	1	CIRCUIT CARD ASSY, IF FILTER A5A1 (SEE FIG 1-19 FOR NHA)	AY	RF
-	797-3571-006	1	CIRCUIT CARD ASSY, IF FILTER A5A1 (SEE FIG 1-19 FOR NHA)	AZ	RF
-	797-3571-007	1	CIRCUIT CARD ASSY, IF FILTER A5A1 (SEE FIG 1-19 FOR NHA)	BA	RF
-	797-3571-010	1	CIRCUIT CARD ASSY, IF FILTER A5A1 (SEE FIG 1-19 FOR NHA)	BB	RF
-	797-3571-011	1	CIRCUIT CARD ASSY, IF FILTER A5A1 (SEE FIG 1-19 FOR NHA)	BC	RF
	797-3571-012	1	CIRCUIT CARD ASSY, IF FILTER A5A1 (SEE FIG 1-19 FOR NHA)	BD	RF
1	RCR07G101KS	2	RESISTOR,FXD, CMPSN, 100 OHMS, 10%, 1/4W (V81349) 745-0713-000 A5A1R9		1
2	RCR07G152KS	2	RESISTOR,FXD, CMPSN, 1.5K, 10%, 1/4W (V81349) 745-0755-000 A5A1R1		1
3	RCR07G222KS	2	RESISTOR,FXD, CMPSN, 2.2K, 10%, 1/4W (V81349) 745-0761-000 A5A1R13		1
4	2N2222A	2	TRANSISTOR, (V81350) 352-7500-280 A5A1Q3		1
5	RCR07G102KS	2	RESISTOR,FXD, CMPSN, 1K, 10%, 1/4W (V81349) 745-0749-000 A5A1R47		1
6	M39003-01-2029	2	CAPACITOR,FXD, ELCTLT, 3.3UF, 20%, 15V (V81349) 1R4-9083-290 A5A1C37		1
7	RCR07G820KS	2	RESISTOR,FXD, CMPSN, 82 OHMS, 10%, 1/4W (V81349) 745-0710-000 A5A1R44		1
8	2N2222A	2	TRANSISTOR, (V81350) 352-7500-280 A5A1Q11		1
9	2C067103X0101A3	2	CAPACITOR,FXD, CER DIEL, 0.01UF, 20%, 100V (V56289) 913-4240-100 A5A1C34		1
10	MS90538-04	2	COIL,RF, 47UH (V96906) 240-2508-000 A5A1L7		1
11	RCR07G222KS	2	RESISTOR,FXD, CMPSN, 2.2K, 10%, 1/4W (V81349) 745-0761-000 A5A1R118		1
12	2C067103X0101A3	2	CAPACITOR,FXD, CER DIEL, 0.01UF, 20%, 100V (V56289) 913-4240-100 A5A1C20		1
13	RCR07G222KS	2	RESISTOR,FXD, CMPSN, 2.2K, 10%, 1/4W (V81349) 745-0761-000 A5A1R119		1
14	2N2907A	2	TRANSISTOR, (V07688) 352-0551-010 A5A1Q26		1
15	2C067103X0101A3	2	CAPACITOR,FXD, CER DIEL, 0.01UF, 20%, 100V (V56289) 913-4240-100 A5A1C86		1
16	2N2907A	2	TRANSISTOR, (V07688) 352-0551-010 A5A1Q27		1
17	2C067103X0101A3	2	CAPACITOR,FXD, CER DIEL, 0.01UF, 20%, 100V (V56289) 913-4240-100 A5A1C87		1
18	8131-050-651-104 M	2	CAPACITOR,FXD, CER DIEL, 0.1UF, 20%, 50V (V72982) 913-3279-200 A5A1C72		1
19	RCR07G223KS	2	RESISTOR,FXD, CMPSN, 22K, 10%, 1/4W (V81349) 745-0797-000 A5A1R110		1
20	RCR07G473KS	2	RESISTOR,FXD, CMPSN, 47K, 10%, 1/4W (V81349) 745-0809-000 A5A1R115		1
21	RCR07G104KS	2	RESISTOR,FXD, CMPSN, 0.10MEGO, 10%, 1/4W (V81349) 745-0821-000 A5A1R100		1
22	1N459	2	SEMICOND DEVICE, (V07688) 353-0206-000 A5A1CR17		1
23	1N459	2	SEMICOND DEVICE, (V07688) 353-0206-000 A5A1CR18		1
24	RCR07G104KS	2	RESISTOR,FXD, CMPSN, 0.10MEGO, 10%, 1/4W (V81349) 745-0821-000 A5A1R101		1
25	RCR07G103KS	2	RESISTOR,FXD, CMPSN, 10K, 10%, 1/4W (V81349) 745-0785-000 A5A1R102		1
26	RCR07G103KS	2	RESISTOR,FXD, CMPSN, 10K, 10%, 1/4W (V81349) 745-0785-000 A5A1R103		1
27	606-9440-001	2	TRANSFORMER, A5A1T4		1
28	8131-050-651-104 M	2	CAPACITOR,FXD, CER DIEL, 0.1UF, 20%, 50V (V72982) 913-3279-200 A5A1C84		1
29	RCR07G101KS	2	RESISTOR,FXD, CMPSN, 100 OHMS, 10%, 1/4W (V81349) 745-0713-000 A5A1R92		1

GROUP ASSEMBLY PARTS LIST

FIG - ITEM	PART NO	INDENT	DESCRIPTION	USABLE ON CODE	UNITS PER ASSY
19	30	2C067103X0101A3	2 CAPACITOR,FXD, CER DIEL, 0.01UF, 20%, 100V (V56289) 913-4240-100 A5A1C83		1
	31	RCR07G103KS	2 RESISTOR,FXD, CMPSN, 10K, 10%, 1/4W (V81349) 745-0785-000 A5A1R91		1
	32	RCR07G473KS	2 RESISTOR,FXD, CMPSN, 47K, 10%, 1/4W (V81349) 745-0809-000 A5A1R116		1
	33	RCR07G222KS	2 RESISTOR,FXD, CMPSN, 22K, 10%, 1/4W (V81349) 745-0797-000 A5A1R111		1
	34	2N2907A	2 TRANSISTOR, (V07688) 352-0551-010 A5A1Q29		1
	35	RCR07G222KS	2 RESISTOR,FXD, CMPSN, 2.2K, 10%, 1/4W (V81349) 745-0761-000 A5A1R126		1
	36	RCR07G222KS	2 RESISTOR,FXD, CMPSN, 2.2K, 10%, 1/4W (V81349) 745-0761-000 A5A1R125		1
	37	2C067103X0101A3	2 CAPACITOR,FXD, CER DIEL, 0.01UF, 20%, 100V (V56289) 913-4240-100 A5A1C89		1
	38	RCR07G222KS	2 RESISTOR,FXD, CMPSN, 2.2K, 10%, 1/4W (V81349) 745-0761-000 A5A1R124		1
	39	RCR07G222KS	2 RESISTOR,FXD, CMPSN, 2.2K, 10%, 1/4W (V81349) 745-0761-000 A5A1R123		1
	40	2N2907A	2 TRANSISTOR, (V07688) 352-0551-010 A5A1Q28		1
	41	2C067103X0101A3	2 CAPACITOR,FXD, CER DIEL, 0.01UF, 20%, 100V (V56289) 913-4240-100 A5A1C88		1
	42	RCR07G222KS	2 RESISTOR,FXD, CMPSN, 2.2K, 10%, 1/4W (V81349) 745-0761-000 A5A1R122		1
	43	RCR07G222KS	2 RESISTOR,FXD, CMPSN, 2.2K, 10%, 1/4W (V81349) 745-0761-000 A5A1R121		1
	44	RCR07G222KS	2 RESISTOR,FXD, CMPSN, 2.2K, 10%, 1/4W (V81349) 745-0761-000 A5A1R120		1
	45	RCR07G222KS	2 RESISTOR,FXD, CMPSN, 2.2K, 10%, 1/4W (V81349) 745-0761-000 A5A1R117		1
	46	T055-3010-1F	2 RESISTOR,FXD, FILM, 301 OHMS, 1%, 1/8W (V11502) 705-1470-490 A5A1R45		1
	47	RCR07G560KS	2 RESISTOR,FXD, CMPSN, 56 OHMS, 10%, 1/4W (V81349) 745-0704-000 A5A1R46		1
	48	2C067103X0101A3	2 CAPACITOR,FXD, CER DIEL, 0.01UF, 20%, 100V (V56289) 913-4240-100 A5A1C23		1
	49	RCR07G222KS	2 RESISTOR,FXD, CMPSN, 2.2K, 10%, 1/4W (V81349) 745-0761-000 A5A1R16		1
	50	RCR07G152KS	2 RESISTOR,FXD, CMPSN, 1.5K, 10%, 1/4W (V81349) 745-0755-000 A5A1R17		1
	51	RCR07G222KS	2 RESISTOR,FXD, CMPSN, 2.2K, 10%, 1/4W (V81349) 745-0761-000 A5A1R18		1
	52	2C067103X0101A3	2 CAPACITOR,FXD, CER DIEL, 0.01UF, 20%, 100V (V56289) 913-4240-100 A5A1C24		1
	53	RCR07G152KS	2 RESISTOR,FXD, CMPSN, 1.5K, 10%, 1/4W (V81349) 745-0755-000 A5A1R19		1
	54	2N2222A	2 TRANSISTOR, (V81350) 352-7500-280 A5A1Q4		1
	55	RCR07G392KS	2 RESISTOR,FXD, CMPSN, 3.9K, 10%, 1/4W (V81349) 745-0770-000 A5A1R15		1
	56	RCR07G392KS	2 RESISTOR,FXD, CMPSN, 3.9K, 10%, 1/4W (V81349) 745-0770-000 A5A1R14		1
	57	2N2907A	2 TRANSISTOR, (V07688) 352-0551-010 A5A1Q2		1
	57A	RCR07G220KS	2 RESISTOR,FXD, CMPSN, 22 OHMS, 10%, 1/4W (V81349) 745-0689-000 A5A1R133 (EFF CI 72426)		1
	58	MS90538-04	2 COIL,RF, 47UH (V96906) 240-2508-000 A5A1L5		1
	59	1N459	2 SEMICOND DEVICE, (V07688) 353-0206-000 A5A1CR10		1
	60	1N459	2 SEMICOND DEVICE, (V07688) 353-0206-000 A5A1CR13		1
	61	RCR07G222KS	2 RESISTOR,FXD, CMPSN, 2.2K, 10%, 1/4W (V81349) 745-0761-000 A5A1R10		1
	62	2C067103X0101A3	2 CAPACITOR,FXD, CER DIEL, 0.01UF, 20%, 100V (V56289) 913-4240-100 A5A1C21		1
	63	2C067103X0101A3	2 CAPACITOR,FXD, CER DIEL, 0.01UF, 20%, 100V (V56289) 913-4240-100 A5A1C32		1

GROUP ASSEMBLY PARTS LIST

FIG - ITEM	PART NO	INDENT	DESCRIPTION	USABLE ON CODE	UNITS PER ASSY
19 64	RCR07G471KS	2	RESISTOR,FXD, CMPSN, 470 OHMS, 10%, 1/4W (V81349) 745-0737-000 A5A1R39		1
65	RCR07G471KS	2	RESISTOR,FXD, CMPSN, 470 OHMS, 10%, 1/4W (V81349) 745-0737-000 A5A1R38		1
66	A261	2	TRANSFORMER,RF, (V81815) 278-0378-010 A5A1T2		1
67	K05SK102M	2	CAPACITOR,FXD, CER DIEL, 1000PF, 10%, 100V (V05397) 913-4489-360 A5A1C73		1
68	2N4416	2	TRANSISTOR, (V17896) 352-0756-010 A5A1Q21		1
69	RCR07G104KS	2	RESISTOR,FXD, CMPSN, 0.10MEGO, 10%, 1/4W (V81349) 745-0821-000 A5A1R82		1
70	RCR07G272KS	2	RESISTOR,FXD, CMPSN, 2.7K, 10%, 1/4W (V81349) 745-0764-000 A5A1R83 (EFF TO CI 73076)	AY,BA,RB ,BC,RD	1
70	RCR07G272KS	2	RESISTOR,FXD, CMPSN, 2.7K, 10%, 1/4W (V81349) 745-0764-000 A5A1R83 (EFF TO CI 73046)	AZ	1
	608-9278-001	2	RESISTOR KIT, (EFF CI 73076) (NON-PROCURABLE ITEM)	AY,BA,BB ,BC,BD	1
	608-9278-001	2	RESISTOR KIT, (EFF CI 73046) (NON-PROCURABLE ITEM)	AZ	1
70	RCR07G122KS	3	RESISTOR,FXD, CMPSN, 1.2K, 10%, 1/4W (V81349) 745-0752-000 A5A1R83		AR
70	RCR07G152KS	3	RESISTOR,FXD, CMPSN, 1.5K, 10%, 1/4W (V81349) 745-0755-000 A5A1R83		AR
70	RCR07G182KS	3	RESISTOR,FXD, CMPSN, 1.8K, 10%, 1/4W (V81349) 745-0758-000 A5A1R83		AR
70	RCR07G222KS	3	RESISTOR,FXD, CMPSN, 2.2K, 10%, 1/4W (V81349) 745-0761-000 A5A1R83		AR
70	RCR07G272KS	3	RESISTOR,FXD, CMPSN, 2.7K, 10%, 1/4W (V81349) 745-0764-000 A5A1R83		AR
70	RCR07G332KS	3	RESISTOR,FXD, CMPSN, 3.3K, 10%, 1/4W (V81349) 745-0767-000 A5A1R83		AR
71	RCR07G223KS	2	RESISTOR,FXD, CMPSN, 22K, 10%, 1/4W (V81349) 745-0797-000 A5A1R84		1
72	D45E270J050WV	2	CAPACITOR,FXD, MICA DIEL, 27PF, 5%, 50V (V72136) 912-4141-180 A5A1C76		1
73	2C067103X0101A3	2	CAPACITOR,FXD, CER DIEL, 0.01UF, 20%, 100V (V56289) 913-4240-100 A5A1C75		1
74	RCR07G391JS	2	RESISTOR,FXD, CMPSN, 390 OHMS, 5%, 1/4W (V81349) 745-0733-000 A5A1R40		1
75	RCR07G102KS	2	RESISTOR,FXD, CMPSN, 1K, 10%, 1/4W (V81349) 745-0749-000 A5A1R80		1
76	2C067103X0101A3	2	CAPACITOR,FXD, CER DIEL, 0.01UF, 20%, 100V (V56289) 913-4240-100 A5A1C74		1
77	526-9652-010	2	FILTER, A5A1FL7 (EFF TO CI 72353)	AY	1
77	526-9734-020	2	FILTER, A5A1FL7 (EFF CI 72353 TO CI 73016)	AY	1
77	526-9652-010	2	FILTER, A5A1FL7 (EFF CI 73016)	AY	1
77	526-9652-050	2	FILTER, A5A1FL7	AZ	1
77	526-9734-020	2	FILTER, A5A1FL7	BA,BC	1
77	526-9652-010	2	FILTER, A5A1FL7 (EFF TO CI 72433)	BR	1
77	526-9734-020	2	FILTER, A5A1FL7 (EFF CI 72433)	BB	1
77	526-9679-010	2	FILTER, A5A1FL7	BD	1
	68-1660-40	2	NUT,SLFLKG,HEX, AL, 4-40 (V72962) 333-0605-000 (AP)		2
78	RCR07G101KS	2	RESISTOR,FXD, CMPSN, 100 OHMS, 10%, 1/4W (V81349) 745-0713-000 A5A1R75		1
79	RCR07G102KS	2	RESISTOR,FXD, CMPSN, 1K, 10%, 1/4W (V81349) 745-0749-000 A5A1R74		1
80	2C067103X0101A3	2	CAPACITOR,FXD, CER DIEL, 0.01UF, 20%, 100V (V56289) 913-4240-100 A5A1C90		1
81	RCR07G473KS	2	RESISTOR,FXD, CMPSN, 47K, 10%, 1/4W (V81349) 745-0809-000 A5A1R104		1
82	RCR07G473KS	2	RESISTOR,FXD, CMPSN, 47K, 10%, 1/4W (V81349) 745-0809-000 A5A1R86		1

GROUP ASSEMBLY PARTS LIST

FIG - ITEM	PART NO	INDENT	DESCRIPTION	USABLE ON CODE	UNITS PER ASSY
19	83		RCR07G331KS		
		2	RESISTOR,FXD, CMPSN, 330 OHMS, 10%, 1/4W (V81349) 745-0731-000 A5A1R87		1
	84		2C067103X0101A3		
		2	CAPACITOR,FXD, CER DIEI, 0.01UF, 20%, 100V (V56289) 913-4240-100 A5A1C77		1
	85		DM5C180D050WV		
		2	CAPACITOR,FXD, MICA DIEI, 18PF, 0.5PF, 50V (V72136) 912-4141-140 A5A1C78		1
	86		2C067103X0101A3		
		2	CAPACITOR,FXD, CER DIEI, 0.01UF, 20%, 100V (V56289) 913-4240-100 A5A1C80		1
	87		2N4416		
		2	TRANSISTOR, (V17896) 352-0756-010 A5A1Q22		1
	88		2C067103X0101A3		
		2	CAPACITOR,FXD, CER DIEI, 0.01UF, 20%, 100V (V56289) 913-4240-100 A5A1C82		1
	89		RCR07G224KS		
		2	RESISTOR,FXD, CMPSN, 0.22MEGO, 10%, 1/4W (V81349) 745-0833-000 A5A1R88		1
	90		2C067103X0101A3		
		2	CAPACITOR,FXD, CER DIEI, 0.01UF, 20%, 100V (V56289) 913-4240-100 A5A1C81		1
	91		RCR07G153KS		
		2	RESISTOR,FXD, CMPSN, 15K, 10%, 1/4W (V81349) 745-0791-000 A5A1R89		1
	92		2N4416		
		2	TRANSISTOR, (V17896) 352-0756-010 A5A1Q23		1
	93		2N4416		
		2	TRANSISTOR, (V17896) 352-0756-010 A5A1Q24		1
	94		RCR07G272KS		
		2	RESISTOR,FXD, CMPSN, 2.7K, 10%, 1/4W (V81349) 745-0764-000 A5A1R105		1
	95		RCR07G331KS		
		2	RESISTOR,FXD, CMPSN, 330 OHMS, 10%, 1/4W (V81349) 745-0731-000 A5A1R106		1
	96		2C067103X0101A3		
		2	CAPACITOR,FXD, CER DIEI, 0.01UF, 20%, 100V (V56289) 913-4240-100 A5A1C91		1
	97		2C067103X0101A3		
		2	CAPACITOR,FXD, CER DIEI, 0.01UF, 20%, 100V (V56289) 913-4240-100 A5A1C79		1
	98		RCR07G102KS		
		2	RESISTOR,FXD, CMPSN, 1K, 10%, 1/4W (V81349) 745-0749-000 A5A1R90		1
	99		RCR07G103KS		
		2	RESISTOR,FXD, CMPSN, 10K, 10%, 1/4W (V81349) 745-0785-000 A5A1R93		1
	100		RCR07G103KS		
		2	RESISTOR,FXD, CMPSN, 10K, 10%, 1/4W (V81349) 745-0785-000 A5A1R99		1
	101		RCR07G103KS		
		2	RESISTOR,FXD, CMPSN, 10K, 10%, 1/4W (V81349) 745-0785-000 A5A1R98		1
	102		RCR07G104KS		
		2	RESISTOR,FXD, CMPSN, 0.10MEGO, 10%, 1/4W (V81349) 745-0821-000 A5A1R114		1
	103		RCR07G473KS		
		2	RESISTOR,FXD, CMPSN, 47K, 10%, 1/4W (V81349) 745-0809-000 A5A1R109		1
	104		RCR07G104KS		
		2	RESISTOR,FXD, CMPSN, 0.10MEGO, 10%, 1/4W (V81349) 745-0821-000 A5A1R113		1
	105		RCR07G473KS		
		2	RESISTOR,FXD, CMPSN, 47K, 10%, 1/4W (V81349) 745-0809-000 A5A1R108		1
	106		RCR07G104KS		
		2	RESISTOR,FXD, CMPSN, 0.10MEGO, 10%, 1/4W (V81349) 745-0821-000 A5A1R112		1
	107		2C067103X0101A3		
		2	CAPACITOR,FXD, CER DIEI, 0.01UF, 20%, 100V (V56289) 913-4240-100 A5A1C85		1
	108		RCR07G473KS		
		2	RESISTOR,FXD, CMPSN, 47K, 10%, 1/4W (V81349) 745-0809-000 A5A1R107		1
	109		2N2907A		
		2	TRANSISTOR, (V07688) 352-0551-010 A5A1Q25		1
	110		2C067103X0101A3		
		2	CAPACITOR,FXD, CER DIEI, 0.01UF, 20%, 100V (V56289) 913-4240-100 A5A1C22		1
	111		T055-1500-1F		
		2	RESISTOR,FXD, FILM, 1.5K, 1%, 1/8W (V11502) 705-1468-020 A5A1R41		1
	112		MS90538-04		
		2	COIL,RF, 47UH (V96906) 240-2508-000 A5A11.8		1
	113		8131-050-651-104 M		
		2	CAPACITOR,FXD, CER DIEI, 0.1UF, 20%, 50V (V72982) 913-3279-200 A5A1C33		1
	114		RCR07G100KS		
		2	RESISTOR,FXD, CMPSN, 10 OHMS, 10%, 1/4W (V81349) 745-0677-000 A5A1R42		1
	115		2C067103X0101A3		
		2	CAPACITOR,FXD, CER DIEI, 0.01UF, 20%, 100V (V56289) 913-4240-100 A5A1C35		1
	116		2C067103X0101A3		
		2	CAPACITOR,FXD, CER DIEI, 0.01UF, 20%, 100V (V56289) 913-4240-100 A5A1C36		1

## GROUP ASSEMBLY PARTS LIST

FIG - ITEM	PART NO	INDENT	DESCRIPTION	USABLE ON CODE	UNITS PER ASSY
19 117	RCR07G471KS	2	RESISTOR,FXD, CMPSN, 470 OHMS, 10%, 1/4W (V81349) 745-0737-000 A5A1R43		1
118	1537-48	2	COIL,RF, 27UH (V99800) 240-2502-000 A5A1L9		1
119	RCR07G392KS	2	RESISTOR,FXD, CMPSN, 3.9K, 10%, 1/4W (V81349) 745-0770-000 A5A1R12		1
120	RCR07G392KS	2	RESISTOR,FXD, CMPSN, 3.9K, 10%, 1/4W (V81349) 745-0770-000 A5A1R11		1
121	2N2907A	2	TRANSISTOR, (V07688) 352-0551-010 A5A1Q1		1
122	RCR07G470KS	2	RESISTOR,FXD, CMPSN, 47 OHMS, 10%, 1/4W (V81349) 745-0701-000 A5A1R5		1
123	2C067103X0101A3	2	CAPACITOR,FXD, CER DIEI, 0.01UF, 20%, 100V (V56289) 913-4240-100 A5A1C17		1
124	RCR07G471KS	2	RESISTOR,FXD, CMPSN, 470 OHMS, 10%, 1/4W (V81349) 745-0737-000 A5A1R6		1
125	1N459	2	SEMICOND DEVICE, (V07688) 353-0206-000 A5A1CR9		1
126	2C067103X0101A3	2	CAPACITOR,FXD, CER DIEI, 0.01UF, 20%, 100V (V56289) 913-4240-100 A5A1C11		1
127	2C067103X0101A3	2	CAPACITOR,FXD, CER DIEI, 0.01UF, 20%, 100V (V56289) 913-4240-100 A5A1C14		1
128	2N4416A	2	TRANSISTOR, (V17896) 352-0756-020 A5A1Q10		1
129	DM5F101J050WV	2	CAPACITOR,FXD, MICA DIEI, 100PF, 5%, 50V (V72136) 912-4141-050 A5A1C29		1
130	RCR07G471KS	2	RESISTOR,FXD, CMPSN, 470 OHMS, 10%, 1/4W (V81349) 745-0737-000 A5A1R7		1
131	RCR07G472KS	2	RESISTOR,FXD, CMPSN, 4.7K, 10%, 1/4W (V81349) 745-0773-000 A5A1R33		1
132	2C067103X0101A3	2	CAPACITOR,FXD, CER DIEI, 0.01UF, 20%, 100V (V56289) 913-4240-100 A5A1C19		1
133	2C067103X0101A3	2	CAPACITOR,FXD, CER DIEI, 0.01UF, 20%, 100V (V56289) 913-4240-100 A5A1C27		1
134	1N459	2	SEMICOND DEVICE, (V07688) 353-0206-000 A5A1CR16		1
135	2B21A	2	FILTER,BP, (V00136) 293-1250-010 A5A1FL1	AY,AZ,BC ,BD	1
135	2B298 68-1660-40	2	FILTER,BP,XTAL, (V00136) 293-1271-010 A5A1FL1	BA	1
		2	NUT,SLFLKG,HEX, AL, 4-40 (V72962) 333-0605-000 (AP)	AY,AZ,BA ,BC,BD	2
136	2C067103X0101A3	2	CAPACITOR,FXD, CER DIEI, 0.01UF, 20%, 100V (V56289) 913-4240-100 A5A1C15		1
137	M590538-04	2	COIL,RF, 47UH (V96906) 240-2508-000 A5A1L6		1
138	2C067103X0101A3	2	CAPACITOR,FXD, CER DIEI, 0.01UF, 20%, 100V (V56289) 913-4240-100 A5A1C13		1
139	1N459	2	SEMICOND DEVICE, (V07688) 353-0206-000 A5A1CR12		1
140	1N459	2	SEMICOND DEVICE, (V07688) 353-0206-000 A5A1CR11		1
141	RCR07G152KS	2	RESISTOR,FXD, CMPSN, 1.5K, 10%, 1/4W (V81349) 745-0755-000 A5A1R32		1
142	1N459	2	SEMICOND DEVICE, (V07688) 353-0206-000 A5A1CR15		1
143	RCR07G682KS	2	RESISTOR,FXD, CMPSN, 6.8K, 10%, 1/4W (V81349) 745-0779-000 A5A1R34		1
144	A263	2	TRANSFORMER,RF, (V81815) 278-0377-010 A5A1T1		1
145	K05SK102M	2	CAPACITOR,FXD, CER DIEI, 1000PF, 10%, 100V (V05397) 913-4489-360 A5A1C64		1
146	K05SK102M	2	CAPACITOR,FXD, CER DIEI, 1000PF, 10%, 100V (V05397) 913-4489-360 A5A1C56		1
147	RCR07G104KS	2	RESISTOR,FXD, CMPSN, 0.10MEGO, 10%, 1/4W (V81349) 745-0821-000 A5A1R68		1
148	K05SK102M	2	CAPACITOR,FXD, CER DIEI, 1000PF, 10%, 100V (V05397) 913-4489-360 A5A1C47		1
149	2C067103X0101A3	2	CAPACITOR,FXD, CER DIEI, 0.01UF, 20%, 100V (V56289) 913-4240-100 A5A1C48		1
150	2N4416	2	TRANSISTOR, (V17896) 352-0756-010 A5A1Q17		1
151	RCR07G104KS	2	RESISTOR,FXD, CMPSN, 0.10MEGO, 10%, 1/4W (V81349) 745-0821-000 A5A1R61		1
152	2N4416	2	TRANSISTOR, (V17896) 352-0756-010 A5A1Q15		1

GROUP ASSEMBLY PARTS LIST

FIG - ITEM	PART NO	INDENT	DESCRIPTION	USABLE ON CODE	UNITS PER ASSY
19 153	RCR07G223KS	2	RESISTOR,FXD, CMPSN, 22K, 10%, 1/4W (V81349) 745-0797-000 A5A1R70		1
154	DM5E270J050WV	2	CAPACITOR,FXD, MICA DIEL, 27PF, 5%, 50V (V72136) 912-4141-180 A5A1C59		1
155	RCR07G331KS	2	RESISTOR,FXD, CMPSN, 330 OHMS, 10%, 1/4W (V81349) 745-0731-000 A5A1R62		1
156	RCR07G202JS	2	RESISTOR,FXD, CMPSN, 2K, 5%, 1/4W (V81349) 745-0759-000 A5A1R63 (EFF TO CI 73136)		1
156	RCR07G332KS	2	RESISTOR, FXD, CMPSN, 3.3K, 10%, 1/4W (V81349) 745-0767-000 A5A1R63 (EFF CI 73136)		1
157	MS90537-49	2	COIL,RF, 1000UH (V96906) 240-2715-490 A5A1L10		1
158	DM5E240D050WV	2	CAPACITOR,FXD, MICA DIEL, 24PF, 0.5PF, 50V (V72136) 912-4141-160 A5A1C50		1
159	RCR05G102JS	2	RESISTOR,FXD, CMPSN, 1K, 5%, 1/8W (V81349) 745-1A63-490 A5A1R64		1
160	2C067103X0101A3	2	CAPACITOR,FXD, CER DIEL, 0.01UF, 20%, 100V (V56289) 913-4240-100 A5A1C52		1
161	2C067103X0101A3	2	CAPACITOR,FXD, CER DIEL, 0.01UF, 20%, 100V (V56289) 913-4240-100 A5A1C49		1
162	DM5E240D050WV	2	CAPACITOR,FXD, MICA DIEL, 24PF, 0.5PF, 50V (V72136) 912-4141-160 A5A1C51		1
163	2C067103X0101A3	2	CAPACITOR,FXD, CER DIEL, 0.01UF, 20%, 100V (V56289) 913-4240-100 A5A1C53		1
164	RCR07G223KS	2	RESISTOR,FXD, CMPSN, 22K, 10%, 1/4W (V81349) 745-0797-000 A5A1R65		1
165	RCR07G331KS	2	RESISTOR,FXD, CMPSN, 330 OHMS, 10%, 1/4W (V81349) 745-0731-000 A5A1R66		1
166	2C067103X0101A3	2	CAPACITOR,FXD, CER DIEL, 0.01UF, 20%, 100V (V56289) 913-4240-100 A5A1C54		1
167	2N4416	2	TRANSISTOR, (V17896) 352-0756-010 A5A1Q16		1
168	2C067103X0101A3	2	CAPACITOR,FXD, CER DIEL, 0.01UF, 20%, 100V (V56289) 913-4240-100 A5A1C62		1
169	RCR07G223KS	2	RESISTOR,FXD, CMPSN, 22K, 10%, 1/4W (V81349) 745-0797-000 A5A1R72		1
170	DM5C180D050WV	2	CAPACITOR,FXD, MICA DIEL, 18PF, 0.5PF, 50V (V72136) 912-4141-140 A5A1C61		1
171	2C067103X0101A3	2	CAPACITOR,FXD, CER DIEL, 0.01UF, 20%, 100V (V56289) 913-4240-100 A5A1C60		1
172	2N4416	2	TRANSISTOR, (V17896) 352-0756-010 A5A1Q16		1
173	RCR07G331KS	2	RESISTOR,FXD, CMPSN, 330 OHMS, 10%, 1/4W (V81349) 745-0731-000 A5A1R73		1
174	2C067103X0101A3	2	CAPACITOR,FXD, CER DIEL, 0.01UF, 20%, 100V (V56289) 913-4240-100 A5A1C63		1
175	8131-050-651-104 M	2	CAPACITOR,FXD, CER DIEL, 0.1UF, 20%, 50V (V72982) 913-3279-200 A5A1C55		1
176	RCR07G272KS	2	RESISTOR,FXD, CMPSN, 2.7K, 10%, 1/4W (V81349) 745-0764-000 A5A1R67		1
177	609-9440-001	2	TRANSFORMER, A5A1T3		1
178	2C067103X0101A3	2	CAPACITOR,FXD, CER DIEL, 0.01UF, 20%, 100V (V56289) 913-4240-100 A5A1C70		1
179	RCR07G223KS	2	RESISTOR,FXD, CMPSN, 22K, 10%, 1/4W (V81349) 745-0797-000 A5A1R80		1
180	2N4416	2	TRANSISTOR, (V17896) 352-0756-010 A5A1Q20		1
181	2C067103X0101A3	2	CAPACITOR,FXD, CER DIEL, 0.01UF, 20%, 100V (V56289) 913-4240-100 A5A1C71		1
182	DM5C180D050WV	2	CAPACITOR,FXD, MICA DIEL, 18PF, 0.5PF, 50V (V72136) 912-4141-140 A5A1C69		1
183	1N459	2	SEMICOND DEVICE, (V07688) 353-0206-000 A5A1CR19		1
184	RCR07G331KS	2	RESISTOR,FXD, CMPSN, 330 OHMS, 10%, 1/4W (V81349) 745-0731-000 A5A1R81		1
185	2C067103X0101A3	2	CAPACITOR,FXD, CER DIEL, 0.01UF, 20%, 100V (V56289) 913-4240-100 A5A1C68		1
186	526-9634-010	2	FILTER, A5A1FL5 (EFF TO CI 72353)	AY	1
186	526-9733-020	2	FILTER, A5A1FL5 (EFF CI 72353 TO CI 73016)	AY	1
186	526-9634-010	2	FILTER, A5A1FL5 (EFF CI 73016)	AY	1

## GROUP ASSEMBLY PARTS LIST

FIG - ITEM	PART NO	INDENT	DESCRIPTION	USABLE ON CODE	UNITS PER ASSY
19 186	526-9634-050	2	FILTER, A5A1FL5	AZ	1
186	526-9634-050	2	FILTER, A5A1FL5	BA, BC	1
186	526-9634-010	2	FILTER, A5A1FL5 (EFF TO CI 72433)	BB	1
186	526-9733-020	2	FILTER, A5A1FL5 (EFF CI 72433)	BB	1
186	526-9678-010	2	FILTER, A5A1FL5	BD	1
187	526-9643-010	2	FILTER, A5A1FL6		1
	68-1660-40	2	NUT, RFLKLG, HEX, AL, 4-40 (V72962) 333-0605-000 (AP FOR 186, 187)		4
188	RCR07G103KS	2	RESISTOR, FXD, CMPSN, 10K, 10%, 1/4W (V81349) 745-0785-000 A5A1R95		1
189	RCR07G103KS	2	RESISTOR, FXD, CMPSN, 10K, 10%, 1/4W (V81349) 745-0785-000 A5A1R97		1
190	RCR07G103KS	2	RESISTOR, FXD, CMPSN, 10K, 10%, 1/4W (V81349) 745-0785-000 A5A1R94		1
191	RCR07G103KS	2	RESISTOR, FXD, CMPSN, 10K, 10%, 1/4W (V81349) 745-0785-000 A5A1R96		1
192	2C067103X0101A3	2	CAPACITOR, FXD, CER DIEL, 0.01UF, 20%, 100V (V56289) 913-4240-100 A5A1C58		1
193	RCR07G272KS	2	RESISTOR, FXD, CMPSN, 2.7K, 10%, 1/4W (V81349) 745-0764-000 A5A1R69 (EFF TO CI 73076)	AY, BA, BB , BC, BD	1
193	RCR07G272KS	2	RESISTOR, FXD, CMPSN, 2.7K, 10%, 1/4W (V81349) 745-0764-000 A5A1R69 (EFF TO CI 73076)	AZ	1
	608-9278-001	2	RESISTOR KIT, (EFF CI 73076) (NON-PROCURABLE ITEM)	AY, BA, BB , BC, BD	1
	608-9278-001	2	RESISTOR KIT, (EFF CI 73046) (NON-PROCURABLE ITEM)	AZ	1
193	RCR07G122KS	3	RESISTOR, FXD, CMPSN, 1.2K, 10%, 1/4W (V81349) 745-0752-000 A5A1R69		AR
193	RCR07G152KS	3	RESISTOR, FXD, CMPSN, 1.5K, 10%, 1/4W (V81349) 745-0755-000 A5A1R69		AR
193	RCR07G182KS	3	RESISTOR, FXD, CMPSN, 1.8K, 10%, 1/4W (V81349) 745-0758-000 A5A1R59		AR
193	RCR07G222KS	3	RESISTOR, FXD, CMPSN, 2.2K, 10%, 1/4W (V81349) 745-0761-000 A5A1R69		AR
193	RCR07G272KS	3	RESISTOR, FXD, CMPSN, 2.7K, 10%, 1/4W (V81349) 745-0764-000 A5A1R69		AR
193	RCR07G332KS	3	RESISTOR, FXD, CMPSN, 3.3K, 10%, 1/4W (V81349) 745-0767-000 A5A1R69		AR
194	2C067103X0101A3	2	CAPACITOR, FXD, CER DIEL, 0.01UF, 20%, 100V (V56289) 913-4240-100 A5A1C57		1
195	DM5E270J050WV	2	CAPACITOR, FXD, MICA DIEL, 27PF, 5%, 50V (V72136) 912-4141-180 A5A1C67		1
196	RCR07G223KS	2	RESISTOR, FXD, CMPSN, 22K, 10%, 1/4W (V81349) 745-0797-000 A5A1R78		1
197	2C067103X0101A3	2	CAPACITOR, FXD, CER DIEL, 0.01UF, 20%, 100V (V56289) 913-4240-100 A5A1C66		1
198	2N4416	2	TRANSISTOR, (V17896) 352-0756-010 A5A1Q19		1
199	RCR07G152KS	2	RESISTOR, FXD, CMPSN, 1.5K, 10%, 1/4W (V81349) 745-0755-000 A5A1R77		1
200	RCR07G104KS	2	RESISTOR, FXD, CMPSN, 0.10MEGO, 10%, 1/4W (V81349) 745-0821-000 A5A1R76		1
201	2C067103X0101A3	2	CAPACITOR, FXD, CER DIEL, 0.01UF, 20%, 100V (V56289) 913-4240-100 A5A1C65		1
202	DM5F101J050WV	2	CAPACITOR, FXD, MICA DIEL, 100PF, 5%, 50V (V72136) 912-4141-050 A5A1C28		1
203	2N4416A	2	TRANSISTOR, (V17896) 352-0756-020 A5A1Q9		1
204	RCR07G100KS	2	RESISTOR, FXD, CMPSN, 10 OHMS, 10%, 1/4W (V81349) 745-0677-000 A5A1R35		1
205	D71F152J0	2	CAPACITOR, FXD, MICA DIEL, 1500PF, 5%, 100V (V00553) 912-2093-2A0 A5A1C30		1
206	RCR07G562KS	2	RESISTOR, FXD, CMPSN, 5.6K, 10%, 1/4W (V81349) 745-0776-000 A5A1R37 (EFF TO CI 72246)	AY	1

GROUP ASSEMBLY PARTS LIST

FIG - ITEM	PART NO	INDENT	DESCRIPTION	USABLE ON CODE	UNITS PER ASSY
19 206	RCR07G822KS	2	RESISTOR,FXD, CMPSN, 8.2K, 10%, 1/4W (V81349) 745-0782-000 A5A1R37 (EFF TO CI 72246)	AY	1
206	RCR07G822KS	2	RESISTOR,FXD, CMPSN, 8.2K, 10%, 1/4W (V81349) 745-0782-000 A5A1R37	AZ,BA,RB .BC,RD	1
207	D71F152JO	2	CAPACITOR,FXD, MICA DIEI, 1500PF, 5%, 100V (V00A53) 912-2093-2A0 A5A1C31		1
208	RCR07G100KS	2	RESISTOR,FXD, CMPSN, 10 OHMS, 10%, 1/4W (V81349) 745-0677-000 A5A1R36		1
209	RCR07G121KS	2	RESISTOR,FXD, CMPSN, 120 OHMS, 10%, 1/4W (V81349) 745-0716-000 A5A1R4		1
210	RCR07G101KS	2	RESISTOR,FXD, CMPSN, 100 OHMS, 10%, 1/4W (V81349) 745-0713-000 A5A1R8		1
211	2C067103X0101A3	2	CAPACITOR,FXD, CER DIEI, 0.01UF, 20%, 100V (V56289) 913-4240-100 A5A1C18		1
212	RCR07G560KS	2	RESISTOR,FXD, CMPSN, 56 OHMS, 10%, 1/4W (V81349) 745-0704-000 A5A1R3		1
213	1N459	2	SEMICONV DEVICE, (V07688) 353-0206-000 A5A1CR14		1
214	RCR07G121KS	2	RESISTOR,FXD, CMPSN, 120 OHMS, 10%, 1/4W (V81349) 745-0716-000 A5A1R2		1
215	2C067103X0101A3	2	CAPACITOR,FXD, CER DIEI, 0.01UF, 20%, 100V (V56289) 913-4240-100 A5A1C16		1
216	2C067103X0101A3	2	CAPACITOR,FXD, CER DIEI, 0.01UF, 20%, 100V (V56289) 913-4240-100 A5A1C12		1
217	RG196AU	2	CABLE,RF, (V80058) 425-1004-000		AR
218	141-1002-0002	2	CONNECTOR,RCPT, ELEC (V98278) 357-7353-010 A5A1P1		1
219	141-1002-0002	2	CONNECTOR,RCPT, ELEC (V98278) 357-7353-010 A5A1P2		1
220	141-1002-0002	2	CONNECTOR,RCPT, ELEC (V98278) 357-7353-010 A5A1P4		1
221	141-1002-0002	2	CONNECTOR,RCPT, ELEC (V98278) 357-7353-010 A5A1P5		1
222	793-9822-001	2	HOUSING,CONN		4
223	797-3514-001	2	HANDLE	AY	1
223	797-3514-006	2	HANDLE	AZ	1
223	797-3514-007	2	HANDLE	BA	1
223	797-3514-010	2	HANDLE	BB	1
223	797-3514-011	2	HANDLE	BC	1
223	797-3514-012	2	HANDLE	BD	1
	MS51923-314	2	PIN,SPRING, SST, 0.078 DIA X 1/4 (V96906) 311-0465-000 (AP)		1
224	372-2601-010	2	CONTACT,ELEC, 372-2601-010		2
225	372-2234-010	2	CONTACT,ELEC, (V13499) 372-2234-010		11
226	372-2234-020	2	CONTACT,ELEC, (V13499) 372-2234-020		10
227	372-2252-010	2	CONTACT,ELEC, 372-2252-010		31
228	372-2623-020	2	HOUSING,CONN,EL, 372-2623-020		1
229	372-2624-016	2	HOUSING,CONN, 372-2624-016		1
230	372-2625-016	2	HOUSING,CONN, 372-2625-016		1
231	372-2624-014	2	HOUSING,CONN, 372-2624-014		1
20 -	797-3585-002	1	CIRCUIT CARD ASSY,IF FILTER A5A2 (SEE FIG 1-20 FOR NHA)	BE	RF
-	797-3585-003	1	CIRCUIT CARD ASSY,IF FILTER A5A2 (SEE FIG 1-20 FOR NHA)	BF	RF
-	797-3585-010	1	CIRCUIT CARD ASSY,IF FILTER A5A2 (SEE FIG 1-20 FOR NHA)	BG	RF



GROUP ASSEMBLY PARTS LIST

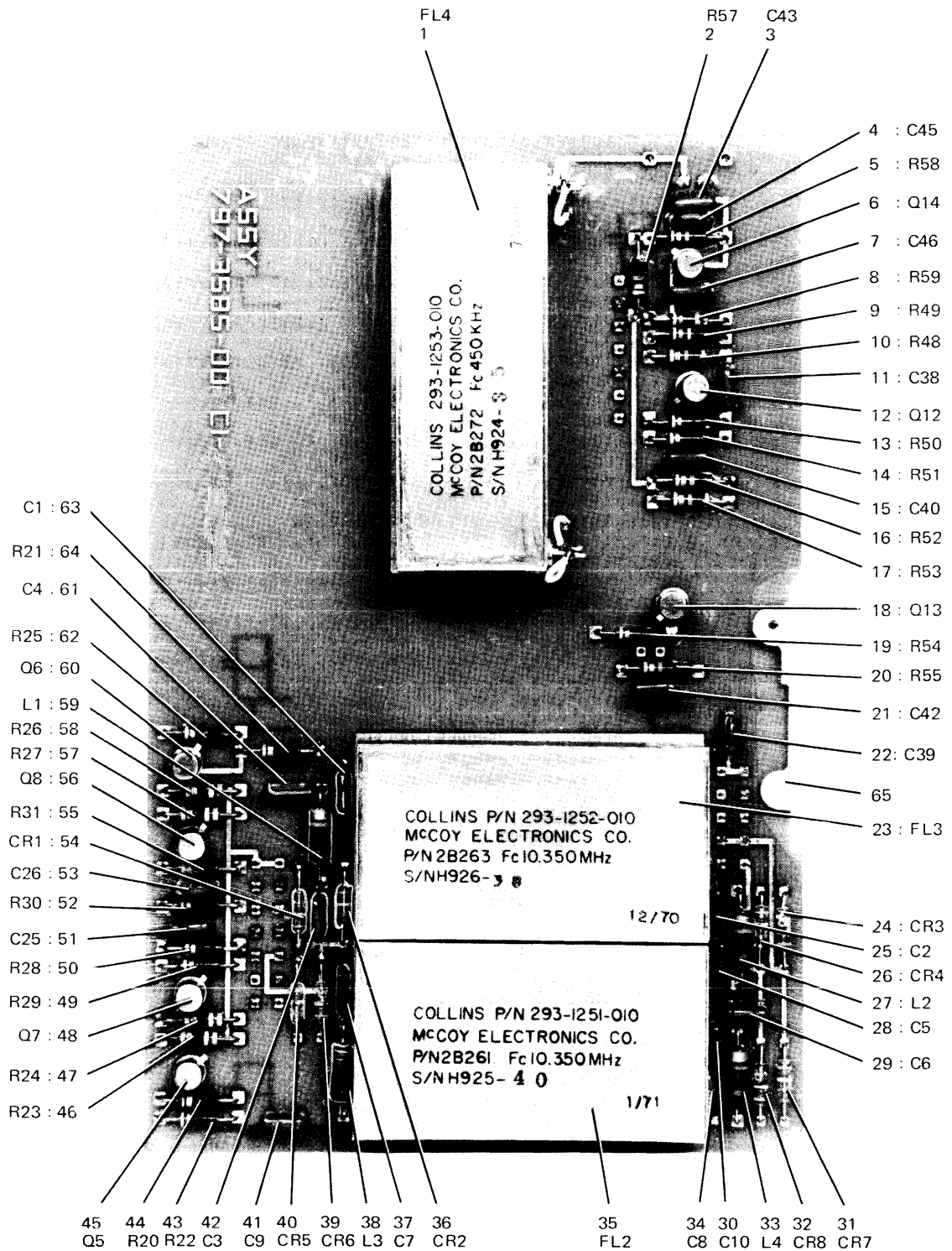

TP3-1035-017

IF Filter Circuit Card Assembly (A5A2) 797-3585-002, -003, -010, -011, -012  
Figure 20

GROUP ASSEMBLY PARTS LIST

FIG - ITEM	PART NO	INDENT	DESCRIPTION	USABLE ON CODE	UNITS PER ASSY
20	797-3585-011	1	CIRCUIT CARD ASSY, IF FILTER A5A2 (SEE FIG 1-20 FOR NHA)	BH	RF
-	797-3585-012	1	CIRCUIT CARD ASSY, IF FILTER A5A2 (SEE FIG 1-20 FOR NHA)	RJ	RF
1	2B253	2	FILTER, BP, XTAL, (V00136) 293-1265-010 A5A2FL4	BE, BG	1
1	2B272	2	FILTER, XTAL, (V00136) 293-1253-010 A5A2FL4	BF	1
1	2B293	2	FILTER, XTAL, (V00136) 293-1268-010 A5A2FL4	BH	1
	MS51957-14	2	SCREW, MACH, STL, 4-40 X 5/16 (V96906) 343-0134-000 (AP)	BE, BF, BH	2
	MS51957-13	2	SCREW, MACH, STL, 4-40 X 1/4 (V96906) 343-0133-000 (AP)	BG	2
	310-0278-000	2	WASHER, LOCK, SST, 0.115 ID X 0.202 OD (V70318) 310-0278-000 (AP)	BE, BF, BG, BH	2
	310-0045-000	2	WASHER, FLAT, SST, 0.125 ID X 0.312 OD (V79807) 310-0045-000 (AP)	BE, BF, BH	2
	310-6340-000	2	WASHER, FLAT, SST, 0.125 ID X 0.281 OD (V79807) 310-6340-000 (AP)	BG	2
2	RCR07G103KS	2	RESISTOR, FXD, CMPSN, 10K, 10%, 1/4W (V81349) 745-0785-000 A5A2R57		1
3	2C067103X0101A3	2	CAPACITOR, FXD, CER DIEL, 0.01UF, 20%, 100V (V56289) 913-4240-100 A5A2C43		1
4	2C067103X0101A3	2	CAPACITOR, FXD, CER DIEL, 0.01UF, 20%, 100V (V56289) 913-4240-100 A5A2C45		1
5	RCR07G223KS	2	RESISTOR, FXD, CMPSN, 22K, 10%, 1/4W (V81349) 745-0797-000 A5A2R58		1
6	352-0756-011	2	TRANSISTOR, 352-0756-011 A5A2Q14		1
7	2C067103X0101A3	2	CAPACITOR, FXD, CER DIEL, 0.01UF, 20%, 100V (V56289) 913-4240-100 A5A2C46		1
8	RCR07G331KS	2	RESISTOR, FXD, CMPSN, 330 OHMS, 10%, 1/4W (V81349) 745-0731-000 A5A2R59		1
9	RCR07G104KS	2	RESISTOR, FXD, CMPSN, 0.10MEGO, 10%, 1/4W (V81349) 745-0821-000 A5A2R49		1
10	RCR07G473KS	2	RESISTOR, FXD, CMPSN, 47K, 10%, 1/4W (V81349) 745-0809-000 A5A2R48		1
11	2C067103X0101A3	2	CAPACITOR, FXD, CER DIEL, 0.01UF, 20%, 100V (V56289) 913-4240-100 A5A2C38		1
12	2N2907	2	TRANSISTOR, (V07688) 352-0551-000 A5A2Q12		1
13	RCR07G222KS	2	RESISTOR, FXD, CMPSN, 2.2K, 10%, 1/4W (V81349) 745-0761-000 A5A2R50		1
14	RCR07G222KS	2	RESISTOR, FXD, CMPSN, 2.2K, 10%, 1/4W (V81349) 745-0761-000 A5A2R51		1
15	2C067103X0101A3	2	CAPACITOR, FXD, CER DIEL, 0.01UF, 20%, 100V (V56289) 913-4240-100 A5A2C40		1
16	RCR07G103KS	2	RESISTOR, FXD, CMPSN, 10K, 10%, 1/4W (V81349) 745-0785-000 A5A2R52		1
17	RCR07G473KS	2	RESISTOR, FXD, CMPSN, 47K, 10%, 1/4W (V81349) 745-0809-000 A5A2R53		1
18	352-0756-011	2	TRANSISTOR, 352-0756-011 A5A2Q13		1
19	RCR07G152KS	2	RESISTOR, FXD, CMPSN, 1.5K, 10%, 1/4W (V81349) 745-0755-000 A5A2R54		1
20	RCR07G223KS	2	RESISTOR, FXD, CMPSN, 22K, 10%, 1/4W (V81349) 745-0797-000 A5A2R55		1
21	2C067103X0101A3	2	CAPACITOR, FXD, CER DIEL, 0.01UF, 20%, 100V (V56289) 913-4240-100 A5A2C42		1
22	K05SK102M	2	CAPACITOR, FXD, CER DIEL, 1000PF, 10%, 100V (V05397) 913-4489-360 A5A2C39		1
23	2B263	2	FILTER, XTAL, (V00136) 293-1252-010 A5A2FL3	BF, BG, BH	1
	P313-0132-000	2	NUT, PLAIN, HEX, SST, 4-40 (V77250) 313-0132-000 (AP)	BJ	2
	310-0278-000	2	WASHER, LOCK, SST, 0.115 ID X 0.202 OD (V70318) 310-0278-000 (AP)	BF, BG, BH, BJ	2
	310-0045-000	2	WASHER, FLAT, SST, 0.125 ID X 0.312 OD (V79807) 310-0045-000 (AP)	BF, BG, BH, BJ	2

## GROUP ASSEMBLY PARTS LIST

FIG - ITEM	PART NO	INDENT	DESCRIPTION	USABLE ON CODE	UNITS PER ASSY
20	310-6340-000	2	WASHER, FLAT, SST, 0.125 ID X 0.281 OD (V79807) 310-6340-000 (AP)	BG	2
24	1N459	2	SEMICONV DEVICE, (V07688) 353-0206-000 A5A2CR3		1
25	2C067103X0101A3	2	CAPACITOR, FXD, CER DIEI, 0.01UF, 20%, 100V (V56289) 913-4240-100 A5A2C2		1
26	1N459	2	SEMICONV DEVICE, (V07688) 353-0206-000 A5A2CR4		1
27	M990538-04	2	COIL, RF, 47UH (V96906) 240-2508-000 A5A2L2		1
28	2C067103X0101A3	2	CAPACITOR, FXD, CER DIEI, 0.01UF, 20%, 100V (V56289) 913-4240-100 A5A2C5		1
29	2C067103X0101A3	2	CAPACITOR, FXD, CER DIEI, 0.01UF, 20%, 100V (V56289) 913-4240-100 A5A2C6		1
30	2C067103X0101A3	2	CAPACITOR, FXD, CER DIEI, 0.01UF, 20%, 100V (V56289) 913-4240-100 A5A2C10		1
31	1N459	2	SEMICONV DEVICE, (V07688) 353-0206-000 A5A2CR7		1
32	1N459	2	SEMICONV DEVICE, (V07688) 353-0206-000 A5A2CR8		1
33	M990538-04	2	COIL, RF, 47UH (V96906) 240-2508-000 A5A2L4		1
34	2C067103X0101A3	2	CAPACITOR, FXD, CER DIEI, 0.01UF, 20%, 100V (V56289) 913-4240-100 A5A2C8		1
35	2B252	2	FILTER, BP, XTAL, (V00136) 293-1266-010 A5A2FL2	BE, BG	1
35	2B261	2	FILTER, XTAL, (V00136) 293-1251-010 A5A2FL2	BF	1
35	293-1252-020	2	FILTER, XTAL, (V00136) 293-1252-020 A5A2FL2	BH	1
35	293-1266-020	2	FILTER, BP, XTAL, (V00136) 293-1266-020 A5A2FL2	BJ	1
	P313-0132-000	2	NUT, PLAIN, HEX, SST, 4-40 (V77250) 313-0132-000 (AP)		2
	310-0278-000	2	WASHER, LOCK, SST, 0.115 ID X 0.202 OD (V70318) 310-0278-000 (AP)		2
	310-0045-000	2	WASHER, FLAT, SST, 0.125 ID X 0.312 OD (V79807) 310-0045-000 (AP)	BE, BF, BH , BJ	2
	310-6340-000	2	WASHER, FLAT, SST, 0.125 ID X 0.281 OD (V79807) 310-6340-000 (AP)	BG	2
36	1N459	2	SEMICONV DEVICE, (V07688) 353-0206-000 A5A2CR2		1
37	2C067103X0101A3	2	CAPACITOR, FXD, CER DIEI, 0.01UF, 20%, 100V (V56289) 913-4240-100 A5A2C7		1
38	M990538-04	2	COIL, RF, 47UH (V96906) 240-2508-000 A5A2L3		1
39	1N459	2	SEMICONV DEVICE, (V07688) 353-0206-000 A5A2CR6		1
40	1N459	2	SEMICONV DEVICE, (V07688) 353-0206-000 A5A2CR5		1
41	2C067103X0101A3	2	CAPACITOR, FXD, CER DIEI, 0.01UF, 20%, 100V (V56289) 913-4240-100 A5A2C9		1
42	2C067103X0101A3	2	CAPACITOR, FXD, CER DIEI, 0.01UF, 20%, 100V (V56289) 913-4240-100 A5A2C3		1
43	RCR07G222KS	2	RESISTOR, FXD, CMPSN, 2.2K, 10%, 1/4W (V81349) 745-0761-000 A5A2R22		1
44	RCR07G101KS	2	RESISTOR, FXD, CMPSN, 100 OHMS, 10%, 1/4W (V81349) 745-0713-000 A5A2R20		1
45	2N2907	2	TRANSISTOR, (V07688) 352-0551-000 A5A205		1
46	RCR07G392KS	2	RESISTOR, FXD, CMPSN, 3.9K, 10%, 1/4W (V81349) 745-0770-000 A5A2R23		1
47	RCR07G392KS	2	RESISTOR, FXD, CMPSN, 3.9K, 10%, 1/4W (V81349) 745-0770-000 A5A2R24		1
48	2N2222A	2	TRANSISTOR, (V81350) 352-7500-280 A5A207		1
49	RCR07G152KS	2	RESISTOR, FXD, CMPSN, 1.5K, 10%, 1/4W (V81349) 745-0755-000 A5A2R29		1
50	RCR07G222KS	2	RESISTOR, FXD, CMPSN, 2.2K, 10%, 1/4W (V81349) 745-0761-000 A5A2R28		1
51	2C067103X0101A3	2	CAPACITOR, FXD, CER DIEI, 0.01UF, 20%, 100V (V56289) 913-4240-100 A5A2C25		1
52	RCR07G222KS	2	RESISTOR, FXD, CMPSN, 2.2K, 10%, 1/4W (V81349) 745-0761-000 A5A2R30		1
53	2C067103X0101A3	2	CAPACITOR, FXD, CER DIEI, 0.01UF, 20%, 100V (V56289) 913-4240-100 A5A2C26		1
54	1N459	2	SEMICONV DEVICE, (V07688) 353-0206-000 A5A2CR1		1
55	RCR07G152KS	2	RESISTOR, FXD, CMPSN, 1.5K, 10%, 1/4W (V81349) 745-0755-000 A5A2R31		1

GROUP ASSEMBLY PARTS LIST

FIG - ITEM	PART NO	INDENT	DESCRIPTION	USABLE ON CODE	UNITS PER ASSY
20	56	2N2222A	2 TRANSISTOR, (V81350) 352-7500-280 A5A2Q8		1
	57	RCR07G392KS	2 RESISTOR,FXD, CMPSN, 3.9K, 10%, 1/4W (V81349) 745-0770-000 A5A2R27		1
	58	RCR07G392KS	2 RESISTOR,FXD, CMPSN, 3.9K, 10%, 1/4W (V81349) 745-0770-000 A5A2R26		1
	59	MS90538-04	2 COIL,RF, 47UH (V96906) 240-2508-000 A5A2L1		1
	60	2N2907	2 TRANSISTOR, (V07688) 352-0551-000 A5A2Q6		1
	61	2C067103X0101A3	2 CAPACITOR,FXD, CER DIEL, 0.01uF, 20%, 100V (V56289) 913-4240-100 A5A2C4		1
	62	RCR07G222KS	2 RESISTOR,FXD, CMPSN, 2.2K, 10%, 1/4W (V81349) 745-0761-000 A5A2R25		1
	63	2C067103X0101A3	2 CAPACITOR,FXD, CER DIEL, 0.01uF, 20%, 100V (V56289) 913-4240-100 A5A2C1		1
	64	RCR07G101KS	2 RESISTOR,FXD, CMPSN, 100 OHMS, 10%, 1/4W (V81349) 745-0713-000 A5A2R21		1
	65	609-0925-001	2 HANDLE	BE	1
	65	609-0925-002	2 HANDLE	BF	1
	65	609-0925-010	2 HANDLE	BG	1
	65	609-0925-011	2 HANDLE	BH	1
	65	609-0925-012	2 HANDLE	BJ	1
		MS51923-314	2 PIN,SPRING, SST, 0.078 DIA X 1/4 (V96906) 311-0465-000 (AP)		1
	66	372-2601-037	2 CONTACT,ELEC, 372-2601-037		31

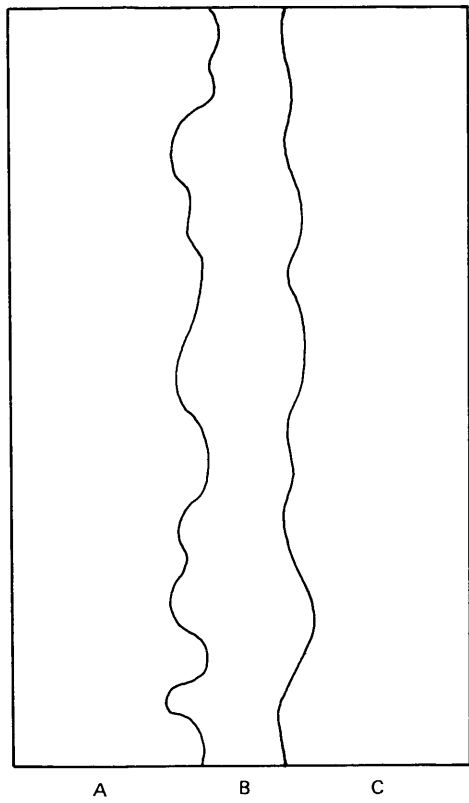

TP3-1036-047

IF Amplifier Circuit Card Assembly (A4) 778-2951-001, -003, -004  
Figure 21 (Sheet 1 of 4)

GROUP ASSEMBLY PARTS LIST

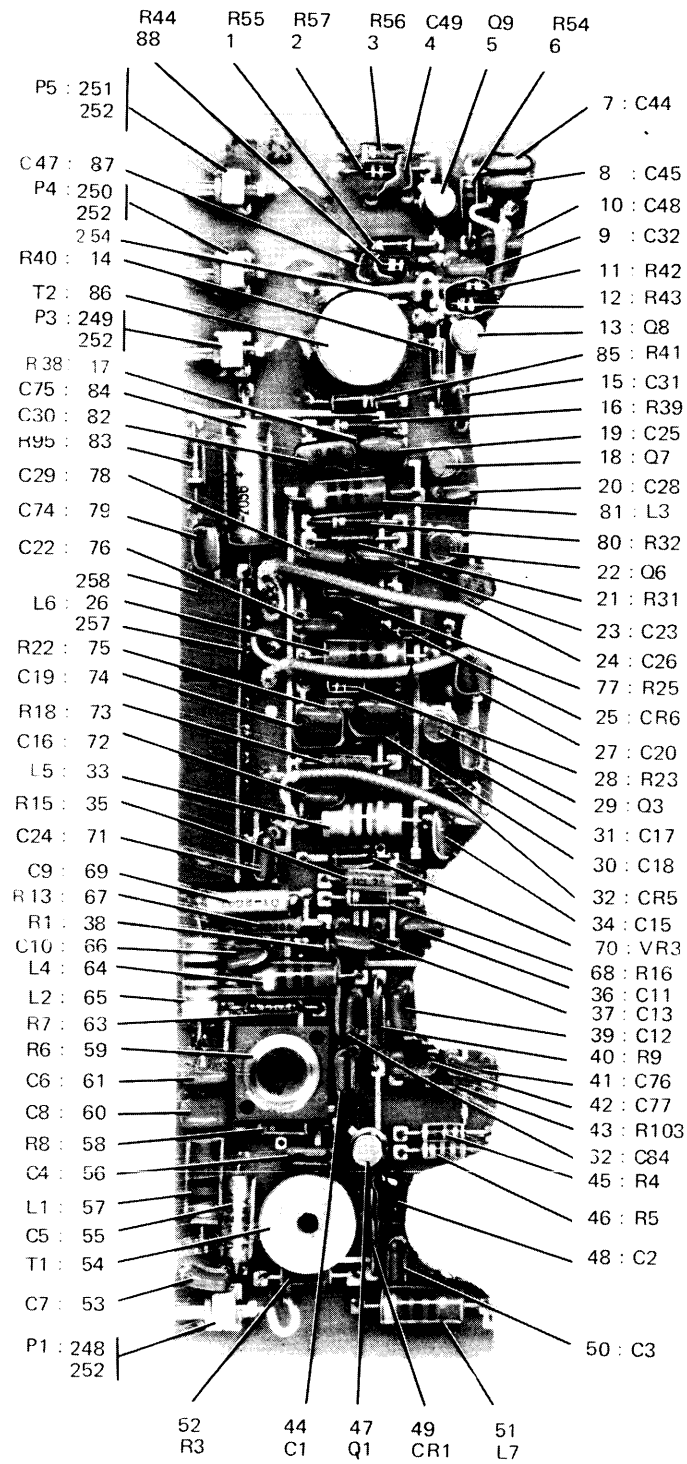

TP3-1036-047

IF Amplifier Circuit Card Assembly (A4) 778-2951-001, -003, -004  
Figure 21 (Sheet 2 of 4)

Revised 1 October 1972

GROUP ASSEMBLY PARTS LIST

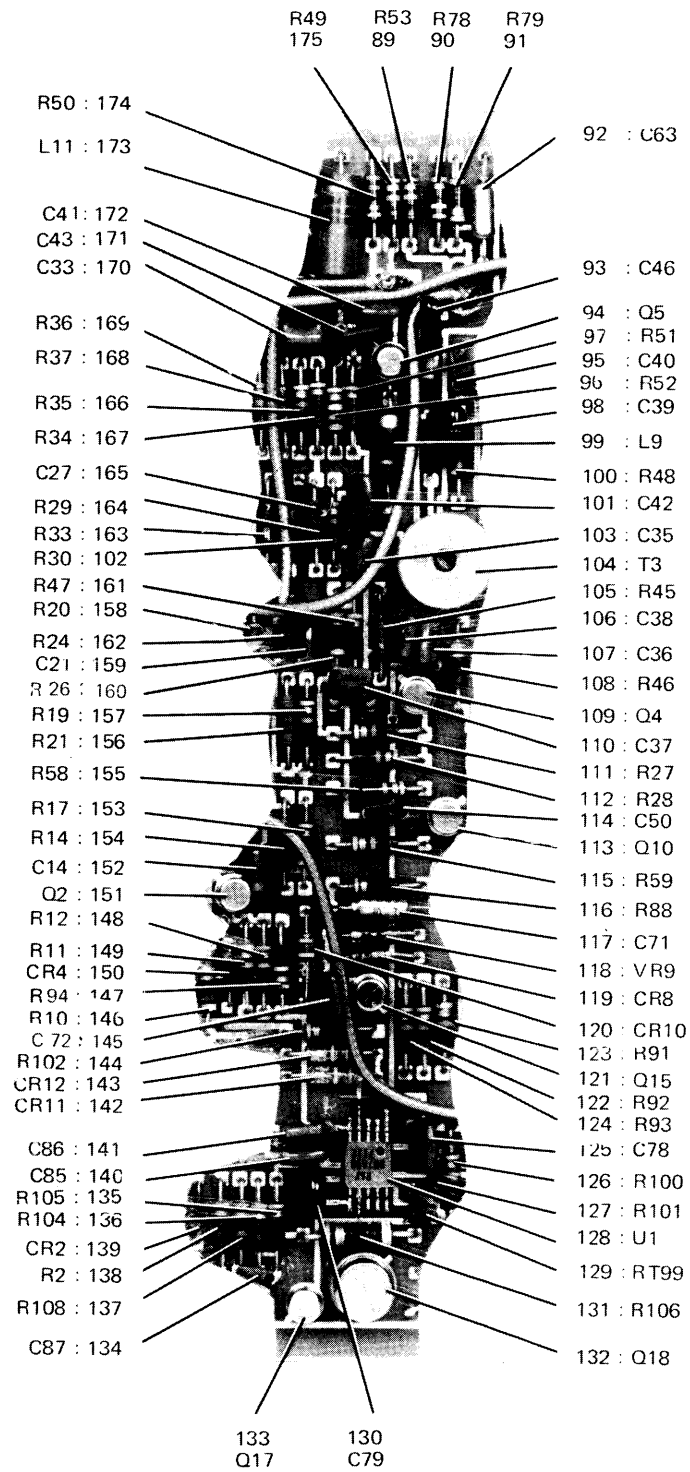

TP3-1036-047

IF Amplifier Circuit Card Assembly (A4) 778-2951-001, -003, -004  
Figure 21 (Sheet 3 of 4)

GROUP ASSEMBLY PARTS LIST

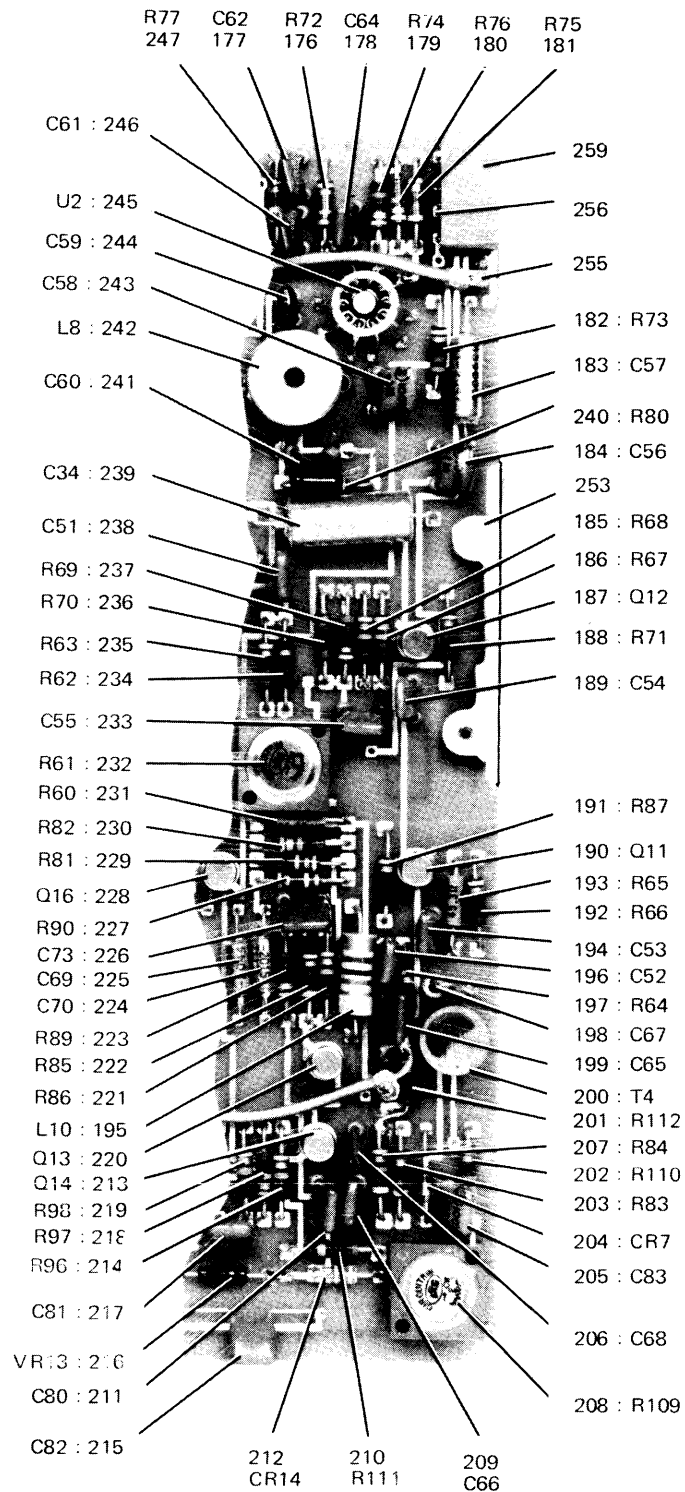

TP3-1036-047

IF Amplifier Circuit Card Assembly (A4) 778-2951-001, -003, -004  
Figure 21 (Sheet 4 of 4)

GROUP ASSEMBLY PARTS LIST

FIG - ITEM	PART NO	INDENT	DESCRIPTION	USABLE ON CODE	UNITS PER ASSY
21 -	778-2951-001	1	CIRCUIT CARD ASSY, 1F AMPLIFIER A4 (SEE FIG 1-21 FOR NHA)	BK	RF
-	778-2951-003	1	CIRCUIT CARD ASSY, 1F AMPLIFIER A4 (SEE FIG 1-21 FOR NHA)	RL	RF
-	778-2951-004	1	CIRCUIT CARD ASSY, 1F AMPLIFIER A4 (SEE FIG 1-21 FOR NHA)	BM	RF
1	RCR07G472KS	2	RESISTOR,FXD, CMPSN, 4.7K, 10%, 1/4W (V81349) 745-0773-000 A4R55		1
2	RCR07G471KS	2	RESISTOR,FXD, CMPSN, 470 OHMS, 10%, 1/4W (V81349) 745-0737-000 A4R57		1
3	RCR07G101KS	2	RESISTOR,FXD, CMPSN, 100 OHMS, 10%, 1/4W (V81349) 745-0713-000 A4R56		1
4	2C067103X0101A3	2	CAPACITOR,FXD, CER DIEL, 0.01UF, 20%, 100V (V56289) 913-4240-100 A4C49		1
5	2N2222A	2	TRANSISTOR, (V81350) 352-7500-280 A4Q9		1
6	RCR07G153KS	2	RESISTOR,FXD, CMPSN, 15K, 10%, 1/4W (V81349) 745-0791-000 A4R54		1
7	2C067332X0101A3	2	CAPACITOR,FXD, CER DIEL, 0.0033UF, 20%, 100V (V56289) 913-4240-150 A4C44		1
8	8131-050-651-104 M	2	CAPACITOR,FXD, CER DIEL, 0.1UF, 20%, 50V (V72982) 913-3279-200 A4C45		1
9	8131-050-651-104 M	2	CAPACITOR,FXD, CER DIEL, 0.1UF, 20%, 50V (V72982) 913-3279-200 A4C32		1
10	2C067103X0101A3	2	CAPACITOR,FXD, CER DIEL, 0.01UF, 20%, 100V (V56289) 913-4240-100 A4C48		1
11	RCR07G471KS	2	RESISTOR,FXD, CMPSN, 470 OHMS, 10%, 1/4W (V81349) 745-0737-000 A4R42		1
12	RCR07G470KS	2	RESISTOR,FXD, CMPSN, 47 OHMS, 10%, 1/4W (V81349) 745-0701-000 A4R43		1
13	2N2222A	2	TRANSISTOR, (V81350) 352-7500-280 A4Q8		1
14	RCR07G472KS	2	RESISTOR,FXD, CMPSN, 4.7K, 10%, 1/4W (V81349) 745-0773-000 A4R40		1
15	K059K102M	2	CAPACITOR,FXD, CER DIEL, 1000PF, 10%, 100V (V05397) 913-4489-360 A4C31		1
16	RCR07G122KS	2	RESISTOR,FXD, CMPSN, 1.2K, 10%, 1/4W (V81349) 745-0752-000 A4R39		1
17	T055-61-9-1F	2	RESISTOR,FXD, FILM, 61.9 OHMS, 1%, 1/8W (V11502) 705-1454-100 A4R38		1
18	2N2222A	2	TRANSISTOR, (V81350) 352-7500-280 A4Q7		1
19	8131-050-651-104 M	2	CAPACITOR,FXD, CER DIEL, 0.1UF, 20%, 50V (V72982) 913-3279-200 A4C25		1
20	K059K102M	2	CAPACITOR,FXD, CER DIEL, 1000PF, 10%, 100V (V05397) 913-4489-360 A4C28		1
21	T055-61-9-1F	2	RESISTOR,FXD, FILM, 61.9 OHMS, 1%, 1/8W (V11502) 705-1454-100 A4R31		1
22	2N2222A	2	TRANSISTOR, (V81350) 352-7500-280 A4Q6		1
23	8131-050-651-104 M	2	CAPACITOR,FXD, CER DIEL, 0.1UF, 20%, 50V (V72982) 913-3279-200 A4C23		1
24	2C067472X0101A3	2	CAPACITOR,FXD, CER DIEL, 0.0047UF, 20%, 100V (V56289) 913-4240-110 A4C26		1
25	1N5767	2	SEMICOND DEVICE, (V07688) 922-6119-010 A4CR6		1
26	MS90539-15	2	COIL,RF, 1000UH (V96906) 240-2540-000 A4L6		1
27	2C067472X0101A3	2	CAPACITOR,FXD, CER DIEL, 0.0047UF, 20%, 100V (V56289) 913-4240-110 A4C20		1
28	RCR07G122KS	2	RESISTOR,FXD, CMPSN, 1.2K, 10%, 1/4W (V81349) 745-0752-000 A4R23		1
29	2N2222A	2	TRANSISTOR, (V81350) 352-7500-280 A4Q3		1
30	8131-050-651-104 M	2	CAPACITOR,FXD, CER DIEL, 0.1UF, 20%, 50V (V72982) 913-3279-200 A4C18		1
31	2C067472X0101A3	2	CAPACITOR,FXD, CER DIEL, 0.0047UF, 20%, 100V (V56289) 913-4240-110 A4C17		1
32	1N5767	2	SEMICOND DEVICE, (V07688) 922-6119-010 A4CR5		1
33	MS90539-15	2	COIL,RF, 1000UH (V96906) 240-2540-000 A4L5		1



## GROUP ASSEMBLY PARTS LIST

FIG - ITEM	PART NO	INDENT	DESCRIPTION	USABLE ON CODE	UNITS PER ASSY
21 34	2C067472X0101A3	2	CAPACITOR,FXD, CER DIEI, 0.0047UF, 20%, 100V (V56289) 913-4240-110 A4C15		1
35	T055-86R6-1F	2	RESISTOR,FXD, FILM, 86.6 OHMS, 1%, 1/8W (V11502) 705-1470-350 A4R15		1
36	2C067472X0101A3	2	CAPACITOR,FXD, CER DIEI, 0.0047UF, 20%, 100V (V56289) 913-4240-110 A4C11		1
37	8131-050-651-104 M	2	CAPACITOR,FXD, CER DIEI, 0.1UF, 20%, 50V (V72982) 913-3279-200 A4C13		1
38	RCR07G102JS	2	RESISTOR,FXD, CMPSN, 1K, 5%, 1/4W (V81349) 745-0748-000 A4R1		1
39	8131-050-651-104 M	2	CAPACITOR,FXD, CER DIEI, 0.1UF, 20%, 50V (V72982) 913-3279-200 A4C12		1
40	55D2670F	2	RESISTOR,FXD, FILM, 267 OHMS, 1%, 1/8W (V96214) 705-1469-670 A4R9		1
41	2C067103X0101A3	2	CAPACITOR,FXD, CER DIEI, 0.01UF, 20%, 100V (V56289) 913-4240-100 A4C76	RK,BM	1
42	2C067103X0101A3	2	CAPACITOR,FXD, CER DIEI, 0.01UF, 20%, 100V (V56289) 913-4240-100 A4C77		1
43	RCR07G222KS	2	RESISTOR,FXD, CMPSN, 2.2K, 10%, 1/4W (V81349) 745-0761-000 A4R103		1
44	8131-050-651-104 M	2	CAPACITOR,FXD, CER DIEI, 0.1UF, 20%, 50V (V72982) 913-3279-200 A4C1		1
45	RCR07G473KS	2	RESISTOR,FXD, CMPSN, 47K, 10%, 1/4W (V81349) 745-0809-000 A4R4		1
46	RCR07G333KS	2	RESISTOR,FXD, CMPSN, 33K, 10%, 1/4W (V81349) 745-0803-000 A4R5		1
47	2N2222A	2	TRANSISTOR, (V81350) 352-7500-280 A4Q1		1
48	D71F152J0	2	CAPACITOR,FXD, MICA DIEI, 1500PF, 5%, 100V (V00A53) 912-2093-280 A4C2		1
49	1N4003	2	SEMICONV DEVICE, (V04713) 353-6442-030 A4CR1		1
50	2C067103X0101A3	2	CAPACITOR,FXD, CER DIEI, 0.01UF, 20%, 100V (V56289) 913-4240-100 A4C3		1
51	MS90539-15	2	COIL,RF, 1000UH (V96906) 240-2540-000 A4L7		1
52	T055-11800-1F	2	RESISTOR,FXD, FILM, 11.8K, 1%, 1/8W (V11502) 705-1468-450 A4R3		1
53	8131-050-651-104 M	2	CAPACITOR,FXD, CER DIEI, 0.1UF, 20%, 50V (V72982) 913-3279-200 A4C7		1
54	A264	2	TRANSFORMER,VAR, (V81815) 278-0383-010 A4T1		1
55	M39003-01-2029	2	CAPACITOR,FXD, ELCTLT, 3.3UF, 20%, 15V (V81349) 184-9083-290 A4C5	BK,BM	1
56	2C067472X0101A3	2	CAPACITOR,FXD, CER DIEI, 0.0047UF, 20%, 100V (V56289) 913-4240-110 A4C4		1
57	MS90539-15	2	COIL,RF, 1000UH (V96906) 240-2540-000 A4L1		1
58	RCR07G122KS	2	RESISTOR,FXD, CMPSN, 1.2K, 10%, 1/4W (V81349) 745-0752-000 A4R8		1
59	RT22C2P101	2	RESISTOR,VAR,WW, 100 OHMS, 5%, 3/4W (V81349) 381-1721-010 A4R6		1
60	8131-050-651-104 M	2	CAPACITOR,FXD, CER DIEI, 0.1UF, 20%, 50V (V72982) 913-3279-200 A4C8		1
61	8131-050-651-104 M	2	CAPACITOR,FXD, CER DIEI, 0.1UF, 20%, 50V (V72982) 913-3279-200 A4C6		1
62	2C067472X0101A3	2	CAPACITOR,FXD, CER DIEI, 0.0047UF, 20%, 100V (V56289) 913-4240-110 A4C84		1
63	55D32R4F	2	RESISTOR,FXD, FILM, 32.4 OHMS, 1%, 1/8W (V96214) 705-1469-230 A4R7 (EFF TO CI 72473)		1
63	RCR07G150KS	2	RESISTOR,FXD, CMPSN, 15 OHMS, 10%, 1/4W (V81349) 745-0683-000 A4R7 (EFF CI 72473)		1
64	MS90539-15	2	COIL,RF, 1000UH (V96906) 240-2540-000 A4L4		1
65	MS90539-15	2	COIL,RF, 1000UH (V96906) 240-2540-000 A4L2		1
66	2C067103X0101A3	2	CAPACITOR,FXD, CER DIEI, 0.01UF, 20%, 100V (V56289) 913-4240-100 A4C10		1
67	T055-4021-1F	2	RESISTOR,FXD, FILM, 4.02K, 1%, 1/8W (V11502) 705-1470-770 A4R13		1

GROUP ASSEMBLY PARTS LIST

FIG - ITEM	PART NO	INDENT	DESCRIPTION	USABLE ON CODE	UNITS PER ASSY
21 68	RCR07G122KS	2	RESISTOR,FXD, CMPSN, 1.2K, 10%, 1/4W (V81349) 745-0752-000 A4R16		1
69	M39003-01-2047	2	CAPACITOR,FXD, ELCTLT, 10UF, 20%, 20V (V81349) 184-9083-470 A4C9	BK,BM	1
70	1N746A	2	SEMICOND DEVICE, (V81350) 353-2973-000 A4VR3		1
71	8131-050-651-104 M	2	CAPACITOR,FXD, CER DIEL, 0.1UF, 20%, 50V (V72982) 913-3279-200 A4C24		1
72	2C067103X0101A3	2	CAPACITOR,FXD, CER DIEL, 0.01UF, 20%, 100V (V56289) 913-4240-100 A4C16		1
73	T055-4021-1F	2	RESISTOR,FXD, FILM, 4.02K, 1%, 1/8W (V11502) 705-1470-770 A4R18		1
74	8131-050-651-104 M	2	CAPACITOR,FXD, CER DIEL, 0.1UF, 20%, 50V (V72982) 913-3279-200 A4C19		1
75	T055-86R6-1F	2	RESISTOR,FXD, FILM, 86.6 OHMS, 1%, 1/8W (V11502) 705-1470-350 A4R22 (EFF TO CI 72373)		1
75	997F18	2	RESISTOR,THRM, 100 OHMS, 10%, 0.5W (V10646) 714-1723-000 A4RT22 (EFF CI 72373)		1
76	2C067103X0101A3	2	CAPACITOR,FXD, CER DIEL, 0.01UF, 20%, 100V (V56289) 913-4240-100 A4C22		1
77	T055-4021-1F	2	RESISTOR,FXD, FILM, 4.02K, 1%, 1/8W (V11502) 705-1470-770 A4R25		1
78	8131-050-651-104 M	2	CAPACITOR,FXD, CER DIEL, 0.1UF, 20%, 50V (V72982) 913-3279-200 A4C29		1
79	8131-050-651-104 M	2	CAPACITOR,FXD, CER DIEL, 0.1UF, 20%, 50V (V72982) 913-3279-200 A4C74	BK,BM	1
79	2C067103X0101A3	2	CAPACITOR,FXD, CER DIEL, 0.01UF, 20%, 100V (V56289) 913-4240-100 A4C74	RL	1
80	RCR07G122KS	2	RESISTOR,FXD, CMPSN, 1.2K, 10%, 1/4W (V81349) 745-0752-000 A4R32		1
81	MS90539-15	2	COIL,RF, 1000UH (V96906) 240-2540-000 A4L3		1
82	8131-050-651-104 M	2	CAPACITOR,FXD, CER DIEL, 0.1UF, 20%, 50V (V72982) 913-3279-200 A4C30		1
83	RCR07G102JS	2	RESISTOR,FXD, CMPSN, 1K, 5%, 1/4W (V81349) 745-0748-000 A4R95	BK,BM	1
83	RCR07G100KS	2	RESISTOR,FXD, CMPSN, 10 OHMS, 10%, 1/4W (V81349) 745-0677-000 A4R95	BL	1
84	M39003-01-2056	2	CAPACITOR,FXD, ELCTLT, 47UF, 20%, 20V (V81349) 184-9083-560 A4C75	BK,BM	1
85	RCR07G272KS	2	RESISTOR,FXD, CMPSN, 2.7K, 10%, 1/4W (V81349) 745-0764-000 A4R41		1
86	A265	2	TRANSFORMER,RF, (V81815) 278-0384-010 A4T2		1
87	8131-050-651-104 M	2	CAPACITOR,FXD, CER DIEL, 0.1UF, 20%, 50V (V72982) 913-3279-200 A4C47		1
88	RCR07G102JS	2	RESISTOR,FXD, CMPSN, 1K, 5%, 1/4W (V81349) 745-0748-000 A4R44		1
89	RCR07G103KS	2	RESISTOR,FXD, CMPSN, 10K, 10%, 1/4W (V81349) 745-0785-000 A4R53		1
90	RCR07G392KS	2	RESISTOR,FXD, CMPSN, 3.9K, 10%, 1/4W (V81349) 745-0770-000 A4R78	BK,BL	1
91	RCR07G472KS	2	RESISTOR,FXD, CMPSN, 4.7K, 10%, 1/4W (V81349) 745-0773-000 A4R79	BK,BL	1
92	150D105X0035A2	2	CAPACITOR,FXD, ELCTLT, 1UF, 20%, 35V (V56289) 184-7398-000 A4C83	BK,BL	1
93	D71F621J0	2	CAPACITOR,FXD, MICA DIEL, 620PF, 5%, 100V (V00853) 912-2093-190 A4C46		1
94	JN141	2	TRANSISTOR, (V07688) 352-0867-020 A4Q5		1
95	K059K102M	2	CAPACITOR,FXD, CER DIEL, 1000PF, 10%, 100V (V05397) 913-4489-360 A4C40		1
96	RCR07G334KS	2	RESISTOR,FXD, CMPSN, 0.33MEGO, 10%, 1/4W (V81349) 745-0839-000 A4R52		1
97	RCR07G272KS	2	RESISTOR,FXD, CMPSN, 2.7K, 10%, 1/4W (V81349) 745-0764-000 A4R51		1

## GROUP ASSEMBLY PARTS LIST

FIG - ITEM	PART NO	INDENT	DESCRIPTION	USABLE ON CODE	UNITS PER ASSY
21 98	D71F821J0	2	CAPACITOR,FXD, MICA DIEI, 820PF, 5%, 100V (V00453) 912-2093-220 A4C39		1
99	MS90537-41	2	COIL,RF, 220UH (V96906) 240-2715-410 A4L9		1
100	RCR07G682KS	2	RESISTOR,FXD, CMPSN, 6.8K, 10%, 1/4W (V81349) 745-0779-000 A4R48		1
101	8131-050-651-104 M	2	CAPACITOR,FXD, CER DIEI, 0.1UF, 20%, 50V (V72982) 913-3279-200 A4C42		1
102	RCR07G103KS	2	RESISTOR,FXD, CMPSN, 10K, 10%, 1/4W (V81349) 745-0785-000 A4R30		1
103	8131-050-651-104 M	2	CAPACITOR,FXD, CER DIEI, 0.1UF, 20%, 50V (V72982) 913-3279-200 A4C35		1
104	A249	2	TRANSFORMER,RF, (V81815) 278-0386-010 A4T3		1
105	T055-78R7-1F	2	RESISTOR,FXD, FILM, 78.7 OHMS, 1%, 1/8W (V11502) 705-1470-340 A4R45		1
106	8131-050-651-104 M	2	CAPACITOR,FXD, CER DIEI, 0.1UF, 20%, 50V (V72982) 913-3279-200 A4C38		1
107	8131-050-651-104 M	2	CAPACITOR,FXD, CER DIEI, 0.1UF, 20%, 50V (V72982) 913-3279-200 A4C36		1
108	RCR07G122KS	2	RESISTOR,FXD, CMPSN, 1.2K, 10%, 1/4W (V81349) 745-0752-000 A4R46		1
109	2N2222A	2	TRANSISTOR, (V81350) 352-7500-280 A4Q4		1
110	2C067472X0101A3	2	CAPACITOR,FXD, CER DIEI, 0.0047UF, 20%, 100V (V56289) 913-4240-110 A4C37		1
111	RCR07G153KS	2	RESISTOR,FXD, CMPSN, 15K, 10%, 1/4W (V81349) 745-0791-000 A4R27		1
112	RCR07G103KS	2	RESISTOR,FXD, CMPSN, 10K, 10%, 1/4W (V81349) 745-0785-000 A4R28		1
113	2N2905	2	TRANSISTOR, (V81350) 352-7500-100 A4Q10 (EFF TO CI 71053)	BK	1
113	2N2222A	2	TRANSISTOR, (V81350) 352-7500-280 A4Q10 (EFF CI 71053)	BK	1
113	2N2222A	2	TRANSISTOR, (V81350) 352-7500-280 A4Q10	BL,BM	1
114	K059K102M	2	CAPACITOR,FXD, CER DIEI, 1000PF, 10%, 100V (V05397) 913-4489-360 A4C50		1
115	RCR07G103KS	2	RESISTOR,FXD, CMPSN, 10K, 10%, 1/4W (V81349) 745-0785-000 A4R59		1
116	RCR07G105KS	2	RESISTOR,FXD, CMPSN, 1MEGO, 10%, 1/4W (V81349) 745-0857-000 A4R88 (EFF TO CI 72433)	BM	1
116	RCR07G105KS	2	RESISTOR,FXD, CMPSN, 1MEGO, 10%, 1/4W (V81349) 745-0857-000 A4R88 (EFF CI 72433)	BM	AR
116	RCR07G155KS	2	RESISTOR,FXD, CMPSN, 1.5MEGO, 10%, 1/4W (V81349) 745-0863-000 A4R88 (EFF CI 72433)	BM	AR
116	RCR07G185KS	2	RESISTOR,FXD, CMPSN, 1.8MEGO, 10%, 1/4W (V81349) 745-0866-000 A4R88 (EFF CI 72433)	BM	AR
116	RCR07G225KS	2	RESISTOR,FXD, CMPSN, 2.2MEGO, 10%, 1/4W (V81349) 745-0869-000 A4R88 (EFF CI 72433)	BM	AR
116	RCR07G105KS	2	RESISTOR,FXD, CMPSN, 1MEGO, 10%, 1/4W (V81349) 745-0857-000 A4R88	BK,BL	1
117	150D105X0035A2	2	CAPACITOR,FXD, ELCTLT, 1UF, 20%, 35V (V56289) 184-7398-000 A4C71 (EFF TO CI 72165)	BK	1
117	M39003-01-2039	2	CAPACITOR,FXD, ELCTLT, 1.2UF, 10%, 20V (V81349) 184-9083-390 A4C71 (EFF CI 72165)	BK	1
117	150D156X9020B2	2	CAPACITOR,FXD, ELCTLT, 15UF, 10%, 20V (V56289) 184-7698-000 A4C71	BL	1
117	M39003-01-2039	2	CAPACITOR,FXD, ELCTLT, 1.2UF, 10%, 20V (V81349) 184-9083-390 A4C71 (EFF TO CI 72433)	BM	1
117	M39003-01-2117	2	CAPACITOR,FXD, ELCTLT, 1UF, 20%, 50V (V81349) 184-9084-440 A4C71 (EFF CI 72433)	BM	AR
117	M39003-01-2039	2	CAPACITOR,FXD, ELCTLT, 1.2UF, 10%, 20V (V81349) 184-9083-390 A4C71 (EFF CI 72433)	BM	AR
118	1N751A	2	SEMICOND DEVICE, (V07688) 353-2710-000 A4VR9		1
119	1N914	2	SEMICOND DEVICE, (V07688) 353-2906-000 A4CR8		1
120	1N459	2	SEMICOND DEVICE, (V07688) 353-0206-000 A4CR10	BK,BM	1

GROUP ASSEMBLY PARTS LIST

FIG - ITEM	PART NO	INDENT	DESCRIPTION	USABLE ON CODE	UNITS PER ASSY
21	120		MS90539-15		
	121	2	COIL, RF, 1000UH (V96906) 240-2540-000 A4L13	BL	1
	122	2	TRANSISTOR, (V07688) 352-0551-010 A4Q15		1
		2	RESISTOR, FXD, CMPSN, 22K, 10%, 1/4W (V81349)		1
			745-0797-000 A4R92		
	123	2	RESISTOR, FXD, CMPSN, 15K, 10%, 1/4W (V81349)		1
			745-0791-000 A4R91		
	124	2	RESISTOR, FXD, CMPSN, 22K, 10%, 1/4W (V81349)		1
			745-0797-000 A4R93		
	125	2	CAPACITOR, FXD, CER DIEL, 0.01UF, 20%, 100V (V56289) 913-4240-100 A4C78		1
	126	2	RESISTOR, FXD, CMPSN, 22K, 10%, 1/4W (V81349)		1
			745-0797-000 A4R100		
	127	2	RESISTOR, FXD, CMPSN, 1.5K, 10%, 1/4W (V81349)		1
			745-0755-000 A4R101		
	128	2	INTEGRATED CKT, (V07263) 351-7141-020 A4U1		1
	129	2	RESISTOR, THRM, 20K, 10%, 3.6W (V90634) 714-1138-070 A4RT99		1
	130	2	CAPACITOR, FXD, MICA DIEL, 330PF, 5%, 50V (V72136) 912-4141-490 A4C79		1
	131	2	RESISTOR, FXD, CMPSN, 47 OHMS, 10%, 1/2W (V81349)		1
			745-1296-000 A4R106		
	132	2	TRANSISTOR, (V81350) 352-7500-100 A4Q18		1
	133	2	TRANSISTOR, (V81350) 352-7500-280 A4Q17		1
	134	2	CAPACITOR, FXD, CER DIEL, 1000PF, 10%, 100V (V05397) 913-4489-360 A4C87		1
	135	2	RESISTOR, FXD, CMPSN, 2.2K, 10%, 1/4W (V81349)		1
			745-0761-000 A4R105		
	136	2	RESISTOR, FXD, CMPSN, 270 OHMS, 10%, 1/4W (V81349) 745-0728-000 A4R104		1
	137	2	RESISTOR, FXD, CMPSN, 5.6K, 10%, 1/4W (V81349)		1
			745-0776-000 A4R108		
	138	2	RESISTOR, FXD, CMPSN, 2.7K, 10%, 1/4W (V81349)		1
			745-0764-000 A4R2		
	139	2	SEMICONV DEVICE, (V07688) 922-6119-010 A4CR2		1
	140	2	CAPACITOR, FXD, CER DIEL, 0.1UF, 20%, 50V (V72982) 913-3279-200 A4C85		1
			M		
	141	2	CAPACITOR, FXD, CER DIEL, 0.1UF, 20%, 50V (V72982) 913-3279-200 A4C86		1
			M		
	142	2	SEMICONV DEVICE, (V07688) 353-0206-000 A4CR11		1
	143	2	SEMICONV DEVICE, (V07688) 353-0206-000 A4CR12		1
	144	2	RESISTOR, FXD, CMPSN, 2.2K, 10%, 1/4W (V81349)	BK, BM	1
			745-0761-000 A4R102		
	144	2	RESISTOR, FXD, CMPSN, 22K, 10%, 1/4W (V81349)	BL	1
			745-0797-000 A4R102		
	145	2	CAPACITOR, FXD, CER DIEL, 0.047UF, 20%, 100V (V56289) 913-4240-080 A4C72 (EFF TO CI 73156)		1
	145	2	CAPACITOR, FXD, CER DIEL, 0.068UF, 10%, 50V (V81349) 913-5019-300 A4C72 (EFF CI 73156)		1
	146	2	RESISTOR, FXD, CMPSN, 47 OHMS, 10%, 1/4W (V81349)		1
			745-0701-000 A4R10		
	147	2	RESISTOR, FXD, CMPSN, 0.22MEGO, 10%, 1/4W (V81349) 745-0833-000 A4R94	BK, BM	1
	148	2	RESISTOR, FXD, CMPSN, 10K, 10%, 1/4W (V81349)		1
			745-0785-000 A4R12		
	149	2	RESISTOR, FXD, CMPSN, 15K, 10%, 1/4W (V81349)		1
			745-0791-000 A4R11		
	150	2	SEMICONV DEVICE, (V07688) 922-6119-010 A4CR4		1
	151	2	TRANSISTOR, (V81350) 352-7500-280 A4Q2		1
	152	2	CAPACITOR, FXD, CER DIEL, 0.1UF, 20%, 50V (V72982) 913-3279-200 A4C14		1
			M		
	153	2	RESISTOR, FXD, CMPSN, 47 OHMS, 10%, 1/4W (V81349)		1
			745-0701-000 A4R17		
	154	2	RESISTOR, FXD, FILM, 267 OHMS, 1%, 1/8W (V96214) 705-1469-670 A4R14		1

## GROUP ASSEMBLY PARTS LIST

FIG - ITEM	PART NO	INDENT	DESCRIPTION	USABLE ON CODE	UNITS PER ASSY
21 155	RCR07G153KS	2	RESISTOR,FXD, CMPSN, 15K, 10%, 1/4W (V81349) 745-0791-000 A4R58		1
156	55D2670F	2	RESISTOR,FXD, FILM, 267 OHMS, 1%, 1/8W (V96214) 705-1469-670 A4R21		1
157	RCR07G153KS	2	RESISTOR,FXD, CMPSN, 15K, 10%, 1/4W (V81349) 745-0791-000 A4R19		1
158	RCR07G103KS	2	RESISTOR,FXD, CMPSN, 10K, 10%, 1/4W (V81349) 745-0785-000 A4R20		1
159	8131-050-651-104 M	2	CAPACITOR,FXD, CER DIEI, 0.1UF, 20%, 50V (V72982) 913-3279-200 A4C21		1
160	RCR07G470KS	2	RESISTOR,FXD, CMPSN, 47 OHMS, 10%, 1/4W (V81349) 745-0701-000 A4R26		1
161	RCR07G101KS	2	RESISTOR,FXD, CMPSN, 100 OHMS, 10%, 1/4W (V81349) 745-0713-000 A4R47		1
162	RCR07G470KS	2	RESISTOR,FXD, CMPSN, 47 OHMS, 10%, 1/4W (V81349) 745-0701-000 A4R24		1
163	T055-6490-1F	2	RESISTOR,FXD, FILM, 649 OHMS, 1%, 1/8W (V11502) 705-1470-570 A4R33		1
164	RCR07G153KS	2	RESISTOR,FXD, CMPSN, 15K, 10%, 1/4W (V81349) 745-0791-000 A4R29		1
165	M39003-01-2111	2	CAPACITOR,FXD, ELCTLT, 0.47UF, 20%, 50V (V81349) 184-9084-380 A4C27		1
166	RCR07G153KS	2	RESISTOR,FXD, CMPSN, 15K, 10%, 1/4W (V81349) 745-0791-000 A4R35		1
167	RCR07G151KS	2	RESISTOR,FXD, CMPSN, 150 OHMS, 10%, 1/4W (V81349) 745-0719-000 A4R34		1
168	55D8060F	2	RESISTOR,FXD, FILM, 806 OHMS, 1%, 1/8W (V96214) 705-1469-890 A4R37		1
169	RCR07G103KS	2	RESISTOR,FXD, CMPSN, 10K, 10%, 1/4W (V81349) 745-0785-000 A4R36		1
170	8131-050-651-104 M	2	CAPACITOR,FXD, CER DIEI, 0.1UF, 20%, 50V (V72982) 913-3279-200 A4C33		1
171	2C067332X0101A3	2	CAPACITOR,FXD, CER DIEI, 0.0033UF, 20%, 100V (V56289) 913-4240-150 A4C43		1
172	2C067103X0101A3	2	CAPACITOR,FXD, CER DIEI, 0.01UF, 20%, 100V (V56289) 913-4240-100 A4C41		1
173	MS90540-08	2	COIL,RF, 220UH (V96906) 240-2548-000 A4L11		1
174	RCR07G331KS	2	RESISTOR,FXD, CMPSN, 330 OHMS, 10%, 1/4W (V81349) 745-0731-000 A4R50		1
175	RCR07G223KS	2	RESISTOR,FXD, CMPSN, 22K, 10%, 1/4W (V81349) 745-0797-000 A4R49		1
176	RCR07G331KS	2	RESISTOR,FXD, CMPSN, 330 OHMS, 10%, 1/4W (V81349) 745-0731-000 A4R72	BK,BL	1
177	2C067332X0101A3	2	CAPACITOR,FXD, CER DIEI, 0.0033UF, 20%, 100V (V56289) 913-4240-150 A4C62	BK,BL	1
178	8131-050-651-104 M	2	CAPACITOR,FXD, CER DIEI, 0.1UF, 20%, 50V (V72982) 913-3279-200 A4C64		1
179	RCR07G562KS	2	RESISTOR,FXD, CMPSN, 5.6K, 10%, 1/4W (V81349) 745-0776-000 A4R74	BK,BL	1
180	RCR07G183KS	2	RESISTOR,FXD, CMPSN, 18K, 10%, 1/4W (V81349) 745-0794-000 A4R76	BK,BL	1
181	RCR07G472KS	2	RESISTOR,FXD, CMPSN, 4.7K, 10%, 1/4W (V81349) 745-0773-000 A4R75	BK,BL	1
182	RCR07G680KS	2	RESISTOR,FXD, CMPSN, 68 OHMS, 10%, 1/4W (V81349) 745-0707-000 A4R73	BK,BL	1
183	M39003-01-2047	2	CAPACITOR,FXD, ELCTLT, 10UF, 20%, 20V (V81349) 184-9083-470 A4C57	BK,BL	1
184	8131-050-651-104 M	2	CAPACITOR,FXD, CER DIEI, 0.1UF, 20%, 50V (V72982) 913-3279-200 A4C56	BK,BL	1
185	RCR07G103KS	2	RESISTOR,FXD, CMPSN, 10K, 10%, 1/4W (V81349) 745-0785-000 A4R68	BK,BL	1
186	RCR07G183KS	2	RESISTOR,FXD, CMPSN, 18K, 10%, 1/4W (V81349) 745-0794-000 A4R67	BK,BL	1

GROUP ASSEMBLY PARTS LIST

FIG - ITEM	PART NO	INDENT	DESCRIPTION	USABLE ON CODE	UNITS PER ASSY
21 187	2N2222A	2	TRANSISTOR, (V81350) 352-7500-280 A4012	BK,BL	1
188	RCR07G121JS	2	RESISTOR,FXD, CMPSN, 120 OHMS, 5%, 1/4W (V81349) 745-0715-000 A4R71	BK,BL	1
189	2C067472X0101A3	2	CAPACITOR,FXD, CER DIEI, 0.0047UF, 20%, 100V (V56289) 913-4240-110 A4C54	BK,BL	1
190	2N2222A	2	TRANSISTOR, (V81350) 352-7500-280 A4011		1
191	RCR07G272KS	2	RESISTOR,FXD, CMPSN, 2.7K, 10%, 1/4W (V81349) 745-0764-000 A4R87	BK,BM	1
191	RCR07G392KS	2	RESISTOR,FXD, CMPSN, 3.9K, 10%, 1/4W (V81349) 745-0770-000 A4R87	BL	1
192	RCR07G122KS	2	RESISTOR,FXD, CMPSN, 1.2K, 10%, 1/4W (V81349) 745-0752-000 A4R66		1
193	55D45R3F	2	RESISTOR,FXD, FILM, 45.3 OHMS, 1%, 1/8W (V96214) 705-1469-300 A4R65		1
194	8131-050-651-104 M	2	CAPACITOR,FXD, CER DIEI, 0.1UF, 20%, 50V (V72982) 913-3279-200 A4C53		1
195	MS90539-15	2	COIL,RF, 1000UH (V96906) 240-2540-000 A4L10		1
196	8131-050-651-104 M	2	CAPACITOR,FXD, CER DIEI, 0.1UF, 20%, 50V (V72982) 913-3279-200 A4C52		1
197	RCR07G101KS	2	RESISTOR,FXD, CMPSN, 100 OHMS, 10%, 1/4W (V81349) 745-0713-000 A4R64		1
198	M39003-01-2044	2	CAPACITOR,FXD, ELCTLT, 2.2UF, 20%, 20V (V81349) 184-9083-440 A4C67		1
199	2C067103X0101A3	2	CAPACITOR,FXD, CER DIEI, 0.01UF, 20%, 100V (V56289) 913-4240-100 A4C65		1
200	780-3065-001	2	TRANSFORMER, A4T4		1
201	RCR07G100KS	2	RESISTOR,FXD, CMPSN, 10 OHMS, 10%, 1/4W (V81349) 745-0677-000 A4R112		1
202	RCR07G332KS	2	RESISTOR,FXD, CMPSN, 3.3K, 10%, 1/4W (V81349) 745-0767-000 A4R110 (EFF TO CI 72473)		1
202	RCR07G222KS	2	RESISTOR,FXD, CMPSN, 2.2K, 10%, 1/4W (V81349) 745-0761-000 A4R110 (EFF CI 72473)		1
203	RCR07G472KS	2	RESISTOR,FXD, CMPSN, 4.7K, 10%, 1/4W (V81349) 745-0773-000 A4R83		1
204	1N914	2	SEMICONV DEVICE, (V07688) 353-2906-000 A4CR7		1
205	8131-050-651-104 M	2	CAPACITOR,FXD, CER DIEI, 0.1UF, 20%, 50V (V72982) 913-3279-200 A4C83		1
206	K058K102M	2	CAPACITOR,FXD, CER DIEI, 1000PF, 10%, 100V (V05397) 913-4489-360 A4C68		1
207	RCR07G473KS	2	RESISTOR,FXD, CMPSN, 47K, 10%, 1/4W (V81349) 745-0809-000 A4R84		1
208	RT22C2P202	2	RESISTOR,VAR,WW, 2K, 5%, 3/4W (V81349) 381-1721-050 A4R109		1
209	8131-050-651-104 M	2	CAPACITOR,FXD, CER DIEI, 0.1UF, 20%, 50V (V72982) 913-3279-200 A4C66		1
210	RCR07G102JS	2	RESISTOR,FXD, CMPSN, 1K, 5%, 1/4W (V81349) 745-0748-000 A4R111		1
211	8131-050-651-104 M	2	CAPACITOR,FXD, CER DIEI, 0.1UF, 20%, 50V (V72982) 913-3279-200 A4C80	BK,BM	1
212	1N459	2	SEMICONV DEVICE, (V07688) 353-0206-000 A4CR14		1
213	2N2222A	2	TRANSISTOR, (V81350) 352-7500-280 A4014		1
214	RCR07G223KS	2	RESISTOR,FXD, CMPSN, 22K, 10%, 1/4W (V81349) 745-0797-000 A4R96		1
215	2C067473X0101A3	2	CAPACITOR,FXD, CER DIEI, 0.047UF, 20%, 100V (V56289) 913-4240-080 A4C82		1
216	1N753A	2	SEMICONV DEVICE, (V07688) 353-2714-000 A4VR13		1
217	8131-050-651-104 M	2	CAPACITOR,FXD, CER DIEI, 0.1UF, 20%, 50V (V72982) 913-3279-200 A4C81		1
218	RCR07G103KS	2	RESISTOR,FXD, CMPSN, 10K, 10%, 1/4W (V81349) 745-0785-000 A4R97		1
219	RCR07G563KS	2	RESISTOR,FXD, CMPSN, 56K, 10%, 1/4W (V81349) 745-0812-000 A4R98		1
220	2N2222A	2	TRANSISTOR, (V81350) 352-7500-280 A4013		1

## GROUP ASSEMBLY PARTS LIST

FIG - ITEM	PART NO	INDENT	DESCRIPTION	USABLE ON CODE	UNITS PER ASSY
21 221	RCR07G103KS	2	RESISTOR,FXD, CMPSN, 10K, 10%, 1/4W (V81349) 745-0785-000 A4R86		1
222	RCR07G471KS	2	RESISTOR,FXD, CMPSN, 470 OHMS, 10%, 1/4W (V81349) 745-0737-000 A4R85		1
223	RCR07G182KS	2	RESISTOR,FXD, CMPSN, 1.8K, 10%, 1/4W (V81349) 745-0758-000 A4R89		1
224	M39003-01-2015	2	CAPACITOR,FXD, ELCTLT, 4.7UF, 20%, 10V (V81349) 184-9083-150 A4C70		1
225	M39003-01-2044	2	CAPACITOR,FXD, ELCTLT, 2.2UF, 20%, 20V (V81349) 184-9083-440 A4C69		1
226	2C067103X0101A3	2	CAPACITOR,FXD, CER DIEI, 0.01UF, 20%, 100V (V56289) 913-4240-100 A4C73		1
227	RCR07G392KS	2	RESISTOR,FXD, CMPSN, 3.9K, 10%, 1/4W (V81349) 745-0770-000 A4R90		1
228	2N2222A	2	TRANSISTOR, (V81350) 352-7500-280 A4Q16		1
229	RCR07G104KS	2	RESISTOR,FXD, CMPSN, 0.10MEGO, 10%, 1/4W (V81349) 745-0821-000 A4R81		1
230	RCR07G103KS	2	RESISTOR,FXD, CMPSN, 10K, 10%, 1/4W (V81349) 745-0785-000 A4R82		1
231	T055-1-78K1F	2	RESISTOR,FXD, FILM, 1.78K, 1%, 1/8W (V11502) 705-1454-450 A4R60		1
232	RT22C2P101	2	RESISTOR,VAR,HW, 100 OHMS, 5%, 3/4W (V81349) 381-1721-010 A4R61		1
233	8131-050-651-104 M	2	CAPACITOR,FXD, CER DIEI, 0.1UF, 20%, 50V (V72982) 913-3279-200 A4C55	BK,BL	1
234	RCR07G270KS	2	RESISTOR,FXD, CMPSN, 27 OHMS, 10%, 1/4W (V81349) 745-0692-000 A4R62 (EFF TO CI 72486)		1
234	RCR07G470KS	2	RESISTOR,FXD, CMPSN, 47 OHMS, 10%, 1/4W (V81349) 745-0701-000 A4R62 (EFF CI 72486)		1
235	RCR07G152KS	2	RESISTOR,FXD, CMPSN, 1.5K, 10%, 1/4W (V81349) 745-0755-000 A4R63		1
236	RCR07G102JS	2	RESISTOR,FXD, CMPSN, 1K, 5%, 1/4W (V81349) 745-0748-000 A4R70	BK,BL	1
237	RCR07G680KS	2	RESISTOR,FXD, CMPSN, 68 OHMS, 10%, 1/4W (V81349) 745-0707-000 A4R69	BK,BL	1
238	8131-050-651-104 M	2	CAPACITOR,FXD, CER DIEI, 0.1UF, 20%, 50V (V72982) 913-3279-200 A4C51		1
239	M39003-01-2067	2	CAPACITOR,FXD, ELCTLT, 22UF, 20%, 35V (V81349) 184-9083-670 A4C34		1
240	RCR07G182KS	2	RESISTOR,FXD, CMPSN, 1.8K, 10%, 1/4W (V81349) 745-0758-000 A4R80		1
241	D71F821J0	2	CAPACITOR,FXD, MICA DIEI, 820PF, 5%, 100V (V00953) 912-2093-220 A4C60	BK,BL	1
242	A266	2	INDUCTOR,RF, (V81815) 278-0385-010 A4L8	BK,BL	1
243	8131-050-651-104 M	2	CAPACITOR,FXD, CER DIEI, 0.1UF, 20%, 50V (V72982) 913-3279-200 A4C58	BK,BL	1
244	DM5F101J050WV	2	CAPACITOR,FXD, MICA DIEI, 100PF, 5%, 50V (V72136) 912-4141-050 A4C59	BK,BL	1
245	USE7754393	2	INTEGRATED CKT, (V07263) 351-1098-010 A4U2	BK,BL	1
246	2C067332X0101A3	2	CAPACITOR,FXD, CER DIEI, 0.0033UF, 20%, 100V (V56289) 913-4240-150 A4C61	BK,BL	1
247	RCR07G392KS	2	RESISTOR,FXD, CMPSN, 3.9K, 10%, 1/4W (V81349) 745-0770-000 A4R77	BK,BL	1
248	141-1002-0002	2	CONNECTOR,RCPT, ELEC (V98278) 357-7353-010 A4P1		1
249	141-1002-0002	2	CONNECTOR,RCPT, ELEC (V98278) 357-7353-010 A4P3		1
250	141-1002-0002	2	CONNECTOR,RCPT, ELEC (V98278) 357-7353-010 A4P4		1
251	141-1002-0002	2	CONNECTOR,RCPT, ELEC (V98278) 357-7353-010 A4P5		1
252	793-9822-001	2	HOUSING, CONNECTOR		4
253	779-2450-001	2	HANDLE	BK	1
253	779-2450-003	2	HANDLE	BL	1
253	779-2450-004	2	HANDLE	BM	1
	M851923-314	2	PIN,SPRING, SST, 0.078 DIA X 1/4 (V96906) 311-0465-000 (AP)		1

GROUP ASSEMBLY PARTS LIST

FIG - ITEM	PART NO	INDENT	DESCRIPTION	USABLE ON CODE	UNITS PER ASSY
21	254	RG196AU	2 CABLE,RF, (V80058) 425-1004-000		AR
	255	372-2601-037	2 CONTACT,ELEC, 372-2601-037		23
	256	372-2234-010	2 CONTACT,ELEC, (V13499) 372-2234-010		15
	257	372-2234-020	2 CONTACT,ELEC, (V13499) 372-2234-020		14
	258	372-2623-020	2 HOUSING,CONN,EL, 372-2623-020		J
	259	372-2623-013	2 HOUSING,CONN,EL, 372-2623-013		1
22 -	778-2952-001		1 CIRCUIT CARD ASSY, ISB A3 (SEE FIG 1-22 FOR NHA)	D,E,G,L Q,AE,AN AQ,AU	RF
	1	M39003-01-2056	2 CAPACITOR,FXD, ELCTLT, 47UF, 20%, 20V (V81349) 184-9083-560 A3C80		1
	2	M39003-01-2047	2 CAPACITOR,FXD, ELCTLT, 10UF, 20%, 20V (V81349) 184-9083-470 A3C58		1
	3	2C067103X0101A3	2 CAPACITOR,FXD, CER DIEL, 0.01UF, 20%, 100V (V56289) 913-4240-100 A3C86		1
	4	RCR07G102KS	2 RESISTOR,FXD, CMPSN, 1K, 10%, 1/4W (V81349) 745-0749-000 A3R53		1
	5	A265	2 TRANSFORMER,RF, (V81815) 278-0384-010 A3T3		1
	6	RCR07G272KS	2 RESISTOR,FXD, CMPSN, 2.7K, 10%, 1/4W (V81349) 745-0764-000 A3R50		1
	7	RCR07G122KS	2 RESISTOR,FXD, CMPSN, 1.2K, 10%, 1/4W (V81349) 745-0752-000 A3R48		1
	8	T055-61-9-1F	2 RESISTOR,FXD, FILM, 61.9 OHMS, 1%, 1/8W (V11502) 705-1454-100 A3R47		1
	9	8131-050-651-104 M	2 CAPACITOR,FXD, CER DIEL, 0.1UF, 20%, 50V (V72982) 913-3279-200 A3C26		1
	10	2N2222A	2 TRANSISTOR, (V81350) 352-7500-280 A3Q14		1
	11	K05SK102M	2 CAPACITOR,FXD, CER DIEL, 1000PF, 10%, 100V (V05397) 913-4489-360 A3C29		1
	12	T055-6490-1F	2 RESISTOR,FXD, FILM, 649 OHMS, 1%, 1/8W (V11502) 705-1470-570 A3R40		1
	13	2N2222A	2 TRANSISTOR, (V81350) 352-7500-280 A3Q13		1
	14	RCR07G103KS	2 RESISTOR,FXD, CMPSN, 10K, 10%, 1/4W (V81349) 745-0785-000 A3R39		1
	15	2C067472X0101A3	2 CAPACITOR,FXD, CER DIEL, 0.0047UF, 20%, 100V (V56289) 913-4240-110 A3C27		1
	16	1N5767	2 SEMICOND DEVICE, (V07688) 922-6119-010 A3CR6		1
	17	MS90537-49	2 COIL,RF, 1000UH (V96906) 240-2715-490 A3L6		1
	18	2C067472X0101A3	2 CAPACITOR,FXD, CER DIEL, 0.0047UF, 20%, 100V (V56289) 913-4240-110 A3C22		1
	19	2N2222A	2 TRANSISTOR, (V81350) 352-7500-280 A3Q3		1
	20	8131-050-651-104 M	2 CAPACITOR,FXD, CER DIEL, 0.1UF, 20%, 50V (V72982) 913-3279-200 A3C19		1
	21	2C067103X0101A3	2 CAPACITOR,FXD, CER DIEL, 0.01UF, 20%, 100V (V56289) 913-4240-100 A3C18		1
	22	1N5767	2 SEMICOND DEVICE, (V07688) 922-6119-010 A3CR5		1
	23	MS90537-49	2 COIL,RF, 1000UH (V96906) 240-2715-490 A3L4		1
	24	2C067472X0101A3	2 CAPACITOR,FXD, CER DIEL, 0.0047UF, 20%, 100V (V56289) 913-4240-110 A3C15		1
	25	T055-86R6-1F	2 RESISTOR,FXD, FILM, 86.6 OHMS, 1%, 1/8W (V11502) 705-1470-350 A3R15		1
	26	2N2222A	2 TRANSISTOR, (V81350) 352-7500-280 A3Q2		1
	27	2C067472X0101A3	2 CAPACITOR,FXD, CER DIEL, 0.0047UF, 20%, 100V (V56289) 913-4240-110 A3C13		1



GROUP ASSEMBLY PARTS LIST

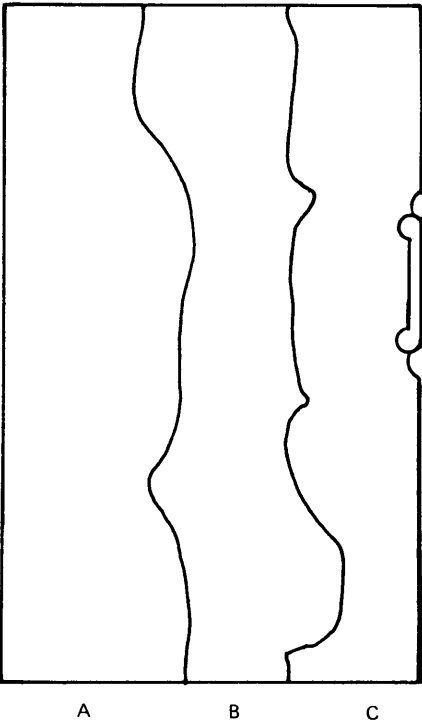

TP3-1037-047

*ISB Circuit Card Assembly (A3) 778-2952-001  
Figure 22 (Sheet 1 of 4)*

GROUP ASSEMBLY PARTS LIST

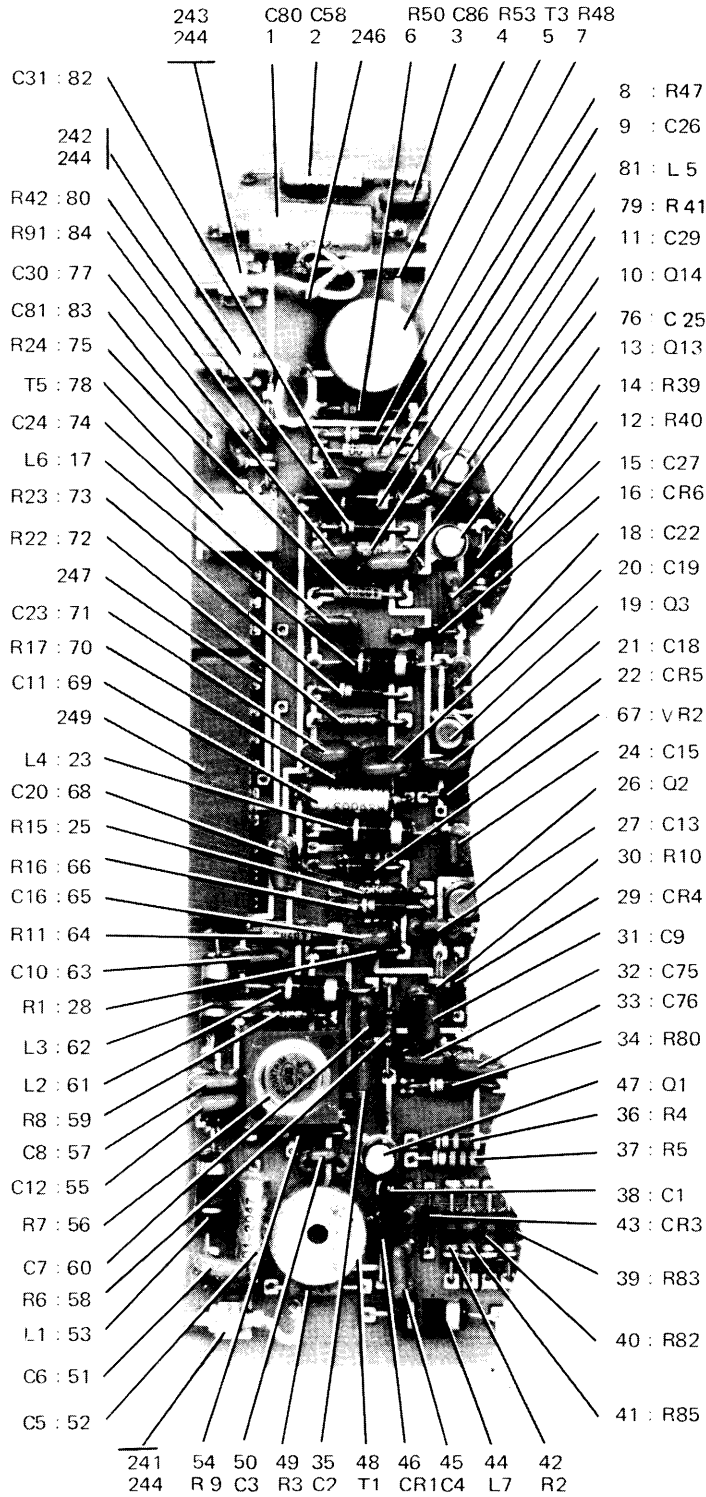

TP3-1037-047

ISB Circuit Card Assembly (A3) 778-2952-001  
Figure 22 (Sheet 2 of 4)

GROUP ASSEMBLY PARTS LIST

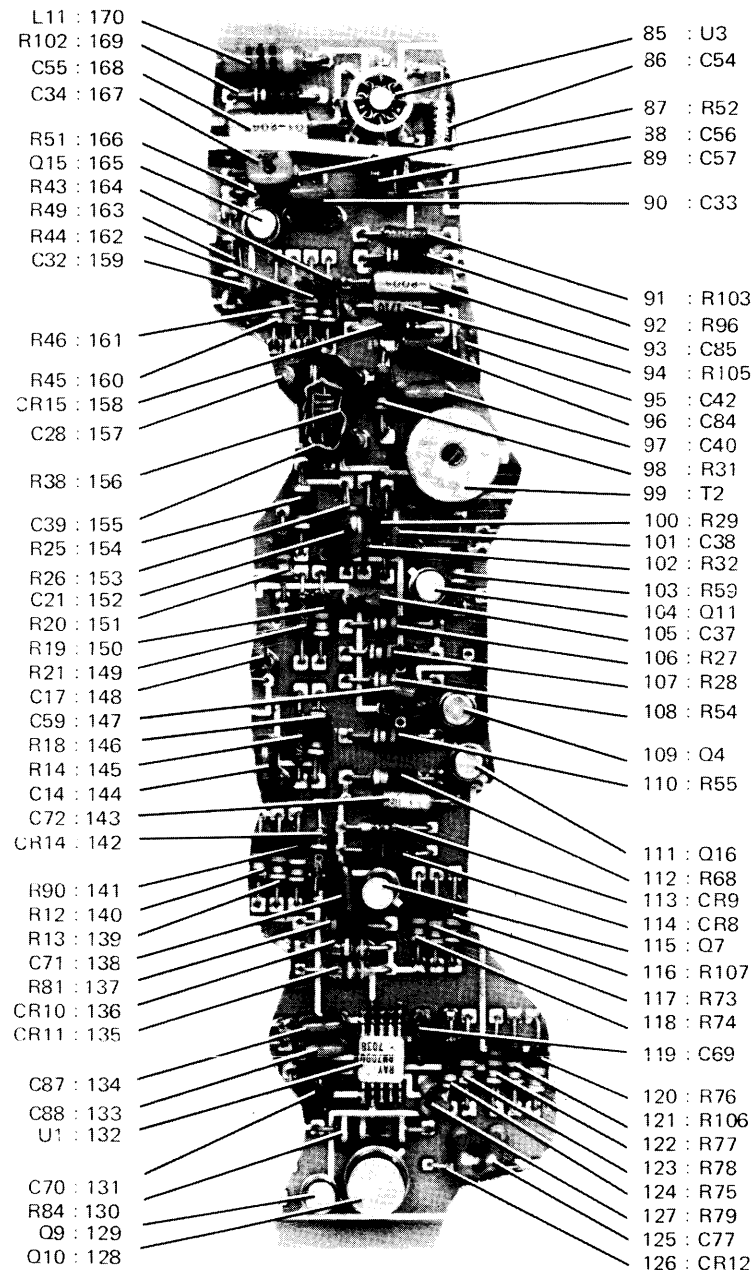

TP3-1037-047

ISB Circuit Card Assembly (A3) 778-2952-001  
Figure 22 (Sheet 3 of 4)

GROUP ASSEMBLY PARTS LIST

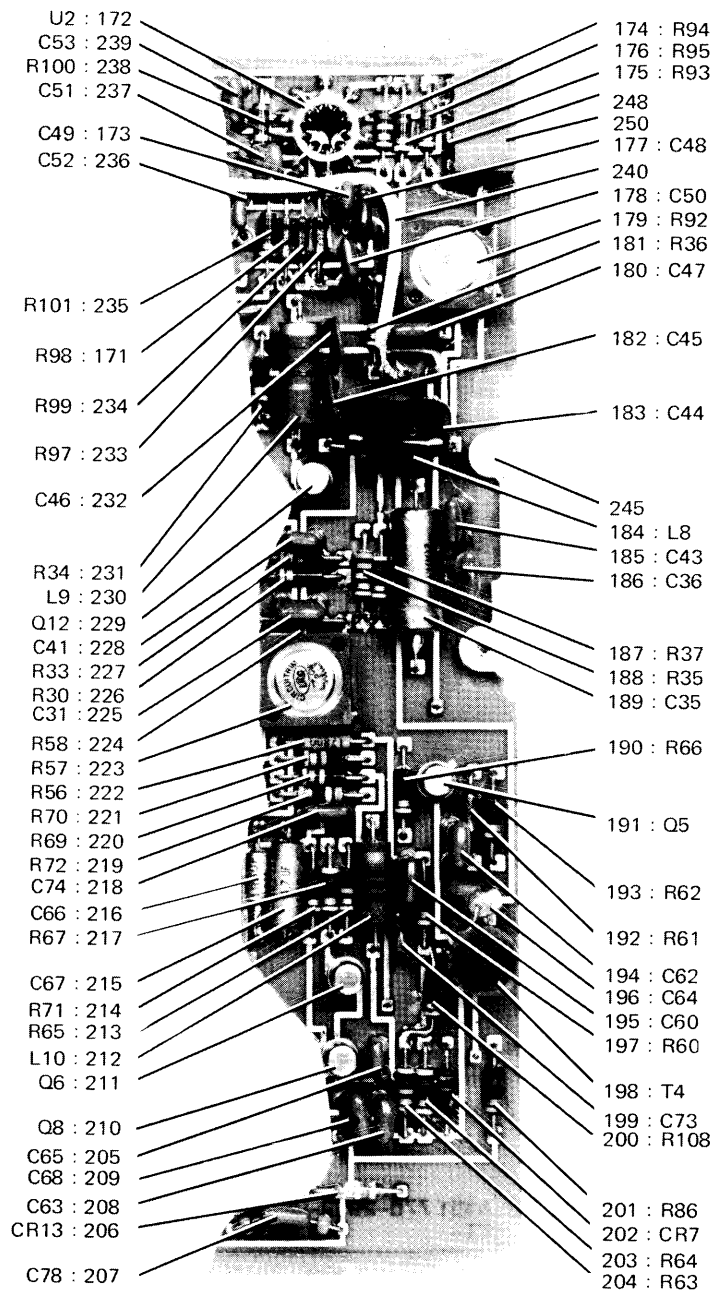

TP3-1037-047

ISB Circuit Card Assembly (A3) 778-2952-001  
 Figure 22 (Sheet 4 of 4)

GROUP ASSEMBLY PARTS LIST

FIG - ITEM	PART NO	INDENT	DESCRIPTION	USABLE ON CODE	UNITS PER ASSY
22	28	RCR07G102KS	2 RESISTOR,FXD, CMPSN, 1K, 10%, 1/4W (V81349) 745-0749-000 A3R1		1
	29	1N5767	2 SEMICOND DEVICE, (V07688) 922-6119-010 A3CR4		1
	30	RCR07G470KS	2 RESISTOR,FXD, CMPSN, 47 OHMS, 10%, 1/4W (V81349) 745-0701-000 A3R10		1
	31	8131-050-651-104 M	2 CAPACITOR,FXD, CER DIEI, 0.1UF, 20%, 50V (V72982) 913-3279-200 A3C9		1
	32	2C067103X0101A3	2 CAPACITOR,FXD, CER DIEI, 0.01UF, 20%, 100V (V56289) 913-4240-100 A3C75		1
	33	2C067103X0101A3	2 CAPACITOR,FXD, CER DIEI, 0.01UF, 20%, 100V (V56289) 913-4240-100 A3C76		1
	34	RCR07G222KS	2 RESISTOR,FXD, CMPSN, 2.2K, 10%, 1/4W (V81349) 745-0761-000 A3R80		1
	35	8131-050-651-104 M	2 CAPACITOR,FXD, CER DIEI, 0.1UF, 20%, 50V (V72982) 913-3279-200 A3C2		1
	36	RCR07G473KS	2 RESISTOR,FXD, CMPSN, 47K, 10%, 1/4W (V81349) 745-0809-000 A3R4		1
	37	RCR07G333KS	2 RESISTOR,FXD, CMPSN, 33K, 10%, 1/4W (V81349) 745-0803-000 A3R5		1
	38	D71F152J0	2 CAPACITOR,FXD, MICA DIEI, 1500PF, 5%, 100V (V00453) 912-2093-280 A3C1		1
	39	RCR07G222KS	2 RESISTOR,FXD, CMPSN, 2.2K, 10%, 1/4W (V81349) 745-0761-000 A3R83		1
	40	RCR07G271KS	2 RESISTOR,FXD, CMPSN, 270 OHMS, 10%, 1/4W (V81349) 745-0728-000 A3R82		1
	41	RCR07G562KS	2 RESISTOR,FXD, CMPSN, 5.6K, 10%, 1/4W (V81349) 745-0776-000 A3R85		1
	42	RCR07G272KS	2 RESISTOR,FXD, CMPSN, 2.7K, 10%, 1/4W (V81349) 745-0764-000 A3R2		1
	43	1N5767	2 SEMICOND DEVICE, (V07688) 922-6119-010 A3CR3		1
	44	MS90537-49	2 COIL,RF, 1000UH (V96906) 240-2715-490 A3L7		1
	45	2C067103X0101A3	2 CAPACITOR,FXD, CER DIEI, 0.01UF, 20%, 100V (V56289) 913-4240-100 A3C4		1
	46	1N4003	2 SEMICOND DEVICE, (V04713) 353-6442-030 A3CR1		1
	47	2N2222A	2 TRANSISTOR, (V81350) 352-7500-280 A301		1
	48	A264	2 TRANSFORMER,VAR, (V81815) 278-0383-010 A3T1		1
	49	T055-11800-1F	2 RESISTOR,FXD, FILM, 11.8K, 1%, 1/8W (V11502) 705-1468-450 A3R3		1
	50	2C067472X0101A3	2 CAPACITOR,FXD, CER DIEI, 0.0047UF, 20%, 100V (V56289) 913-4240-110 A3C3		1
	51	8131-050-651-104 M	2 CAPACITOR,FXD, CER DIEI, 0.1UF, 20%, 50V (V72982) 913-3279-200 A3C6		1
	52	M39003-01-2047	2 CAPACITOR,FXD, ELCTLT, 10UF, 20%, 20V (V81349) 184-9083-470 A3C5		1
	53	MS90537-49	2 COIL,RF, 1000UH (V96906) 240-2715-490 A3L1		1
	54	RCR07G122KS	2 RESISTOR,FXD, CMPSN, 1.2K, 10%, 1/4W (V81349) 745-0752-000 A3R9		1
	55	8131-050-651-104 M	2 CAPACITOR,FXD, CER DIEI, 0.1UF, 20%, 50V (V72982) 913-3279-200 A3C12		1
	56	RT22C2P101	2 RESISTOR,VAR,WW, 100 OHMS, 5%, 3/4W (V81349) 381-1721-010 A3R7		1
	57	8131-050-651-104 M	2 CAPACITOR,FXD, CER DIEI, 0.1UF, 20%, 50V (V72982) 913-3279-200 A3C8		1
	58	55D2670F	2 RESISTOR,FXD, FILM, 267 OHMS, 1%, 1/8W (V96214) 705-1469-670 A3R6		1
	59	55D32R4F	2 RESISTOR,FXD, FILM, 32.4 OHMS, 1%, 1/8W (V96214) 705-1469-230 A3R8		1
	60	2C067472X0101A3	2 CAPACITOR,FXD, CER DIEI, 0.0047UF, 20%, 100V (V56289) 913-4240-110 A3C7		1
	61	MS90537-49	2 COIL,RF, 1000UH (V96906) 240-2715-490 A3L2		1
	62	MS90537-49	2 COIL,RF, 1000UH (V96906) 240-2715-490 A3L3		1
	63	2C067103X0101A3	2 CAPACITOR,FXD, CER DIEI, 0.01UF, 20%, 100V (V56289) 913-4240-100 A3C10		1

GROUP ASSEMBLY PARTS LIST

FIG - ITEM	PART NO	INDENT	DESCRIPTION	USABLE ON CODE	UNITS PER ASSY
22 64	T055-4021-1F	2	RESISTOR,FXD, FILM, 4.02K, 1%, 1/8W (V11502) 705-1470-770 A3R11		1
65	8131-050-651-104 M	2	CAPACITOR,FXD, CER DIEI, 0.1UF, 20%, 50V (V72982) 913-3279-200 A3C16		1
66	RCR07G122KS	2	RESISTOR,FXD, CMPSN, 1.2K, 10%, 1/4W (V81349) 745-0752-000 A3R16		1
67	1N746A	2	SEMICOND DEVICE, (V07688) 353-2938-000 A3VR2		1
68	8131-050-651-104 M	2	CAPACITOR,FXD, CER DIEI, 0.1UF, 20%, 50V (V72982) 913-3279-200 A3C20		1
69	M39003-01-2047	2	CAPACITOR,FXD, ELCTLT, 10UF, 20%, 20V (V81349) 184-9083-470 A3C11		1
70	T055-4021-1F	2	RESISTOR,FXD, FILM, 4.02K, 1%, 1/8W (V11502) 705-1470-770 A3R17		1
71	8131-050-651-104 M	2	CAPACITOR,FXD, CER DIEI, 0.1UF, 20%, 50V (V72982) 913-3279-200 A3C23		1
72	T055-86R6-1F	2	RESISTOR,FXD, FILM, 86.6 OHMS, 1%, 1/8W (V11502) 705-1470-350 A3R22 (EFF TO CI 72376)		1
72	997F18	2	RESISTOR,THRM, 100 OHMS, 10%, 0.5W (V10646) 714-1723-000 A3R22 (EFF CI 72376)		1
73	RCR07G122KS	2	RESISTOR,FXD, CMPSN, 1.2K, 10%, 1/4W (V81349) 745-0752-000 A3R23		1
74	2C067103X0101A3	2	CAPACITOR,FXD, CER DIEI, 0.01UF, 20%, 100V (V56289) 913-4240-100 A3C24		1
75	T055-4021-1F	2	RESISTOR,FXD, FILM, 4.02K, 1%, 1/8W (V11502) 705-1470-770 A3R24		1
76	8131-050-651-104 M	2	CAPACITOR,FXD, CER DIEI, 0.1UF, 20%, 50V (V72982) 913-3279-200 A3C25		1
77	8131-050-651-104 M	2	CAPACITOR,FXD, CER DIEI, 0.1UF, 20%, 50V (V72982) 913-3279-200 A3C30		1
78	SP67	2	TRANSFORMER,AF, (V81095) 677-1684-000 A3T5		1
79	T055-61-9-1F	2	RESISTOR,FXD, FILM, 61.9 OHMS, 1%, 1/8W (V11502) 705-1454-100 A3R41		1
80	RCR07G122KS	2	RESISTOR,FXD, CMPSN, 1.2K, 10%, 1/4W (V81349) 745-0752-000 A3R42		1
81	MS90537-49	2	COIL,RF, 1000UH (V96906) 240-2715-490 A3L5		1
82	8131-050-651-104 M	2	CAPACITOR,FXD, CER DIEI, 0.1UF, 20%, 50V (V72982) 913-3279-200 A3C31		1
83	8131-050-651-104 M	2	CAPACITOR,FXD, CER DIEI, 0.1UF, 20%, 50V (V72982) 913-3279-200 A3C81		1
84	RCR07G102KS	2	RESISTOR,FXD, CMPSN, 1K, 10%, 1/4W (V81349) 745-0749-000 A3R91		1
85	U5B7716393	2	INTEGRATED CKT, (V07263) 351-1008-010 A3U3		1
86	M39003-01-2015	2	CAPACITOR,FXD, ELCTLT, 4.7UF, 20%, 10V (V81349) 184-9083-150 A3C54		1
87	RCR07G471KS	2	RESISTOR,FXD, CMPSN, 470 OHMS, 10%, 1/4W (V81349) 745-0737-000 A3R52		1
88	DM5E430J050WV	2	CAPACITOR,FXD, MICA DIEI, 43PF, 5%, 50V (V72136) 912-4141-260 A3C56		1
89	DM5E680J050WV	2	CAPACITOR,FXD, MICA DIEI, 68PF, 5%, 50V (V72136) 912-4141-330 A3C57		1
90	8131-050-651-104 M	2	CAPACITOR,FXD, CER DIEI, 0.1UF, 20%, 50V (V72982) 913-3279-200 A3C33		1
91	T055-75-1F	2	RESISTOR,FXD, FILM, 75 OHMS, 1%, 1/8W (V11502) 705-1454-120 A3R103		1
92	RCR07G151KS	2	RESISTOR,FXD, CMPSN, 150 OHMS, 10%, 1/4W (V81349) 745-0719-000 A3R96		1
93	M39003-01-2005	2	CAPACITOR,FXD, ELCTLT, 47UF, 20%, 6V (V81349) 184-9083-050 A3C85		1
94	55D2000F	2	RESISTOR,FXD, FILM, 200 OHMS, 1%, 1/8W (V96214) 705-1469-610 A3R105		1
95	2C067103X0101A3	2	CAPACITOR,FXD, CER DIEI, 0.01UF, 20%, 100V (V56289) 913-4240-100 A3C42		1

## GROUP ASSEMBLY PARTS LIST

FIG - ITEM	PART NO	INDENT	DESCRIPTION	USABLE ON CODE	UNITS PER ASSY
22	96	2C067103X0101A3	2 CAPACITOR,FXD, CER DIEI, 0.01UF, 20%, 100V (V56289) 913-4240-100 A3C84		1
	97	8131-050-651-104 M	2 CAPACITOR,FXD, CER DIEI, 0.1UF, 20%, 50V (V72982) 913-3279-200 A3C40		1
	98	RCR07G682KS	2 RESISTOR,FXD, CMPSN, 6.8K, 10%, 1/4W (V81349) 745-0779-000 A3R31		1
	99	A249	2 TRANSFORMER,RF, (V81815) 278-0386-010 A3T2		1
100	T055-78R7-1F		2 RESISTOR,FXD, FILM, 78.7 OHMS, 1%, 1/8W (V11502) 705-1470-340 A3R29		1
	101	8131-050-651-104 M	2 CAPACITOR,FXD, CER DIEI, 0.1UF, 20%, 50V (V72982) 913-3279-200 A3C38		1
	102	RCR07G101KS	2 RESISTOR,FXD, CMPSN, 100 OHMS, 10%, 1/4W (V81349) 745-0713-000 A3R32		1
	103	RCR07G152KS	2 RESISTOR,FXD, CMPSN, 1.5K, 10%, 1/4W (V81349) 745-0755-000 A3R59		1
	104	2N2222A	2 TRANSISTOR, (V81350) 352-7500-280 A3Q11		1
	105	2C067472X0101A3	2 CAPACITOR,FXD, CER DIEI, 0.0047UF, 20%, 100V (V56289) 913-4240-110 A3C37		1
	106	RCR07G153KS	2 RESISTOR,FXD, CMPSN, 15K, 10%, 1/4W (V81349) 745-0791-000 A3R27		1
	107	RCR07G103KS	2 RESISTOR,FXD, CMPSN, 10K, 10%, 1/4W (V81349) 745-0785-000 A3R28		1
	108	RCR07G153KS	2 RESISTOR,FXD, CMPSN, 15K, 10%, 1/4W (V81349) 745-0791-000 A3R54		1
	109	2N2222A	2 TRANSISTOR, (V81350) 352-7500-280 A3Q4		1
	110	RCR07G103KS	2 RESISTOR,FXD, CMPSN, 10K, 10%, 1/4W (V81349) 745-0785-000 A3R55		1
	111	2N2222A	2 TRANSISTOR, (V81350) 352-7500-280 A3Q16		1
	112	RCR07G105KS	2 RESISTOR,FXD, CMPSN, 1MEG0, 10%, 1/4W (V81349) 745-0857-000 A3R68		1
	113	1N751A	2 SEMICOND DEVICE, (V07688) 353-2710-000 A3CR9		1
	114	1N914	2 SEMICOND DEVICE, (V07688) 353-2906-000 A3CR8		1
	115	2N2907A	2 TRANSISTOR, (V07688) 352-0551-010 A3Q7		1
	116	RCR07G183KS	2 RESISTOR,FXD, CMPSN, 18K, 10%, 1/4W (V81349) 745-0794-000 A3R107		1
	117	RCR07G223KS	2 RESISTOR,FXD, CMPSN, 22K, 10%, 1/4W (V81349) 745-0797-000 A3R73		1
	118	RCR07G223KS	2 RESISTOR,FXD, CMPSN, 22K, 10%, 1/4W (V81349) 745-0797-000 A3R74		1
	119	2C067103X0101A3	2 CAPACITOR,FXD, CER DIEI, 0.01UF, 20%, 100V (V56289) 913-4240-100 A3C69		1
	120	RCR07G223KS	2 RESISTOR,FXD, CMPSN, 22K, 10%, 1/4W (V81349) 745-0797-000 A3R76		1
	121	RCR07G103KS	2 RESISTOR,FXD, CMPSN, 10K, 10%, 1/4W (V81349) 745-0785-000 A3R106		1
	122	RCR07G563KS	2 RESISTOR,FXD, CMPSN, 56K, 10%, 1/4W (V81349) 745-0812-000 A3R77		1
	123	RCR07G223KS	2 RESISTOR,FXD, CMPSN, 22K, 10%, 1/4W (V81349) 745-0797-000 A3R78		1
	124	RCR07G152KS	2 RESISTOR,FXD, CMPSN, 1.5K, 10%, 1/4W (V81349) 745-0755-000 A3R75		1
	125	8131-050-651-104 M	2 CAPACITOR,FXD, CER DIEI, 0.1UF, 20%, 50V (V72982) 913-3279-200 A3C77		1
	126	1N753A	2 SEMICOND DEVICE, (V07688) 353-2714-000 A3CR12		1
	127	42TF29	2 RESISTOR,THRM, 20K, 10%, 3.6W (V90634) 714-1138-070 A3R79		1
	128	2N2905	2 TRANSISTOR, (V81350) 352-7500-100 A3Q10		1
	129	2N2222A	2 TRANSISTOR, (V81350) 352-7500-280 A3Q9		1
	130	RCR20G470KS	2 RESISTOR,FXD, CMPSN, 47 OHMS, 10%, 1/2W (V81349) 745-1296-000 A3R84		1
	131	DM5F331J050NV	2 CAPACITOR,FXD, MICA DIEI, 330PF, 5%, 50V (V72136) 912-4141-490 A3C70		1
	132	U3F770931	2 INTEGRATED CKT, (V07263) 351-7141-020 A3U1		1

GROUP ASSEMBLY PARTS LIST

FIG - ITEM	PART NO	INDENT	DESCRIPTION	USABLE ON CODE	UNITS PER ASSY
22 133	8131-050-651-104	2	CAPACITOR,FXD, CER DIEI, 0.1UF, 20%, 50V (V72982) 913-3279-200 A3C88		1
134	8131-050-651-104	2	CAPACITOR,FXD, CER DIEI, 0.1UF, 20%, 50V (V72982) 913-3279-200 A3C87		1
135	1N459	2	SEMICOND DEVICE, (V07688) 353-0206-000 A3CR11		1
136	1N459	2	SEMICOND DEVICE, (V07688) 353-0206-000 A3CR10		1
137	RCR07G222KS	2	RESISTOR,FXD, CMPSN, 2.2K, 10%, 1/4W (V81349) 745-0761-000 A3R81		1
138	2C067473X0101A3	2	CAPACITOR,FXD, CER DIEI, 0.047UF, 20%, 100V (V56289) 913-4240-080 A3C71		1
139	RCR07G103KS	2	RESISTOR,FXD, CMPSN, 10K, 10%, 1/4W (V81349) 745-0785-000 A3R13		1
140	RCR07G153KS	2	RESISTOR,FXD, CMPSN, 15K, 10%, 1/4W (V81349) 745-0791-000 A3R12		1
141	RCR07G224KS	2	RESISTOR,FXD, CMPSN, 0.22MEGO, 10%, 1/4W (V81349) 745-0833-000 A3R90		1
142	1N459	2	SEMICOND DEVICE, (V07688) 353-0206-000 A3CR14		1
143	150D105X0035A2	2	CAPACITOR,FXD, ELCTLT, 1UF, 20%, 35V (V56289) 184-7398-000 A3C72		1
144	8131-050-651-104	2	CAPACITOR,FXD, CER DIEI, 0.1UF, 20%, 50V (V72982) 913-3279-200 A3C14		1
145	55D2670F	2	RESISTOR,FXD, FILM, 267 OHMS, 1%, 1/8W (V96214) 705-1469-670 A3R14		1
146	RCR07G470KS	2	RESISTOR,FXD, CMPSN, 47 OHMS, 10%, 1/4W (V81349) 745-0701-000 A3R18		1
147	K05SK102M	2	CAPACITOR,FXD, CER DIEI, 1000PF, 10%, 100V (V05397) 913-4489-360 A3C59		1
148	2C067472X0101A3	2	CAPACITOR,FXD, CER DIEI, 0.0047UF, 20%, 100V (V56289) 913-4240-110 A3C17		1
149	55D2670F	2	RESISTOR,FXD, FILM, 267 OHMS, 1%, 1/8W (V96214) 705-1469-670 A3R21		1
150	RCR07G153KS	2	RESISTOR,FXD, CMPSN, 15K, 10%, 1/4W (V81349) 745-0791-000 A3R19		1
151	RCR07G103KS	2	RESISTOR,FXD, CMPSN, 10K, 10%, 1/4W (V81349) 745-0785-000 A3R20		1
152	8131-050-651-104	2	CAPACITOR,FXD, CER DIEI, 0.1UF, 20%, 50V (V72982) 913-3279-200 A3C21		1
153	RCR07G470KS	2	RESISTOR,FXD, CMPSN, 47 OHMS, 10%, 1/4W (V81349) 745-0701-000 A3R26		1
154	RCR07G470KS	2	RESISTOR,FXD, CMPSN, 47 OHMS, 10%, 1/4W (V81349) 745-0701-000 A3R25		1
155	CM06FD821J03	2	CAPACITOR,FXD, MICA DIEI, 820PF, 5%, 500V (V81349) 912-2995-000 A3C39		1
156	RCR07G153KS	2	RESISTOR,FXD, CMPSN, 15K, 10%, 1/4W (V81349) 745-0791-000 A3R38		1
157	M39003-01-2111	2	CAPACITOR,FXD, ELCTLT, 0.47UF, 20%, 50V (V81349) 184-9084-380 A3C28		1
158	1N4733	2	SEMICOND DEVICE, (V07688) 353-6481-120 A3CR15		1
159	K05SK102M	2	CAPACITOR,FXD, CER DIEI, 1000PF, 10%, 100V (V05397) 913-4489-360 A3C32		1
160	RCR07G103KS	2	RESISTOR,FXD, CMPSN, 10K, 10%, 1/4W (V81349) 745-0785-000 A3R45		1
161	55D8060F	2	RESISTOR,FXD, FILM, 806 OHMS, 1%, 1/8W (V96214) 705-1469-890 A3R46		1
162	RCR07G153KS	2	RESISTOR,FXD, CMPSN, 15K, 10%, 1/4W (V81349) 745-0791-000 A3R44		1
163	RCR07G472KS	2	RESISTOR,FXD, CMPSN, 4.7K, 10%, 1/4W (V81349) 745-0773-000 A3R49		1
164	RCR07G151KS	2	RESISTOR,FXD, CMPSN, 150 OHMS, 10%, 1/4W (V81349) 745-0719-000 A3R43		1
165	2N2222A	2	TRANSISTOR, (V81350) 352-7500-280 A3Q15		1
166	RCR07G470KS	2	RESISTOR,FXD, CMPSN, 47 OHMS, 10%, 1/4W (V81349) 745-0701-000 A3R51		1



## GROUP ASSEMBLY PARTS LIST

FIG - ITEM	PART NO	INDENT	DESCRIPTION	USABLE ON CODE	UNITS PER ASSY
22 167	8131-050-651-104	2	CAPACITOR,FXD, CER DIEI, 0.1UF, 20%, 50V (V72982) 913-3279-200 A3C34		1
	M				
168	M39003-01-2047	2	CAPACITOR,FXD, ELCTLT, 10UF, 20%, 20V (V81349)		1
			184-9083-470 A3C55		
169	RCR07G182KS	2	RESISTOR,FXD, CMPSN, 1.8K, 10%, 1/4W (V81349)		1
			745-0758-000 A3R102		
170	MS90539-15	2	COIL,RF, 1000UH (V96906) 240-2540-000 A3L11		1
171	T055-2000-1F	2	RESISTOR,FXD, FILM, 2K, 1%, 1/8W (V11502)		1
			705-1468-080 A3R98		
172	MC1435G	2	INTEGRATED CKT, (V04713) 351-1034-020 A3U2		1
173	K05SK102M	2	CAPACITOR,FXD, CER DIEI, 1000PF, 10%, 100V (V05197) 913-4489-360 A3C49		1
174	RCR07G474KS	2	RESISTOR,FXD, CMPSN, 0.47MEGO, 10%, 1/4W (V81349) 745-0845-000 A3R94		1
175	RCR07G472KS	2	RESISTOR,FXD, CMPSN, 4.7K, 10%, 1/4W (V81349)		1
			745-0773-000 A3R93		
176	RCR07G682KS	2	RESISTOR,FXD, CMPSN, 6.8K, 10%, 1/4W (V81349)		1
			745-0779-000 A3R95		
177	2C067103X0101A3	2	CAPACITOR,FXD, CER DIEI, 0.01UF, 20%, 100V (V56289) 913-4240-100 A3C48		1
178	2C067223X0101A3	2	CAPACITOR,FXD, CER DIEI, 0.022UF, 20%, 100V (V56289) 913-4240-090 A3C50		1
179	RT22C2P203	2	RESISTOR,VAR,HW, 20K, 5%, 3/4W (V81349)		1
			381-1721-150 A3R92		
180	8131-050-651-104	2	CAPACITOR,FXD, CER DIEI, 0.1UF, 20%, 50V (V72982) 913-3279-200 A3C47		1
	M				
181	RCR07G103KS	2	RESISTOR,FXD, CMPSN, 10K, 10%, 1/4W (V81349)		1
			745-0785-000 A3R36		
182	2C067332X0101A3	2	CAPACITOR,FXD, CER DIEI, 0.0033UF, 20%, 100V (V56289) 913-4240-150 A3C45		1
183	CM06FD621J03	2	CAPACITOR,FXD, MICA DIEI, 620PF, 5%, 500V (V81349) 912-2986-000 A3C44		1
184	MS90537-41	2	COIL,RF, 220UH (V96906) 240-2715-410 A3LA		1
185	8131-050-651-104	2	CAPACITOR,FXD, CER DIEI, 0.1UF, 20%, 50V (V72982) 913-3279-200 A3C43		1
	M				
186	8131-050-651-104	2	CAPACITOR,FXD, CER DIEI, 0.1UF, 20%, 50V (V72982) 913-3279-200 A3C36		1
	M				
187	RCR07G272KS	2	RESISTOR,FXD, CMPSN, 2.7K, 10%, 1/4W (V81349)		1
			745-0764-000 A3R37		
188	RCR07G334KS	2	RESISTOR,FXD, CMPSN, 0.33MEGO, 10%, 1/4W (V81349) 745-0839-000 A3R35		1
189	M39003-01-2067	2	CAPACITOR,FXD, ELCTLT, 22UF, 20%, 35V (V81349)		1
			184-9083-670 A3C35		
190	RCR07G122KS	2	RESISTOR,FXD, CMPSN, 1.2K, 10%, 1/4W (V81349)		1
			745-0752-000 A3R66 (EFF TO CI 72263)		
190	RCR07G272KS	2	RESISTOR,FXD, CMPSN, 2.7K, 10%, 1/4W (V81349)		1
			745-0764-000 A3R66 (EFF CI 72263)		
191	2N2222A	2	TRANSISTOR, (V81350) 352-7500-280 A3Q5		1
192	T055-78R7-1F	2	RESISTOR,FXD, FILM, 78.7 OHMS, 1%, 1/8W (V11502)		1
			705-1470-340 A3R61 (EFF TO CI 72263)		
192	55D45R3F	2	RESISTOR,FXD, FILM, 45.3 OHMS, 1%, 1/8W (V96214)		1
			705-1469-300 A3R61 (EFF CI 72263)		
193	RCR07G122KS	2	RESISTOR,FXD, CMPSN, 1.2K, 10%, 1/4W (V81349)		1
			745-0752-000 A3R62		
194	8131-050-651-104	2	CAPACITOR,FXD, CER DIEI, 0.1UF, 20%, 50V (V72982) 913-3279-200 A3C62		1
	M				
195	8131-050-651-104	2	CAPACITOR,FXD, CER DIEI, 0.1UF, 20%, 50V (V72982) 913-3279-200 A3C60		1
	M				
196	M39003-01-2044	2	CAPACITOR,FXD, ELCTLT, 2.2UF, 20%, 20V (V81349)		1
			184-9083-440 A3C64		
197	RCR07G101KS	2	RESISTOR,FXD, CMPSN, 100 OHMS, 10%, 1/4W (V81349) 745-0713-000 A3R60		1
198	780-3065-001	2	TRANSFORMER, A3T4		1

GROUP ASSEMBLY PARTS LIST

FIG - ITEM	PART NO	INDENT	DESCRIPTION	USABLE ON CODE	UNITS PER ASSY
22 199	2C067103X0101A3	2	CAPACITOR,FXD, CER DIEL, 0.01UF, 20%, 100V (V56289) 913-4240-100 A3C73		1
200	RCR07G100KS	2	RESISTOR,FXD, CMPSN, 10 OHMS, 10%, 1/4W (V81349) 745-0677-000 A3R108		1
201	RCR07G272KS	2	RESISTOR,FXD, CMPSN, 2.7K, 10%, 1/4W (V81349) 745-0764-000 A3R86		1
202	1N914	2	SEMICOND DEVICE, (V07688) 353-2906-000 A3CR7		1
203	RCR07G472KS	2	RESISTOR,FXD, CMPSN, 4.7K, 10%, 1/4W (V81349) 745-0773-000 A3R64		1
204	RCR07G473KS	2	RESISTOR,FXD, CMPSN, 47K, 10%, 1/4W (V81349) 745-0809-000 A3R63		1
205	K059K102M	2	CAPACITOR,FXD, CER DIEL, 1000PF, 10%, 100V (V05397) 913-4489-360 A3C65		1
206	1N459	2	SEMICOND DEVICE, (V07688) 353-0206-000 A3CR13		1
207	2C067473X0101A3	2	CAPACITOR,FXD, CER DIEL, 0.047UF, 20%, 100V (V56289) 913-4240-080 A3C78		1
208	8131-050-651-104 M	2	CAPACITOR,FXD, CER DIEL, 0.1UF, 20%, 50V (V72982) 913-3279-200 A3C63		1
209	8131-050-651-104 M	2	CAPACITOR,FXD, CER DIEL, 0.1UF, 20%, 50V (V72982) 913-3279-200 A3C68		1
210	2N2222A	2	TRANSISTOR, (V81350) 352-7500-280 A3Q8		1
211	2N2222A	2	TRANSISTOR, (V81350) 352-7500-280 A3Q6		1
212	MS90539-15	2	COIL,RF, 1000UH (V96906) 240-2540-000 A3L10		1
213	RCR07G103KS	2	RESISTOR,FXD, CMPSN, 10K, 10%, 1/4W (V81349) 745-0785-000 A3R65		1
214	RCR07G182KS	2	RESISTOR,FXD, CMPSN, 1.8K, 10%, 1/4W (V81349) 745-0758-000 A3R71		1
215	150D475X0035B2	2	CAPACITOR,FXD, ELCTLT, 4.7UF, 20%, 35V (V56289) 184-7396-000 A3C67		1
216	M39003-01-2044	2	CAPACITOR,FXD, ELCTLT, 2.2UF, 20%, 20V (V81349) 184-9083-440 A3C66		1
217	RCR07G471KS	2	RESISTOR,FXD, CMPSN, 470 OHMS, 10%, 1/4W (V81349) 745-0737-000 A3R67		1
218	2C067103X0101A3	2	CAPACITOR,FXD, CER DIEL, 0.01UF, 20%, 100V (V56289) 913-4240-100 A3C74		1
219	RCR07G392KS	2	RESISTOR,FXD, CMPSN, 3.9K, 10%, 1/4W (V81349) 745-0770-000 A3R72		1
220	RCR07G104KS	2	RESISTOR,FXD, CMPSN, 0.10MEGO, 10%, 1/4W (V81349) 745-0821-000 A3R69		1
221	RCR07G103KS	2	RESISTOR,FXD, CMPSN, 10K, 10%, 1/4W (V81349) 745-0785-000 A3R70		1
222	T055-1-78K1F	2	RESISTOR,FXD, FILM, 1.78K, 1%, 1/8W (V11502) 705-1454-450 A3R56		1
223	RT22C2P101	2	RESISTOR,VAR,HW, 100 OHMS, 5%, 3/4W (V81349) 381-1721-010 A3R57		1
224	RCR07G270KS	2	RESISTOR,FXD, CMPSN, 27 OHMS, 10%, 1/4W (V81349) 745-0692-000 A3R58		1
225	8131-050-651-104 M	2	CAPACITOR,FXD, CER DIEL, 0.1UF, 20%, 50V (V72982) 913-3279-200 A3C61		1
226	RCR07G122KS	2	RESISTOR,FXD, CMPSN, 1.2K, 10%, 1/4W (V81349) 745-0752-000 A3R30		1
227	RCR07G223KS	2	RESISTOR,FXD, CMPSN, 22K, 10%, 1/4W (V81349) 745-0797-000 A3R33		1
228	K059K102M	2	CAPACITOR,FXD, CER DIEL, 1000PF, 10%, 100V (V05397) 913-4489-360 A3C41		1
229	3N141	2	TRANSISTOR, (V07688) 352-0867-020 A3Q12		1
230	MS90540-08	2	COIL,RF, 2200UH (V96906) 240-2548-000 A3L9		1
231	RCR07G331KS	2	RESISTOR,FXD, CMPSN, 330 OHMS, 10%, 1/4W (V81349) 745-0731-000 A3R34		1
232	2C067332X0101A3	2	CAPACITOR,FXD, CER DIEL, 0.0033UF, 20%, 100V (V56289) 913-4240-150 A3C46		1
233	T055-2000-1F	2	RESISTOR,FXD, FILM, 2K, 1%, 1/8W (V11502) 705-1468-080 A3R97		1

GROUP ASSEMBLY PARTS LIST

FIG - ITEM	PART NO	INDENT	DESCRIPTION	USABLE ON CODE	UNITS PER ASSY
22 234	T055-2000-1F	2	RESISTOR,FXD, FILM, 2K, 1%, 1/8W (V11502) 705-1468-080 A3R99		1
235	RCR07G151KS	2	RESISTOR,FXD, CMPSN, 150 OHMS, 10%, 1/4W (V81349) 745-0719-000 A3R101		1
236	2C067472X0101A3	2	CAPACITOR,FXD, CER DIEL, 0.0047UF, 20%, 100V (V56289) 913-4240-110 A3C52		1
237	K05SK102M	2	CAPACITOR,FXD, CER DIEL, 1000PF, 10%, 100V (V05397) 913-4489-360 A3C51		1
238	RCR07G681KS	2	RESISTOR,FXD, CMPSN, 680 OHMS, 10%, 1/4W (V81349) 745-0743-000 A3R100		1
239	2C067103X0101A3	2	CAPACITOR,FXD, CER DIEL, 0.01UF, 20%, 100V (V56289) 913-4240-100 A3C53		1
240	RG196AU	2	CABLE,RF, (V80058) 425-1004-000		AR
241	141-1002-0002	2	CONNECTOR,RCPT, ELEC (V98278) 357-7353-010 A3P1		1
242	141-1002-0002	2	CONNECTOR,RCPT, ELEC (V98278) 357-7353-010 A3P3		1
243	141-1002-0002	2	CONNECTOR,RCPT, ELEC (V98278) 357-7353-010 A3P4		1
244	793-9822-001	2	HOUSING,CONN		3
	MS51923-314	2	PIN,SPRING, SST, 0.078 DIA X 1/4 (V96906) 311-0465-000 (AP)		1
245	778-3079-001	2	HANDLE		1
246	372-2601-037	2	CONTACT,ELEC, 372-2601-037		6
247	372-2234-010	2	CONTACT,ELEC, (V13499) 372-2234-010		14
248	372-2234-020	2	CONTACT,ELEC, (V13499) 372-2234-020		12
249	372-2623-022	2	HOUSING,CONN,EL, 372-2623-022		1
250	372-2623-013	2	HOUSING,CONN,EL, 372-2623-013		1

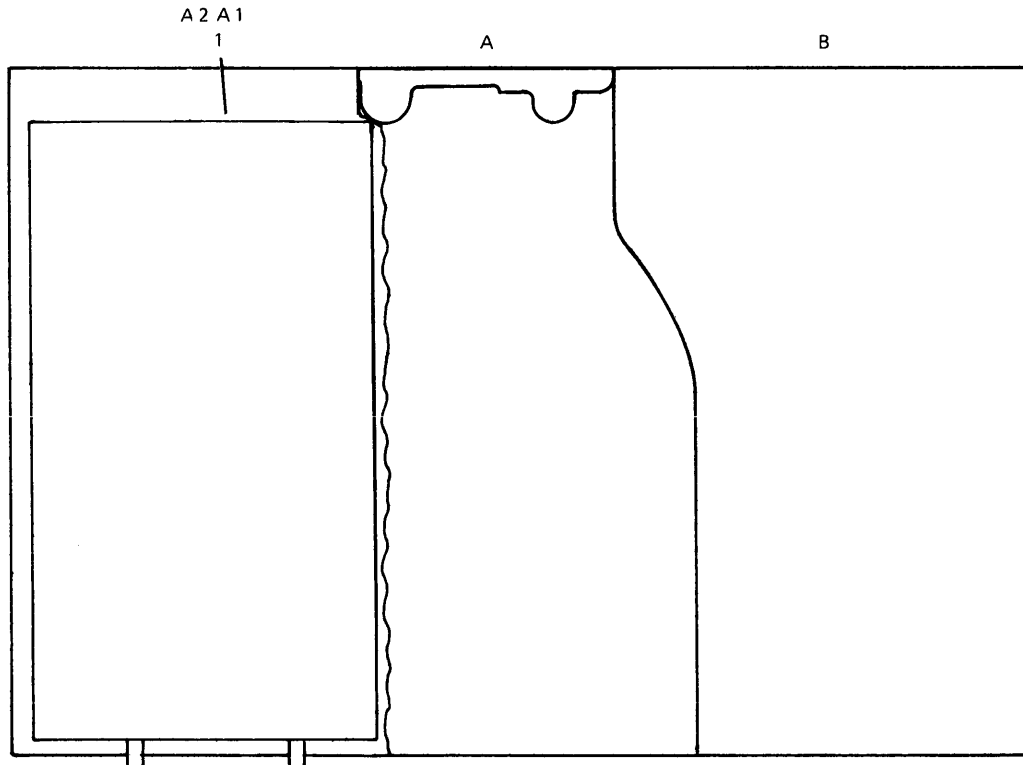

TP3-1038-037

Audio Amplifier Circuit Card Assembly (A2) 778-2948-008, -005  
Figure 23 (Sheet 1 of 3)

GROUP ASSEMBLY PARTS LIST

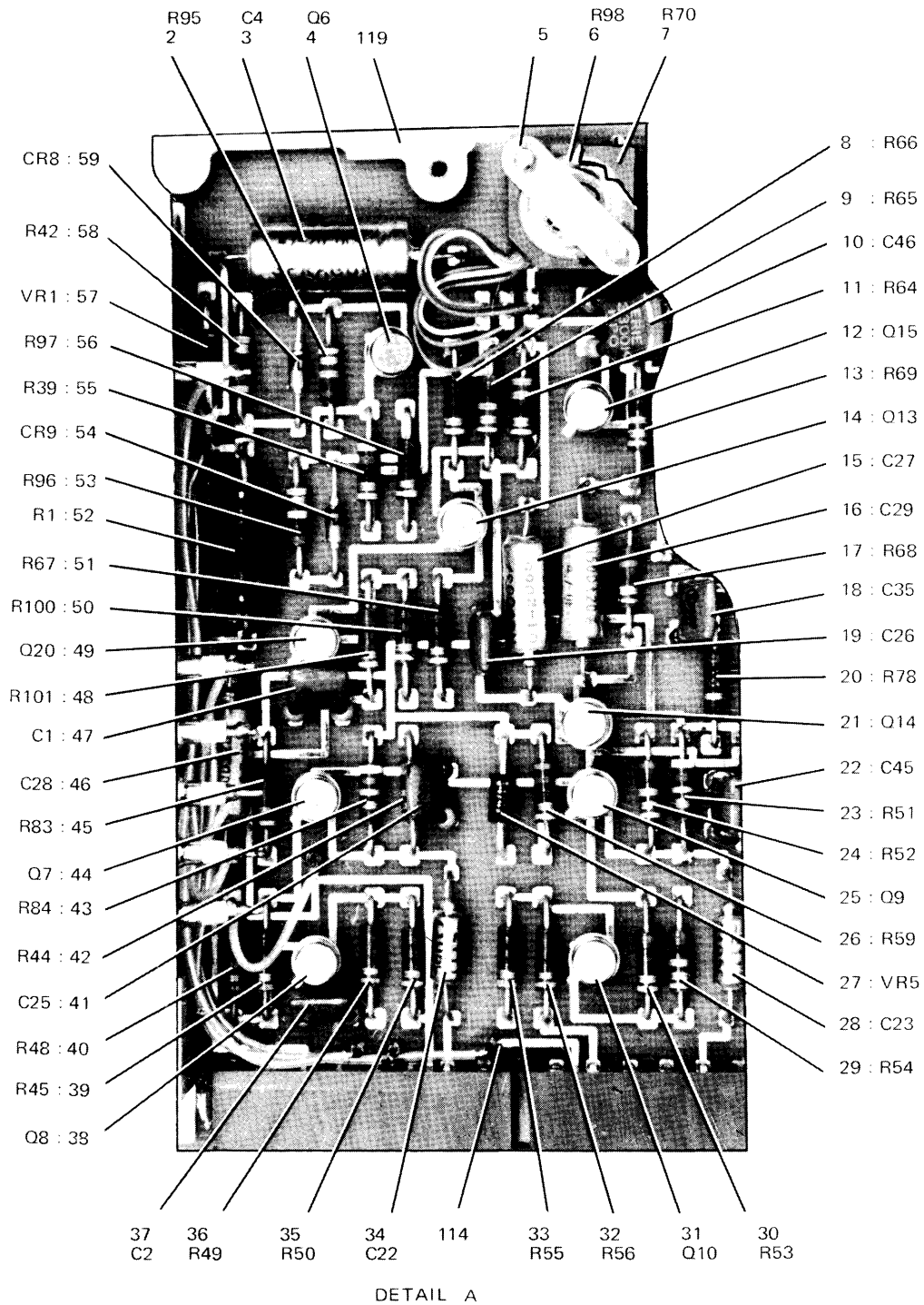

TP3-1038-037

Audio Amplifier Circuit Card Assembly (A2) 778-2948-003, -005  
Figure 23 (Sheet 2 of 3)

GROUP ASSEMBLY PARTS LIST

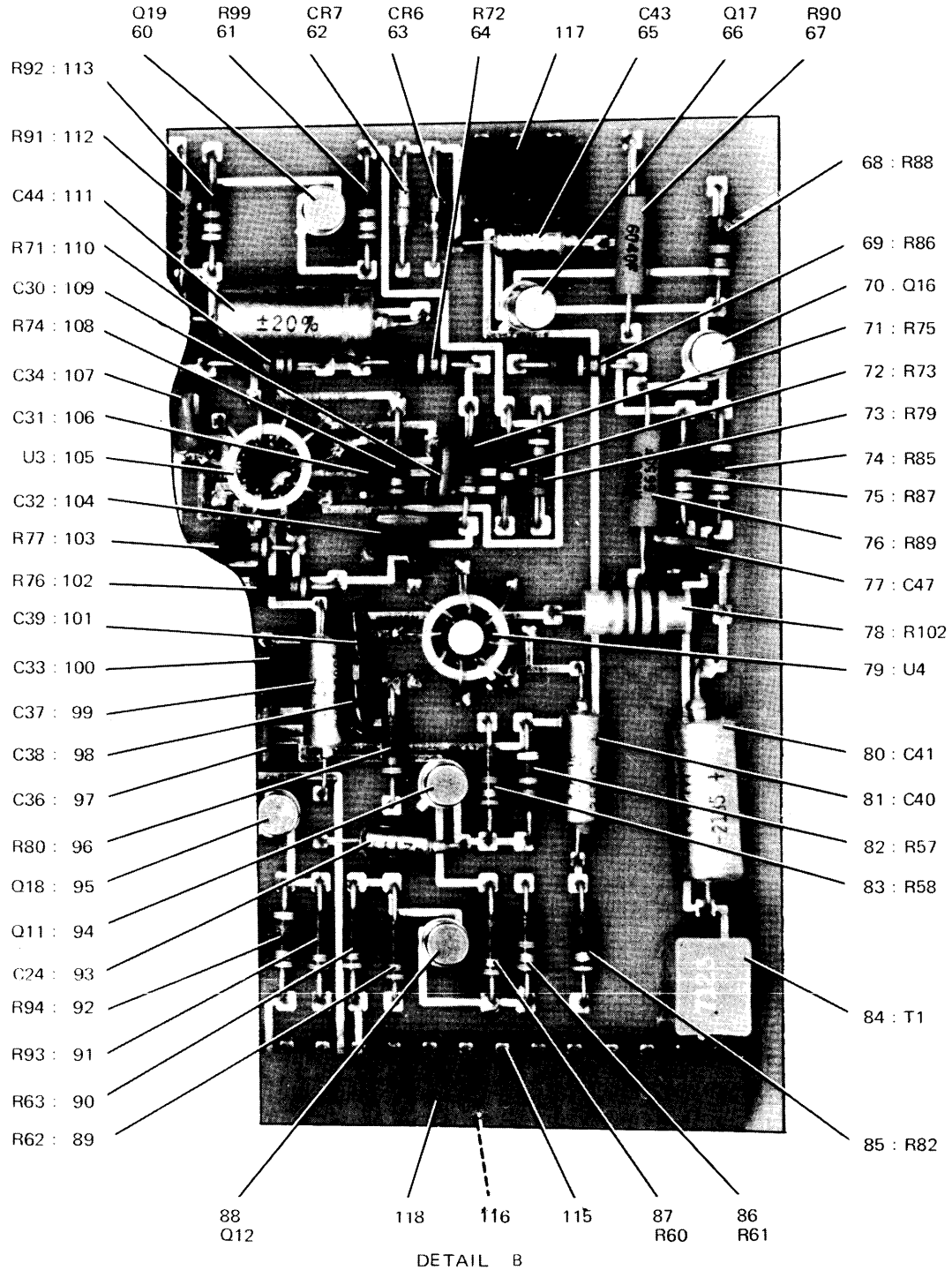

TP3-1038-037

Audio Amplifier Circuit Card Assembly (A2) 778-2948-003, -005  
Figure 23 (Sheet 3 of 3)

GROUP ASSEMBLY PARTS LIST

FIG - ITEM	PART NO	INDENT	DESCRIPTION	USABLE ON CODE	UNITS PER ASSY
23 *	778-2948-003	1	CIRCUIT CARD ASSY, AUDIO AMPLIFIER A2 (SEE FIG 1-23 FOR NHA)	BN	RF
*	778-2948-005	1	CIRCUIT CARD ASSY, AUDIO AMPLIFIER A2 (SEE FIG 1-23 FOR NHA)	BP	RF
1	609-0552-002	2	OSCILLATOR ASSY, VARIABLE BEAT FREQUENCY A2A1 (EFF TO CI 72353) (SEE FIG 32)	BN	1
1	618-7705-001	2	OSCILLATOR ASSY, VARIABLE BEAT FREQUENCY A2A1 (EFF CI 72353) (SEE FIG 33)	BN	1
1	618-7705-002	2	OSCILLATOR ASSY, VARIABLE BEAT FREQUENCY A2A1 (SEE FIG 33)	BP	1
	M551957-2	2	SCREW, MACH, SST, 2-56 X 3/16 (V96906) 343-0123-000 (AP)		6
2	RCR07G223KS	2	RESISTOR, FXD, CMPSN, 22K, 10%, 1/4W (V81349) 745-0797-000 A2R95		1
3	150D476X0020R2	2	CAPACITOR, FXD, ELCTLT, 47UF, 20%, 20V (V56289) 1A4-7664-000 A2C4		1
4	2N2222A	2	TRANSISTOR, (V07688) 352-0661-020 A2Q6		1
5	756-7045-002	2	STRAP, RETAINING		1
	M551957-8	2	SCREW, MACH, SST, 2-56 X 5/8 (V96906) 343-0005-000 (AP)		2
	5610-6-16	2	WASHER, NM, NYL, 0.093 ID X 7/32 OD (V86928) 302-0644-030 (AP)		2
6	RT22C2L103	2	RESISTOR, VAR, WW, 10K, 5%, 3/4W (V81349) 3A1-1721-140 A2R98		1
7	RT22C2L502	2	RESISTOR, VAR, WW, 5K, 5%, 3/4W (V81349) 3A1-1721-120 A2R70		1
8	RCR07G222KS	2	RESISTOR, FXD, CMPSN, 2.2K, 10%, 1/4W (V81349) 745-0761-000 A2R66		1
9	RCR07G103KS	2	RESISTOR, FXD, CMPSN, 10K, 10%, 1/4W (V81349) 745-0785-000 A2R65		1
10	8131-100C0G332K	2	CAPACITOR, FXD, CER DIEL, 3300PF, 10%, 100V (V18796) 913-3281-170 A2C46		1
11	RCR07G332KS	2	RESISTOR, FXD, CMPSN, 3.3K, 10%, 1/4W (V81349) 745-0767-000 A2R64		1
12	2N2608	2	TRANSISTOR, (V07688) 352-0605-010 A2Q15		1
13	RCR07G103KS	2	RESISTOR, FXD, CMPSN, 10K, 10%, 1/4W (V81349) 745-0785-000 A2R69		1
14	2N2222A	2	TRANSISTOR, (V07688) 352-0661-020 A2Q13		1
15	M39003-01-2065	2	CAPACITOR, FXD, ELCTLT, 6.8UF, 20%, 35V (V81349) 184-9083-650 A2C27		1
16	150D475X0035B2	2	CAPACITOR, FXD, ELCTLT, 4.7UF, 20%, 35V (V56289) 184-7396-000 A2C29		1
17	RCR07G562KS	2	RESISTOR, FXD, CMPSN, 5.6K, 10%, 1/4W (V81349) 745-0776-000 A2R68		1
18	2C067103X0101A3	2	CAPACITOR, FXD, CER DIEL, 0.01UF, 20%, 100V (V56289) 913-4240-100 A2C35		1
19	2C067103X0101A3	2	CAPACITOR, FXD, CER DIEL, 0.01UF, 20%, 100V (V56289) 913-4240-100 A2C26		1
20	RCR07G151KS	2	RESISTOR, FXD, CMPSN, 150 OHMS, 10%, 1/4W (V81349) 745-0719-000 A2R78		1
21	2N2222A	2	TRANSISTOR, (V07688) 352-0661-020 A2Q14		1
22	2C067473X0101A3	2	CAPACITOR, FXD, CER DIEL, 0.047UF, 20%, 100V (V56289) 913-4240-080 A2C45		1
23	RCR07G913JS	2	RESISTOR, FXD, CMPSN, 91K, 5%, 1/4W (V81349) 745-0819-000 A2R51		1
24	RCR07G123KS	2	RESISTOR, FXD, CMPSN, 12K, 10%, 1/4W (V81349) 745-0788-000 A2R52		1
25	2N2222A	2	TRANSISTOR, (V07688) 352-0661-020 A2Q9		1
26	RCR07G682KS	2	RESISTOR, FXD, CMPSN, 6.8K, 10%, 1/4W (V81349) 745-0779-000 A2R59		1
27	1N4741	2	SEMICOND DEVICE, (V07688) 353-6481-280 A2VR5		1
28	M39003-01-2111	2	CAPACITOR, FXD, ELCTLT, 0.47UF, 20%, 50V (V81349) 184-9084-380 A2C23		1

## GROUP ASSEMBLY PARTS LIST

FIG - ITEM	PART NO	INDENT	DESCRIPTION	USABLE ON CODE	UNITS PER ASSY
23	29	RCR07G103KS	2 RESISTOR,FXD, CMPSN, 10K, 10%, 1/4W (V81349) 745-0785-000 A2R54		1
	30	RCR07G102KS	2 RESISTOR,FXD, CMPSN, 1K, 10%, 1/4W (V81349) 745-0749-000 A2R53		1
	31	2N2222A	2 TRANSISTOR, (V07688) 352-0661-020 A2Q10		1
	32	RCR07G222KS	2 RESISTOR,FXD, CMPSN, 2.2K, 10%, 1/4W (V81349) 745-0761-000 A2R56		1
	33	RCR07G222KS	2 RESISTOR,FXD, CMPSN, 2.2K, 10%, 1/4W (V81349) 745-0761-000 A2R55		1
	34	M39003-01-2111	2 CAPACITOR,FXD, ELCTLT, 0.47UF, 20%, 50V (V81349) 184-9084-380 A2C22		1
	35	RCR07G222KS	2 RESISTOR,FXD, CMPSN, 2.2K, 10%, 1/4W (V81349) 745-0761-000 A2R50		1
	36	RCR07G222KS	2 RESISTOR,FXD, CMPSN, 2.2K, 10%, 1/4W (V81349) 745-0761-000 A2R49		1
	37	8131-050-651-104 M	2 CAPACITOR,FXD, CER DIEI, 0.1UF, 20%, 50V (V72982) 913-3279-200 A2C2		1
	38	2N2222A	2 TRANSISTOR, (V07688) 352-0661-020 A2Q8		1
	39	RCR07G102KS	2 RESISTOR,FXD, CMPSN, 1K, 10%, 1/4W (V81349) 745-0749-000 A2R45		1
	40	RCR07G103KS	2 RESISTOR,FXD, CMPSN, 10K, 10%, 1/4W (V81349) 745-0785-000 A2R48		1
	41	2C067472X0101A3	2 CAPACITOR,FXD, CER DIEI, 0.0047UF, 20%, 100V (V56289) 913-4240-110 A2C25		1
	42	RCR07G123KS	2 RESISTOR,FXD, CMPSN, 12K, 10%, 1/4W (V81349) 745-0788-000 A2R44		1
	43	RCR07G913JS	2 RESISTOR,FXD, CMPSN, 91K, 5%, 1/4W (V81349) 745-0819-000 A2R84		1
	44	2N2222A	2 TRANSISTOR, (V07688) 352-0661-020 A2Q7		1
	45	RCR07G511JS	2 RESISTOR,FXD, CMPSN, 510 OHMS, 5%, 1/4W (V81349) 745-0738-000 A2R83		1
	46	150D475X0035B2	2 CAPACITOR,FXD, ELCTLT, 4.7UF, 20%, 35V (V56289) 184-7396-000 A2C28		1
	47	2C067103X0101A3	2 CAPACITOR,FXD, CER DIEI, 0.01UF, 20%, 100V (V56289) 913-4240-100 A2C1		1
	48	RCR07G222KS	2 RESISTOR,FXD, CMPSN, 2.2K, 10%, 1/4W (V81349) 745-0761-000 A2R101		1
	49	2N2222A	2 TRANSISTOR, (V07688) 352-0661-020 A2Q20		1
	50	RCR07G222KS	2 RESISTOR,FXD, CMPSN, 2.2K, 10%, 1/4W (V81349) 745-0761-000 A2R100		1
	51	RCR07G222KS	2 RESISTOR,FXD, CMPSN, 2.2K, 10%, 1/4W (V81349) 745-0761-000 A2R67		1
	52	RW69V151	2 RESISTOR,FXD,HW, 150 OHMS, 5%, 3W (V81349) 747-5385-000 A2R1		1
	53	RCR07G104KS	2 RESISTOR,FXD, CMPSN, 0.10MEGO, 10%, 1/4W (V81349) 745-0821-000 A2R98		1
	54	1N914	2 SEMICOND DEVICE, (V07688) 353-2906-000 A2CR9		1
	55	RCR07G472KS	2 RESISTOR,FXD, CMPSN, 4.7K, 10%, 1/4W (V81349) 745-0773-000 A2R39		1
	56	RCR07G105KS	2 RESISTOR,FXD, CMPSN, 1MEGO, 10%, 1/4W (V81349) 745-0857-000 A2R97		1
	57	1N4733	2 SEMICOND DEVICE, (V07688) 353-6481-120 A2VR1		1
	58	RCR07G472KS	2 RESISTOR,FXD, CMPSN, 4.7K, 10%, 1/4W (V81349) 745-0773-000 A2R42		1
	59	1N914	2 SEMICOND DEVICE, (V07688) 353-2906-000 A2CR8		1
	60	2N2222A	2 TRANSISTOR, (V07688) 352-0661-020 A2Q19		1
	61	RCR07G103KS	2 RESISTOR,FXD, CMPSN, 10K, 10%, 1/4W (V81349) 745-0785-000 A2R99		1
	62	1N914	2 SEMICOND DEVICE, (V07688) 353-2906-000 A2CR7		1
	63	1N914	2 SEMICOND DEVICE, (V07688) 353-2906-000 A2CR6		1
	64	RCR07G274KS	2 RESISTOR,FXD, CMPSN, 0.27MEGO, 10%, 1/4W (V81349) 745-0836-000 A2R72		1

GROUP ASSEMBLY PARTS LIST

FIG - ITEM	PART NO	INDENT	DESCRIPTION	USABLE ON CODE	UNITS PER ASSY
23 65	M39003-01-2044	2	CAPACITOR,FXD, ELCTLT, 2.2UF, 20%, 20V (V81349) 184-9083-440 A2C43		1
66	2N2222A	2	TRANSISTOR, (V07688) 352-0661-020 A2Q17		1
67	RN60D6040F	2	RESISTOR,FXD, FILM, 604 OHMS, 1%, 1/4W (V81349) 705-3603-700 A2R90		1
68	RCR07G153JS	2	RESISTOR,FXD, CMPSN, 15K, 5%, 1/4W (V81349) 745-0790-000 A2R88		1
69	RCR07G124JS	2	RESISTOR,FXD, CMPSN, 0.12MEGO, 5%, 1/4W (V81349) 745-0823-000 A2R86		1
70	2N2222A	2	TRANSISTOR, (V07688) 352-0661-020 A2Q16		1
71	RCR07G202JS	2	RESISTOR,FXD, CMPSN, 2K, 5%, 1/4W (V81349) 745-0759-000 A2R75		1
72	RCR07G151KS	2	RESISTOR,FXD, CMPSN, 150 OHMS, 10%, 1/4W (V81349) 745-0719-000 A2R73		1
73	RCR07G681JS	2	RESISTOR,FXD, CMPSN, 680 OHMS, 5%, 1/4W (V81349) 745-0742-000 A2R79		1
74	RCR07G473KS	2	RESISTOR,FXD, CMPSN, 47K, 10%, 1/4W (V81349) 745-0809-000 A2R85		1
75	RCR07G103KS	2	RESISTOR,FXD, CMPSN, 10K, 10%, 1/4W (V81349) 745-0785-000 A2R87		1
76	RN60D6650F	2	RESISTOR,FXD, FILM, 665 OHMS, 1%, 1/4W (V81349) 705-3603-710 A2R89		1
77	2C067103X0101A3	2	CAPACITOR,FXD, CER DIEI, 0.01UF, 20%, 100V (V56289) 913-4240-100 A2C47		1
78	MS90539-15	2	COIL,RF, 100UH (V96906) 240-2540-000 A2L1 (EFF TO CI 72373)	BN	1
78	RCR07G101KS	2	RESISTOR,FXD, CMPSN, 100 OHMS, 10%, 1/4W (V81349) 745-0713-000 A2R102 (EFF CI 72373)	BN	1
78	RCR07G101KS	2	RESISTOR,FXD, CMPSN, 100 OHMS, 10%, 1/4W (V81349) 745-0713-000 A2R102	BP	1
79	USB771639J	2	INTEGRATED CKT, (V07263) 351-1008-010 A2I14		1
80	M39003-01-2135	2	CAPACITOR,FXD, ELCTLT, 10UF, 20%, 50V (V81349) 184-9084-620 A2C41		1
81	150D475X0035B2	2	CAPACITOR,FXD, ELCTLT, 4.7UF, 20%, 35V (V56289) 184-7396-000 A2C40		1
82	RCR07G913JS	2	RESISTOR,FXD, CMPSN, 91K, 5%, 1/4W (V81349) 745-0819-000 A2R57		1
83	RCR07G123KS	2	RESISTOR,FXD, CMPSN, 12K, 10%, 1/4W (V81349) 745-0788-000 A2R58		1
84	SP67	2	TRANSFORMER,AF, (V81095) 677-1684-000 A2T1		1
85	RCR07G182KS	2	RESISTOR,FXD, CMPSN, 1.8K, 10%, 1/4W (V81349) 745-0758-000 A2R82		1
86	RCR07G103KS	2	RESISTOR,FXD, CMPSN, 10K, 10%, 1/4W (V81349) 745-0785-000 A2R61		1
87	RCR07G102KS	2	RESISTOR,FXD, CMPSN, 1K, 10%, 1/4W (V81349) 745-0749-000 A2R60		1
88	2N2222A	2	TRANSISTOR, (V07688) 352-0661-020 A2Q12		1
89	RCR07G222KS	2	RESISTOR,FXD, CMPSN, 2.2K, 10%, 1/4W (V81349) 745-0761-000 A2R62		1
90	RCR07G222KS	2	RESISTOR,FXD, CMPSN, 2.2K, 10%, 1/4W (V81349) 745-0761-000 A2R63		1
91	RCR07G222KS	2	RESISTOR,FXD, CMPSN, 2.2K, 10%, 1/4W (V81349) 745-0761-000 A2R93		1
92	RCR07G472KS	2	RESISTOR,FXD, CMPSN, 4.7K, 10%, 1/4W (V81349) 745-0773-000 A2R94		1
93	M39003-01-2111	2	CAPACITOR,FXD, ELCTLT, 0.47UF, 20%, 50V (V81349) 184-9084-380 A2C24		1
94	2N2222A	2	TRANSISTOR, (V07688) 352-0661-020 A2Q11		1
95	2N2222A	2	TRANSISTOR, (V07688) 352-0661-020 A2Q18		1
96	RCR07G750JS	2	RESISTOR,FXD, CMPSN, 75 OHMS, 5%, 1/4W (V81349) 745-0708-000 A2R80		1
97	8131-050-651-104 M	2	CAPACITOR,FXD, CER DIEI, 0.1UF, 20%, 50V (V72982) 913-3279-200 A2C36		1



## GROUP ASSEMBLY PARTS LIST

FIG - ITEM	PART NO	INDENT	DESCRIPTION	USABLE ON CODE	UNITS PER ASSY
23	98	DM5E680J050WV	2 CAPACITOR,FXD, MICA DIEI, 68PF, 5%, 50V (V72136) 912-4141-330 A2C38		1
	99	150D475X0035B2	2 CAPACITOR,FXD, ELCTLT, 4.7UF, 20%, 35V (V56289) 184-7396-000 A2C37		1
	100	K058K102M	2 CAPACITOR,FXD, CER DIEI, 1000PF, 10%, 100V (V05397) 913-4489-360 A2C33		1
	101	DM5E430J050WV	2 CAPACITOR,FXD, MICA DIEI, 43PF, 5%, 50V (V72136) 912-4141-260 A2C39		1
	102	RCR07G202JS	2 RESISTOR,FXD, CMPSN, 2K, 5%, 1/4W (V81349) 745-0759-000 A2R76		1
	103	RCR07G202JS	2 RESISTOR,FXD, CMPSN, 2K, 5%, 1/4W (V81349) 745-0759-000 A2R77		1
	104	2C067473X0101A3	2 CAPACITOR,FXD, CER DIEI, 0.047UF, 20%, 100V (V56289) 913-4240-080 A2C32		1
	105	MC1435G	2 INTEGRATED CKT, (V04713) 351-1034-020 A2113		1
	106	K058K102M	2 CAPACITOR,FXD, CER DIEI, 1000PF, 10%, 100V (V05397) 913-4489-360 A2C31		1
	107	2C067472X0101A	2 CAPACITOR,FXD, CER DIEI, 0.0047UF, 20%, 100V (V56289) 913-4240-110 A2C34		1
	108	RCR07G682KS	2 RESISTOR,FXD, CMPSN, 6.8K, 10%, 1/4W (V81349) 745-0779-000 A2R74		1
	109	2C067103X0101A3	2 CAPACITOR,FXD, CER DIEI, 0.01UF, 20%, 100V (V56289) 913-4240-100 A2C30		1
	110	RCR07G103KS	2 RESISTOR,FXD, CMPSN, 10K, 10%, 1/4W (V81349) 745-0785-000 A2R71		1
	111	150D476X0020R2	2 CAPACITOR,FXD, ELCTLT, 47UF, 20%, 20V (V56289) 184-7664-000 A2C44		1
		609-2792-001	2 RESISTOR KIT, (NON-PROCURABLE ITEM)	BN	1
	112	T055-8-25K1F	3 RESISTOR, FXD, FILM, 8.25K, 1%, 1/8W (V11502) 705-1454-610 A2R91		AR
	112	T055-9-09K1F	3 RESISTOR, FXD, FILM 9.09K, 1%, 1/8W (V11502) 705-1454-620 A2R91		AR
	112	T055-8661-1F	3 RESISTOR, FXD, FILM, 8.66K, 1%, 1/8W (V11502) 705-1470-850 A2R91		AR
	112	T055-9531-1F	3 RESISTOR, FXD, FILM, 9.53K, 1%, 1/8W (V11502) 705-1470-860 A2R91		AR
	112	T055-9-09K1F	2 RESISTOR,FXD, FILM, 9.09K, 1%, 1/8W (V11502) 705-1454-620 A2R91	BP	1
	113	RCR07G223KS	2 RESISTOR,FXD, CMPSN, 22K, 10%, 1/4W (V81349) 745-0797-000 A2R92		1
	114	372-2601-026	2 CONTACT,ELEC, 372-2601-026		6
	115	372-2234-020	2 CONTACT,ELEC, (V13499) 372-2234-020		21
	116	372-2234-010	2 CONTACT,ELEC, (V13499) 372-2234-010		21
	117	372-2621-012	2 HOUSING,CONN, 372-2621-012		1
	118	372-2623-037	2 HOUSING,CONN,EL, 372-2623-037		1
	119	790-2768-003	2 HANDLE	BN	1
	119	790-2768-005	2 HANDLE	BP	1
		M551923-314	2 PIN,SPRING, SST, 0.078 DIA X 1/4 (V96906) 311-0465-000 (AP)		1
24		778-2949-001	1 CIRCUIT CARD ASSY, POWER SUPPLY REGULATOR A1 (SEE FIG 1-24 FOR NHA)		RF
	1	CM04FD181J03	2 CAPACITOR,FXD, MICA DIEI, 180PF, 5%, 500V (V81349) 912-3897-000 A1C13		1
	2	RCR07G222KS	2 RESISTOR,FXD, CMPSN, 2.2K, 10%, 1/4W (V81349) 745-0761-000 A1R26		1
	3	CB1028	2 SEMICOND DEVICE, (V08732) 353-3653-010 A106		1

GROUP ASSEMBLY PARTS LIST

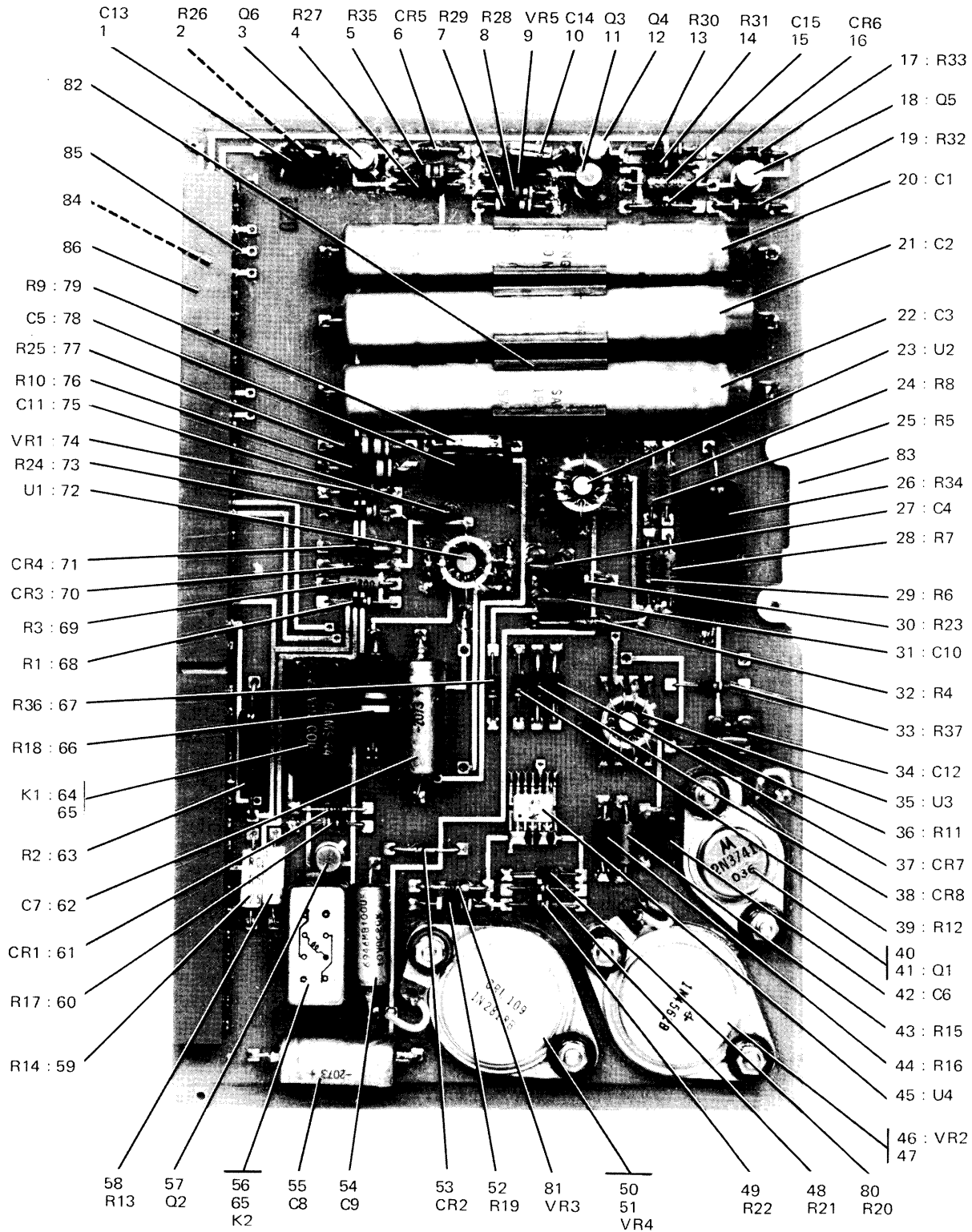

TP3-1039-017

Power Supply Regulator Circuit Card Assembly (A1) 778-2949-001  
 Figure 24

GROUP ASSEMBLY PARTS LIST

FIG - ITEM	PART NO	INDENT	DESCRIPTION	USABLE ON CODE	UNITS PER ASSY
24	4	RCR07G120KS	2 RESISTOR,FXD, CMPSN, 12 OHMS, 10%, 1/4W (V81349) 745-0680-000 A1R27		1
	5	RCR07G124KS	2 RESISTOR,FXD, CMPSN, 0.12MEGO, 10%, 1/4W (V81349) 745-0824-000 A1R35		1
	6	1N914	2 SEMICOND DEVICE, (V07688) 353-2906-000 A1CR5		1
	7	RCR07G472KS	2 RESISTOR,FXD, CMPSN, 4.7K, 10%, 1/4W (V81349) 745-0773-000 A1R29		1
	8	RCR07G473KS	2 RESISTOR,FXD, CMPSN, 47K, 10%, 1/4W (V81349) 745-0809-000 A1R28		1
	9	1N753A	2 SEMICOND DEVICE, (V81350) 353-2980-000 A1VR5		1
	10	CK06BX394K	2 CAPACITOR,FXD, CER DIEL, 0.39UF, 10%, 50V (V81349) 913-5019-510 A1C14		1
	11	2N2222A	2 TRANSISTOR, (V81350) 352-7500-280 A1Q3		1
	12	2N2222A	2 TRANSISTOR, (V81350) 352-7500-280 A1Q4		1
	13	RCR07G183KS	2 RESISTOR,FXD, CMPSN, 18K, 10%, 1/4W (V81349) 745-0794-000 A1R30		1
	14	RCR07G272KS	2 RESISTOR,FXD, CMPSN, 2.7K, 10%, 1/4W (V81349) 745-0764-000 A1R31		1
	15	M39003-01-2108	2 CAPACITOR,FXD, ELCTLT, 0.33UF, 20%, 50V (V81349) 184-9084-350 A1C15		1
	16	1N914	2 SEMICOND DEVICE, (V07688) 353-2906-000 A1CR6		1
	17	RCR07G680KS	2 RESISTOR,FXD, CMPSN, 68 OHMS, 10%, 1/4W (V81349) 745-0707-000 A1R33		1
	18	2N2222A	2 TRANSISTOR, (V81350) 352-7500-280 A1Q5		1
	19	RCR07G472KS	2 RESISTOR,FXD, CMPSN, 4.7K, 10%, 1/4W (V81349) 745-0773-000 A1R32		1
	20	600D187G050DX5	2 CAPACITOR,FXD, ELCTLT, 180 UF, M10XP75%, 50V (V56289) 183-1277-790 A1C1		1
	21	600D187G050DX5	2 CAPACITOR,FXD, ELCTLT, 180 UF, M10XP75%, 50V (V56289) 183-1277-790 A1C2		1
	22	600D187G050DX5	2 CAPACITOR,FXD, ELCTLT, 180 UF, M10XP75%, 50V (V56289) 183-1277-790 A1C3		1
	23	U5R7723393	2 INTEGRATED CKT, (V07263) 351-1035-020 A1U2		1
	24	T055-3011-1F	2 RESISTOR,FXD, FILM, 3.01K, 1%, 1/8W (V11502) 705-1470-740 A1R8		1
	25	T055-3011-1F	2 RESISTOR,FXD, FILM, 3.01K, 1%, 1/8W (V11502) 705-1470-740 A1R5		1
	26	RW67V221	2 RESISTOR,FXD,WW, 220 OHMS, 5%, 6.5W (V81349) 747-5447-000 A1R34		1
	27	8131-050-651-104	2 CAPACITOR,FXD, CER DIEL, 0.1UF, 20%, 50V (V72982) 913-3279-200 A1C4 (EFF TO CI 73116)		1
	27	D71F511G0	2 CAPACITOR, FXD, MICA DIEL, 510PF, 2%, 100V (V00853) 912-2093-030 A1C4 (EFF CI 73116)		1
	28	T055-5-62K1F	2 RESISTOR,FXD, FILM, 5.62K, 1%, 1/8W (V11502) 705-1454-570 A1R7		1
	29	T055-17-8K1F	2 RESISTOR,FXD, FILM, 17.8K, 1%, 1/8W (V11502) 705-1454-690 A1R6		AR
	29	T055-1692-1F	2 RESISTOR,FXD, FILM, 16.9K, 1%, 1/8W (V11502) 705-1470-930 A1R6		AR
	29	T055-17400-1F	2 RESISTOR,FXD, FILM, 17.4K, 1%, 1/10W (V11502) 705-1468-520 A1R6		AR
	29	T055-18200-1F	2 RESISTOR,FXD, FILM, 18.2K, 1%, 1/8W (V11502) 705-1468-530 A1R6		AR
	29	T055-1872-1F	2 RESISTOR,FXD, FILM, 18.7K, 1%, 1/8W (V11502) 705-1470-940 A1R6		AR
	30	RCR07G180KS	2 RESISTOR,FXD, CMPSN, 18 OHMS, 10%, 1/4W (V81349) 745-0686-000 A1R23		1
	31	2C067103X0101A3	2 CAPACITOR,FXD, CER DIEL, 0.01UF, 20%, 100V (V56289) 913-4240-100 A1C10		1
	32	T055-4-64K1F	2 RESISTOR,FXD, FILM, 4.64K, 1%, 1/8W (V11502) 705-1454-550 A1R4		AR
	32	T055-5-11K1F	2 RESISTOR,FXD, FILM, 5.11K, 1%, 1/8W (V11502) 705-1454-560 A1R4		AR
	32	T055-5-62K1F	2 RESISTOR,FXD, FILM, 5.62K, 1%, 1/8W (V11502) 705-1454-570 A1R4		AR

## GROUP ASSEMBLY PARTS LIST

FIG - ITEM	PART NO	INDENT	DESCRIPTION	USABLE ON CODE	UNITS PER ASSY
24	32	T055-4530-1F	2 RESISTOR,FXD, FILM, 4.53K, 1%, 1/8W (V11502) 705-1468-250 A1R4		AR
	32	T055-4750-1F	2 RESISTOR,FXD, FILM, 4.75K, 1%, 1/8W (V11502) 705-1468-260 A1R4		AR
	32	T055-4990-1F	2 RESISTOR,FXD, FILM, 4.99K, 1%, 1/8W (V11502) 705-1468-270 A1R4		AR
	32	T055-5230-1F	2 RESISTOR,FXD, FILM, 5.23K, 1%, 1/8W (V11502) 705-1468-280 A1R4		AR
	32	T055-5490-1F	2 RESISTOR,FXD, FILM, 5.49K, 1%, 1/8W (V11502) 705-1468-290 A1R4		AR
	32	T055-5760-1F	2 RESISTOR,FXD, FILM, 5.76K, 1%, 1/8W (V11502) 705-1468-300 A1R4		AR
	32	T055-4421-1F	2 RESISTOR,FXD, FILM, 4.42K, 1%, 1/8W (V11502) 705-1470-780 A1R4		AR
	32	T055-4871-1F	2 RESISTOR,FXD, FILM, 4.87K, 1%, 1/8W (V11502) 705-1470-790 A1R4		AR
	32	T055-5361-1F	2 RESISTOR,FXD, FILM, 5.36K, 1%, 1/8W (V11502) 705-1470-800 A1R4		AR
	32	T055-5901-1F	2 RESISTOR,FXD, FILM, 5.9K, 1%, 1/8W (V11502) 705-1470-810 A1R4		AR
	33	RCR07G102XS	2 RESISTOR,FXD, CMPSN, 1K, 10%, 1/4W (V81349) 745-0749-000 A1R37		1
	34	2C067103X0101A3	2 CAPACITOR,FXD, CER DIEL, 0.01UF, 20%, 100V (V56289) 913-4240-100 A1C12		1
	35	USR7723393	2 INTEGRATED CKT, (V07263) 351-1035-020 A1U3		1
	36	RCR07G101KS	2 RESISTOR,FXD, CMPSN, 100 OHMS, 10%, 1/4W (V81349) 745-0713-000 A1R11		1
	37	1N4003	2 SEMICOND DEVICE, (V04713) 353-6442-030 A1CR7		1
	38	1N4003	2 SEMICOND DEVICE, (V04713) 353-6442-030 A1CR8		1
	39	RCR07G101KS	2 RESISTOR,FXD, CMPSN, 100 OHMS, 10%, 1/4W (V81349) 745-0713-000 A1R12		1
	40	2N3741	2 TRANSISTOR, (V07688) 352-0695-020 A1D1		1
	41	TA2402A	2 INSULATOR,PL, (V08289) 352-9570-020		1
		P313-0132-000	2 NUT,PLATN,HEX, SST, 4-40 (V77250) 313-0132-000 (AP FOR 40,41)		2
		4704-04-01-4102	2 WASHER,LOCK, SST, 0.124 ID X 0.275 OD (V78189) 373-0154-000 (AP FOR 40,41)		2
		547-8177-006	2 BUSHING, (AP FOR 40,41)		2
		4007-6HT	2 TERMINAL,LUG, (V77147) 304-0016-000 (AP FOR 40,41)		1
		MS51957-16	2 SCREW,MACH, STL, 4-40 X 7/16 (V96906) 343-0136-000 (AP FOR 40,41)		2
	42	8131-050-651-104 M	2 CAPACITOR,FXD, CER DIEL, 0.1UF, 20%, 50V (V72982) 913-3279-200 A1C6		1
	43	T055-1-96K1F	2 RESISTOR,FXD, FILM, 1.96K, 1%, 1/8W (V11502) 705-1454-460 A1R15		1
	44	T055-4-64K1F	2 RESISTOR,FXD, FILM, 4.64K, 1%, 1/8W (V11502) 705-1454-550 A1R16		AR
	44	T055-5-11K1F	2 RESISTOR,FXD, FILM, 5.11K, 1%, 1/8W (V11502) 705-1454-560 A1R16		AR
	44	T055-5-62K1F	2 RESISTOR,FXD, FILM, 5.62K, 1%, 1/8W (V11502) 705-1454-570 A1R16		AR
	44	T055-4530-1F	2 RESISTOR,FXD, FILM, 4.53K, 1%, 1/8W (V11502) 705-1468-250 A1R16		AR
	44	T055-4750-1F	2 RESISTOR,FXD, FILM, 4.75K, 1%, 1/8W (V11502) 705-1468-260 A1R16		AR
	44	T055-4990-1F	2 RESISTOR,FXD, FILM, 4.99K, 1%, 1/8W (V11502) 705-1468-270 A1R16		AR
	44	T055-5230-1F	2 RESISTOR,FXD, FILM, 5.23K, 1%, 1/8W (V11502) 705-1468-280 A1R16		AR
	44	T055-5490-1F	2 RESISTOR,FXD, FILM, 5.49K, 1%, 1/8W (V11502) 705-1468-290 A1R16		AR

## GROUP ASSEMBLY PARTS LIST

FIG - ITEM	PART NO	INDENT	DESCRIPTION	USABLE ON CODE	UNITS PER ASSY
24	44	T055-5760-1F	2 RESISTOR,FXD, FILM, 5.76K, 1%, 1/8W (V11502) 705-1468-300 A1R16		AR
	44	T055-4421-1F	2 RESISTOR,FXD, FILM, 4.42K, 1%, 1/8W (V11502) 705-1470-780 A1R16		AR
	44	T055-4871-1F	2 RESISTOR,FXD, FILM, 4.87K, 1%, 1/8W (V11502) 705-1470-790 A1R16		AR
	44	T055-5361-1F	2 RESISTOR,FXD, FILM, 5.36K, 1%, 1/8W (V11502) 705-1470-800 A1R16		AR
	44	T055-5901-1F	2 RESISTOR,FXD, FILM, 5.9K, 1%, 1/8W (V11502) 705-1470-810 A1R16		AR
	45	SG41	2 INTEGRATED CKT, (V93332) 351-7077-020 A1114		1
	46	1N4562B	2 SEMICOND DEVICE, (V07688) 353-6510-060 A1VR2		1
	47	DM115	2 INSULATOR,PLATE, (V08289) 352-9882-010		1
		P313-0132-000	2 NUT,PLAIN,HEX, SST, 4-40 (V77250) 313-0132-000 (AP FOR 46,47)		2
		4704-04-01-4102	2 WASHER,LOCK, SST, 0.124 ID X 0.275 OD (V78189) 373-0154-000 (AP FOR 46,47)		2
		547-8177-003	2 BUSHING, (AP FOR 46,47)		2
		4007-6HT	2 TERMINAL,LUG, (V77147) 304-0016-000 (AP FOR 46,47)		1
		MS51957-16	2 SCREW,MACH, STL, 4-40 X 7/16 (V96906) 343-0136-000 (AP FOR 46,47)		2
	48	RCR05G681K	2 RESISTOR,FXD, CMPSN, 680 OHMS, 10%, 1/8W (V81349) 745-2335-000 A1R21		1
	49	RCR05G103K	2 RESISTOR,FXD, CMPSN, 10K, 10%, 1/8W (V81349) 745-2377-000 A1R22		1
	50	1N2818B	2 SEMICOND DEVICE, (V04713) 353-1411-000 A1VR4		1
	51	DM115	2 INSULATOR,PLATE, (V08289) 352-9882-010		1
		P313-0132-000	2 NUT,PLAIN,HEX, SST, 4-40 (V77250) 313-0132-000 (AP FOR 50,51)		2
		4704-04-01-4102	2 WASHER,LOCK, SST, 0.124 ID X 0.275 OD (V78189) 373-0154-000 (AP FOR 50,51)		2
		547-8177-003	2 BUSHING, (AP FOR 50,51)		2
		4007-6HT	2 TERMINAL,LUG, (V77147) 304-0016-000 (AP FOR 50,51)		1
		MS51957-16	2 SCREW,MACH, STL, 4-40 X 7/16 (V96906) 343-0136-000 (AP FOR 50,51)		2
	52	RCR07G472KS	2 RESISTOR,FXD, CMPSN, 4.7K, 10%, 1/4W (V81349) 745-0773-000 A1R19		1
	53	1N914	2 SEMICOND DEVICE, (V07688) 353-2906-000 A1CR2		1
	54	M39003-01-2022	2 CAPACITOR,FXD, ELCTLT, 100UF, 20%, 10V (V81349) 184-9083-220 A1C9		1
	55	M39003-01-2073	2 CAPACITOR,FXD, ELCTLT, 47UF, 20%, 35V (V81349) 184-9083-730 A1C8		1
	56	3SAV1119A2	2 RELAY,AMT, (V01526) 974-1065-120 A1K2		1
	57	2N2222A	2 TRANSISTOR, (V81350) 352-7500-280 A1Q2		1
	58	R#70UR237F	2 RESISTOR,FXD,HW, 0.237 OHMS, 1%, 1W (V81349) 747-1499-220 A1R13		1
	59	R#70UR237F	2 RESISTOR,FXD,HW, 0.237 OHMS, 1%, 1W (V81349) 747-1499-220 A1R14		1
	60	RCR05G391K	2 RESISTOR,FXD, CMPSN, 390 OHMS, 10%, 1/8W (V81349) 745-2326-000 A1R17		1
	61	1N914	2 SEMICOND DEVICE, (V07688) 353-2906-000 A1CR1		1
	62	M39003-01-2073	2 CAPACITOR,FXD, ELCTLT, 47UF, 20%, 35V (V81349) 184-9083-730 A1C7		1
	63	RS2B00FR4000F	2 RESISTOR,FXD,HW, 0.4 OHMS, 1%, 3W (V91637) 747-1988-130 A1R2		1
	64	3SAV1119A2	2 RELAY,AMT, (V01526) 974-1065-120 A1K1		1
	65	RCRP800060-2A	2 INSULATOR, (V19080) 150-0684-020		2
	66	RCR32G121KS	2 RESISTOR,FXD, CMPSN, 120 OHMS, 10%, 1W (V81349) 745-3314-000 A1R18		1
	67	RCR07G102KS	2 RESISTOR,FXD, CMPSN, 1K, 10%, 1/4W (V81349) 745-0749-000 A1R36		1

GROUP ASSEMBLY PARTS LIST

FIG - ITEM	PART NO	INDENT	DESCRIPTION	USABLE ON CODE	UNITS PER ASSY
24 68	RCR07G101KS	2	RESISTOR,FXD, CMPSN, 100 OHMS, 10%, 1/4W (V81349) 745-0713-000 A1R1		1
69	T055-5-62K1F	2	RESISTOR,FXD, FILM, 5.62K, 1%, 1/8W (V11502) 705-1454-570 A1R3		1
70	1N4003	2	SEMICOND DEVICE, (V04713) 353-6442-030 A1CR3		1
71	1N4003	2	SEMICOND DEVICE, (V04713) 353-6442-030 A1CR4		1
72	U5R7723393	2	INTEGRATED CKT, (V07263) 351-1035-020 A1U1		1
73	RCR07G270KS	2	RESISTOR,FXD, CMPSN, 27 OHMS, 10%, 1/4W (V81349) 745-0692-000 A1R24		1
74	1N753A	2	SEMICOND DEVICE, (V81350) 353-2980-000 A1VR1		1
75	2C067103X0101A3	2	CAPACITOR,FXD, CER DIEL, 0.01UF, 20%, 100V (V56289) 913-4240-100 A1C11		1
76	RCR20G122KS	2	RESISTOR,FXD, CMPSN, 1.2K, 10%, 1/2W (V81349) 745-1356-000 A1R10		1
77	RCR20G103KS	2	RESISTOR,FXD, CMPSN, 10K, 10%, 1/2W (V81349) 745-1394-000 A1R25		1
78	CM06FD511J03	2	CAPACITOR,FXD, MICA DIEL, 510PF, 5%, 500V (V81349) 912-2980-000 A1C5		1
79	RW70UR237F	2	RESISTOR,FXD,WW, 0.237 OHMS, 1%, 1W (V81349) 747-1499-220 A1R9		1
80	RCR05G272K	2	RESISTOR,FXD, CMPSN, 2.7K, 10%, 1/8W (V81349) 745-2356-000 A1R20		1
81	1N750A	2	SEMICOND DEVICE, (V07688) 353-2708-000 A1VR3		1
82	100-200-7-0 MS16535-77	2	CLIP,SPR TNSN, (V99378) 139-0747-000		3
		2	RIVET,TUBULAR, AL, 0.089 DIA X 0.156 (V96906) 305-1756-000 (AP)		6
83	790-2769-001 MS51923-314	2	HANDLE		1
		2	PIN,SPRING, SST, 0.078 DIA X 1/4 (V96906) 311-0465-000 (AP)		1
84	372-2234-010	2	CONTACT,ELEC, (V13499) 372-2234-010		24
85	372-2234-020	2	CONTACT,ELEC, (V13499) 372-2234-020		23
86	372-2623-048	2	HOUSING,CONN,EL, 372-2623-048		1

GROUP ASSEMBLY PARTS LIST

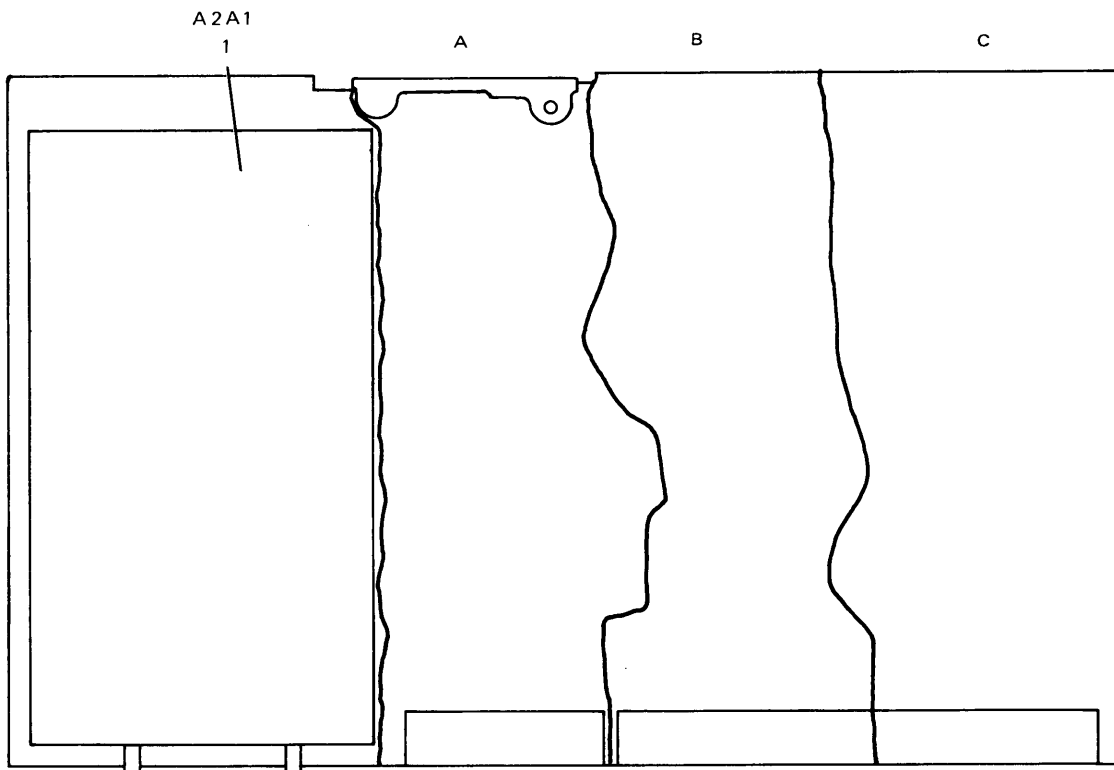

TP3-1040-047

Audio Amplifier Circuit Card Assembly (A2) 778-2948-002, -004  
Figure 25 (Sheet 1 of 4)

FIG - ITEM	PART NO	INDENT	DESCRIPTION	USABLE ON CODE	UNITS PER ASSY
25 -	778-2948-002	1	CIRCUIT CARD ASSY, AUDIO AMPLIFIER A2 (SEE FIG 1-23 FOR NHA)	BQ	RF
-	778-2948-004	1	CIRCUIT CARD ASSY, AUDIO AMPLIFIER A2 (SEE FIG 1-23 FOR NHA)	BR	RF
1	609-0552-001	2	OSCILLATOR ASSY, VARIABLE BEAT FREQUENCY A2A1 (SEE FIG 32) (EFF TO CI 72133)	BQ	1
1	609-0552-002	2	OSCILLATOR ASSY, VARIABLE BEAT FREQUENCY A2A1 (SEE FIG 32) (EFF CI 72133)	BQ	1
1	618-7705-001	2	OSCILLATOR ASSY, VARIABLE BEAT FREQUENCY A2A1 (SEE FIG 33)	BR	1
	M551957-2	2	SCREW, MACH, SST, 2-56 X 3/16 (V96906)		6
	310-6320-000	2	343-0123-000 (AP) WASHER, FLAT, SST, 0,092 ID X 0,218 OD (V79807)	BR	6
	8942	2	310-6320-000 (AP) (EFF CI 72446) WASHER, NM, PHEN, 0,116 ID X 0,187 OD (V76854)	BR	1
2	150D475X0035B2	2	302-0262-000 (AP) (EFF CI 72446) CAPACITOR, FXD, ELCTLT, 4,7UF, 20%, 35V (V56289)		1
3	RCR07G511JS	2	184-7396-000 A2C11 RESISTOR, FXD, CMPSN, 510 OHMS, 5%, 1/4W (V81349)		1
4	RCR07G513JS	2	745-0738-000 A2R2 RESISTOR, FXD, CMPSN, 51K, 5%, 1/4W (V81349)		1
			745-0810-000 A2R3		

GROUP ASSEMBLY PARTS LIST

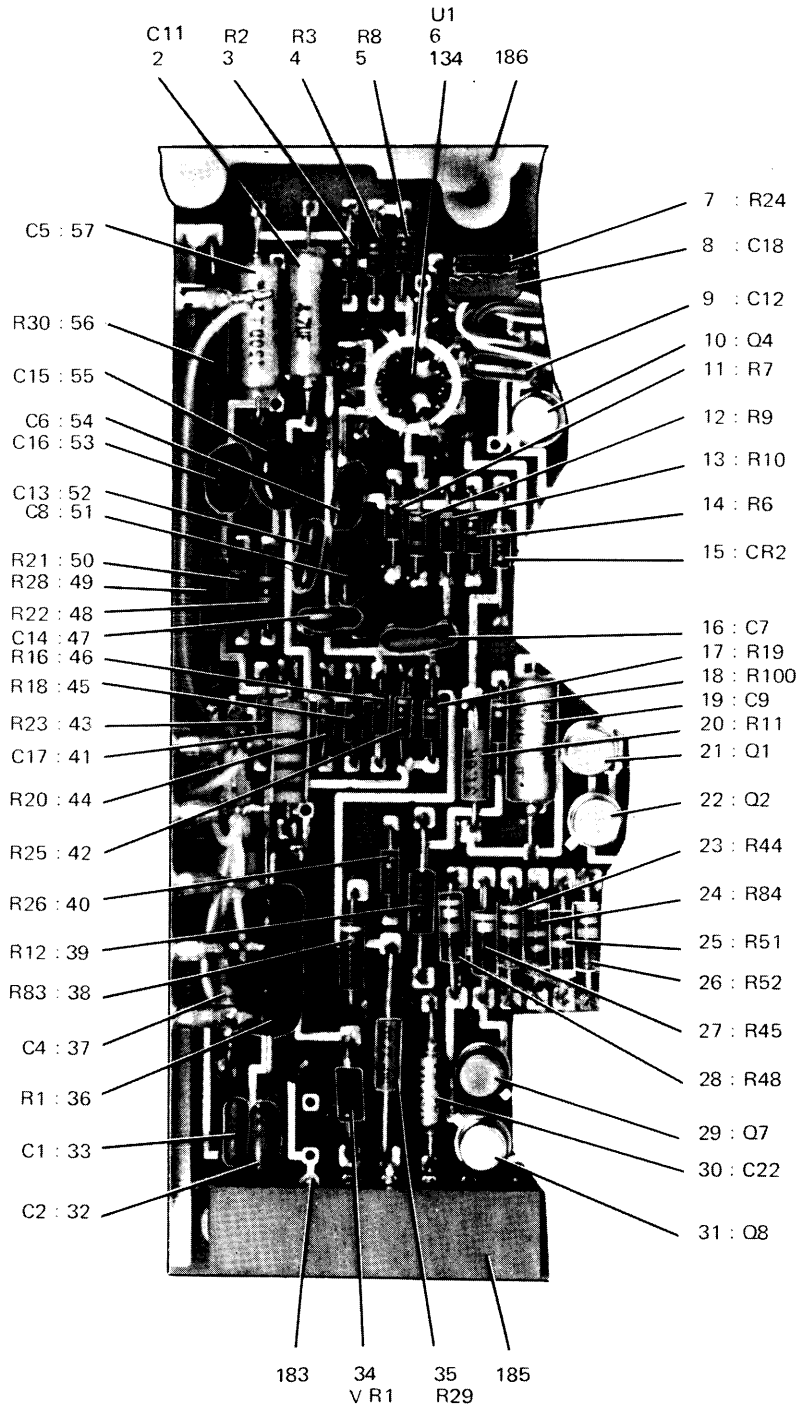

DETAIL A

TP3-1040-047

Audio Amplifier Circuit Card Assembly (A2) 778-2948-002, -004  
Figure 25 (Sheet 2 of 4)



GROUP ASSEMBLY PARTS LIST

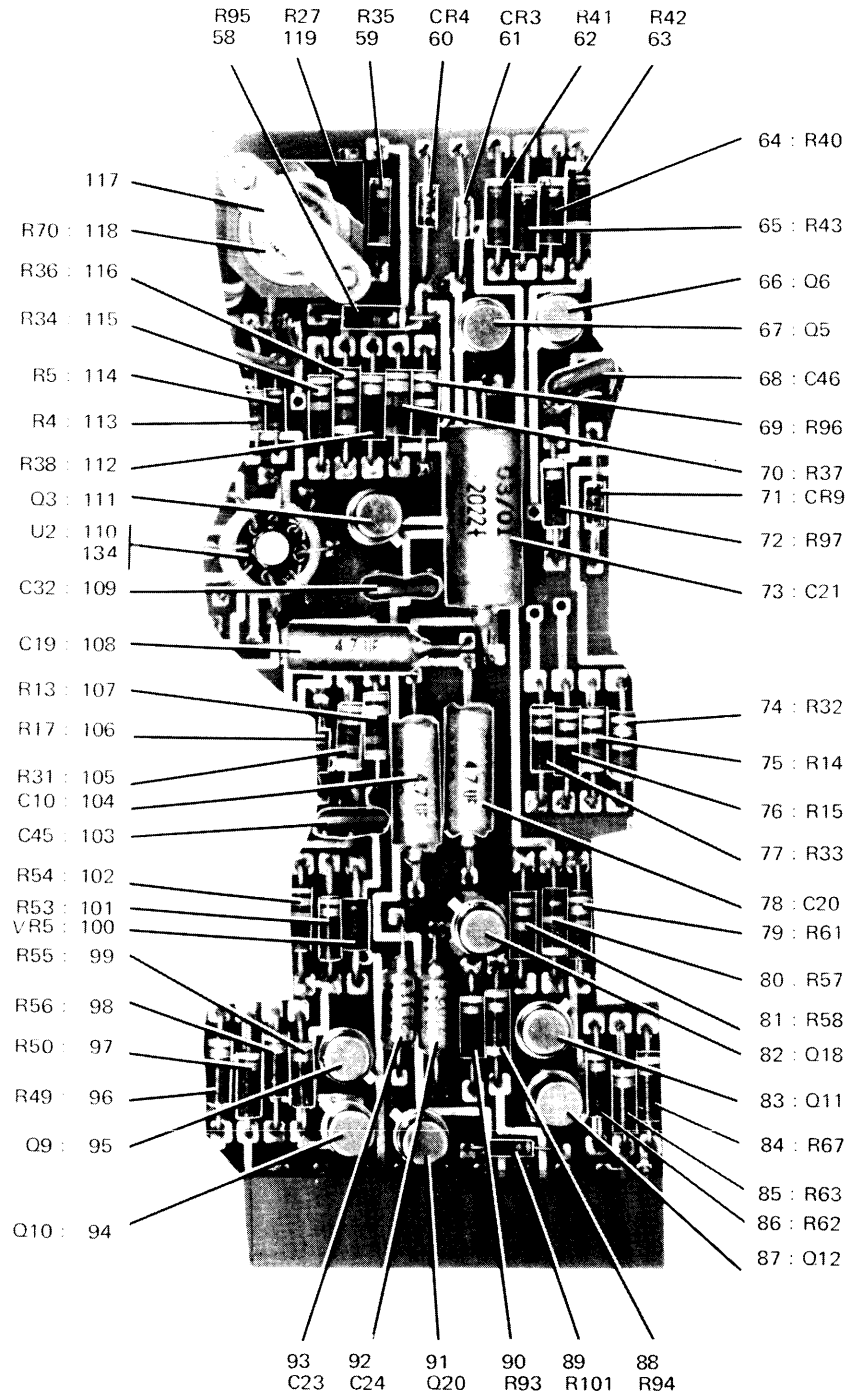

DETAIL B

TP3-1040-047

Audio Amplifier Circuit Card Assembly (A2) 778-2948-002, -004  
Figure 25 (Sheet 3 of 4)

GROUP ASSEMBLY PARTS LIST

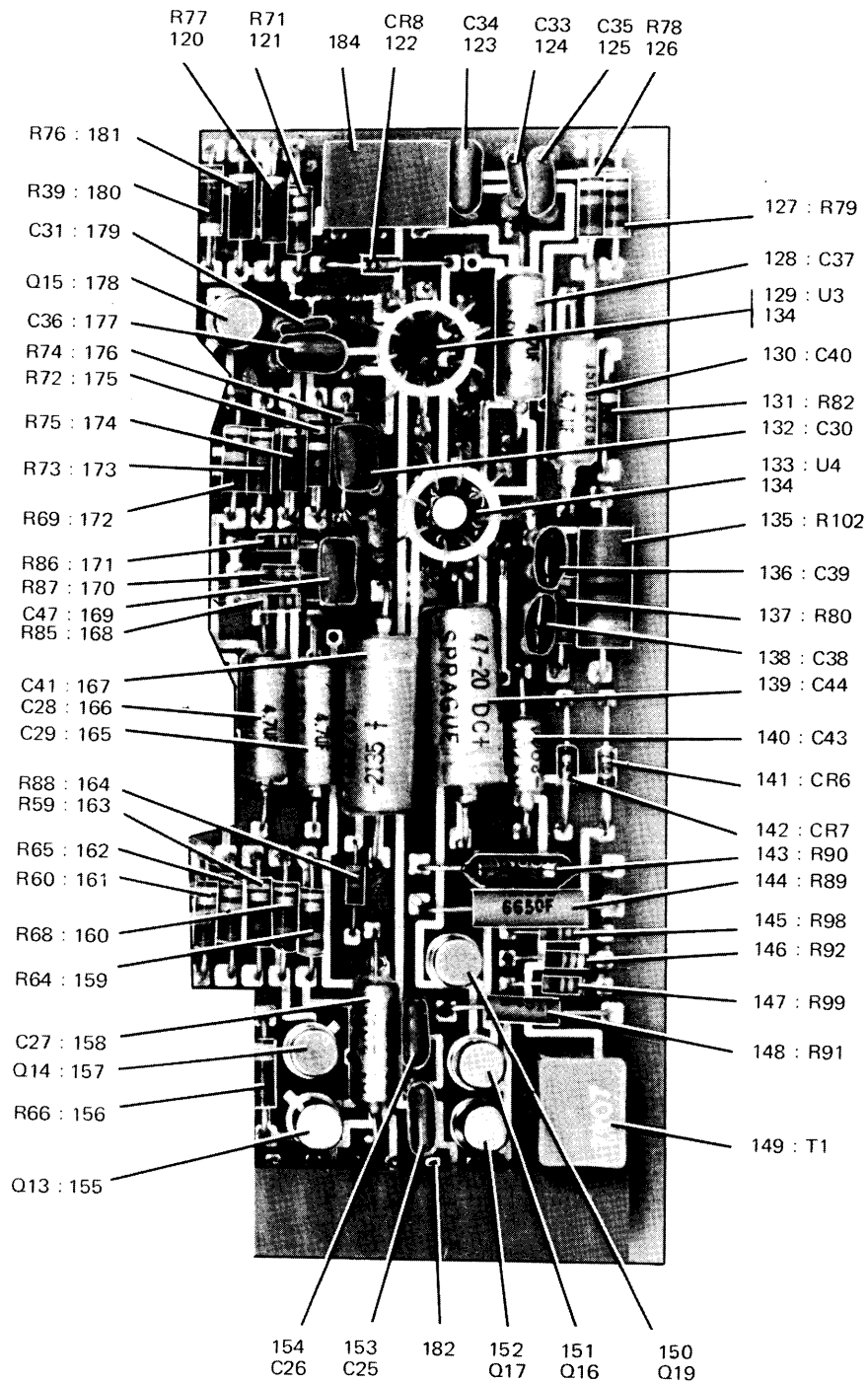

DETAIL C

TP3-1040-047

Audio Amplifier Circuit Card Assembly (A2) 778-2948-002, -004  
Figure 25 (Sheet 4 of 4)

## GROUP ASSEMBLY PARTS LIST

FIG - ITEM	PART NO	INDENT	DESCRIPTION	USABLE ON CODE	UNITS PER ASSY
25	5 RCR07G563KS	2	RESISTOR,FXD, CMPSN, 56K, 10%, 1/4W (V81349) 745-0812-000 A2R8		1
	6 MC1435G	2	INTEGRATED CKT, (V04713) 351-1034-020 A2U1		1
	7 RCR07G332KS	2	RESISTOR,FXD, CMPSN, 3.3K, 10%, 1/4W (V81349) 745-0767-000 A2R24		1
	8 2C067103X0101A3	2	CAPACITOR,FXD, CER DIEI, 0.01UF, 20%, 100V (V56289) 913-4240-100 A2C18		1
	9 2C067103X0101A3	2	CAPACITOR,FXD, CER DIEI, 0.01UF, 20%, 100V (V56289) 913-4240-100 A2C12		1
	10 2N2907A	2	TRANSISTOR, (V07688) 352-0551-010 A2Q4		1
	11 RCR07G273KS	2	RESISTOR,FXD, CMPSN, 27K, 10%, 1/4W (V81349) 745-0800-000 A2R7		1
	12 RCR07G133JS	2	RESISTOR,FXD, CMPSN, 13K, 5%, 1/4W (V81349) 745-0789-000 A2R9		1
	13 RCR07G511JS	2	RESISTOR,FXD, CMPSN, 510 OHMS, 5%, 1/4W (V81349) 745-0738-000 A2R10		1
	14 RCR07G273KS	2	RESISTOR,FXD, CMPSN, 27K, 10%, 1/4W (V81349) 745-0800-000 A2R6		1
	15 1N914	2	SEMICONV DEVICE, (V07688) 353-2906-000 A2CR2		1
	16 2C067223X0101A3	2	CAPACITOR,FXD, CER DIEI, 0.022UF, 20%, 100V (V56289) 913-4240-090 A2C7		1
	17 RCR07G513JS	2	RESISTOR,FXD, CMPSN, 51K, 5%, 1/4W (V81349) 745-0810-000 A2R19		1
	18 RCR07G222KS	2	RESISTOR,FXD, CMPSN, 2.2K, 10%, 1/4W (V81349) 745-0761-000 A2R100		1
	19 150D475X0035B2	2	CAPACITOR,FXD, ELCTLT, 4.7UF, 20%, 35V (V56289) 184-7396-000 A2C9		1
	20 T055-31-6K1F	2	RESISTOR,FXD, FILM, 31.6K, 1%, 1/8W (V11502) 705-1454-750 A2R11		1
	21 2N2222A	2	TRANSISTOR, (V07688) 352-0661-020 A2Q1		1
	22 2N2222A	2	TRANSISTOR, (V07688) 352-0661-020 A2Q2		1
	23 RCR07G123KS	2	RESISTOR,FXD, CMPSN, 12K, 10%, 1/4W (V81349) 745-0788-000 A2R44		1
	24 RCR07G913JS	2	RESISTOR,FXD, CMPSN, 91K, 5%, 1/4W (V81349) 745-0819-000 A2R84		1
	25 RCR07G913JS	2	RESISTOR,FXD, CMPSN, 91K, 5%, 1/4W (V81349) 745-0819-000 A2R51		1
	26 RCR07G123KS	2	RESISTOR,FXD, CMPSN, 12K, 10%, 1/4W (V81349) 745-0788-000 A2R52		1
	27 RCR07G102KS	2	RESISTOR,FXD, CMPSN, 1K, 10%, 1/4W (V81349) 745-0749-000 A2R45		1
	28 RCR07G103KS	2	RESISTOR,FXD, CMPSN, 10K, 10%, 1/4W (V81349) 745-0785-000 A2R48		1
	29 2N2222A	2	TRANSISTOR, (V07688) 352-0661-020 A2Q7		1
	30 M39003-01-2111	2	CAPACITOR,FXD, ELCTLT, 0.47UF, 20%, 50V (V81349) 184-9084-380 A2C22		1
	31 2N2222A	2	TRANSISTOR, (V07688) 352-0661-020 A2Q8		1
	32 8131-050-651-104 M	2	CAPACITOR,FXD, CER DIEI, 0.1UF, 20%, 50V (V72982) 913-3279-200 A2C2		1
	33 2C067103X0101A3	2	CAPACITOR,FXD, CER DIEI, 0.01UF, 20%, 100V (V56289) 913-4240-100 A2C1		1
	34 1N4733	2	SEMICONV DEVICE, (V07688) 353-6481-120 A2VR1		1
	35 T055-5-11K1F	2	RESISTOR,FXD, FILM, 5.11K, 1%, 1/8W (V11502) 705-1454-560 A2R29		1
	36 RW69V151	2	RESISTOR,FXD,HW, 150 OHMS, 5%, 3W (V81349) 747-5385-000 A2R1		1
	37 150D476X0020R2	2	CAPACITOR,FXD, ELCTLT, 47UF, 20%, 20V (V56289) 184-7664-000 A2C4		1
	38 RCR07G511JS	2	RESISTOR,FXD, CMPSN, 510 OHMS, 5%, 1/4W (V81349) 745-0738-000 A2R83		1
	39 RN55D5761F	2	RESISTOR,FXD, FILM, 5.76K, 1%, 1/8W (V81349) 705-3605-360 A2R12		1

## GROUP ASSEMBLY PARTS LIST

FIG - ITEM	PART NO	INDENT	DESCRIPTION	USABLE ON CODE	UNITS PER ASSY
25	40	RCR07G511JS	2 RESISTOR,FXD, CMPSN, 510 OHMS, 5%, 1/4W (V81349) 745-0738-000 A2R26		1
41	263C025681X5101B	2	CAPACITOR,FXD, CER DIEI, 680PF, 5%, 100V (V56289) 913-4490-300 A2C17		1
42	RCR07G563KS	2	RESISTOR,FXD, CMPSN, 56K, 10%, 1/4W (V81349) 745-0812-000 A2R25		1
43	RCR07G154KS	2	RESISTOR,FXD, CMPSN, 0.15MEGO, 10%, 1/4W (V81349) 745-0827-000 A2R23		1
44	RCR07G103KS	2	RESISTOR,FXD, CMPSN, 10K, 10%, 1/4W (V81349) 745-0785-000 A2R20		1
45	RCR07G151KS	2	RESISTOR,FXD, CMPSN, 150 OHMS, 10%, 1/4W (V81349) 745-0719-000 A2R18		1
46	RCR07G511JS	2	RESISTOR,FXD, CMPSN, 510 OHMS, 5%, 1/4W (V81349) 745-0738-000 A2R16		1
47	2C067103X0101A3	2	CAPACITOR,FXD, CER DIEI, 0.01UF, 20%, 100V (V56289) 913-4240-100 A2C14		1
48	RCR07G154KS	2	RESISTOR,FXD, CMPSN, 0.15MEGO, 10%, 1/4W (V81349) 745-0827-000 A2R22		1
49	T055-31-6K1F	2	RESISTOR,FXD, FILM, 31.6K, 1%, 1/8W (V11502) 705-1454-750 A2R28		1
50	RCR07G753JS	2	RESISTOR,FXD, CMPSN, 75K, 5%, 1/4W (V81349) 745-0816-000 A2R21		1
51	2C067103X0101A3	2	CAPACITOR,FXD, CER DIEI, 0.01UF, 20%, 100V (V56289) 913-4240-100 A2C8		1
52	2C067103X0101A3	2	CAPACITOR,FXD, CER DIEI, 0.01UF, 20%, 100V (V56289) 913-4240-100 A2C13		1
53	DM5F331J050WV	2	CAPACITOR,FXD, MICA DIEI, 330PF, 5%, 50V (V72136) 912-4141-490 A2C16		1
54	2C067103X0101A3	2	CAPACITOR,FXD, CER DIEI, 0.01UF, 20%, 100V (V56289) 913-4240-100 A2C6		1
55	DM5F331J050WV	2	CAPACITOR,FXD, MICA DIEI, 330PF, 5%, 50V (V72136) 912-4141-490 A2C15		1
56	RN60C5622F	2	RESISTOR,FXD, FILM, 56.2K, 1%, 1/8W (V81349) 705-6315-000 A2R30		1
57	150D475X0035B2	2	CAPACITOR,FXD, ELCTLT, 4.7UF, 20%, 35V (V56289) 184-7396-000 A2C5		1
58	RCR07G223KS	2	RESISTOR,FXD, CMPSN, 22K, 10%, 1/4W (V81349) 745-0797-000 A2R95		1
59	RCR07G473KS	2	RESISTOR,FXD, CMPSN, 47K, 10%, 1/4W (V81349) 745-0809-000 A2R35		1
60	1N914	2	SEMICOND DEVICE, (V07688) 353-2906-000 A2CR4		1
61	1N914	2	SEMICOND DEVICE, (V07688) 353-2906-000 A2CR3		1
62	RCR07G682KS	2	RESISTOR,FXD, CMPSN, 6.8K, 10%, 1/4W (V81349) 745-0779-000 A2R41		1
63	RCR07G472KS	2	RESISTOR,FXD, CMPSN, 4.7K, 10%, 1/4W (V81349) 745-0773-000 A2R42		1
64	RCR07G222KS	2	RESISTOR,FXD, CMPSN, 2.2K, 10%, 1/4W (V81349) 745-0761-000 A2R40		1
65	RCR07G222KS	2	RESISTOR,FXD, CMPSN, 2.2K, 10%, 1/4W (V81349) 745-0761-000 A2R43		1
66	2N2222A	2	TRANSISTOR, (V07688) 352-0661-020 A2Q6		1
67	2N2222A	2	TRANSISTOR, (V07688) 352-0661-020 A2Q5		1
68	8131-100C0G332K	2	CAPACITOR,FXD, CER DIEI, 3300PF, 10%, 100V (V18796) 913-3281-170 A2C46		1
69	RCR07G104KS	2	RESISTOR,FXD, CMPSN, 0.10MEGO, 10%, 1/4W (V81349) 745-0821-000 A2R96		1
70	RCR07G101KS	2	RESISTOR,FXD, CMPSN, 100 OHMS, 10%, 1/4W (V81349) 745-0713-000 A2R37		1
71	1N914	2	SEMICOND DEVICE, (V07688) 353-2906-000 A2CR9		1
72	RCR07G105KS	2	RESISTOR,FXD, CMPSN, 1MEGO, 10%, 1/4W (V81349) 745-0857-000 A2R97		1
73	M39003-01-2022	2	CAPACITOR,FXD, ELCTLT, 100UF, 20%, 10V (V81349) 184-9083-220 A2C21		1

## GROUP ASSEMBLY PARTS LIST

FIG - ITEM	PART NO	INDENT	DESCRIPTION	USABLE ON CODE	UNITS PER ASSY
25	74	RCR07G474KS	2 RESISTOR,FXD, CMPSN, 0.47MEGO, 10%, 1/4W (V81349) 745-0845-000 A2R32		1
	75	RCR07G474KS	2 RESISTOR,FXD, CMPSN, 0.47MEGO, 10%, 1/4W (V81349) 745-0845-000 A2R14		1
	76	RCR07G104KS	2 RESISTOR,FXD, CMPSN, 0.10MEGO, 10%, 1/4W (V81349) 745-0821-000 A2R15		1
	77	RCR07G104KS	2 RESISTOR,FXD, CMPSN, 0.10MEGO, 10%, 1/4W (V81349) 745-0821-000 A2R33		1
	78	150D475X0035B2	2 CAPACITOR,FXD, ELCTLT, 4.7UF, 20%, 35V (V56289) 184-7396-000 A2C20		1
	79	RCR07G103KS	2 RESISTOR,FXD, CMPSN, 10K, 10%, 1/4W (V81349) 745-0785-000 A2R61		1
	80	RCR07G913JS	2 RESISTOR,FXD, CMPSN, 91K, 5%, 1/4W (V81349) 745-0819-000 A2R57		1
	81	RCR07G123KS	2 RESISTOR,FXD, CMPSN, 12K, 10%, 1/4W (V81349) 745-0788-000 A2R58		1
	82	2N2222A	2 TRANSISTOR, (V07688) 352-0661-020 A2Q18		1
	83	2N2222A	2 TRANSISTOR, (V07688) 352-0661-020 A2Q11		1
	84	RCR07G222KS	2 RESISTOR,FXD, CMPSN, 2.2K, 10%, 1/4W (V81349) 745-0761-000 A2R67		1
	85	RCR07G222KS	2 RESISTOR,FXD, CMPSN, 2.2K, 10%, 1/4W (V81349) 745-0761-000 A2R63		1
	86	RCR07G222KS	2 RESISTOR,FXD, CMPSN, 2.2K, 10%, 1/4W (V81349) 745-0761-000 A2R62		1
	87	2N2222A	2 TRANSISTOR, (V07688) 352-0661-020 A2Q12		1
	88	RCR07G472KS	2 RESISTOR,FXD, CMPSN, 4.7K, 10%, 1/4W (V81349) 745-0773-000 A2R94		1
	89	RCR07G222KS	2 RESISTOR,FXD, CMPSN, 2.2K, 10%, 1/4W (V81349) 745-0761-000 A2R101		1
	90	RCR07G222KS	2 RESISTOR,FXD, CMPSN, 2.2K, 10%, 1/4W (V81349) 745-0761-000 A2R93		1
	91	2N2222A	2 TRANSISTOR, (V07688) 352-0661-020 A2Q20		1
	92	M39003-01-2111	2 CAPACITOR,FXD, ELCTLT, 0.47UF, 20%, 50V (V81349) 184-9084-380 A2C24		1
	93	M39003-01-2111	2 CAPACITOR,FXD, ELCTLT, 0.47UF, 20%, 50V (V81349) 184-9084-380 A2C23		1
	94	2N2222A	2 TRANSISTOR, (V07688) 352-0661-020 A2Q10		1
	95	2N2222A	2 TRANSISTOR, (V07688) 352-0661-020 A2Q9		1
	96	RCR07G222KS	2 RESISTOR,FXD, CMPSN, 2.2K, 10%, 1/4W (V81349) 745-0761-000 A2R49		1
	97	RCR07G222KS	2 RESISTOR,FXD, CMPSN, 2.2K, 10%, 1/4W (V81349) 745-0761-000 A2R50		1
	98	RCR07G222KS	2 RESISTOR,FXD, CMPSN, 2.2K, 10%, 1/4W (V81349) 745-0761-000 A2R56		1
	99	RCR07G222KS	2 RESISTOR,FXD, CMPSN, 2.2K, 10%, 1/4W (V81349) 745-0761-000 A2R55		1
	100	1N4741	2 SEMICOND DEVICE, (V07688) 353-6481-280 A2VR5		1
	101	RCR07G102KS	2 RESISTOR,FXD, CMPSN, 1K, 10%, 1/4W (V81349) 745-0749-000 A2R53		1
	102	RCR07G103KS	2 RESISTOR,FXD, CMPSN, 10K, 10%, 1/4W (V81349) 745-0785-000 A2R54		1
	103	2C067473X0101A3	2 CAPACITOR,FXD, CER DIEI, 0.047UF, 20%, 100V (V56289) 913-4240-080 A2C45		1
	104	150D475X0035B2	2 CAPACITOR,FXD, ELCTLT, 4.7UF, 20%, 35V (V56289) 184-7396-000 A2C10		1
	105	RCR07G472KS	2 RESISTOR,FXD, CMPSN, 4.7K, 10%, 1/4W (V81349) 745-0773-000 A2R31		1
	106	RCR07G151KS	2 RESISTOR,FXD, CMPSN, 150 OHMS, 10%, 1/4W (V81349) 745-0719-000 A2R17		1
	107	RCR07G472KS	2 RESISTOR,FXD, CMPSN, 4.7K, 10%, 1/4W (V81349) 745-0773-000 A2R13		1
	108	150D475X0035B2	2 CAPACITOR,FXD, ELCTLT, 4.7UF, 20%, 35V (V56289) 184-7396-000 A2C19		1

GROUP ASSEMBLY PARTS LIST

FIG - ITEM	PART NO	INDENT	DESCRIPTION	USABLE ON CODE	UNITS PER ASSY
25 109	2C067473X0101A3	2	CAPACITOR,FXD, CER DIEL, 0.047UF, 20%, 100V (V56289) 913-4240-080 A2C32		1
110	RC741T	2	INTEGRATED CKT, (V49956) 351-1029-020 A2U2		1
111	2N2907A	2	TRANSISTOR, (V07688) 352-0551-010 A2Q3		1
112	RCR07G102KS	2	RESISTOR,FXD, CMPSN, 1K, 10%, 1/4W (V81349) 745-0749-000 A2R38		1
113	RCR07G682KS	2	RESISTOR,FXD, CMPSN, 6.8K, 10%, 1/4W (V81349) 745-0779-000 A2R4		1
114	RCR07G102KS	2	RESISTOR,FXD, CMPSN, 1K, 10%, 1/4W (V81349) 745-0749-000 A2R5		1
115	RCR07G103KS	2	RESISTOR,FXD, CMPSN, 10K, 10%, 1/4W (V81349) 745-0785-000 A2R34		1
116	RCR07G473KS	2	RESISTOR,FXD, CMPSN, 47K, 10%, 1/4W (V81349) 745-0809-000 A2R36		1
117	756-7045-002 MS51957-8	2	STRAP, MOUNTING		1
		2	SCREW,MACH, SST, 2-56 X 5/8 (V96906) 343-0005-000 (AP)		2
118	RT22C2L502	2	RESISTOR,VAR,WW, 5K, 5%, 3/4W (V81349) 381-1721-120 A2R70		1
119	RT22C2L103	2	RESISTOR,VAR, WW, 10K, 5%, 3/4W (V81349) 381-1721-140 A2R27		1
120	RCR07G202JS	2	RESISTOR,FXD, CMPSN, 2K, 5%, 1/4W (V81349) 745-0759-000 A2R77		1
121	RCR07G103KS	2	RESISTOR,FXD, CMPSN, 10K, 10%, 1/4W (V81349) 745-0785-000 A2R71		1
122	1N914	2	SEMICOND DEVICE, (V07688) 353-2906-000 A2CR8		1
123	2C067472X0101A3	2	CAPACITOR,FXD, CER DIEL, 0.0047UF, 20%, 100V (V56289) 913-4240-110 A2C34		1
124	K05SK102M	2	CAPACITOR,FXD, CER DIEL, 1000PF, 10%, 100V (V05397) 913-4489-360 A2C33		1
125	2C067103X0101A3	2	CAPACITOR,FXD, CER DIEL, 0.01UF, 20%, 100V (V56289) 913-4240-100 A2C35		1
126	RCR07G151KS	2	RESISTOR,FXD, CMPSN, 150 OHMS, 10%, 1/4W (V81349) 745-0719-000 A2R78		1
127	RCR07G681JS	2	RESISTOR,FXD, CMPSN, 680 OHMS, 5%, 1/4W (V81349) 745-0742-000 A2R79		1
128	150D475X0035B2	2	CAPACITOR,FXD, ELCTLT, 4.7UF, 20%, 35V (V56289) 184-7396-000 A2C37		1
129	MC1435G	2	INTEGRATED CKT, (V04713) 351-1034-020 A2U3		1
130	150D475X0035B2	2	CAPACITOR,FXD, ELCTLT, 4.7UF, 20%, 35V (V56289) 184-7396-000 A2C40		1
131	RCR07G182KS	2	RESISTOR,FXD, CMPSN, 1.8K, 10%, 1/4W (V81349) 745-0758-000 A2R82		1
132	2C067103X0101A3	2	CAPACITOR,FXD, CER DIEL, 0.01UF, 20%, 100V (V56289) 913-4240-100 A2C30		1
133	U5B7716393	2	INTEGRATED CKT, (V07263) 351-1008-010 A2U4		1
134	7717-114N	2	INSULATOR,DISK, (V13103) 352-9552-550	BQ	4
134	7717-114N	2	INSULATOR,DISK, (V13103) 352-9552-550 (EFF TO CI 72446)	BR	4
135	MS90539-15	2	COIL,RF, 1000UH (V96906) 240-2540-000 A2L1 (EFF TO CI 72373)	BQ	1
135	RCR07G101KS	2	RESISTOR,FXD, CMPSN, 100 OHMS, 10%, 1/4W (V81349) 745-0713-000 A2R102 (EFF CI 72373)	BQ	1
135	RCR07G101KS	2	RESISTOR,FXD, CMPSN, 100 OHMS, 10%, 1/4W (V81349) 745-0713-000 A2R102	BR	1
136	DM5E430J050WV	2	CAPACITOR,FXD, MICA DIEL, 43PF, 5%, 50V (V72136) 912-4141-260 A2C39		1
137	RCR07G750JS	2	RESISTOR,FXD, CMPSN, 75 OHMS, 5%, 1/4W (V81349) 745-0708-000 A2R80		1
138	DM5E680J050WV	2	CAPACITOR,FXD, MICA DIEL, 68PF, 5%, 50V (V72136) 912-4141-330 A2C38		1
139	150D476X0020R2	2	CAPACITOR,FXD, ELCTLT, 47UF, 20%, 20V (V56289) 184-7664-000 A2C44		1

## GROUP ASSEMBLY PARTS LIST

FIG - ITEM	PART NO	INDENT	DESCRIPTION	USABLE ON CODE	UNITS PER ASSY
25 140	M39003-01-2044	2	CAPACITOR,FXD, ELCTLT, 2.2UF, 20%, 20V (V81349) 184-9083-440 A2C43		1
141	1N914	2	SEMICONV DEVICE, (V07688) 353-2906-000 A2CR6		1
142	1N914	2	SEMICONV DEVICE, (V07688) 353-2906-000 A2CR7		1
143	RN60D6040F	2	RESISTOR,FXD, FILM, 604 OHMS, 1%, 1/4W (V81349) 705-3603-700 A2R90		1
144	RN60D6650F	2	RESISTOR,FXD, FILM, 665 OHMS, 1%, 1/4W (V81349) 705-3603-710 A2R89		1
145	RCR07G103KS	2	RESISTOR,FXD, CMPSN, 10K, 10%, 1/4W (V81349) 745-0785-000 A2R98		1
146	RCR07G223KS	2	RESISTOR,FXD, CMPSN, 22K, 10%, 1/4W (V81349) 745-0797-000 A2R92		1
147	RCR07G103KS	2	RESISTOR,FXD, CMPSN, 10K, 10%, 1/4W (V81349) 745-0785-000 A2R99		1
148	T055-9-09K1F	2	RESISTOR,FXD, FILM, 9.09K, 1%, 1/8W (V11502) 705-1454-620 A2R91		1
149	SP67	2	TRANSFORMER,AF, (V81095) 677-1684-000 A2T1		1
150	2N2222A	2	TRANSISTOR, (V07688) 352-0661-020 A2Q19		1
151	2N2222A	2	TRANSISTOR, (V07688) 352-0661-020 A2Q16		1
152	2N2222A	2	TRANSISTOR, (V07688) 352-0661-020 A2Q17		1
153	2C067472X0101A3	2	CAPACITOR,FXD, CER DIEI, 0.0047UF, 20%, 100V (V56289) 913-4240-110 A2C25		1
154	2C067103X0101A3	2	CAPACITOR,FXD, CER DIEI, 0.01UF, 20%, 100V (V56289) 913-4240-100 A2C26		1
155	2N2222A	2	TRANSISTOR, (V07688) 352-0661-020 A2Q13		1
156	RCR07G222KS	2	RESISTOR,FXD, CMPSN, 2.2K, 10%, 1/4W (V81349) 745-0761-000 A2R86		1
157	2N2222A	2	TRANSISTOR, (V07688) 352-0661-020 A2Q14		1
158	M39003-01-2065	2	CAPACITOR,FXD, ELCTLT, 6.8UF, 20%, 35V (V81349) 184-9083-650 A2C27		1
159	RCR07G332KS	2	RESISTOR,FXD, CMPSN, 3.3K, 10%, 1/4W (V81349) 745-0767-000 A2R64		1
160	RCR07G562KS	2	RESISTOR,FXD, CMPSN, 5.6K, 10%, 1/4W (V81349) 745-0776-000 A2R68		1
161	RCR07G102KS	2	RESISTOR,FXD, CMPSN, 1K, 10%, 1/4W (V81349) 745-0749-000 A2R60		1
162	RCR07G103KS	2	RESISTOR,FXD, CMPSN, 10K, 10%, 1/4W (V81349) 745-0785-000 A2R65		1
163	RCR07G682KS	2	RESISTOR,FXD, CMPSN, 6.8K, 10%, 1/4W (V81349) 745-0779-000 A2R59		1
164	RCR07G153KS	2	RESISTOR,FXD, CMPSN, 15K, 10%, 1/4W (V81349) 745-0791-000 A2R88		1
165	150D475X0035B2	2	CAPACITOR,FXD, ELCTLT, 4.7UF, 20%, 35V (V56289) 184-7396-000 A2C29		1
166	150D475X0035B2	2	CAPACITOR,FXD, ELCTLT, 4.7UF, 20%, 35V (V56289) 184-7396-000 A2C28		1
167	M39003-01-2135	2	CAPACITOR,FXD, ELCTLT, 10UF, 20%, 50V (V81349) 184-9084-620 A2C41		1
168	RCR07G473KS	2	RESISTOR,FXD, CMPSN, 47K, 10%, 1/4W (V81349) 745-0809-000 A2R85		1
169	2C067103X0101A3	2	CAPACITOR,FXD, CER DIEI, 0.01UF, 20%, 100V (V56289) 913-4240-100 A2C47		1
170	RCR07G103KS	2	RESISTOR,FXD, CMPSN, 10K, 10%, 1/4W (V81349) 745-0785-000 A2R87		1
171	RCR07G124KS	2	RESISTOR,FXD, CMPSN, 0.12MEGO, 10%, 1/4W (V81349) 745-0824-000 A2R86		1
172	RCR07G103KS	2	RESISTOR,FXD, CMPSN, 10K, 10%, 1/4W (V81349) 745-0785-000 A2R69		1
173	RCR07G151KS	2	RESISTOR,FXD, CMPSN, 150 OHMS, 10%, 1/4W (V81349) 745-0719-000 A2R73		1
174	RCR07G202JS	2	RESISTOR,FXD, CMPSN, 2K, 5%, 1/4W (V81349) 745-0759-000 A2R75		1

GROUP ASSEMBLY PARTS LIST

FIG - ITEM	PART NO	INDENT	DESCRIPTION	USABLE ON CODE	UNITS PER ASSY
25 175	RCR07G274KS	2	RESISTOR,FXD, CMPSN, 0.27MEGO, 10%, 1/4W (V81349) 745-0836-000 A2R72		1
176	RCR07G682KS	2	RESISTOR,FXD, CMPSN, 6.8K, 10%, 1/4W (V81349) 745-0779-000 A2R74		1
177	8131-050-651-104 M	2	CAPACITOR,FXD, CER DIEI, 0.1UF, 20%, 50V (V72982) 913-3279-200 A2C36		1
178	2N2608	2	TRANSISTOR, (V07688) 352-0605-010 A2015		1
179	K05SK102M	2	CAPACITOR,FXD, CER DIEI, 1000PF, 10%, 100V (V05397) 913-4489-360 A2C31		1
180	RCR07G472KS	2	RESISTOR,FXD, CMPSN, 4.7K, 10%, 1/4W (V81349) 745-0773-000 A2R39		1
181	RCR07G202JS	2	RESISTOR,FXD, CMPSN, 2K, 5%, 1/4W (V81349) 745-0759-000 A2R76		1
182	372-2234-010	2	CONTACT,ELEC, (V13499) 372-2234-010		21
183	372-2234-020	2	CONTACT,ELEC, (V13499) 372-2234-020		24
184	372-2623-012	2	HOUSING,CONN,EL, 372-2623-012		1
185	372-2623-037	2	HOUSING,CONN,EL, 372-2623-037		1
186	790-2768-001	2	HANDLE	RQ	1
186	790-2768-004	2	HANDLE	BR	1
	MS51923-314	2	PIN,SPRING, SST, 0.078 DIA X 1/4 (V96906) 311-0465-000 (AP)		1
26 -	606-9423-003	1	CHASSIS ASSY, RECEIVER (SEE FIG 1-40 FOR NHA)	BS	RF
-	606-9423-005	1	CHASSIS ASSY, RECEIVER (SEE FIG 1-40 FOR NHA)	BT	RF
-	606-9423-006	1	CHASSIS ASSY, RECEIVER (SEE FIG 1-40 FOR NHA)	BU	RF
-	606-9423-007	1	CHASSIS ASSY, RECEIVER (SEE FIG 1-40 FOR NHA)	BV	RF
-	606-9423-009	1	CHASSIS ASSY, RECEIVER (SEE FIG 1-40 FOR NHA)	BW	RF
1	609-1609-001	2	BAR, REINFORCING		1
	P343-0290-000	2	SCREW,MACH, NP BRS, 4-40 X 5/8 (V77250) 343-0290-000 (AP)		2
	310-0278-000	2	WASHER,LOCK, SST, 0.115 ID X 0.202 OD (V70318) 310-0278-000 (AP)		2
	310-0054-000	2	WASHER,FLAT, BRS, 0.125 ID X 0.312 OD (V79807) 310-0054-000 (AP)		2
2	HP10N	2	CLAMP,LOOP, (V09922) 150-1546-000		1
3	HP8N	2	CLAMP,LOOP, (V09922) 150-1545-000		1
	P343-0286-000	2	SCREW,MACH, NP BRS, 4-40 X 5/16 (V77250) 343-0286-000 (AP FOR 2,3)		2
	310-0054-000	2	WASHER,FLAT, BRS, 0.125 ID X 0.312 OD (V79807) 310-0054-000 (AP FOR 2,3)		2
4	RCR20G471KS	2	RESISTOR,FXD, CMPSN, 470 OHMS, 10%, 1/2W (V81349) 745-1338-000 R205		1
5	RCR20G222KS	2	RESISTOR,FXD, CMPSN, 2.2K, 10%, 1/2W (V81349) 745-1366-000 R203		1
6	4021	2	TERMINAL,LUG, (V77147) 304-8000-000		8
	P343-0345-000	2	SCREW,MACH, NP BRS, 10-32 X 3/8 (V77250) 343-0345-000 (AP)		2
	P343-0343-000	2	SCREW,MACH, NP BRS, 10-32 X 1/4 (V77250) 343-0343-000 (AP)		2
	MS35333-73	2	WASHER,LOCK, SST, 0.204 ID X 0.381 OD (V96906) 373-0043-000 (AP)		4
7	36D303G015CC2A	2	CAPACITOR,FXD, ELCTLT, 3000UF, M10XP100X, 15V (V56289) 183-1278-050 C205		1
8	36D902G050BC2A	2	CAPACITOR,FXD, ELCTLT, 9000UF, M10XP100X, 50V (V56289) 183-1278-380 C207		1
	MS51957-31	2	SCREW,MACH, SST, 6-32 X 5/8 (V96906) 343-0173-000 (AP FOR 7,8)		2
9	10-70506-16	2	CAP,ELECTRICAL, (V77820) 357-8662-000		2
10	10-70506-18	2	CAP,ELECTRICAL, (V77820) 357-8663-000		1
11	14464	2	MOUNTING RINGS, (V14655) 139-0137-000		1





GROUP ASSEMBLY PARTS LIST

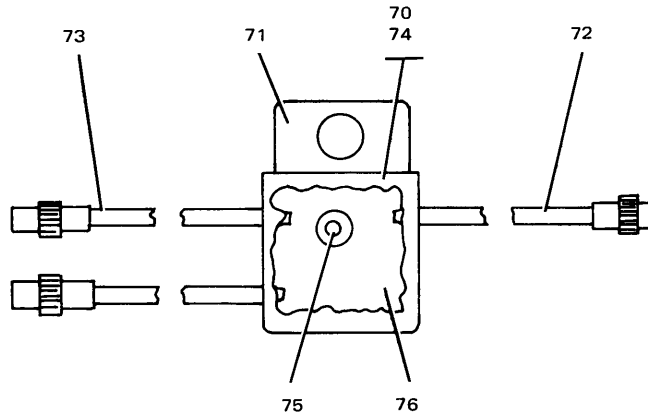

DETAIL A

TP3-2265-019

Receiver Chassis Assembly 606-9423-003, -005, -006, -007, -009  
Figure 26 (Sheet 2 of 2)

FIG - ITEM	PART NO	INDENT	DESCRIPTION	USABLE ON CODE	UNITS PER ASSY
26 12	13590	2	MOUNTING RINGS, (V14655) 139-0138-000		1
	MS35649-284	2	NUT, PLAIN, HEX, SST, 8-32 (V96906) 313-0017-000 (AP FOR 11,12)		4
	MS35338-137	2	WASHER, LOCK, SST, 0.168 ID X 0.296 OD (V96906) 310-0072-000 (AP FOR 11,12)		4
	4021	2	TERMINAL, LUG, (V77147) 304-8000-000 (AP FOR 11)		1
	310-6380-000	2	WASHER, FLAT, SST, 0.187 ID X 0.375 OD (V79807) 310-6380-000 (AP FOR 11,12)		4
	MS51957-43	2	SCREW, MACH, SST, 6-32 X 1-1/4 (V96906) 343-0187-000 (AP FOR 11,12)		3
	MS51957-44	2	SCREW, MACH, SST, 8-32 X 7/16 (V96906) 343-0188-000 (AP FOR 11)		1
13	606-9425-003	2	PANEL, ASSY, FRONT (SEE FIG 39)	BS, BU	1
13	606-9425-004	2	PANEL, ASSY, FRONT (SEE FIG 39)	BT	1
13	606-9425-005	2	PANEL, ASSY, FRONT (SEE FIG 39)	BV, BW	1
14	606-9424-002	2	POWER SUPPLY, RECEIVER, RADIO (SEE FIG 40)	BS, BT	1
14	606-9424-004	2	POWER SUPPLY, RECEIVER, RADIO (SEE FIG 40)	BU	1
14	606-9424-005	2	POWER SUPPLY, RECEIVER, RADIO (SEE FIG 40)	BV	1
14	606-9424-006	2	POWER SUPPLY, RECEIVER, RADIO (SEE FIG 40)	BW	1
15	606-9426-002	2	CHASSIS, CENTER		1
16	606-9708-001	3	AMPLIFIER, AUDIO (EFF TO CI 72343) (SEE FIG 29)		1
16	618-7105-001	3	COMPONENT ASSY, ELECTRONIC (EFF CI 72343) (SEE FIG 30)		1
	68-1660-40	3	NUT, SLFLKG, HEX, AL, 4-40 (V72962) 333-0605-000 (AP) (EFF TO CI 72343)		2

## GROUP ASSEMBLY PARTS LIST

FIG - ITEM	PART NO	INDENT	DESCRIPTION	USABLE ON CODE	UNITS PER ASSY
26	MS51957-13	3	SCREW, MACH, STL, 4-40 X 1/4 (V96906)		2
			343-0133-000 (AP) (EFF TO CI 72343)		
	MS51957-14	3	SCREW, MACH, STL, 4-40 X 5/16 (V96906)		2
			343-0134-000 (AP) (EFF CI 72343)		
17	M39003-01-2015	3	CAPACITOR, FXD, ELCTLT, 4.7UF, 20%, 10V (V81349)		1
			184-9083-150 C405		
18	M39003-01-2026	3	CAPACITOR, FXD, ELCTLT, 220UF, 20%, 10V (V81349)		1
			184-9083-260 C406		
19	TC140	3	BRACKET, MTG, (V59730) 150-0722-010		3
	P343-0285-000	3	SCREW, MACH, NP BRS, 4-40 X 1/4 (V77250)		3
			343-0285-000 (AP)		
20	5133-18C	3	RING, RTNG, (V79136) 340-0253-000		41
			(EFF TO CI 72166)		
20	618-6623-001	3	RETAINER, (EFF CI 72166)		41
21	609-0792-001	3	RECEPTACLE, J50		1
22	609-0792-001	3	RECEPTACLE, J48		1
23	609-0792-001	3	RECEPTACLE, J43		1
24	609-0792-001	3	RECEPTACLE, J40		1
25	609-0792-001	3	RECEPTACLE, J28		1
26	609-0792-001	3	RECEPTACLE, J25		1
27	609-0792-001	3	RECEPTACLE, J16		1
28	609-0792-001	3	RECEPTACLE, J24		1
29	609-0792-001	3	RECEPTACLE, J6		1
30	609-0792-001	3	RECEPTACLE, J15		1
31	609-0792-001	3	RECEPTACLE, J18		1
32	609-0792-001	3	RECEPTACLE, J3		1
33	609-0792-001	3	RECEPTACLE, J11		1
34	609-0792-001	3	RECEPTACLE, J22		1
35	609-0792-001	3	RECEPTACLE, J12		1
36	609-0792-001	3	RECEPTACLE, J4		1
37	609-0792-001	3	RECEPTACLE, J8		1
38	609-0792-001	3	RECEPTACLE, J13		1
39	609-0792-001	3	RECEPTACLE, J19		1
40	609-0792-001	3	RECEPTACLE, J20		1
41	609-0792-001	3	RECEPTACLE, J21		1
42	609-0792-001	3	RECEPTACLE, J5		1
43	609-0792-001	3	RECEPTACLE, J7		1
44	609-0792-001	3	RECEPTACLE, J14		1
45	609-0792-001	3	RECEPTACLE, J23		1
46	609-0792-001	3	RECEPTACLE, J66		1
47	609-0792-001	3	RECEPTACLE, J29		1
48	609-0792-001	3	RECEPTACLE, J38		1
49	609-0792-001	3	RECEPTACLE, J36		1
50	609-0792-001	3	RECEPTACLE, J42		1
51	609-0792-001	3	RECEPTACLE, J41		1
52	609-0792-001	3	RECEPTACLE, J46		1
53	609-0792-001	3	RECEPTACLE, J45		1
54	609-0792-001	3	RECEPTACLE, J55		1
55	609-0792-001	3	RECEPTACLE, J51		1
56	609-0792-001	3	RECEPTACLE, J52		1
57	609-0792-001	3	RECEPTACLE, J54		1
58	609-0792-001	3	RECEPTACLE, J47		1
59	609-0792-001	3	RECEPTACLE, J35		1
60	609-0792-001	3	RECEPTACLE, J37		1
61	609-0792-001	3	RECEPTACLE, J69		1
62	140-0530-1004	3	CABLE ASSY, ELEC, (V98278) 426-5435-570		5
63	140-0530-1003	3	CABLE ASSY, ELEC, (V98278) 426-5435-560		5
64	140-0530-1007	3	CABLE ASSY, ELEC, (V98278) 426-5435-600		2
65	140-0530-1006	3	CABLE ASSY, ELEC, (V98278) 426-5435-590		1
66	140-0530-1009	3	CABLE ASSY, ELEC, (V98278) 426-5435-620		1

GROUP ASSEMBLY PARTS LIST

FIG - ITEM	PART NO	INDENT	DESCRIPTION	USABLE ON CODE	UNITS PER ASSY
26	67	140-0530-1005	3 CABLE ASSY,ELEC, (V98278) 426-5435-580		3
	68	140-0530-4019	3 CABLE ASSY,ELEC, (V98278) 426-5435-640 (EFF TO CI 72285)		2
	69	140-0530-4018	3 CABLE ASSY,FLEC, (V98278) 426-5435-630		1
	70	609-1648-001	3 CABLE ASSY, COAX		1
		P343-0285-000	3 SCREW,MACH, NP BRS, 4-40 X 1/4 (V77250)		1
			343-0285-000 (AP)		
		302-4800-000	3 WASHER,NM, FBR, 0.116 ID X 1/4 OD (V74921)		1
			302-4800-000 (AP)		
	71	609-1645-001	4 COVER		1
	72	609-1650-001	4 CABLE		2
	73	609-1649-001	4 CABLE		1
	74	609-1647-001	4 JUNCTION BOX		1
	75	SL439-433WHT	5 TERMINAL,STDF, (V12615) 306-1521-000		1
	76	609-1646-001	5 BOX		1
	77	609-9445-001	3 SHIELD		1
		MS51957-12	3 SCREW,MACH, STL, 4-40 X 3/16 (V96906)		6
			343-0132-000 (AP)		
		MS35338-135	3 WASHER,LOCK, SST, 0.115 ID X 0.209 OD (V96906)		6
			310-0279-000 (AP)		
	78	778-2950-002	3 PRINTED WIRING BOARD		1
		P343-0285-000	3 SCREW,MACH, NP BRS, 4-40 X 1/4 (V77250)		8
			343-0285-000 (AP)		
		310-0278-000	3 WASHER,LOCK, SST, 0.115 ID X 0.202 OD (V70318)		8
			310-0278-000 (AP)		
		310-0054-000	3 WASHER,FLAT, BRS, 0.125 ID X 0.312 OD (V79807)		7
			310-0054-000 (AP)		
		2104-04-01-2520N	3 TERMINAL,LUG, (V78189) 304-0317-000 (AP)		1
	79	372-2601-150	4 CONTACT,ELEC, 372-2601-150		551
	80	372-2601-010	4 CONTACT, ELEC 372-2601-010		20
	81	606-9725-001	3 CHASSIS		1
27 -	609-0928-001	1	SWITCH, POWER, KEEP-ALIVE (SEE FIG 39-22 FOR NHA)	CB,CC	RF
	1	RCR07G102KS	2 RESISTOR,FXD, CMPSN, 1K, 10%, 1/4W (V81349)		1
			745-0749-000 R506		
	2	2N1711	2 TRANSISTOR, (V07688) 352-0400-000 Q502		1
	3	RCR07G122KS	2 RESISTOR,FXD, CMPSN, 1.2K, 10%, 1/4W (V81349)		1
			745-0752-000 R507		
	4	2C067104X0101A3	2 CAPACITOR,FXD, CER DIEL, 0.1UF, 20%, 100V (V56289) 913-4240-040 C501		1
	5	RCR20G270KS	2 RESISTOR,FXD, CMPSN, 27 OHMS, 10%, 1/2W (V81349)		1
			745-1286-000 R502		
	6	RCR07G122KS	2 RESISTOR,FXD, CMPSN, 1.2K, 10%, 1/4W (V81349)		1
			745-0752-000 R501		
	7	1N4003	2 SEMICOND DEVICE, (V04713) 353-6442-030 CR502		1
	8	RCR07G180KS	2 RESISTOR,FXD, CMPSN, 18 OHMS, 10%, 1/4W (V81349)		1
			745-0686-000 R505		
	9	1N4003	2 SEMICOND DEVICE, (V04713) 353-6442-030 CR501		1
	10	M39003-01-2029	2 CAPACITOR,FXD, ELCTLT, 3.3UF, 20%, 15V (V81349)		1
			184-9083-290 C502		

GROUP ASSEMBLY PARTS LIST

FIG - ITEM	PART NO	INDENT	DESCRIPTION	USABLE ON CODE	UNITS PER ASSY
27	11	1N750A	2 SEMICOND DEVICE, (V07688) 353-2708-000 VR501		1
	12	RCR07G270KS	2 RESISTOR,FXD, CMPSN, 27 OHMS, 10%, 1/4W (V81349) 745-0692-000 R504		1
	13	RCR20G101KS	2 RESISTOR,FXD, CMPSN, 100 OHMS, 10%, 1/2W (V81349) 745-1310-000 R503		1
	14	2N2222A	2 TRANSISTOR, (V07688) 352-0661-020 Q503		1
	15	2N2907A	2 TRANSISTOR, (V07688) 352-0551-010 Q504		1
	16	T1533	2 HOLDER,XSTR, (V98291) 352-9509-000		2
	17	T1532	2 HOLDER,XSTR, (V98291) 352-9508-000		1
	18	2N3740	2 TRANSISTOR, (V07688) 352-0695-010 Q501		1
		352-9615-010	2 MOUNTING KIT, (V13103) 352-9615-010 (AP)		1
		MS35649-244	3 NUT,PLAIN,HEX, SST, 4-40 (V96906) 313-0043-000		2
		MS35338-97	3 WASHER,LOCK, BRZ, 0.115 ID X 0.212 OD (V96906) 310-0076-000		2
		4007-4HT	3 TERMINAL,LUG, (V77147) 304-0015-000		1
		310-0045-000	3 WASHER,FLAT, SST, 0.125 ID X 0.312 OD (V79807) 310-0045-000		2
		302-0646-050	3 WASHER,NM,SHLDR, PLSTC, 0.115 ID X 0.290 OD (V07896) 302-0646-050		2
		43-66-1	3 INSULATOR,PL, (V13103) 352-9605-190		1
		MS51957-15	3 SCREW,MACH, STL, 4-40 X 3/8 (V96906) 343-0135-000		2
	19	AB406D	2 TERMINAL,GND, (V12615) 306-1311-000		2
		MS35649-224	2 NUT,PLAIN,HEX, SST, 2-56 (V96906) 313-0037-000 (AP)		2
		MS35338-96	2 WASHER,SPRING, CD PL BRZ, 0.088 ID X 0.172 OD (V96906) 310-0093-000 (AP)		2

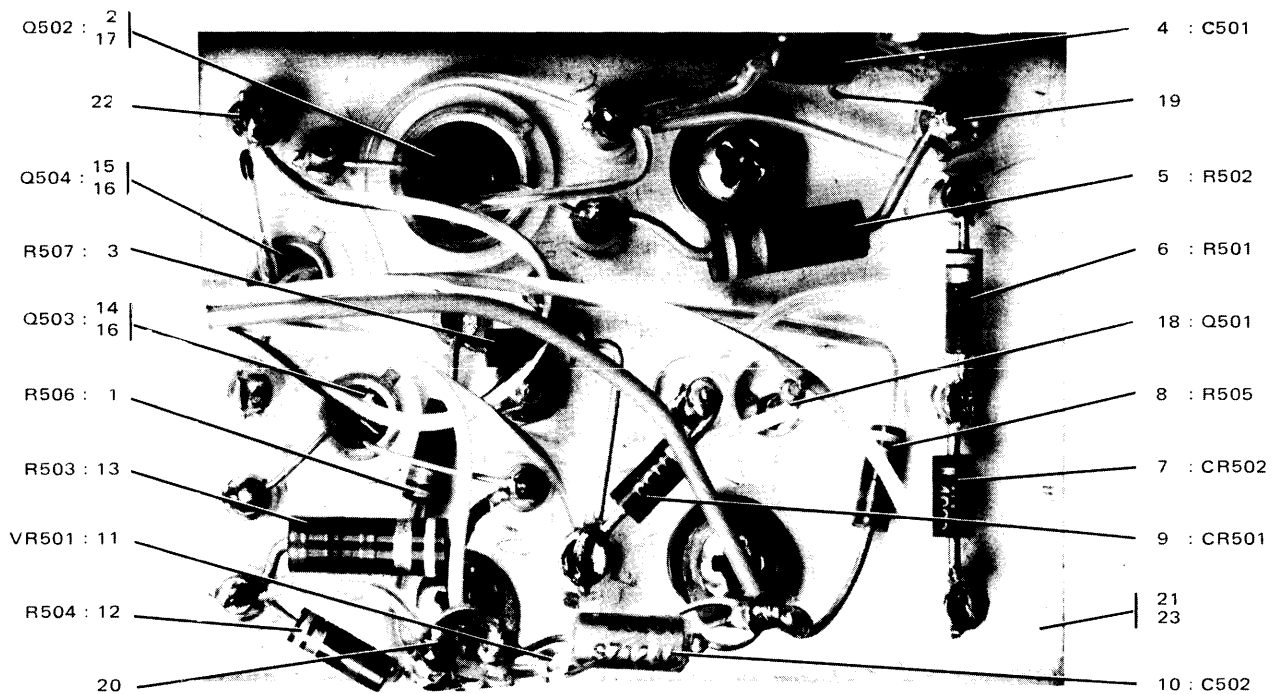

TP3-1042-017

Keep-Alive Power Switch 609-0928-001  
Figure 27

GROUP ASSEMBLY PARTS LIST

FIG - ITEM	PART NO	INDENT	DESCRIPTION	USABLE ON CODE	UNITS PER ASSY
27	20	4007-4HT	2 TERMINAL LUG, (V77147) 304-0015-000		1
		66-1660-40	2 NUT, SLFLKG, HEX, AL, 4-40 (V72962) 333-0605-000 (AP)		1
		MS51957-13	2 SCREW, MACH, STL, 4-40 X 1/4 (V96906) 343-0133-000 (AP)		1
	21	609-0927-001	2 BRACKET, PRESSED		1
	22	9L182-197AHT	3 TERMINAL STDF, (V12615) 306-1531-000		14
23	609-0926-001	3 BRACKET		1	
28	606-9884-001	1	BLANKER, IF, (SEE FIG 40-37 FOR NHA)		RF
	1	606-9716-001	2 COVER		1
	2	606-9713-001	2 TRANSFORMER, T301		1
	3	606-9713-001	2 TRANSFORMER, T302		1
	4	1N914	2 SEMICOND DEVICE, (V07688) 353-2906-000 CR302		1
	5	1N914	2 SEMICOND DEVICE, (V07688) 353-2906-000 CR301		1
	6	RCR05G102K	2 RESISTOR, FXD, CMPSN, 1K, 10%, 1/8W (V81349) 745-2341-000 R301		1
	7	RCR05G102K	2 RESISTOR, FXD, CMPSN, 1K, 10%, 1/8W (V81349) 745-2341-000 R302		1
	8	2C067104X0101A3	2 CAPACITOR, FXD, CER DIE, 0.1UF, 20%, 100V (V56289) 913-4240-040 C301		1

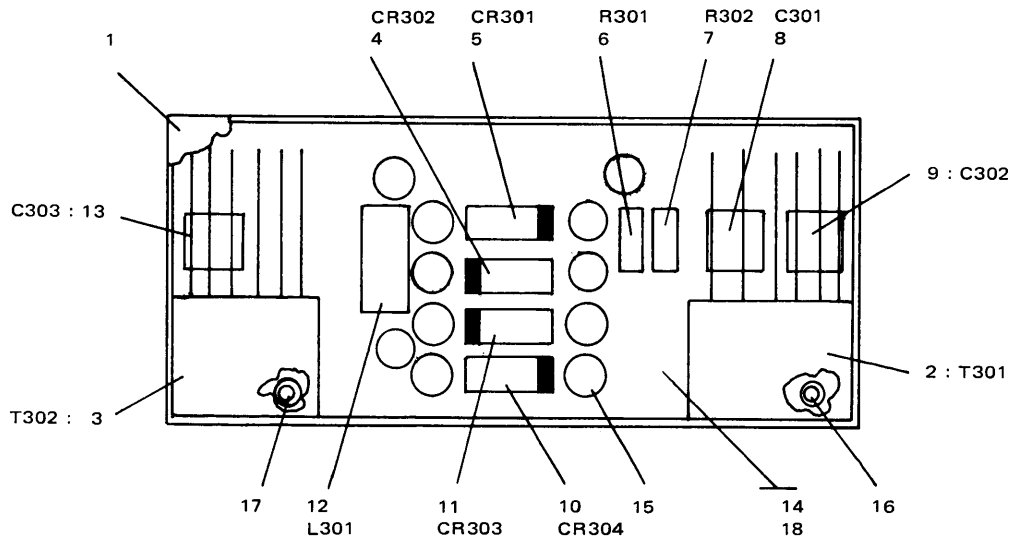

TP3-1043-019

IF Blanker 606-9884-001  
Figure 28

## GROUP ASSEMBLY PARTS LIST

FIG - ITEM	PART NO	INDENT	DESCRIPTION	USABLE ON CODE	UNITS PER ASSY
28	9	2C067104X0101A3	2 CAPACITOR,FXD, CER DIEI, 0.1UF, 20%, 100V (V56289) 913-4240-040 C302		1
	10	1N914	2 SEMICOND DEVICE, (V07688) 353-2906-000 CR304		1
	11	1N914	2 SEMICOND DEVICE, (V07688) 353-2906-000 CR303		1
	12	MS90537-49	2 COIL,RF, 1000UH (V96906) 240-2715-490 L301		1
	13	2C067104X0101A3	2 CAPACITOR,FXD, CER DIEI, 0.1UF, 20%, 100V (V56289) 913-4240-040 C303		1
	14	606-9885-001	2 CHASSIS, PRESSED		1
	15	SL441-434WHT	3 TERMINAL,STUD, (V12615) 306-2222-100		9
	16	SL354-351WHT	3 TERMINAL,FEEDTH, (V12615) 306-2474-010		4
	17	1P4-26A	3 TERMINAL,STUD, (V86577) 306-0972-000		2
	18	606-9715-001	3 CHASSIS		1
29		606-9708-001	1 AMPLIFIER, AUDIO (SEE FIG 26-16 FOR NHA)		RF
	1	RCR07G474KS	2 RESISTOR,FXD, CMPSN, 0.47MEGO, 10%, 1/4W (V81349) 745-0845-000 R1		AR
	1	RCR07G564KS	2 RESISTOR,FXD, CMPSN, 0.56MEGO, 10%, 1/4W (V81349) 745-0848-000 R1		AR
	1	RCR07G684KS	2 RESISTOR,FXD, CMPSN, 0.68MEGO, 10%, 1/4W (V81349) 745-0851-000 R1		AR
	1	RCR07G754JS	2 RESISTOR,FXD, CMPSN, 0.75MEGO, 5%, 1/4W (V81349) 745-0852-000 R1		AR
	1	RCR07G824KS	2 RESISTOR,FXD, CMPSN, 0.82MEGO, 10%, 1/4W (V81349) 745-0854-000 R1		AR
	2	150D475X0035B2	2 CAPACITOR,FXD, ELCTLT, 4.7UF, 20%, 35V (V56289) 184-7396-000 C2		1
	3	150D475X0035B2	2 CAPACITOR,FXD, ELCTLT, 4.7UF, 20%, 35V (V56289) 184-7396-000 C3		1
	4	RCR07G100KS	2 RESISTOR,FXD, CMPSN, 10 OHMS, 10%, 1/4W (V81349) 745-0677-000 R18		1
	5	RCR07G472KS	2 RESISTOR,FXD, CMPSN, 4.7K, 10%, 1/4W (V81349) 745-0773-000 R10		1
	6	RW70U1R00F	2 RESISTOR,FXD,WW, 1 OHM, 1%, 1.25W (V81349) 747-4230-010 R12		1
	7	2N3054	2 TRANSISTOR, (V07688) 352-0581-010 Q1		1
		MS35649-244	2 NUT,PLAIN,HEX, SST, 4-40 (V96906) 313-0043-000 (AP)		2
		MS35338-135	2 WASHER,LOCK, SST, 0.115 ID X 0.209 OD (V96906) 310-0279-000 (AP)		2
		2504-04-00-2220N	2 TERMINAL,LUG, (V78189) 304-0271-000 (AP)		1
		310-0046-000	2 WASHER,FLAT, SST, 0.147 ID X 0.312 OD (V79807) 310-0046-000 (AP)		4
		302-0646-050	2 WASHER,NM,SHLDR, PLSTC, 0.115 ID X 0.290 OD (V07596) 302-0646-050 (AP)		2
		43-66-1	2 INSULATOR,PL, (V13103) 352-9605-190 (AP)		1
		MS51937-16	2 SCREW,MACH, STL, 4-40 X 7/16 (V96906) 343-0136-000 (AP)		2

GROUP ASSEMBLY PARTS LIST

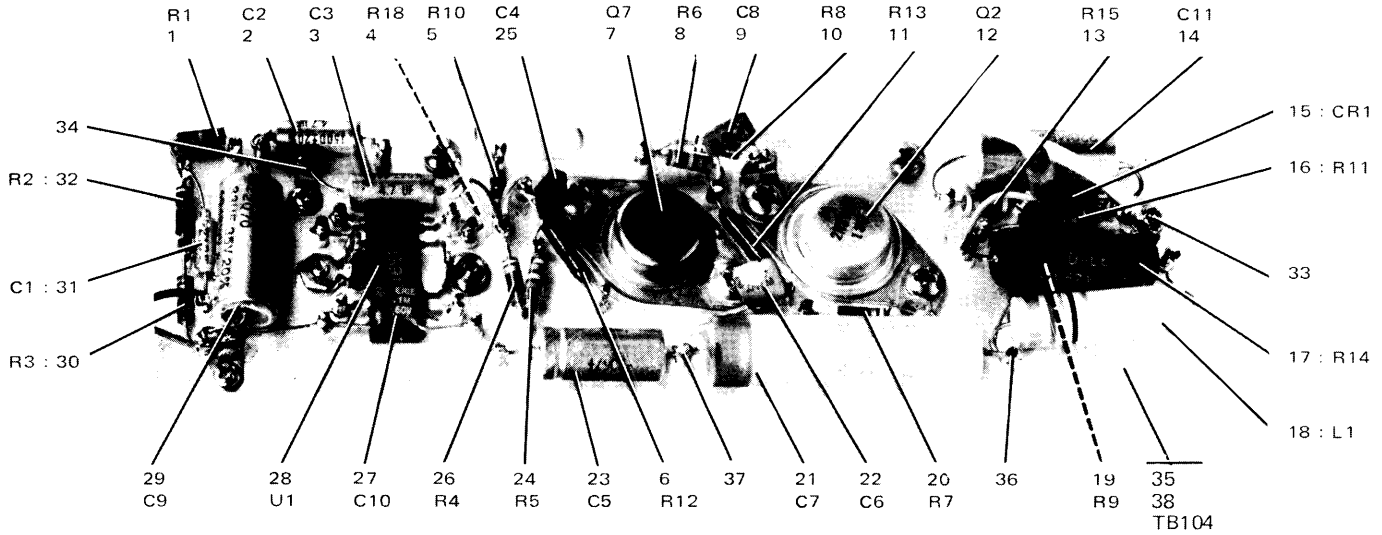

IP3-1044-017

Audio Amplifier 606-9708-001  
Figure 29

FIG - ITEM	PART NO	INDENT	DESCRIPTION	USABLE ON CODE	UNITS PER ASSY
29 - 8	RCR07G334KS	2	RESISTOR,FXD, CMPSN, 0.33MEGO, 10%, 1/4W (V81349) 745-0839-000 R6		1
9	2C067182X0101A3	2	CAPACITOR,FXD, CER DIEL, 0.0018UF, 20%, 100V (V56289) 913-4240-030 C8		1
10	RCR07G823KS	2	RESISTOR,FXD, CMPSN, 82K, 10%, 1/4W (V81349) 745-0818-000 R8		1
11	RW70U1R00F	2	RESISTOR,FXD,WW, 1 OHM, 1%, 1.25W (V81349) 747-4230-010 R13		1
12	2N3740	2	TRANSISTOR, (V07688) 352-0695-010 Q2		1
	P313-0156-00	2	NUT,PLAIN,HEX, NP BR3, 4-40 (V77250) 313-0156-000 (AP)		2
	MS35338-97	2	WASHER,LOCK, BRZ, 0.115 ID X 0.212 OD (V96906) 310-0076-000 (AP)		2
	4007-4HT	2	TERMINAL,LUG, (V77147) 304-0015-000 (AP)		2



## GROUP ASSEMBLY PARTS LIST

FIG - ITEM	PART NO	INDENT	DESCRIPTION	USABLE ON CODE	UNITS PER ASSY
29	MS51957-14	2	SCREW, MACH, STL, 4-40 X 5/16 (V96906)		2
			343-0134-000 (AP)		
13	RCR07G470KS	2	RESISTOR, FXD, CMPSN, 47 OHMS, 10%, 1/4W (V81349)		1
			745-0701-000 R15		
14	M39003-01-2026	2	CAPACITOR, FXD, ELCTLT, 220UF, 20%, 10V (V81349)		1
			184-9083-260 C11		
15	1N4003	2	SEMICONV DEVICE, (V04713) 353-6442-030 CR1		1
16	RCR20G102KS	2	RESISTOR, FXD, CMPSN, 1K, 10%, 1/2W (V81349)		1
			745-1352-000 R11		
17	RW67V3R3	2	RESISTOR, FXD, MW, 3.3 OHMS, 5%, 6.5W (V81349)		1
			747-5483-000 R14		
18	2890-30	2	COIL, RF, 27UH (V99800) 240-1620-000 L1		1
19	RCR20G102KS	2	RESISTOR, FXD, CMPSN, 1K, 10%, 1/2W (V81349)		1
			745-1352-000 R9		
20	RCR07G220KS	2	RESISTOR, FXD, CMPSN, 22 OHMS, 10%, 1/4W (V81349)		1
			745-0689-000 R7		
21	600D227G020DG5	2	CAPACITOR, FXD, ELCTLT, 220UF, M10XP75%, 20V		1
			(V56289) 183-1277-200 C7		
22	2C067473X0101A3	2	CAPACITOR, FXD, CER DIEL, 0.047UF, 20%, 100V		1
			(V56289) 913-4240-080 C6		
23	M39003-01-2067	2	CAPACITOR, FXD, ELCTLT, 22UF, 20%, 35V (V81349)		1
			184-9083-670 C5		
24	RCR07G183KS	2	RESISTOR, FXD, CMPSN, 18K, 10%, 1/4W (V81349)		1
			745-0794-000 R5		
25	K05SK102M	2	CAPACITOR, FXD, CER DIEL, 1000PF, 10%, 100V		1
			(V05197) 913-4489-360 C4		
26	RCR07G102KS	2	RESISTOR, FXD, CMPSN, 1K, 10%, 1/4W (V81349)		1
			745-0749-000 R4		
27	B131-050-651-104 M	2	CAPACITOR, FXD, CER DIEL, 0.1UF, 20%, 50V		1
			(V72982) 913-3279-200 C10		
28	GEL246S1	2	INTEGRATED CKT, (V03508) 351-1081-010 U1		1
	P313-0050-000	2	NUT, PLAIN, HEX, NP BRS, 2-56 (V77250)		2
			313-0050-000 (AP)		
	310-0075-000	2	WASHER, LOCK, BRZ, 0.088 ID X 0.165 OD (V79807)		2
			310-0075-000 (AP)		
	4019-4	2	TERMINAL, LUG, (V77147) 304-0085-000 (AP)		2
	P343-0298-000	2	SCREW, MACH, NP BRS, 2-56 X 3/16 (V77250)		2
			343-0298-000 (AP)		
29	M39003-01-2070	2	CAPACITOR, FXD, ELCTLT, 33UF, 20%, 35V (V81349)		1
			184-9083-700 C9		
30	RCR07G123KS	2	RESISTOR, FXD, CMPSN, 12K, 10%, 1/4W (V81349)		1
			745-0788-000 R3		
31	M39003-01-2108	2	CAPACITOR, FXD, ELCTLT, 0.33UF, 20%, 50V (V81349)		1
			184-9084-350 C1		
32	RCR07G753JS	2	RESISTOR, FXD, CMPSN, 75K, 5%, 1/4W (V81349)		1
			745-0816-000 R2		
33	4007-4HT	2	TERMINAL, LUG, (V77147) 304-0015-000		2
34	4040-2HT	2	TERMINAL, LUG, (V77147) 304-0014-000		1
	P313-0050-000	2	NUT, PLAIN, HEX, NP BRS, 2-56 (V77250)		3
			313-0050-000 (AP FOR 33,34)		
	310-0075-000	2	WASHER, LOCK, BRZ, 0.088 ID X 0.165 OD (V79807)		3
			310-0075-000 (AP FOR 33,34)		
	P343-0298-000	2	SCREW, MACH, NP BRS, 2-56 X 3/16 (V77250)		3
			343-0298-000 (AP FOR 33,34)		
35	606-9886-001	2	TERMINAL BOARD, TR104		1
36	SL441-434WHT	3	TERMINAL, STUD, (V12615) 306-2222-100		9
37	SL354-351WHT	3	TERMINAL, FEEDTH, (V12615) 306-2474-010		24
38	606-9431-001	3	TERMINAL BOARD		1

GROUP ASSEMBLY PARTS LIST

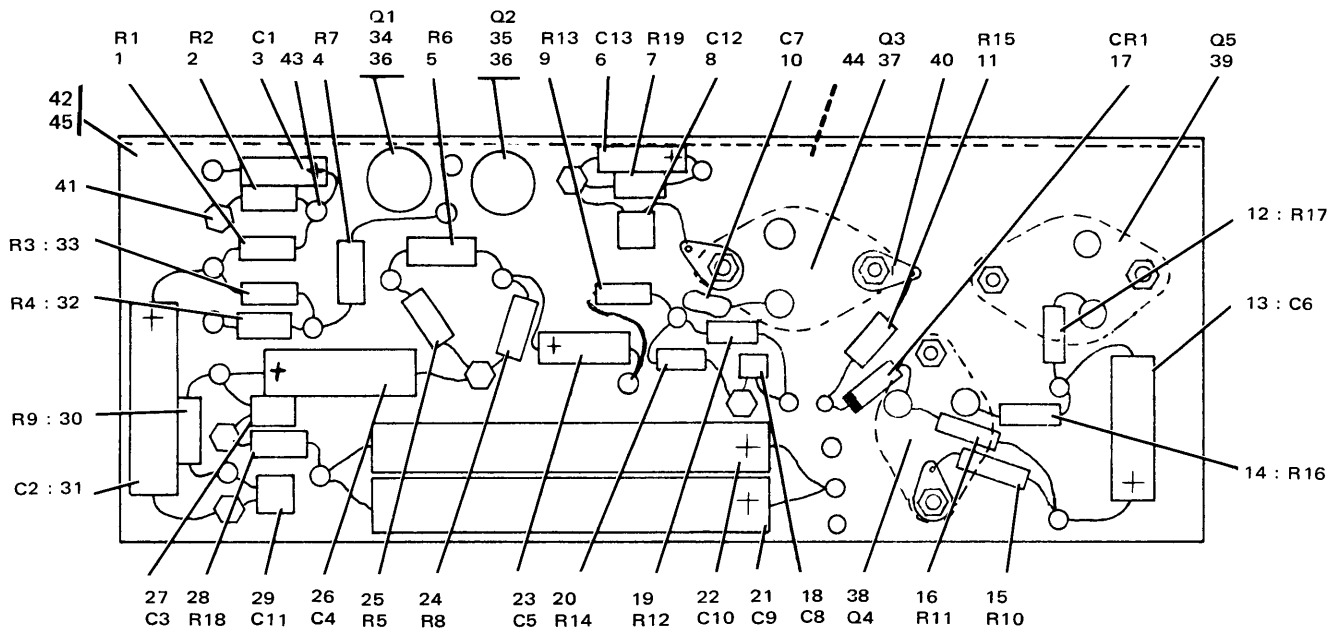

TP3-2230-019

Electronic Component Assembly 618-7105-001  
Figure 30

FIG - ITEM	PART NO	INDENT	DESCRIPTION	USABLE ON CODE	UNITS PER ASSY
30 •	618-7105-001	1	COMPONENT ASSY, ELECTRONIC (SEE FIG 26-16 FOR NHA)		RF
1	RCR07G274KS	2	RESISTOR,FXD, CMPSN, 0.27MEGO, 10%, 1/4W (V81349) 745-0836-000 R1		1
2	RCR07G223KS	2	RESISTOR,FXD, CMPSN, 22K, 10%, 1/4W (V81349) 745-0797-000 R2		1
3	150D474X9035A2	2	CAPACITOR,FXD, ELCTLT, 0.47UF, 10%, 35V (V56289) 184-7708-000 C1		1
4	RCR07G181KS	2	RESISTOR,FXD, CMPSN, 180 OHMS, 10%, 1/4W (V81349) 745-0722-000 R7		1
5	RCR07G822KS	2	RESISTOR,FXD, CMPSN, 8.2K, 10%, 1/4W (V81349) 745-0782-000 R6		1
6	M39003-03-0015	2	CAPACITOR,FXD, ELCTLT, 1000UF, 20%, 6V (V81349) 184-6329-140 C13		1
7	RCR07G150KS	2	RESISTOR,FXD, CMPSN, 15 OHMS, 10%, 1/4W (V81349) 745-0683-000 R19		1
8	8131-050-651-104 M	2	CAPACITOR,FXD, CER DIEL, 0.1UF, 20%, 50V (V72982) 913-3279-200 C12		1
9	RCR07G471KS	2	RESISTOR,FXD, CMPSN, 470 OHMS, 10%, 1/4W (V81349) 745-0737-000 R13		1
10	DM5F271J050WV	2	CAPACITOR,FXD, MICA DIEL, 270PF, 5%, 50V (V72136) 912-4141-470 C7		1
11	RCR07G100KS	2	RESISTOR,FXD, CMPSN, 10 OHMS, 10%, 1/4W (V81349) 745-0677-000 R15		1
12	RW70U1R00F	2	RESISTOR,FXD,WW, 1 OHM, 1%, 1.25W (V81349) 747-4230-010 R17		1

## GROUP ASSEMBLY PARTS LIST

FIG - ITEM	PART NO	INDENT	DESCRIPTION	USABLE ON CODE	UNITS PER ASSY
30 13	M39003-03-0045	2	CAPACITOR,FXD, ELCTLT, 330UF, 20%, 15V (V81349) 184-6329-420 C6		1
14	RW70U1R00F	2	RESISTOR,FXD,WH, 1 OHM, 1%, 1.25W (V81349) 747-4230-010 R16		1
15	RCR07G101KS	2	RESISTOR,FXD, CMPSN, 100 OHMS, 10%, 1/4W (V81349) 745-0713-000 R10		1
16	RCR07G331KS	2	RESISTOR,FXD, CMPSN, 330 OHMS, 10%, 1/4W (V81349) 745-0731-000 R11		1
17	1N4003	2	SEMICONV DEVICE, (V04713) 353-6442-030 CR1		1
18	8131-050-651-104 M	2	CAPACITOR,FXD, CER DIEL, 0.1UF, 20%, 50V (V72982) 913-3279-200 C8		1
19	RCR07G222KS	2	RESISTOR,FXD, CMPSN, 2.2K, 10%, 1/4W (V81349) 745-0761-000 R12		1
20	RCR07G221KS	2	RESISTOR,FXD, CMPSN, 220 OHMS, 10%, 1/4W (V81349) 745-0725-000 R14		1
21	600D507G020DL5	2	CAPACITOR,FXD, ELCTLT, 500UF, M10XP75%, 20V (V56289) 183-1277-990 C9		1
22	600D507G020DL5	2	CAPACITOR,FXD, ELCTLT, 500UF, M10XP75%, 20V (V56289) 183-1277-990 C10		1
23	150D226X9035R2	2	CAPACITOR,FXD, ELCTLT, 22UF, 10%, 35V (V56289) 184-7710-000 C5		1
24	RCR07G222KS	2	RESISTOR,FXD, CMPSN, 2.2K, 10%, 1/4W (V81349) 745-0761-000 R8		1
25	RCR07G471KS	2	RESISTOR,FXD, CMPSN, 470 OHMS, 10%, 1/4W (V81349) 745-0737-000 R5		1
26	150D226X9035R2	2	CAPACITOR,FXD, ELCTLT, 22UF, 10%, 35V (V56289) 184-7710-000 C4		1
27	8131-050-651-104 M	2	CAPACITOR,FXD, CER DIEL, 0.1UF, 20%, 50V (V72982) 913-3279-200 C3		1
28	RCR07G471KS	2	RESISTOR,FXD, CMPSN, 470 OHMS, 10%, 1/4W (V81349) 745-0737-000 R18		1
29	8131-050-651-104 M	2	CAPACITOR,FXD, CER DIEL, 0.1UF, 20%, 50V (V72982) 913-3279-200 C11		1
30	RCR07G221KS	2	RESISTOR,FXD, CMPSN, 220 OHMS, 10%, 1/4W (V81349) 745-0725-000 R9		1
31	150D226X9035R2	2	CAPACITOR,FXD, ELCTLT, 22UF, 10%, 35V (V56289) 184-7710-000 C2		1
32	RCR07G182KS	2	RESISTOR,FXD, CMPSN, 1.8K, 10%, 1/4W (V81349) 745-0758-000 R4		1
33	RCR07G103KS	2	RESISTOR,FXD, CMPSN, 10K, 10%, 1/4W (V81349) 745-0785-000 R3		1
34	2N2222A	2	TRANSISTOR, (V07688) 352-0661-020 Q1		1
35	2N2907A	2	TRANSISTOR, (V07688) 352-0551-010 Q2		1
36	T1533	2	HOLDER,XSTR, (V98291) 352-9509-000		2
37	2N3054	2	TRANSISTOR, (V07688) 352-0581-010 Q3 (EFF TO CI 73045)		1
37	2N3766	2	TRANSISTOR, (V07688) 352-0689-010 Q3 (EFF CI 73045)		1
38	2N3054	2	TRANSISTOR, (V07688) 352-0581-010 Q4 (EFF TO CI 73045)		1
38	2N3766	2	TRANSISTOR, (V07688) 352-0689-010 Q4 (EFF CI 73045)		1
39	2504-04-00-2220N	2	TERMINAL,LUG, (V78189) 304-0271-000 (EFF TO CI 72413)		3
39	4007-4HT	2	TERMINAL,LUG, (V77147) 304-0015-000 (EFF CI 72413)		3
	P313-0051-000	2	NUT,PLAIN,HEX, NP BR5, 4-40 (V77250) 313-0051-000 (AP FOR 37-39)		4
	310-0054-000	2	WASHER,FLAT, BR5, 0.125 ID X 0.312 OD (V79807) 310-0054-000 (AP FOR 37-39)		4
	MS35338-97	2	WASHER,LOCK, BRZ, 0.115 ID X 0.212 OD (V96906) 310-0076-000 (AP FOR 37-39)		4

GROUP ASSEMBLY PARTS LIST

FIG - ITEM	PART NO	INDENT	DESCRIPTION	USABLE ON CODE	UNITS PER ASSY
30	43-66-1	2	INSULATOR, PL. (V13103) 352-9605-190 (AP FOR 37-39)		2
	302-0646-050	2	WASHER, NM, SHLDR, PLSTC, 0.115 ID X 0.290 OD (V07496) 302-0646-050 (AP FOR 37-39)		4
	547-8177-003	2	BUSHING, SHIELD, (AP FOR 37-39)		4
	P343-0287-000	2	SCREW, MACH, NP BR, 4-40 X 3/8 (V77250) 343-0287-000 (AP FOR 37-39)		4
40	2N3740	2	TRANSISTOR, (V07688) 352-0695-010 Q5		1
	P313-0051-000	2	NUT, PLAIN, HEX, NP BR, 4-40 (V77250) 313-0051-000 (AP)		2
	MS35338-97	2	WASHER, LOCK, BRZ, 0.115 ID X 0.212 OD (V96906) 310-0076-000 (AP)		2
	P343-0287-000	2	SCREW, MACH, NP BR, 4-40 X 3/8 (V77250) 343-0287-000 (AP)		2
41	AB406D	2	TERMINAL, GND, (V12615) 306-1311-000		6
	P313-0050-000	2	NUT, PLAIN, HEX, NP BR, 2-56 (V77250) 313-0050-000 (AP)		6
	310-0075-000	2	WASHER, LOCK, BRZ, 0.088 ID X 0.165 OD (V79807) 310-0075-000 (AP)		6
42	618-7104-001	2	TERMINAL BOARD, PRSD TB104		1
43	SL354-351WHT	3	TERMINAL, FEEDTH, (V12615) 306-2474-010		22
44	R22NCFMA1-40	3	NUT, SLFLKG, CD PL STL, 4-40 (V72962) 333-0839-000		2
45	618-7103-001	3	TERMINAL BOARD		1
31 -	624-5781-001	1	CIRCUIT CARD ASSY, DCU A9 (SEE FIG 1-15 FOR NHA) AD, AW, AX RF		
1	MC7402P	2	INTEGRATED CKT, (V04713) 351-7628-010 A9U12		1
2	8121-050-651-104 Z	2	CAPACITOR, FXD, CER DIEL, 0.1UF, M20XP80%, 50V (V72982) 913-3279-500 A9C32		1
3	MC7401P	2	INTEGRATED CKT, (V04713) 351-7627-010 A9U22		1
4	RCR05G332K	2	RESISTOR, FXD, CMPSN, 3.3K, 10%, 1/8W (V81349) 745-2359-000 A9R23		1
5	SN7474N	2	INTEGRATED CKT, (V01295) 351-7739-010 A9U32		1
6	8121-050-651-104 Z	2	CAPACITOR, FXD, CER DIEL, 0.1UF, M20XP80%, 50V (V72982) 913-3279-500 A9C33		1
7	T055-10K1F	2	RESISTOR, FXD, FILM, 10K, 1%, 1/8W (V11502) 705-1454-630 A9R15		1
8	RCR05G103K	2	RESISTOR, FXD, CMPSN, 10K, 10%, 1/8W (V81349) 745-2377-000 A9R13		1
9	754	2	TRANSFORMER, AF, (V27549) 677-0397-010 A9T1		1
10	M39003-01-2043	2	CAPACITOR, FXD, ELCTLT, 2.2UF, 10%, 20V (V81349) 184-9083-430 A9C17		1
11	T055-7-5K1F	2	RESISTOR, FXD, FILM, 7.5K, 1%, 1/8W (V11502) 705-1454-600 A9R27		1
12	T055-1541-1F	2	RESISTOR, FXD, FILM, 1.54K, 1%, 1/8W (V11502) 705-1470-670 A9R29		1
13	T055-14-7K1F	2	RESISTOR, FXD, FILM, 14.7K, 1%, 1/8W (V11502) 705-1454-670 A9R14		1
14	T055-13-1K1F	2	RESISTOR, FXD, FILM, 13.3K, 1%, 1/8W (V11502) 705-1454-660 A9R32		1

GROUP ASSEMBLY PARTS LIST

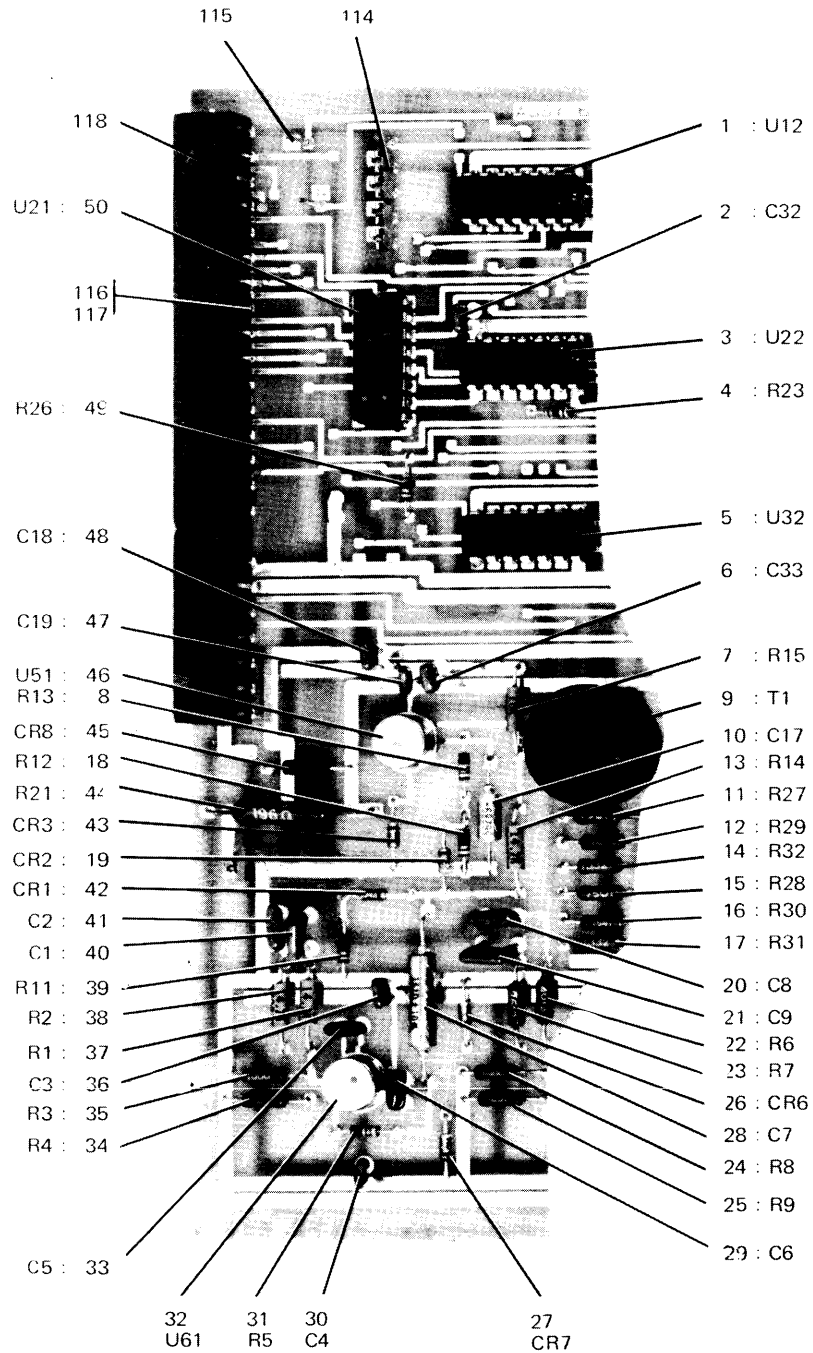

TP3-2232-027

DCU Circuit Card Assembly (A9) 624-5781-001  
Figure 31 (Sheet 1 of 2)

GROUP ASSEMBLY PARTS LIST

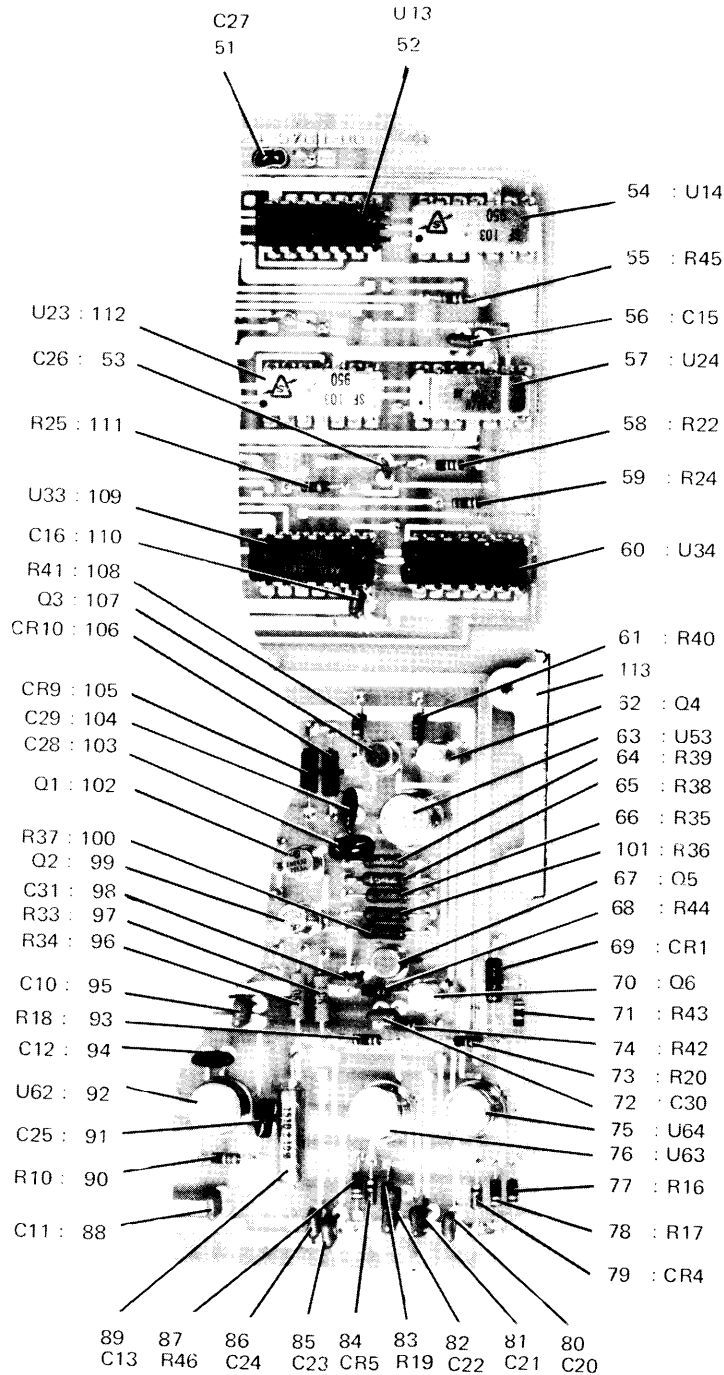

TP3-2232-02

DCU Circuit Card Assembly (A9) 624-5781-001  
 Figur 31 (Sheet 2 of 2)

## GROUP ASSEMBLY PARTS LIST

FIG - ITEM	PART NO	INDENT	DESCRIPTION	USABLE ON CODE	UNITS PER ASSY
31	15	T055-7-5K1F	2 RESISTOR,FXD, FILM, 7.5K, 1%, 1/8W (V11502) 705-1454-600 A9R28		1
	16	T055-1541-1F	2 RESISTOR,FXD, FILM, 1.54K, 1%, 1/8W (V11502) 705-1470-670 A9R30		1
	17	T055-13-1K1F	2 RESISTOR,FXD, FILM, 13.3K, 1%, 1/8W (V11502) 705-1454-660 A9R31		1
	18	RCR05G152K	2 RESISTOR,FXD, CMPSN, 1.5K, 10%, 1/8W (V81349) 745-2347-000 A9R12		1
	19	1N4454	2 SEMICOND DEVICE, (V03508) 353-3644-010 A9CR2		1
	20	8131-100W5R104K	2 CAPACITOR,FXD, CER DIEL, 0.1UF, 10%, 100V (V72982) 913-3118-190 A9C8		1
	21	8131-100W5R104K	2 CAPACITOR,FXD, CER DIEL, 0.1UF, 10%, 100V (V72982) 913-3118-190 A9C9		1
	22	T055-26-1K1F	2 RESISTOR,FXD, FILM, 26.1K, 1%, 1/8W (V11502) 705-1454-730 A9R6		1
	23	T055-26-1K1F	2 RESISTOR,FXD, FILM, 26.1K, 1%, 1/8W (V11502) 705-1454-730 A9R7		1
	24	T055-100-1F	2 RESISTOR,FXD, FILM, 100 OHMS, 1%, 1/8W (V11502) 705-1454-150 A9R8		1
	25	T055-100-1F	2 RESISTOR,FXD, FILM, 100 OHMS, 1%, 1/8W (V11502) 705-1454-150 A9R9		1
	26	1N4454	2 SEMICOND DEVICE, (V03508) 353-3644-010 A9CR6		1
	27	1N4454	2 SEMICOND DEVICE, (V03508) 353-3644-010 A9CR7		1
	28	151D115X9020W2	2 CAPACITOR,FXD, ELCTLT, 1.1UF, 10%, 20V (V56289) 184-4363-000 A9C7		1
	29	DM5C030D050WV	2 CAPACITOR,FXD, MICA DIEL, 3PF, 0.5PF, 50V (V72136) 912-4141-070 A9C6		1
	30	913-3279-430	2 CAPACITOR,FXD, CER DIEL, 0.01PF, M20XP80X, 50V (V13499) 913-3279-430 A9C4		1
	31	RCR05G104K	2 RESISTOR,FXD, CMPSN, 100K, 10%, 1/8W (V81349) 745-2413-000 A9R5		1
	32	USB770939	2 AMPLIFIER,OPR, (V07263) 351-7140-010 A9U61		1
	33	DM5C100D050WV	2 CAPACITOR,FXD, MICA DIEL, 10PF, 0.5PF, 50V (V72136) 912-4141-020 A9C5		1
	34	T055-100-1F	2 RESISTOR,FXD, FILM, 100 OHMS, 1%, 1/8W (V11502) 705-1454-150 A9R4		1
	35	T055-100-1F	2 RESISTOR,FXD, FILM, 100 OHMS, 1%, 1/8W (V11502) 705-1454-150 A9R3		1
	36	913-3279-430	2 CAPACITOR,FXD, CER DIEL, 0.01PF, M20XP80X, 50V (V13499) 913-3279-430 A9C3		1
	37	T055-14-7K1F	2 RESISTOR,FXD, FILM, 14.7K, 1%, 1/8W (V11502) 705-1454-670 A9R1		1
	38	T055-14-7K1F	2 RESISTOR,FXD, FILM, 14.7K, 1%, 1/8W (V11502) 705-1454-670 A9R2		1
	39	RCR05G152K	2 RESISTOR,FXD, CMPSN, 1.5K, 10%, 1/8W (V81349) 745-2347-000 A9R11		1
	40	8131-100W5R104K	2 CAPACITOR,FXD, CER DIEL, 0.1UF, 10%, 100V (V72982) 913-3118-190 A9C1		1
	41	8131-100W5R104K	2 CAPACITOR,FXD, CER DIEL, 0.1UF, 10%, 100V (V72982) 913-3118-190 A9C2		1
	42	1N4454	2 SEMICOND DEVICE, (V03508) 353-3644-010 A9CR1		1
	43	1N4454	2 SEMICOND DEVICE, (V03508) 353-3644-010 A9CR3		1
	44	RN65D1960F	2 RESISTOR,FXD, FILM, 196 OHMS, 1%, 1/2W (V81349) 705-7062-000 A9R21		1
	45	1N751	2 SEMICOND DEVICE, (V07688) 353-2709-000 A9CR8		1
	46	LM301AH	2 INTEGRATED CKT, (V27014) 351-1105-010 A9U51		1
	47	913-3279-430	2 CAPACITOR,FXD, CER DIEL, 0.01PF, M20XP80X, 50V (V13499) 913-3279-430 A9C19		1
	48	913-3279-430	2 CAPACITOR,FXD, CER DIEL, 0.01PF, M20XP80X, 50V (V13499) 913-3279-430 A9C18		1
	49	RCR05G332K	2 RESISTOR,FXD, CMPSN, 3.3K, 10%, 1/8W (V81349) 745-2359-000 A9R26		1
	50	U6B931259	2 INTEGRATED CKT, (V07263) 351-7430-040 A9U21		1

GROUP ASSEMBLY PARTS LIST

FIG - ITEM	PART NO	INDENT	DESCRIPTION	USABLE ON CODE	UNITS PER ASSY
31 51	8121-050-651-104 Z	2	CAPACITOR,FXD, CER DIEL, 0.1UF, M20XP80X, 50V (V72982) 913-3279-500 A9C27		1
52	SN7474N	2	INTEGRATED CKT, (V01295) 351-7739-010 A9U13		1
53	8121-100W5R102K	2	CAPACITOR,FXD, CER DIEL, 1000PF, 10X, 100V (V72982) 913-3118-430 A9C26		1
54	SF10303	2	INTEGRATED CKT, (V93332) 351-7318-040 A9U14		1
55	RCR05G332K	2	RESISTOR,FXD, CMPSN, 3.3K, 10X, 1/8W (V81349) 745-2359-000 A9R45		1
56	8121-050-651-104 Z	2	CAPACITOR,FXD, CER DIEL, 0.1UF, M20XP80X, 50V (V72982) 913-3279-500 A9C15		1
57	RF101D	2	INTEGRATED CKT, (V49956) 351-7297-040 A9U24		1
58	RCR05G103K	2	RESISTOR,FXD, CMPSN, 10K, 10X, 1/8W (V81349) 745-2377-000 A9R22		1
59	RCR05G332K	2	RESISTOR,FXD, CMPSN, 3.3K, 10X, 1/8W (V81349) 745-2359-000 A9R24		1
60	MC7404P	2	INTEGRATED CKT, (V04713) 351-7630-010 A9U34		1
61	RCR05G103K	2	RESISTOR,FXD, CMPSN, 10K, 10X, 1/8W (V81349) 745-2377-000 A9R40		1
62	2N2907A	2	TRANSISTOR, (V07688) 352-0551-010 A9Q4		1
63	LM301AH	2	INTEGRATED CKT, (V27014) 351-1105-010 A9U53		1
64	T055-100-1F	2	RESISTOR,FXD, FILM, 100 OHMS, 1X, 1/8W (V11502) 705-1454-150 A9R39		1
65	T055-1542-1F	2	RESISTOR,FXD, FILM, 15.4K, 1X, 1/8W (V11502) 705-1470-920 A9R38		1
66	T055-5-11K1F	2	RESISTOR,FXD, FILM, 5.11K, 1X, 1/8W (V11502) 705-1454-560 A9R35		1
67	2N2222A	2	TRANSISTOR, (V07688) 352-0661-020 A9Q5		1
68	RCR05G102K	2	RESISTOR,FXD, CMPSN, 1K, 10X, 1/8W (V81349) 745-2341-000 A9R44		1
69	1N963B	2	SEMICOND DEVICE, (V07688) 353-3174-000 A9CR11		1
70	2N2907A	2	TRANSISTOR, (V07688) 352-0551-010 A9Q6		1
71	RCR07G392KS	2	RESISTOR,FXD, CMPSN, 3.9K, 10X, 1/4W (V81349) 745-0770-000 A9R43		1
72	913-3279-430	2	CAPACITOR,FXD, CER DIEL, 0.01PF, M20XP80X, 50V (V13499) 913-3279-430 A9C30		1
73	RCR05G223K	2	RESISTOR,FXD, CMPSN, 22K, 10X, 1/8W (V81349) 745-2389-000 A9R20		1
74	RCR05G102K	2	RESISTOR,FXD, CMPSN, 1K, 10X, 1/8W (V81349) 745-2341-000 A9R42		1
75	LM301AH	2	INTEGRATED CKT, (V27014) 351-1105-010 A9U64		1
76	LM301AH	2	INTEGRATED CKT, (V27014) 351-1105-010 A9U63		1
77	RCR05G102K	2	RESISTOR,FXD, CMPSN, 1K, 10X, 1/8W (V81349) 745-2341-000 A9R16		1
78	RCR05G102K	2	RESISTOR,FXD, CMPSN, 1K, 10X, 1/8W (V81349) 745-2341-000 A9R17		1
79	1N4454	2	SEMICOND DEVICE, (V03508) 353-3644-010 A9CR4		1
80	913-3279-430	2	CAPACITOR,FXD, CER DIEL, 0.01PF, M20XP80X, 50V (V13499) 913-3279-430 A9C20		1
81	913-3279-430	2	CAPACITOR,FXD, CER DIEL, 0.01PF, M20XP80X, 50V (V13499) 913-3279-430 A9C21		1
82	8131-100W5R104K	2	CAPACITOR,FXD, CER DIEL, 0.1UF, 10X, 100V (V72982) 913-3118-190 A9C22		1
83	RCR05G822K	2	RESISTOR,FXD, CMPSN, 8.2K, 10X, 1/8W (V81349) 745-2374-000 A9R19		1
84	1N4454	2	SEMICOND DEVICE, (V03508) 353-3644-010 A9CR5		1
85	913-3279-430	2	CAPACITOR,FXD, CER DIEL, 0.01PF, M20XP80X, 50V (V13499) 913-3279-430 A9C23		1
86	913-3279-430	2	CAPACITOR,FXD, CER DIEL, 0.01PF, M20XP80X, 50V (V13499) 913-3279-430 A9C24		1
87	RCR05G102K	2	RESISTOR,FXD, CMPSN, 1K, 10X, 1/8W (V81349) 745-2341-000 A9R46		1
88	913-3279-430	2	CAPACITOR,FXD, CER DIEL, 0.01PF, M20XP80X, 50V (V13499) 913-3279-430 A9C11		1



## GROUP ASSEMBLY PARTS LIST

FIG - ITEM	PART NO	INDENT	DESCRIPTION	USABLE ON CODE	UNITS PER ASSY
31	89	151D115X9020W2	2 CAPACITOR,FXD, ELCTLT, 1.1UF, 10%, 20V (V56289) 1A4-9363-000 A9C13		1
	90	RCR05G104K	2 RESISTOR,FXD, CMPSN, 100K, 10%, 1/8W (V81349) 745-2413-000 A9R10		1
	91	DM5C030D050WV	2 CAPACITOR,FXD, MICA DIEL, 3PF, 0.5PF, 50V (V72136) 912-4141-070 A9C25		1
	92	U5B770939	2 AMPLIFIER,OPR, (V07263) 351-7140-010 A9U62		1
	93	RCR05G472K	2 RESISTOR,FXD, CMPSN, 4.7K, 10%, 1/8W (V81349) 745-2365-000 A9R18		1
	94	DM5C100D050WV	2 CAPACITOR,FXD, MICA DIEL, 10PF, 0.5PF, 50V (V72136) 912-4141-020 A9C12		1
	95	913-3279-430	2 CAPACITOR,FXD, CER DIEL, 0.01PF, M20XP80%, 50V (V13499) 913-3279-430 A9C10		1
	96	T055-10K1F	2 RESISTOR,FXD, FILM, 10K, 1%, 1/8W (V11502) 705-1454-630 A9R34		1
	97	T055-10K1F	2 RESISTOR,FXD, FILM, 10K, 1%, 1/8W (V11502) 705-1454-630 A9R33		1
	98	913-3279-430	2 CAPACITOR,FXD, CER DIEL, 0.01PF, M20XP80%, 50V (V13499) 913-3279-430 A9C31		1
	99	2N2432	2 TRANSISTOR, (V07688) 352-0441-000 A9Q2		1
100	T055-5-11K1F		2 RESISTOR,FXD, FILM, 5.11K, 1%, 1/8W (V11502) 705-1454-560 A9R37		1
101	T055-5-11K1F		2 RESISTOR,FXD, FILM, 5.11K, 1%, 1/8W (V11502) 705-1454-560 A9R36		1
102	2N2432		2 TRANSISTOR, (V07688) 352-0441-000 A9Q1		1
103	DM5F151J050WV		2 CAPACITOR,FXD, MICA DIEL, 150PF, 5%, 50V (V72136) 912-4141-400 A9C28		1
104	DM5C100D050WV		2 CAPACITOR,FXD, MICA DIEL, 10PF, 0.5PF, 50V (V72136) 912-4141-020 A9C29		1
105	1N751		2 SEMICOND DEVICE, (V07688) 353-2709-000 A9CR9		1
106	1N751		2 SEMICOND DEVICE, (V07688) 353-2709-000 A9CR10		1
107	2N2222A		2 TRANSISTOR, (V07688) 352-0661-020 A9Q3		1
108	RCR05G560K		2 RESISTOR,FXD, CMPSN, 56 OHMS, 10%, 1/8W (V81349) 745-2295-000 A9R41		1
109	MC7400P		2 INTEGRATED CKT, (V04713) 351-7629-010 A9U33		1
110	8121-050-651-104 Z		2 CAPACITOR,FXD, CER DIEL, 0.1UF, M20XP80%, 50V (V72982) 913-3279-500 A9C16		1
111	RCR05G151K		2 RESISTOR,FXD, CMPSN, 150 OHMS, 10%, 1/8W (V81349) 745-2311-000 A9R25		1
112	SF10303		2 INTEGRATED CKT, (V93332) 351-7318-040 A9U23		1
113	624-5782-001 M851923-314		2 HANDLE		1
			2 PIN,SPRING, SST, 0.078 DIA X 1/4 (V96906) 311-0465-000 (AP)		1
114	B5171-150-2G		2 CLIP,ELEC, (V29593) 367-1508-010		2
115	372-2601-037		2 CONTACT,ELEC, 372-2601-037		10
116	372-2234-010		2 CONTACT,ELEC, (V13499) 372-2234-010		24
117	372-2234-020		2 CONTACT,ELEC, (V13499) 372-2234-020		23
118	372-2623-033		2 HOUSING,CONN,EL, 372-2623-033		1
32	-	609-0552-001	1 OSCILLATOR ASSY, VARIABLE BEAT FREQUENCY A2A1 (SEE FIG 25-1 FOR NHA)	V	RF
	-	609-0552-002	1 OSCILLATOR ASSY, VARIABLE BEAT FREQUENCY A2A1 (SEE FIG 23-1 AND 25-1 FOR NHA)	W	RF
	1		DELETED		
	2	609-0548-001	2 COVER	V	1

GROUP ASSEMBLY PARTS LIST

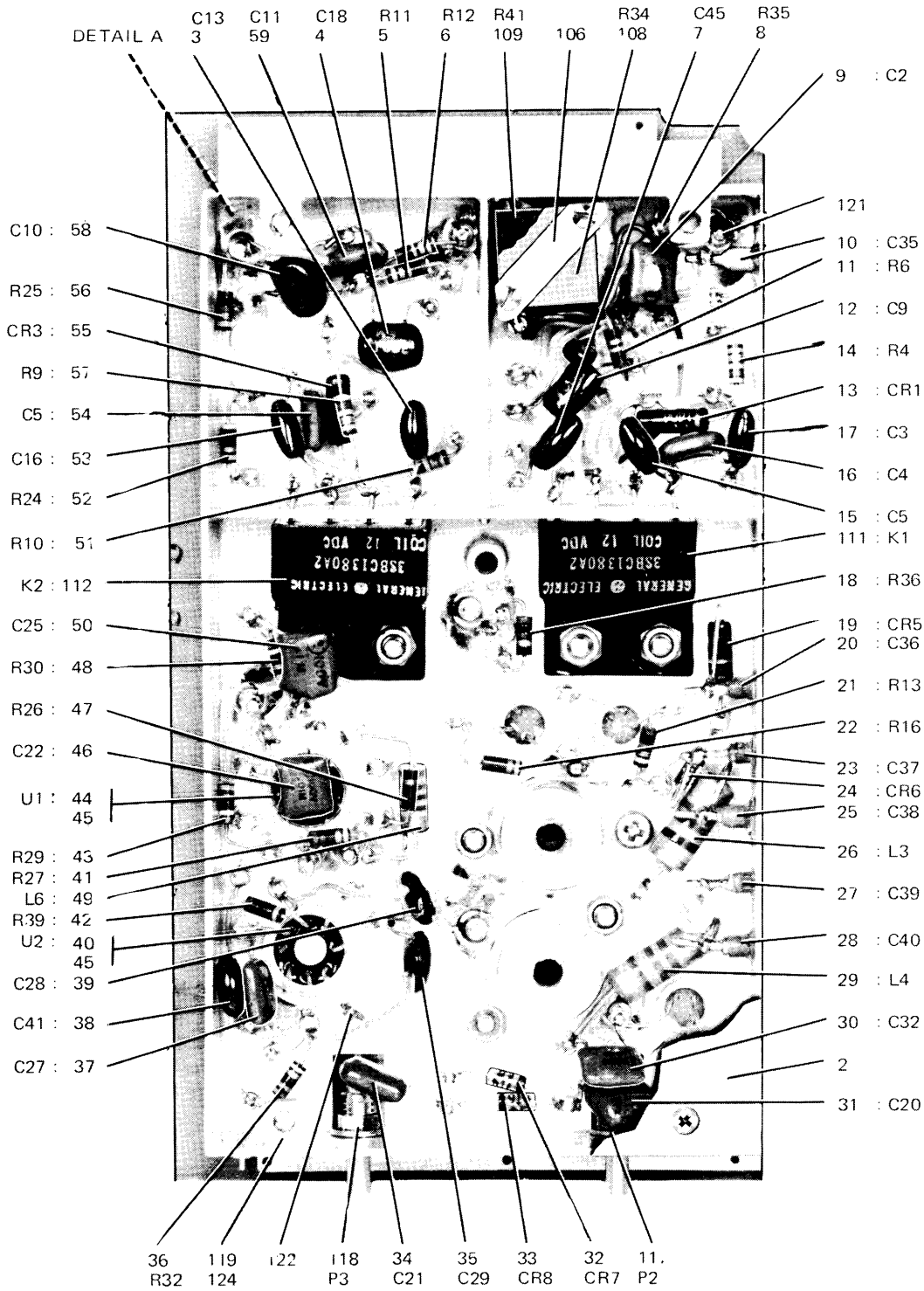

TP3-2231-027

Variable Beat Frequency Oscillator Assembly (A2A1) 609-0552-001, -002  
Figure 32 (Sheet 1 of 2)

GROUP ASSEMBLY PARTS LIST

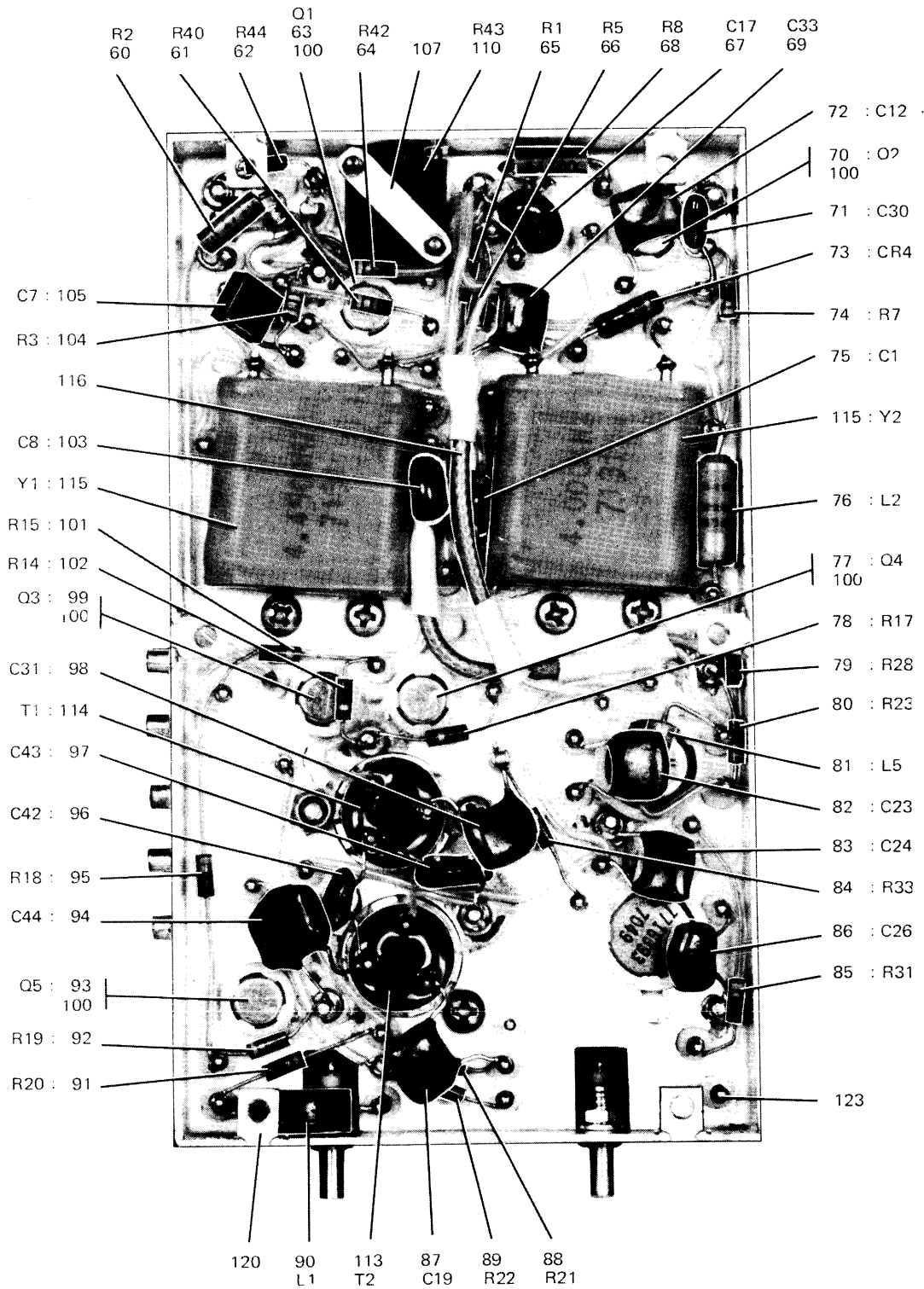

DETAIL A

TP3-2231-027

Variable Beat Frequency Oscillator Assembly (A2A1) 609-0552-001, -002  
Figure 32 (Sheet 2 of 2)

GROUP ASSEMBLY PARTS LIST

FIG - ITEM	PART NO	INDENT	DESCRIPTION	USABLE ON CODE	UNITS PER ASSY
32	2 609-1569-001	2	COVER	W	1
	P342-0142-000	2	SCREW, MACH. NP BRS. 2-56 X 3/16 (V77250) 342-0142-000 (AP)		5
	3 DM5E200D050WV	2	CAPACITOR, FXD, MICA DIEI., 20PF, 0.5PF, 50V (V72136) 912-4141-150 A2A1C13		AR
	3 TC20-110	2	CAPACITOR, FXD, CER DIEI., 20PF, 1PF, 500V (V09052) 913-0052-000 A2A1C13		AR
	3 TC20-92	2	CAPACITOR, FXD, CER DIEI., 20PF, 1PF, 500V (V09052) 913-0053-000 A2A1C13		AR
	3 TC20-89	2	CAPACITOR, FXD, CER DIEI., 20PF, 1PF, 500V (V09052) 913-0054-000 A2A1C13		AR
	3 TC20-90	2	CAPACITOR, FXD, CER DIEI., 20PF, 1PF, 500V (V09052) 913-0055-000 A2A1C13		AR
	3 TC20-82	2	CAPACITOR, FXD, CER DIEI., 20PF, 1PF, 500V (V09052) 913-0056-000 A2A1C13		AR
	3 TC20-81	2	CAPACITOR, FXD, CER DIEI., 20PF, 1PF, 500V (V09052) 913-0057-000 A2A1C13		AR
	3 TC20-94	2	CAPACITOR, FXD, CER DIEI., 20PF, 1PF, 500V (V09052) 913-0058-000 A2A1C13		AR
	3 DA934-023	2	CAPACITOR, FXD, CER DIEI., 20PF, 2PF, 500V (V71590) 913-0232-000 A2A1C13		AR
	3 DA934-024	2	CAPACITOR, FXD, CER DIEI., 20PF, 2PF, 500V (V71590) 913-0233-000 A2A1C13		AR
	3 DA934-025	2	CAPACITOR, FXD, CER DIEI., 20PF, 2PF, 500V (V71590) 913-0234-000 A2A1C13		AR
	4 DM5F361J050WV	2	CAPACITOR, FXD, MICA DIEI., 360PF, 5%, 50V (V72136) 912-4141-500 A2A1C18		1
	5 RCR05G153K	2	RESISTOR, FXD, CMPSN, 15K, 10%, 1/8W (V81349) 745-2383-000 A2A1R11	V	1
	5 RCR05G153K	2	RESISTOR, FXD, CMPSN, 15K, 10%, 1/8W (V81349) 745-2383-000 A2A1R11 (EFF TO CI 72295)	W	1
	5 RCR05G133JS	2	RESISTOR, FXD, CMPSN, 13K, 5%, 1/8W (V81349) 745-1863-760 A2A1R11 (EFF CI 72295)	W	1
	6 RCR05G153K	2	RESISTOR, FXD, CMPSN, 15K, 10%, 1/8W (V81349) 745-2383-000 A2A1R12	V	1
	6 RCR05G153K	2	RESISTOR, FXD, CMPSN, 15K, 10%, 1/8W (V81349) 745-2383-000 A2A1R12 (EFF TO CI 72295)	W	1
	6 RCR05G153JS	2	RESISTOR, FXD, CMPSN, 15K, 5%, 1/8W (V81349) 745-1863-770 A2A1R12 (EFF CI 72295)	W	1
	7 DM5F201J050WV	2	CAPACITOR, FXD, MICA DIEI., 200PF, 5%, 50V (V72136) 912-4141-440 A2A1C45		1
	8 RCR05G333K	2	RESISTOR, FXD, CMPSN, 33K, 10%, 1/8W (V81349) 745-2395-000 A2A1R35		1
	9 CK05B103M	2	CAPACITOR, FXD, CER DIEI., 0.01UF, 20%, 100V (V81349) 913-5019-660 A2A1C2		1
	10 1251-003	2	FILTER, RAD INTR., (V72982) 241-5010-010 A2A1C35		1
	11 RCR05G153K	2	RESISTOR, FXD, CMPSN, 15K, 10%, 1/8W (V81349) 745-2383-000 A2A1R6	V	1
	11 RCR05G153K	2	RESISTOR, FXD, CMPSN, 15K, 10%, 1/8W (V81349) 745-2383-000 A2A1R6 (EFF TO CI 72295)	W	1
	11 RCR05G153JS	2	RESISTOR, FXD, CMPSN, 15K, 5%, 1/8W (V81349) 745-1863-770 A2A1R6 (EFF CI 72295)		1
	12 DM5F101J050WV	2	CAPACITOR, FXD, MICA DIEI., 100PF, 5%, 50V (V72136) 912-4141-050 A2A1C9		1
	13 MV1404	2	SEMICONV DEVICE, (V04713) 922-6100-020 A2A1CR1		1
	14 RCR05G474K	2	RESISTOR, FXD, CMPSN, 470K, 10%, 1/8W (V81349) 745-2437-000 A2A1R4		1
	15 DM5E200D050WV	2	CAPACITOR, FXD, MICA DIEI., 20PF, 0.5PF, 50V (V72136) 912-4141-150 A2A1C5		AR
	15 TC20-110	2	CAPACITOR, FXD, CER DIEI., 20PF, 1PF, 500V (V09052) 913-0052-000 A2A1C5		AR
	15 TC20-92	2	CAPACITOR, FXD, CER DIEI., 20PF, 1PF, 500V (V09052) 913-0053-000 A2A1C5		AR

## GROUP ASSEMBLY PARTS LIST

FIG - ITEM	PART NO	INDENT	DESCRIPTION	USABLE ON CODE	UNITS PER ASSY
32	15	TC20-89	2 CAPACITOR,FXD, CER DIEI, 20PF, 1PF, 500V (V09052) 913-0054-000 A2A1C5		AR
	15	TC20-90	2 CAPACITOR,FXD, CER DIEI, 20PF, 1PF, 500V (V09052) 913-0055-000 A2A1C5		AR
	15	TC20-82	2 CAPACITOR,FXD, CER DIEI, 20PF, 1PF, 500V (V09052) 913-0056-000 A2A1C5		AR
	15	TC20-81	2 CAPACITOR,FXD, CER DIEI, 20PF, 1PF, 500V (V09052) 913-0057-000 A2A1C5		AR
	15	TC20-94	2 CAPACITOR,FXD, CER DIEI, 20PF, 1PF, 500V (V09052) 913-0058-000 A2A1C5		AR
	15	DA934-023	2 CAPACITOR,FXD, CER DIEI, 20PF, 2PF, 500V (V71590) 913-0232-000 A2A1C5		AR
	15	DA934-024	2 CAPACITOR,FXD, CER DIEI, 20PF, 2PF, 500V (V71590) 913-0233-000 A2A1C5		AR
	15	DA934-025	2 CAPACITOR,FXD, CER DIEI, 20PF, 2PF, 500V (V71590) 913-0234-000 A2A1C5		AR
	16	CK058X103M	2 CAPACITOR,FXD, CER DIEI, 0.01UF, 20%, 100V (V81349) 913-5019-660 A2A1C4		1
	17	DM5E200D050WV	2 CAPACITOR,FXD, MICA DIEI, 20PF, 0.5PF, 50V (V72136) 912-4141-150 A2A1C3		AR
	17	DM5E240D050WV	2 CAPACITOR,FXD, MICA DIEI, 24PF, 0.5PF, 50V (V72136) 912-4141-160 A2A1C3		AR
	17	DM5E270J050WV	2 CAPACITOR,FXD, MICA DIEI, 27PF, 5%, 50V (V72136) 912-4141-180 A2A1C3		AR
	17	DM5E300J050WV	2 CAPACITOR,FXD, MICA DIEI, 30PF, 5%, 50V (V72136) 912-4141-200 A2A1C3		AR
	17	DM5E330J050WV	2 CAPACITOR,FXD, MICA DIEI, 33PF, 5%, 50V (V72136) 912-4141-220 A2A1C3		AR
	17	DM5E360J050WV	2 CAPACITOR,FXD, MICA DIEI, 36PF, 5%, 50V (V72136) 912-4141-240 A2A1C3		AR
	17	DM5E430J050WV	2 CAPACITOR,FXD, MICA DIEI, 43PF, 5%, 50V (V72136) 912-4141-260 A2A1C3		AR
	18	RCR05G151K	2 RESISTOR,FXD, CMPSN, 150 OHMS, 10%, 1/8W (V81349) 745-2311-000 A2A1R36		1
	19	1N914	2 SEMICOND DEVICE, (V07688) 353-2906-000 A2A1CR5		1
	20	1251-003	2 FILTER,RAD INTR, (V72982) 241-5010-010 A2A1C36		1
	21	RCR05G103K	2 RESISTOR,FXD, CMPSN, 10K, 10%, 1/8W (V81349) 745-2377-000 A2A1R13		1
	22	RCR05G222K	2 RESISTOR,FXD, CMPSN, 2.2K, 10%, 1/8W (V81349) 745-2353-000 A2A1R16		1
	23	1251-003	2 FILTER,RAD INTR, (V72982) 241-5010-010 A2A1C37		1
	24	1N914	2 SEMICOND DEVICE, (V07688) 353-2906-000 A2A1CR6		1
	25	1251-003	2 FILTER,RAD INTR, (V72982) 241-5010-010 A2A1C38		1
	26	MS90537-41	2 COIL,RF, 220UH (V96906) 240-2715-410 A2A1L3		1
	27	1251-003	2 FILTER,RAD INTR, (V72982) 241-5010-010 A2A1C39		1
	28	1251-003	2 FILTER,RAD INTR, (V72982) 241-5010-010 A2A1C40		1
	29	MS90537-41	2 COIL,RF, 220UH (V96906) 240-2715-410 A2A1L4		1
	30	CK058X103M	2 CAPACITOR,FXD, CER DIEI, 0.01UF, 20%, 100V (V81349) 913-5019-660 A2A1C32		1
	31	2C067104X0101A3	2 CAPACITOR,FXD, CER DIEI, 0.1UF, 20%, 100V (V56289) 913-4240-040 A2A1C20		1
	32	1N914	2 SEMICOND DEVICE, (V07688) 353-2906-000 A2A1CR7		1
	33	1N914	2 SEMICOND DEVICE, (V07688) 353-2906-000 A2A1CR8		1
	34	2C067104X0101A3	2 CAPACITOR,FXD, CER DIEI, 0.1UF, 20%, 100V (V56289) 913-4240-040 A2A1C21		1
	35	DM5E330J050WV	2 CAPACITOR,FXD, MICA DIEI, 33PF, 5%, 50V (V72136) 912-4141-220 A2A1C29		1
	36	RCR05G561K	2 RESISTOR,FXD, CMPSN, 560 OHMS, 10%, 1/8W (V81349) 745-2332-000 A2A1R32		AR
	36	RCR05G122K	2 RESISTOR,FXD, CMPSN, 1.2K, 10%, 1/8W (V81349) 745-2344-000 A2A1R32		AR
	36	RCR05G182K	2 RESISTOR,FXD, CMPSN, 1.8K, 10%, 1/8W (V81349) 745-2350-000 A2A1R32		AR

GROUP ASSEMBLY PARTS LIST

FIG - ITEM	PART NO	INDENT	DESCRIPTION	USABLE ON CODE	UNITS PER ASSY
32 36	RCR05G222K	2	RESISTOR,FXD, CMPSN, 2.2K, 10%, 1/8W (V81349) 745-2353-000 A2A1R32		AR
36	RCR05G272K	2	RESISTOR,FXD, CMPSN, 2.7K, 10%, 1/8W (V81349) 745-2356-000 A2A1R32		AR
36	RCR05G332K	2	RESISTOR,FXD, CMPSN, 3.3K, 10%, 1/8W (V81349) 745-2359-000 A2A1R32		AR
36	RCR05G392K	2	RESISTOR,FXD, CMPSN, 3.9K, 10%, 1/8W (V81349) 745-2362-000 A2A1R32		AR
36	RCR05G472K	2	RESISTOR,FXD, CMPSN, 4.7K, 10%, 1/8W (V81349) 745-2365-000 A2A1R32		AR
36	RCR05G562K	2	RESISTOR,FXD, CMPSN, 5.6K, 10%, 1/8W (V81349) 745-2368-000 A2A1R32		AR
36	RCR05G682K	2	RESISTOR,FXD, CMPSN, 6.8K, 10%, 1/8W (V81349) 745-2371-000 A2A1R32		AR
37	CK05Bx103M	2	CAPACITOR,FXD, CER DIEL, 0.01UF, 20%, 100V (V81349) 913-5019-660 A2A1C27		1
38	DM5E680J050WV	2	CAPACITOR,FXD, MICA DIEL, 68PF, 5%, 50V (V72136) 912-4141-330 A2A1C41		1
39	DM5E560J050WV	2	CAPACITOR,FXD, MICA DIEL, 56PF, 5%, 50V (V72136) 912-4141-310 A2A1C2A		1
40	U5R7716393	2	INTEGRATED CKT, (V07263) 351-1008-010 A2A1U2		1
41	RCR05G682K	2	RESISTOR,FXD, CMPSN, 6.8K, 10%, 1/8W (V81349) 745-2371-000 A2A1R27		1
42	RCR05G750JS	2	RESISTOR,FXD, CMPSN, 75 OHMS, 5%, 1/8W (V81349) 745-1863-220 A2A1R39		1
43	RCR05G392K	2	RESISTOR,FXD, CMPSN, 3.9K, 10%, 1/8W (V81349) 745-2362-000 A2A1R29		1
44	MC1396G	2	INTEGRATED CKT, (V04713) 351-0043-010 A2A1U1		1
45	T1532	2	HOLDER,XSTR, (V98291) 352-9508-000		2
46	CK05Bx103M	2	CAPACITOR,FXD, CER DIEL, 0.01UF, 20%, 100V (V81349) 913-5019-660 A2A1C22		1
47	RCR05G222K	2	RESISTOR,FXD, CMPSN, 2.2K, 10%, 1/8W (V81349) 745-2353-000 A2A1R26		1
48	RCR05G392K	2	RESISTOR,FXD, CMPSN, 3.9K, 10%, 1/8W (V81349) 745-2362-000 A2A1R30		1
49	MS75085-11	2	COIL,RF, 220UH (V96906) 240-2723-060 A2A1L6		1
50	2C067104X0101A3	2	CAPACITOR,FXD, CER DIEL, 0.1UF, 20%, 100V (V56289) 913-4240-040 A2A1C25		1
51	RCR05G474K	2	RESISTOR,FXD, CMPSN, 470K, 10%, 1/8W (V81349) 745-2437-000 A2A1R10		1
52	RCR05G472K	2	RESISTOR,FXD, CMPSN, 4.7K, 10%, 1/8W (V81349) 745-2365-000 A2A1R24		1
53	DM5E240D050WV	2	CAPACITOR,FXD, MICA DIEL, 24PF, 0.5PF, 50V (V72136) 912-4141-160 A2A1C16		1
54	CK05Bx103M	2	CAPACITOR,FXD, CER DIEL, 0.01UF, 20%, 100V (V81349) 913-5019-660 A2A1C15		1
55	MV1404	2	SEMICONV DEVICE, (V04713) 922-6100-020 A2A1CR3		1
56	RCR05G103K	2	RESISTOR,FXD, CMPSN, 10K, 10%, 1/8W (V81349) 745-2377-000 A2A1R25		1
57	RCR05G474K	2	RESISTOR,FXD, CMPSN, 470K, 10%, 1/8W (V81349) 745-2437-000 A2A1R9		1
58	DM5F401J050WV	2	CAPACITOR,FXD, MICA DIEL, 400PF, 5%, 50V (V72136) 912-4141-520 A2A1C10		1
59	CK05Bx103M	2	CAPACITOR,FXD, CER DIEL, 0.01UF, 20%, 100V (V81349) 913-5019-660 A2A1C11		1
60	T055-5-11K1F	2	RESISTOR,FXD, FILM, 5.11K, 1%, 1/8W (V11502) 705-1454-560 A2A1R2		1
61	RCR05G563K	2	RESISTOR,FXD, CMPSN, 56K, 10%, 1/8W (V81349) 745-2404-000 A2A1R40		1
62	RCR05G102K	2	RESISTOR,FXD, CMPSN, 1K, 10%, 1/8W (V81349) 745-2341-000 A2A1R44		1
63	S29119	2	TRANSISTOR, (V07263) 352-0440-030 A2A1Q1		1

## GROUP ASSEMBLY PARTS LIST

FIG - ITEM	PART NO	INDENT	DESCRIPTION	USABLE ON CODE	UNITS PER ASSY
32	64	RCR05G103K	2 RESISTOR,FXD, CMPSN, 10K, 10%, 1/8W (V81349) 745-2377-000 A2A1R42		1
	65	RCR05G472K	2 RESISTOR,FXD, CMPSN, 4.7K, 10%, 1/8W (V81349) 745-2365-000 A2A1R1	V	1
	65	RCR05G472K	2 RESISTOR,FXD, CMPSN, 4.7K, 10%, 1/8W (V81349) 745-2365-000 A2A1R1 (EFF TO CI 72295)	W	1
	65	RCR05G472JS	2 RESISTOR,FXD, CMPSN, 4.7K, 5%, 1/8W (V81349) 745-1863-650 A2A1R1 (EFF CI 72295)	W	1
	66	RCR05G153K	2 RESISTOR,FXD, CMPSN, 15K, 10%, 1/8W (V81349) 745-2383-000 A2A1R5	V	1
	66	RCR05G153K	2 RESISTOR,FXD, CMPSN, 15K, 10%, 1/8W (V81349) 745-2383-000 A2A1R5 (EFF TO CI 72295)	W	1
	66	RCR05G133JS	2 RESISTOR,FXD, CMPSN, 13K, 5%, 1/8W (V81349) 745-1863-760 A2A1R5 (EFF CI 72295)	W	1
	67	DM5F401J050WV	2 CAPACITOR,FXD, MICA DIEI, 400PF, 5%, 50V (V72136) 912-4141-520 A2A1C17		1
	68	T055-5-11K1F	2 RESISTOR,FXD, FILM, 5.11K, 1%, 1/8W (V11502) 705-1454-560 A2A1R8		1
	69	CK05BX103M	2 CAPACITOR,FXD, CER DIEI, 0.01UF, 20%, 100V (V81349) 913-5019-660 A2A1C33		1
	70	S29119	2 TRANSISTOR, (V07263) 352-0440-030 A2A1Q2		1
	71	2C067104X0101A3	2 CAPACITOR,FXD, CER DIEI, 0.1UF, 20%, 100V (V56289) 913-4240-040 A2A1C30		1
	72	CK05BX103M	2 CAPACITOR,FXD, CER DIEI, 0.01UF, 20%, 100V (V81349) 913-5019-660 A2A1C12		1
	73	1N914	2 SEMICOND DEVICE, (V07688) 353-2906-000 A2A1CR4		1
	74	RCR05G472K	2 RESISTOR,FXD, CMPSN, 4.7K, 10%, 1/8W (V81349) 745-2365-000 A2A1R7	V	1
	74	RCR05G472K	2 RESISTOR,FXD, CMPSN, 4.7K, 10%, 1/8W (V81349) 745-2365-000 A2A1R7 (EFF TO CI 72295)	W	1
	74	RCR05G472JS	2 RESISTOR,FXD, CMPSN, 4.7K, 5%, 1/8W (V81349) 745-1863-650 A2A1R7 (EFF CI 72295)	W	1
	75	DM5F361J050WV	2 CAPACITOR,FXD, MICA DIEI, 360PF, 5%, 50V (V72136) 912-4141-500 A2A1C1		1
	76	MS90537-41	2 COIL,RF, 220UH (V96906) 240-2715-410 A2A1L2		1
	77	2N2222A	2 TRANSISTOR, (V07688) 352-0661-020 A2A1Q4		1
	78	RCR05G222K	2 RESISTOR,FXD, CMPSN, 2.2K, 10%, 1/8W (V81349) 745-2353-000 A2A1R17		1
	79	RCR05G102K	2 RESISTOR,FXD, CMPSN, 1K, 10%, 1/8W (V81349) 745-2341-000 A2A1R28		1
	80	RCR05G102K	2 RESISTOR,FXD, CMPSN, 1K, 10%, 1/8W (V81349) 745-2341-000 A2A1R23		1
	81	MS75085-11	2 COIL,RF, 220UH (V96906) 240-2723-060 A2A1L5		1
	82	2C067104X0101A3	2 CAPACITOR,FXD, CER DIEI, 0.1UF, 20%, 100V (V56289) 913-4240-040 A2A1C23		1
	83	CK05BX103M	2 CAPACITOR,FXD, CER DIEI, 0.01UF, 20%, 100V (V81349) 913-5019-660 A2A1C24		1
	84	RCR05G680K	2 RESISTOR,FXD, CMPSN, 68 OHMS, 10%, 1/8W (V81349) 745-2298-000 A2A1R33		1
	85	RCR05G182K	2 RESISTOR,FXD, CMPSN, 1.8K, 10%, 1/8W (V81349) 745-2350-000 A2A1R31		1
	86	DM5F201J050WV	2 CAPACITOR,FXD, MICA DIEI, 200PF, 5%, 50V (V72136) 912-4141-440 A2A1C26		1
	87	2C067104X0101A3	2 CAPACITOR,FXD, CER DIEI, 0.1UF, 20%, 100V (V56289) 913-4240-040 A2A1C19		1
	88	RCR05G561K	2 RESISTOR,FXD, CMPSN, 560 OHMS, 10%, 1/8W (V81349) 745-2332-000 A2A1R21		1
	89	RCR05G561K	2 RESISTOR,FXD, CMPSN, 560 OHMS, 10%, 1/8W (V81349) 745-2332-000 A2A1R22		1
	90	MS90537-60	2 COIL,RF, 820UH (V96906) 240-2715-600 A2A1L1		1
	91	RCR05G102K	2 RESISTOR,FXD, CMPSN, 1K, 10%, 1/8W (V81349) 745-2341-000 A2A1R20		1

GROUP ASSEMBLY PARTS LIST

FIG - ITEM	PART NO	INDENT	DESCRIPTION	USABLE ON CODE	UNITS PER ASSY
32 92	RCR05G103K	2	RESISTOR,FXD, CMPSN, 10K, 10%, 1/8W (V81349) 745-2377-000 A2A1R19		1
93	2N2222A	2	TRANSISTOR, (V07688) 352-0661-020 A2A1Q5		1
94	D71F821J0	2	CAPACITOR,FXD, MICA DIEI, 820PF, 5%, 100V (V00953) 912-2093-220 A2A1C44		1
95	RCR05G222K	2	RESISTOR,FXD, CMPSN, 2.2K, 10%, 1/8W (V81349) 745-2353-000 A2A1R18		1
96	DM5E200D050WV	2	CAPACITOR,FXD, MICA DIEI, 20PF, 0.5PF, 50V (V72136) 912-4141-150 A2A1C42		1
97	D71F821J0	2	CAPACITOR,FXD, MICA DIEI, 820PF, 5%, 100V (V00953) 912-2093-220 A2A1C43		1
98	2C067104X0101A3	2	CAPACITOR,FXD, CER DIEI, 0.1UF, 20%, 100V (V56289) 913-4240-040 A2A1C31		1
99	2N2222A	2	TRANSISTOR, (V07688) 352-0661-020 A2A1Q3		1
100	T1533	2	HOLDER,XSTR, (V98291) 352-9509-000		5
101	RCR05G222K	2	RESISTOR,FXD, CMPSN, 2.2K, 10%, 1/8W (V81349) 745-2353-000 A2A1R15		1
102	RCR05G222K	2	RESISTOR,FXD, CMPSN, 2.2K, 10%, 1/8W (V81349) 745-2353-000 A2A1R14		1
103	DM5F271J050WV	2	CAPACITOR,FXD, MICA DIEI, 270PF, 5%, 50V (V72136) 912-4141-470 A2A1C8		1
104	RCR05G474K	2	RESISTOR,FXD, CMPSN, 470K, 10%, 1/8W (V81349) 745-2437-000 A2A1R13		1
105	CK05BX103M	2	CAPACITOR,FXD, CER DIEI, 0.01UF, 20%, 100V (V81349) 913-5019-660 A2A1C7		1
106	772-4689-001	2	STRAP,RETAINING		1
107	609-0185-001	2	STRAP,THREADED		1
	P313-0166-000	2	NUT,PLAIN,HEX, NP BRS, 0-80 (V77250) 313-0166-000 (AP FOR 106,107)		2
	P321-0297-000	2	SCREW,MACH, NP BRS, 0-80 X 5/8 (V77250) 321-0297-000 (AP FOR 106,107)		2
108	3292L1-203	2	RESISTOR,VAR, 20K, 10%, 1/2W (V81349) 380-1080-620 A2A1R34		1
109	3292L1-203	2	RESISTOR,VAR, 20K, 10%, 1/2W (V81349) 380-1080-620 A2A1R41		1
110	3292L1-502	2	RESISTOR,VAR, 5K, 10%, 1/2W (V81349) 380-1080-600 A2A1R43		1
111	3SBC1380A2	2	RELAY,AMT, (V01526) 974-0479-220 A2A1K1		1
112	3SBC1380A2	2	RELAY,AMT, (V01526) 974-0479-220 A2A1K2		1
113	A289	2	TRANSFORMER,IF, (V81815) 278-0390-020 A2A1T2		1
114	A289	2	TRANSFORMER,IF, (V81815) 278-0390-020 A2A1T1		1
	68-1660-26	2	NUT,SLFLKG,HEX, AL, 2-56 (V72962) 333-0604-000 (AP FOR 111-114)		8
	MS51957-2	2	SCREW,MACH, SST, 2-56 X 3/16 (V96906) 343-0123-000 (AP FOR 111-114)		8
115	289-7179-010M70	2	XTAL UNIT SET, (V75378) 289-7179-010 A2A1Y1,Y2 (MATCHED SET)		1
116	RG178BU	2	CABLE,RF, (V81349) 425-1538-000		AR
117	141-1002-0002	2	CONNECTOR,RCPT, ELEC (V98278) 357-7353-010 A2A1P2		1
118	141-1002-0002	2	CONNECTOR,RCPT, ELEC (V98278) 357-7353-010 A2A1P3		1
	302-4800-000	2	WASHER,NM, FBR, 0.116 ID X 1/4 OD (V74921) 302-4800-000 (AP FOR 117,118)		2
119	609-0551-001	2	CHASSIS ASSY	V	1
119	609-0551-002	2	CHASSIS ASSY	W	1
120	609-1558-001	3	FASTENER,ANGLE	W	10
121	SS5170	3	TERMINAL,FEEDTH, (V86577) 306-0989-000		11
122	SL441-434WHT	3	TERMINAL,STUD, (V12615) 306-2222-100		16
123	SL354-351WHT	3	TERMINAL,FEEDTH, (V12615) 306-2474-010		50
124	609-1567-001	3	CHASSIS	V	1
124	609-0544-001	3	CHASSIS,BRAZED	W	1



GROUP ASSEMBLY PARTS LIST

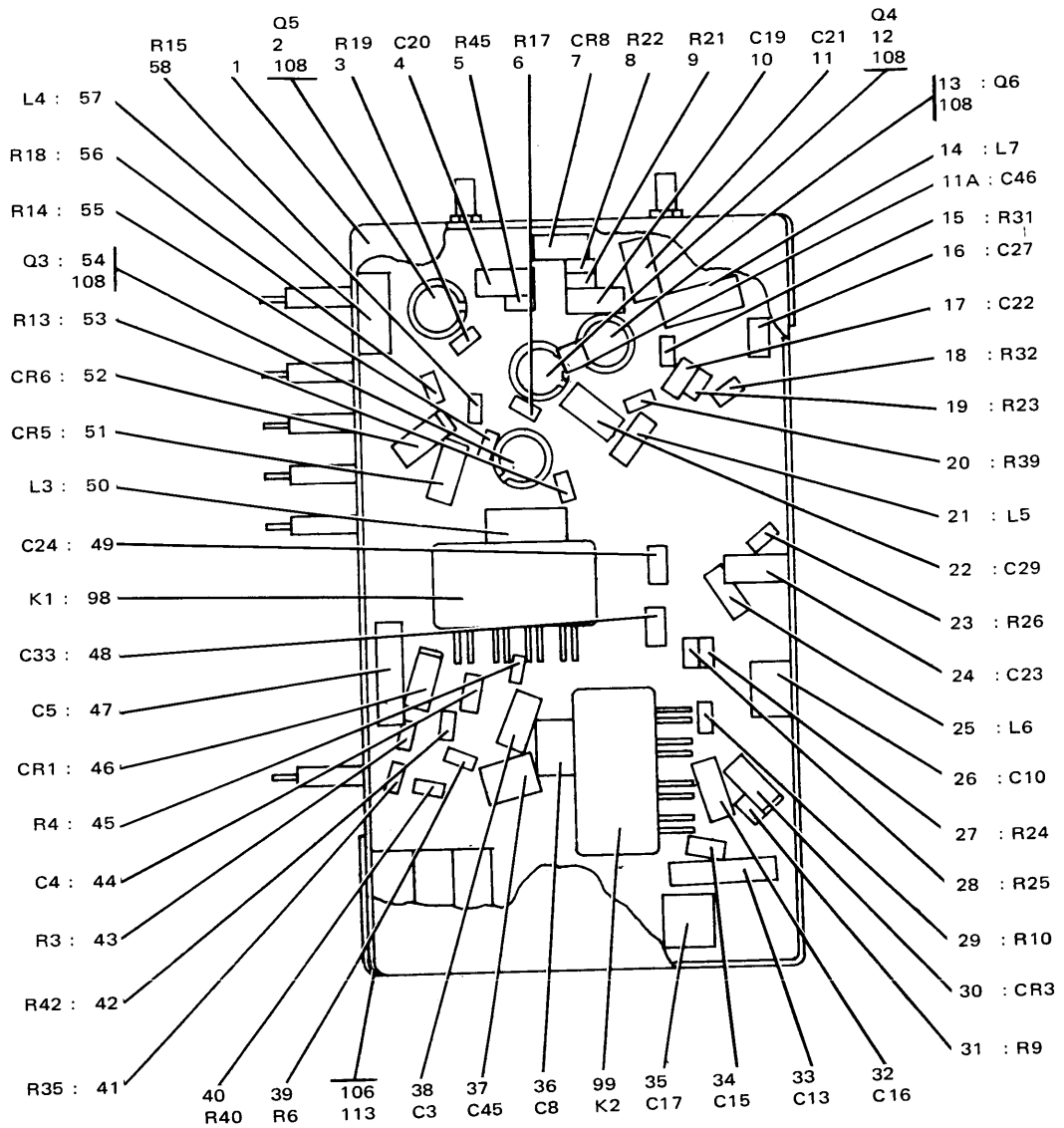

TP3-2239-029

Variable Beat Frequency Oscillator Assembly (A2A1) 618-7705-001, -002  
Figure 33 (Sheet 1 of 2)

GROUP ASSEMBLY PARTS LIST

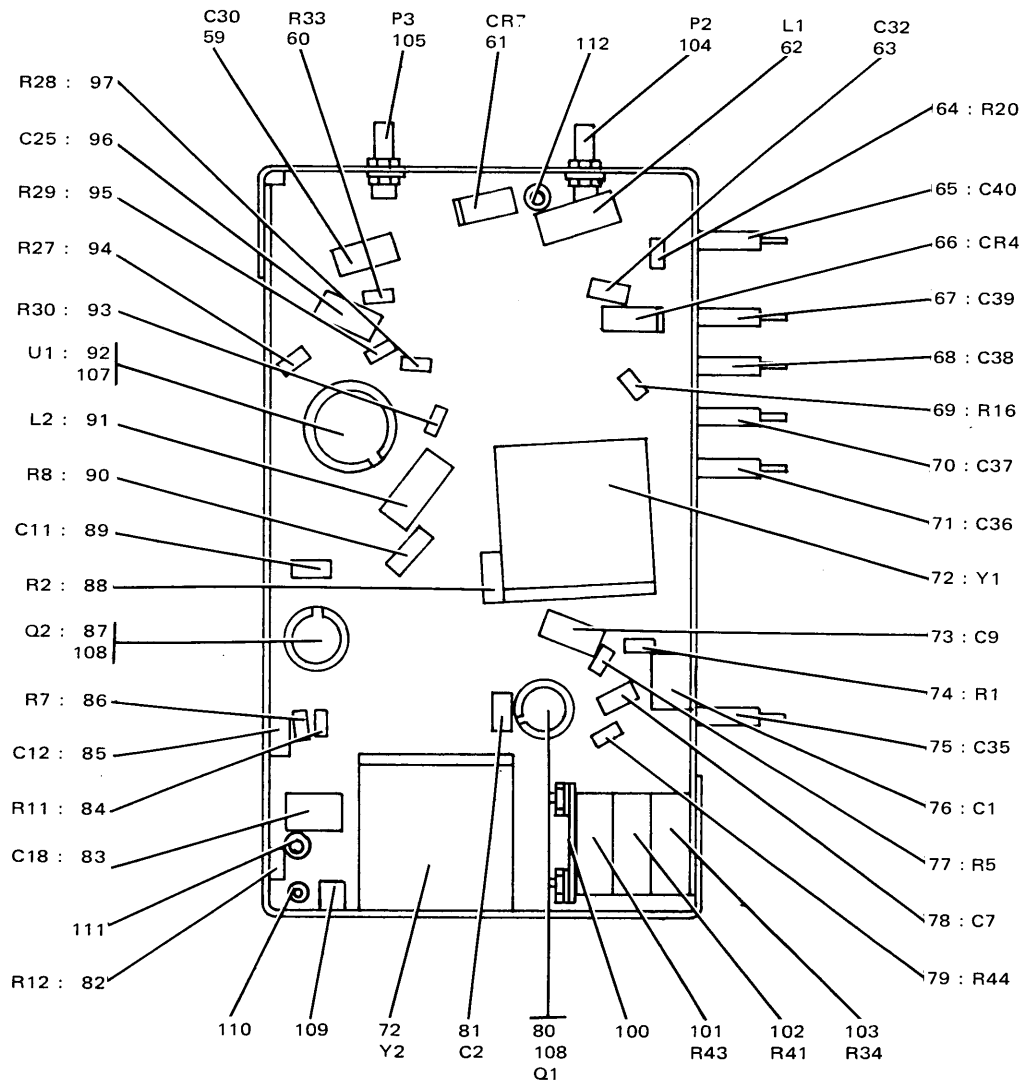

TP3-2239-029

Variable Beat Frequency Oscillator Assembly (A2A1) 618-7705-001, -002  
Figure 33 (Sheet 2 of 2)

## GROUP ASSEMBLY PARTS LIST

FIG - ITEM	PART NO	INDENT	DESCRIPTION	USABLE ON CODE	UNITS PER ASSY
33 -	618-7705-001	1	OSCILLATOR ASSY, VARIABLE BEAT FREQUENCY A2A1 (SEE FIG 23-1 FOR NHA)	AH	RF
	618-7705-002	1	OSCILLATOR ASSY, VARIABLE BEAT FREQUENCY A2A1 (SEE FIG 23-1 FOR NHA)	AJ	RF
1	618-7703-001 MS51957-3	2	COVER		1
		2	SCREW, MACH, CD PL STL, 2-56 X 1/4 (V96906) 343-0124-000 (AP)		4
2	2N2222A	2	TRANSISTOR, (V07688) 352-0661-020 A2A1Q5		1
3	RCR05G103K	2	RESISTOR, FXD, CMPSN, 10K, 10%, 1/8W (V81349) 745-2377-000 A2A1R19		1
4	8131-050-651-104 M	2	CAPACITOR, FXD, CER DIEI, 0.1UF, 20%, 50V (V72982) 913-3279-200 A2A1C20		1
5	RCR05G221K	2	RESISTOR, FXD, CMPSN, 220 OHMS, 10%, 1/8W (V81349) 745-2317-000 A2A1R45		1
6	RCR05G103K	2	RESISTOR, FXD, CMPSN, 10K, 10%, 1/8W (V81349) 745-2377-000 A2A1R17		1
7	1N914	2	SEMICOND DEVICE, (V07688) 353-2906-000 A2A1CR8		1
8	RCR05G561K	2	RESISTOR, FXD, CMPSN, 560 OHMS, 10%, 1/8W (V81349) 745-2332-000 A2A1R22		1
9	RCR05G561K	2	RESISTOR, FXD, CMPSN, 560 OHMS, 10%, 1/8W (V81349) 745-2332-000 A2A1R21		1
10	8131-050-651-104 M	2	CAPACITOR, FXD, CER DIEI, 0.1UF, 20%, 50V (V72982) 913-3279-200 A2A1C19		1
11	8131-050-651-104 M	2	CAPACITOR, FXD, CER DIEI, 0.1UF, 20%, 50V (V72982) 913-3279-200 A2A1C21		1
11A	DM5F181J050WV	2	CAPACITOR, FXD, MICA DIEI, 180PF, 5%, 50V (V72136) 912-4141-430 A2A1C46 (EFF CI 72464)		1
12	2N2222A	2	TRANSISTOR, (V07688) 352-0661-020 A2A1Q4		1
13	2N2222A	2	TRANSISTOR, (V07688) 352-0661-020 A2A1Q6		1
14	MS90537-48	2	COIL, RF, 820UH (V96906) 240-2715-480 A2A1L7		1
15	RCR05G153K	2	RESISTOR, FXD, CMPSN, 15K, 10%, 1/8W (V81349) 745-2383-000 A2A1R31		1
16	2C067103X0101A3	2	CAPACITOR, FXD, CER DIEI, 0.01UF, 20%, 100V (V56289) 913-4240-100 A2A1C27		1
17	2C067103X0101A3	2	CAPACITOR, FXD, CER DIEI, 0.01UF, 20%, 100V (V56289) 913-4240-100 A2A1C22		1
18	RCR05G561K	2	RESISTOR, FXD, CMPSN, 560 OHMS, 10%, 1/8W (V81349) 745-2332-000 A2A1R32		AR
18	RCR05G122K	2	RESISTOR, FXD, CMPSN, 1.2K, 10%, 1/8W (V81349) 745-2344-000 A2A1R32		AR
18	RCR05G152K	2	RESISTOR, FXD, CMPSN, 1.5K, 10%, 1/8W (V81349) 745-2347-000 A2A1R32		AR
18	RCR05G182K	2	RESISTOR, FXD, CMPSN, 1.8K, 10%, 1/8W (V81349) 745-2350-000 A2A1R32		AR
18	RCR05G222K	2	RESISTOR, FXD, CMPSN, 2.2K, 10%, 1/8W (V81349) 745-2353-000 A2A1R32		AR
18	RCR05G272K	2	RESISTOR, FXD, CMPSN, 2.7K, 10%, 1/8W (V81349) 745-2356-000 A2A1R32		AR
18	RCR05G332K	2	RESISTOR, FXD, CMPSN, 3.3K, 10%, 1/8W (V81349) 745-2359-000 A2A1R32		AR
18	RCR05G392K	2	RESISTOR, FXD, CMPSN, 3.9K, 10%, 1/8W (V81349) 745-2362-000 A2A1R32		AR
18	RCR05G472K	2	RESISTOR, FXD, CMPSN, 4.7K, 10%, 1/8W (V81349) 745-2365-000 A2A1R32		AR
18	RCR05G562K	2	RESISTOR, FXD, CMPSN, 5.6K, 10%, 1/8W (V81349) 745-2368-000 A2A1R32		AR
18	RCR05G682K	2	RESISTOR, FXD, CMPSN, 6.8K, 10%, 1/8W (V81349) 745-2371-000 A2A1R32		AR
19	RCR05G102K	2	RESISTOR, FXD, CMPSN, 1K, 10%, 1/8W (V81349) 745-2341-000 A2A1R23		1
20	RCR05G680K	2	RESISTOR, FXD, CMPSN, 68 OHMS, 10%, 1/8W (V81349) 745-2298-000 A2A1R39		1
21	MS75085-11	2	COIL, RF, 220UH (V96906) 240-2723-060 A2A1L5		1

GROUP ASSEMBLY PARTS LIST

FIG - ITEM	PART NO	INDENT	DESCRIPTION	USABLE ON CODE	UNITS PER ASSY
33	22	8131-050-651-104	2 CAPACITOR,FXD, CER DIEL, 0.1UF, 20%, 50V (V72982) 913-3279-200 A2A1C29		1
	M				
	23	RCR05G222K	2 RESISTOR,FXD, CMPSN, 2.2K, 10%, 1/8W (V81349) 745-2353-000 A2A1R26		1
	24	8131-050-651-104	2 CAPACITOR,FXD, CER DIEL, 0.1UF, 20%, 50V (V72982) 913-3279-200 A2A1C23		1
	M				
	25	MS75085-11	2 COIL,RF, 220UH (V96906) 240-2723-060 A2A1L6		1
	26	DM5F401J050WV	2 CAPACITOR,FXD, MICA DIEL, 400PF, 5%, 50V (V72136) 912-4141-520 A2A1C10		1
	27	RCR05G472K	2 RESISTOR,FXD, CMPSN, 4.7K, 10%, 1/8W (V81349) 745-2365-000 A2A1R24		1
	28	RCR05G103K	2 RESISTOR,FXD, CMPSN, 10K, 10%, 1/8W (V81349) 745-2377-000 A2A1R25		1
	29	RCR05G474K	2 RESISTOR,FXD, CMPSN, 470K, 10%, 1/8W (V81349) 745-2437-000 A2A1R10		1
	30	MV1404	2 SEMICOND DEVICE, (V04713) 922-6100-020 A2A1CR3		1
	31	RCR05G474K	2 RESISTOR,FXD, CMPSN, 470K, 10%, 1/8W (V81349) 745-2437-000 A2A1R9		1
	32	DM5E240D050WV	2 CAPACITOR,FXD, MICA DIEL, 24PF, 0.5PF, 50V (V72136) 912-4141-160 A2A1C16		1
	33	DM5E200D050WV	2 CAPACITOR,FXD, MICA DIEL, 20PF, 0.5PF, 50V (V72136) 912-4141-150 A2A1C13		AR
	33	TC20-110	2 CAPACITOR,FXD, CER DIEL, 20PF, 1PF, 500V (V09052) 913-0052-000 A2A1C13		AR
	33	TC20-92	2 CAPACITOR,FXD, CER DIEL, 20PF, 1PF, 500V (V09052) 913-0053-000 A2A1C13		AR
	33	TC20-89	2 CAPACITOR,FXD, CER DIEL, 20PF, 1PF, 500V (V09052) 913-0054-000 A2A1C13		AR
	33	TC20-90	2 CAPACITOR,FXD, CER DIEL, 20PF, 1PF, 500V (V09052) 913-0055-000 A2A1C13		AR
	33	TC20-82	2 CAPACITOR,FXD, CER DIEL, 20PF, 1PF, 500V (V09052) 913-0056-000 A2A1C13		AR
	33	TC20-81	2 CAPACITOR,FXD, CER DIEL, 20PF, 1PF, 500V (V09052) 913-0057-000 A2A1C13		AR
	33	TC20-94	2 CAPACITOR,FXD, CER DIEL, 20PF, 1PF, 500V (V09052) 913-0058-000 A2A1C13		AR
	33	DA934-023	2 CAPACITOR,FXD, CER DIEL, 20PF, 2PF, 500V (V71590) 913-0232-000 A2A1C13		AR
	33	DA934-024	2 CAPACITOR,FXD, CER DIEL, 20PF, 2PF, 500V (V71590) 913-0233-000 A2A1C13		AR
	33	DA934-025	2 CAPACITOR,FXD, CER DIEL, 20PF, 2PF, 500V (V71590) 913-0234-000 A2A1C13		AR
	34	2C067103X0101A3	2 CAPACITOR,FXD, CER DIEL, 0.01UF, 20%, 100V (V56289) 913-4240-100 A2A1C15		1
	35	DM5F401J050WV	2 CAPACITOR,FXD, MICA DIEL, 400PF, 5%, 50V (V72136) 912-4141-520 A2A1C17		1
	36	DM5F271J050WV	2 CAPACITOR,FXD, MICA DIEL, 270PF, 5%, 50V (V72136) 912-4141-470 A2A1C8		1
	37	DM5F201J050WV	2 CAPACITOR,FXD, MICA DIEL, 200PF, 5%, 50V (V72136) 912-4141-440 A2A1C45		1
	38	DM5E200D050WV	2 CAPACITOR,FXD, MICA DIEL, 20PF, 0.5PF, 50V (V72136) 912-4141-150 A2A1C3		AR
	38	DM5E240D050WV	2 CAPACITOR,FXD, MICA DIEL, 24PF, 0.5PF, 50V (V72136) 912-4141-160 A2A1C3		AR
	38	DM5E270J050WV	2 CAPACITOR,FXD, MICA DIEL, 27PF, 5%, 50V (V72136) 912-4141-180 A2A1C3		AR
	38	DM5E300J050WV	2 CAPACITOR,FXD, MICA DIEL, 30PF, 5%, 50V (V72136) 912-4141-200 A2A1C3		AR
	38	DM5E330J050WV	2 CAPACITOR,FXD, MICA DIEL, 33PF, 5%, 50V (V72136) 912-4141-220 A2A1C3		AR
	38	DM5E360J050WV	2 CAPACITOR,FXD, MICA DIEL, 36PF, 5%, 50V (V72136) 912-4141-240 A2A1C3		AR

## GROUP ASSEMBLY PARTS LIST

FIG - ITEM	PART NO	INDENT	DESCRIPTION	USABLE ON CODE	UNITS PER ASSY
33	38		2 CAPACITOR,FXD, MICA DIEI, 43PF, 5%, 50V (V72136)		AR
			912-4141-260 A2A1C3		
	39		2 RESISTOR,FXD, CMPSN, 15K, 5%, 1/8W (V81349)		1
			745-1863-770 A2A1R6		
	40		2 RESISTOR,FXD, CMPSN, 56K, 10%, 1/8W (V81349)		1
			745-2404-000 A2A1R40		
	41		2 RESISTOR,FXD, CMPSN, 33K, 10%, 1/8W (V81349)		1
			745-2395-000 A2A1R35		
	42		2 RESISTOR,FXD, CMPSN, 10K, 10%, 1/8W (V81349)		1
			745-2377-000 A2A1R42		
	43		2 RESISTOR,FXD, CMPSN, 470K, 10%, 1/8W (V81349)		1
			745-2437-000 A2A1R3		
	44		2 CAPACITOR,FXD, CER DIEI, 0.01UF, 20%, 100V		1
			(V56289) 913-4240-100 A2A1C4		
	45		2 RESISTOR,FXD, CMPSN, 470K, 10%, 1/8W (V81349)		1
			745-2437-000 A2A1R4		
	46		2 SEMICOND DEVICE, (V04713) 922-6100-020 A2A1CR1		1
	47		2 CAPACITOR,FXD, MICA DIEI, 20PF, 0.5PF, 50V		AR
			(V72136) 912-4141-150 A2A1C5		
	47		2 CAPACITOR,FXD, CER DIEI, 20PF, 1PF, 500V		AR
			(V09052) 913-0052-000 A2A1C5		
	47		2 CAPACITOR,FXD, CER DIEI, 20PF, 1PF, 500V		AR
			(V09052) 913-0053-000 A2A1C5		
	47		2 CAPACITOR,FXD, CER DIEI, 20PF, 1PF, 500V		AR
			(V09052) 913-0054-000 A2A1C5		
	47		2 CAPACITOR,FXD, CER DIEI, 20PF, 1PF, 500V		AR
			(V09052) 913-0055-000 A2A1C5		
	47		2 CAPACITOR,FXD, CER DIEI, 20PF, 1PF, 500V		AR
			(V09052) 913-0056-000 A2A1C5		
	47		2 CAPACITOR,FXD, CER DIEI, 20PF, 1PF, 500V		AR
			(V09052) 913-0057-000 A2A1C5		
	47		2 CAPACITOR,FXD, CER DIEI, 20PF, 1PF, 500V		AR
			(V09052) 913-0058-000 A2A1C5		
	47		2 CAPACITOR,FXD, CER DIEI, 20PF, 2PF, 500V		AR
			(V71590) 913-0232-000 A2A1C5		
	47		2 CAPACITOR,FXD, CER DIEI, 20PF, 2PF, 500V		AR
			(V71590) 913-0233-000 A2A1C5		
	47		2 CAPACITOR,FXD, CER DIEI, 20PF, 2PF, 500V		AR
			(V71590) 913-0234-000 A2A1C5		
	48		2 CAPACITOR,FXD, CER DIEI, 0.01UF, 20%, 100V		1
			(V56289) 913-4240-100 A2A1C33		
	49		2 CAPACITOR,FXD, CER DIEI, 0.01UF, 20%, 100V		1
			(V56289) 913-4240-100 A2A1C24		
	50		2 COIL,RF, 220UH (V96906) 240-2715-410 A2A1L3		1
	51		2 SEMICOND DEVICE, (V07688) 353-2906-000 A2A1CR5		1
	52		2 SEMICOND DEVICE, (V07688) 353-2906-000 A2A1CR6		1
	53		2 RESISTOR,FXD, CMPSN, 10K, 10%, 1/8W (V81349)		1
			745-2377-000 A2A1R13		
	54		2 TRANSISTOR, (V07688) 352-0661-020 A2A1Q3		1
	55		2 RESISTOR,FXD, CMPSN, 10K, 10%, 1/8W (V81349)		1
			745-2377-000 A2A1R14		
	56		2 RESISTOR,FXD, CMPSN, 2.2K, 10%, 1/8W (V81349)		1
			745-2353-000 A2A1R18		
	57		2 COIL,RF, 220UH (V96906) 240-2715-410 A2A1L4		1
	58		2 RESISTOR,FXD, CMPSN, 2.2K, 10%, 1/8W (V81349)		1
			745-2353-000 A2A1R15		
	59		2 CAPACITOR,FXD, MICA DIEI, 180PF, 5%, 50V		1
			(V72136) 912-4141-430 A2A1C30		
	60		2 RESISTOR,FXD, CMPSN, 12K, 10%, 1/8W (V81349)		1
			745-2380-000 A2A1R33		
	61		2 SEMICOND DEVICE, (V07688) 353-2906-000 A2A1CR7		1
	62		2 COIL,RF, 8200UH (V96906) 240-2715-600 A2A1L1		1

GROUP ASSEMBLY PARTS LIST

FIG - ITEM	PART NO	INDENT	DESCRIPTION	USABLE ON CODE	UNITS PER ASSY
33	63	2C067103X0101A3	2 CAPACITOR,FXD, CER DIEL, 0.01UF, 20%, 100V (V56289) 913-4240-100 A2A1C32		1
	64	RCR05G102K	2 RESISTOR,FXD, CMPSN, 1K, 10%, 1/8W (V81349) 745-2341-000 A2A1R20		1
	65	1251-003	2 FILTER,RAD INTR, (V72982) 241-5010-010 A2A1C40		1
	66	1N914	2 SEMICOND DEVICE, (V07688) 353-2906-000 A2A1CR4		1
	67	1251-003	2 FILTER,RAD INTR, (V72982) 241-5010-010 A2A1C39		1
	68	1251-003	2 FILTER,RAD INTR, (V72982) 241-5010-010 A2A1C38		1
	69	RCR05G222K	2 RESISTOR,FXD, CMPSN, 2.2K, 10%, 1/8W (V81349) 745-2353-000 A2A1R16		1
	70	1251-003	2 FILTER,RAD INTR, (V72982) 241-5010-010 A2A1C37		1
	71	1251-003	2 FILTER,RAD INTR, (V72982) 241-5010-010 A2A1C36		1
	72	289-7179-010M70	2 XTAL UNIT SET, (V75378) 289-7179-010 A2A1Y1,Y2 (MATCHED SET)	AH	1
	72	289-7179-020M70	2 XTAL UNIT,QTZ, 4MHZ + 4.4555MHZ (V75378) 289-7179-020 A2A1Y1,Y2 (MATCHED SET)	AJ	1
	73	DM5F101J050WV	2 CAPACITOR,FXD, MICA DIEL, 100PF, 5%, 50V (V72136) 912-4141-050 A2A1C9		1
	74	RCR05G472JS	2 RESISTOR,FXD, CMPSN, 4.7K, 5%, 1/8W (V81349) 745-1863-650 A2A1R1		1
	75	1251-003	2 FILTER,RAD INTR, (V72982) 241-5010-010 A2A1C35		1
	76	DM5F361J050WV	2 CAPACITOR,FXD, MICA DIEL, 360PF, 5%, 50V (V72136) 912-4141-500 A2A1C1		1
	77	RCR05G133JS	2 RESISTOR,FXD, CMPSN, 13K, 5%, 1/8W (V81349) 745-1863-760 A2A1R5		1
	78	2C067103X0101A3	2 CAPACITOR,FXD, CER DIEL, 0.01UF, 20%, 100V (V56289) 913-4240-100 A2A1C7		1
	79	RCR05G102K	2 RESISTOR,FXD, CMPSN, 1K, 10%, 1/8W (V81349) 745-2341-000 A2A1R44		1
	80	S29119	2 TRANSISTOR, (V07263) 352-0440-030 A2A1Q1		1
	81	2C067103X0101A3	2 CAPACITOR,FXD, CER DIEL, 0.01UF, 20%, 100V (V56289) 913-4240-100 A2A1C2		1
	82	RCR05G153JS	2 RESISTOR,FXD, CMPSN, 15K, 5%, 1/8W (V81349) 745-1863-770 A2A1R12		1
	83	DM5F361J050WV	2 CAPACITOR,FXD, MICA DIEL, 360PF, 5%, 50V (V72136) 912-4141-500 A2A1C18		1
	84	RCR05G133JS	2 RESISTOR,FXD, CMPSN, 13K, 5%, 1/8W (V81349) 745-1863-760 A2A1R11		1
	85	2C067103X0101A3	2 CAPACITOR,FXD, CER DIEL, 0.01UF, 20%, 100V (V56289) 913-4240-100 A2A1C12		1
	86	RCR05G472JS	2 RESISTOR,FXD, CMPSN, 4.7K, 5%, 1/8W (V81349) 745-1863-650 A2A1R7		1
	87	S29119	2 TRANSISTOR, (V07263) 352-0440-030 A2A1Q2		1
	88	T055-5-11K1F	2 RESISTOR,FXD, FILM, 5.11K, 1%, 1/8W (V11502) 705-1454-560 A2A1R2		1
	89	2C067103X0101A3	2 CAPACITOR,FXD, CER DIEL, 0.01UF, 20%, 100V (V56289) 913-4240-100 A2A1C11		1
	90	T055-5-11K1F	2 RESISTOR,FXD, FILM, 5.11K, 1%, 1/8W (V11502) 705-1454-560 A2A1R8		1
	91	MS90537-41	2 COIL,RF, 220UH (V96906) 240-2715-410 A2A1L2		1
	92	MC1596G	2 INTEGRATED CKT, (V04713) 351-0043-010 A2A1U1		1
	93	RCR05G392K	2 RESISTOR,FXD, CMPSN, 3.9K, 10%, 1/8W (V81349) 745-2362-000 A2A1R30		1
	94	RCR05G682K	2 RESISTOR,FXD, CMPSN, 6.8K, 10%, 1/8W (V81349) 745-2371-000 A2A1R27		1
	95	RCR05G392K	2 RESISTOR,FXD, CMPSN, 3.9K, 10%, 1/8W (V81349) 745-2362-000 A2A1R29		1
	96	8131-050-651-104 M	2 CAPACITOR,FXD, CER DIEL, 0.1UF, 20%, 50V (V72982) 913-3279-200 A2A1C25		1
	97	RCR05G102K	2 RESISTOR,FXD, CMPSN, 1K, 10%, 1/8W (V81349) 745-2341-000 A2A1R28		1
	98	M5757-9-027	2 RELAY,ARM, (V81349) 974-1076-130 A2A1K1		1

GROUP ASSEMBLY PARTS LIST

FIG - ITEM	PART NO	INDENT	DESCRIPTION	USABLE ON CODE	UNITS PER ASSY
33	P313-0132-000	2	NUT, PLAIN, HEX, SST, 4-40 (V77250) 313-0132-000 (AP FOR 98,99)		4
	310-0278-000	2	WASHER, LOCK, SST, 0.115 ID X 0.202 OD (V70318) 310-0278-000 (AP FOR 98,99)		4
	310-0057-000	2	WASHER, FLAT, BRN, 0.172 ID X 0.375 OD (V79807) 310-0057-000 (AP) (EFF CI 72434)		4
	MS51959-12	2	SCREW, MACH, SST, 4-40 X 3/16 (V96906) 342-0043-000 (EFF TO CI 72434)		4
	P330-2290-000	2	SCREW, MACH, SST, 4-40 X 1/4 (V77250) 330-2290-000 (AP) (EFF CI 72434)		4
100	H25	2	MTG HARDWARE, (V80294) 381-1446-000		1
	MS35649-224	2	NUT, PLAIN, HEX, SST, 2-56 (V96906) 313-0037-000 (AP)		2
	310-0070-000	2	WASHER, LOCK, SST, 0.097 ID X 0.165 OD (V79807) 310-0070-000 (AP)		2
	MS51957-9	2	SCREW, MACH, SST, 2-56 X 3/4 (V96906) 343-0129-000 (AP)		2
101	RT22C2L502	2	RESISTOR, VAR, WW, 5K, 5%, 3/4W (V81349) 381-1721-120 A2A1R43		1
102	RT22C2L203	2	RESISTOR, VAR, 20K, 5%, 3/4W (V81349) 381-1721-160 A2A1R41		1
103	RT22C2L203	2	RESISTOR, VAR, 20K, 5%, 3/4W (V81349) 381-1721-160 A2A1R34		1
104	141-1002-0002	2	CONNECTOR, RCPT, ELEC (V98278) 357-7353-010 A2A1P2		1
105	141-1002-0002	2	CONNECTOR, RCPT, ELEC (V98278) 357-7353-010 A2A1P3		1
	302-4800-000	2	WASHER, NM, FBR, 0.115 ID X 1/4 OD (V74921) 302-4800-000 (AP FOR 104,105)		2
106	618-7704-001	2	CHASSIS ASSY		1
107	T1532	3	HOLDER, XSTR, (V98291) 352-9508-000		1
108	T1533	3	HOLDER, XSTR, (V98291) 352-9509-000		6
109	609-1558-001	3	NUT, ANCHOR		10
110	SS5170	3	TERMINAL, FEEDTH, (V86577) 306-0989-000		10
111	SL441-434WHT	3	TERMINAL, STUD, (V12615) 306-2222-100		26
112	SL354-351WHT	3	TERMINAL, FEEDTH, (V12615) 306-2474-010		29
113	618-7702-001	3	CHASSIS		1
34 -	608-9087-001	1	CIRCUIT CARD ASSY, DECODER/DRIVER A7 (SEE FIG 1-17 FOR NHA)	AC, AD, AE AF, AR, AS AT, AU, AV AX	RF
	1 RCR07G473KS	2	RESISTOR, FXD, CMPSN, 47K, 10%, 1/4W (V81349) 745-0809-000 A7R3		1
	2 RCR07G223KS	2	RESISTOR, FXD, CMPSN, 22K, 10%, 1/4W (V81349) 745-0797-000 A7R2		1
	3 2N2222A	2	TRANSISTOR, (V07688) 352-0661-020 A7Q1		1
	4 RCR07G103KS	2	RESISTOR, FXD, CMPSN, 10K, 10%, 1/4W (V81349) 745-0785-000 A7R1		1
	5 MC7420P	2	INTEGRATED CKT, (V04713) 351-7636-010 A7U3		1
	6 MC7404P	2	INTEGRATED CKT, (V04713) 351-7630-010 A7U2		1
	6A 1N459	2	SEMICOND DEVICE, (V07688) 353-0206-000 A7CR6 (EFF CI 72516)		1
	7 RCR07G102KS	2	RESISTOR, FXD, CMPSN, 1K, 10%, 1/4W (V81349) 745-0749-000 A7R4		1
	8 2N2907A	2	TRANSISTOR, (V07688) 352-0551-010 A7Q2		1
	9 RCR07G473KS	2	RESISTOR, FXD, CMPSN, 47K, 10%, 1/4W (V81349) 745-0809-000 A7R6		1

GROUP ASSEMBLY PARTS LIST

FIG - ITEM	PART NO	INDENT	DESCRIPTION	USABLE ON CODE	UNITS PER ASSY
34 10	RCR07G102KS	2	RESISTOR,FXD, CMPSN, 1K, 10%, 1/4W (V81349) 745-0749-000 A7R10		1
11	2N2907A	2	TRANSISTOR, (V07688) 352-0551-010 A7Q4		1
12	RCR07G473KS	2	RESISTOR,FXD, CMPSN, 47K, 10%, 1/4W (V81349) 745-0809-000 A7R12		1
13	RCR07G102KS	2	RESISTOR,FXD, CMPSN, 1K, 10%, 1/4W (V81349) 745-0749-000 A7R7		1
14	2N2907A	2	TRANSISTOR, (V07688) 352-0551-010 A7Q3		1
15	RCR07G473KS	2	RESISTOR,FXD, CMPSN, 47K, 10%, 1/4W (V81349) 745-0809-000 A7R9		1
16	RCR07G152KS	2	RESISTOR,FXD, CMPSN, 1.5K, 10%, 1/4W (V81349) 745-0755-000 A7R8		1
17	2C067103X0101A3	2	CAPACITOR,FXD, CER NIEL, 0.01UF, 20%, 100V (V56289) 913-4240-100 A7C4		1
18	8131-050-651-104 M	2	CAPACITOR,FXD, CER NIEL, 0.1UF, 20%, 50V (V72982) 913-3279-200 A7C1		1
19	RCR07G152KS	2	RESISTOR,FXD, CMPSN, 1.5K, 10%, 1/4W (V81349) 745-0755-000 A7R11		1
20	2C067103X0101A3	2	CAPACITOR,FXD, CER NIEL, 0.01UF, 20%, 100V (V56289) 913-4240-100 A7C5		1
21	8131-050-651-104 M	2	CAPACITOR,FXD, CER NIEL, 0.1UF, 20%, 50V (V72982) 913-3279-200 A7C2		1
22	RCR07G152KS	2	RESISTOR,FXD, CMPSN, 1.5K, 10%, 1/4W (V81349) 745-0755-000 A7R5		1
23	2C067103X0101A3	2	CAPACITOR,FXD, CER NIEL, 0.01UF, 20%, 100V (V56289) 913-4240-100 A7C3		1

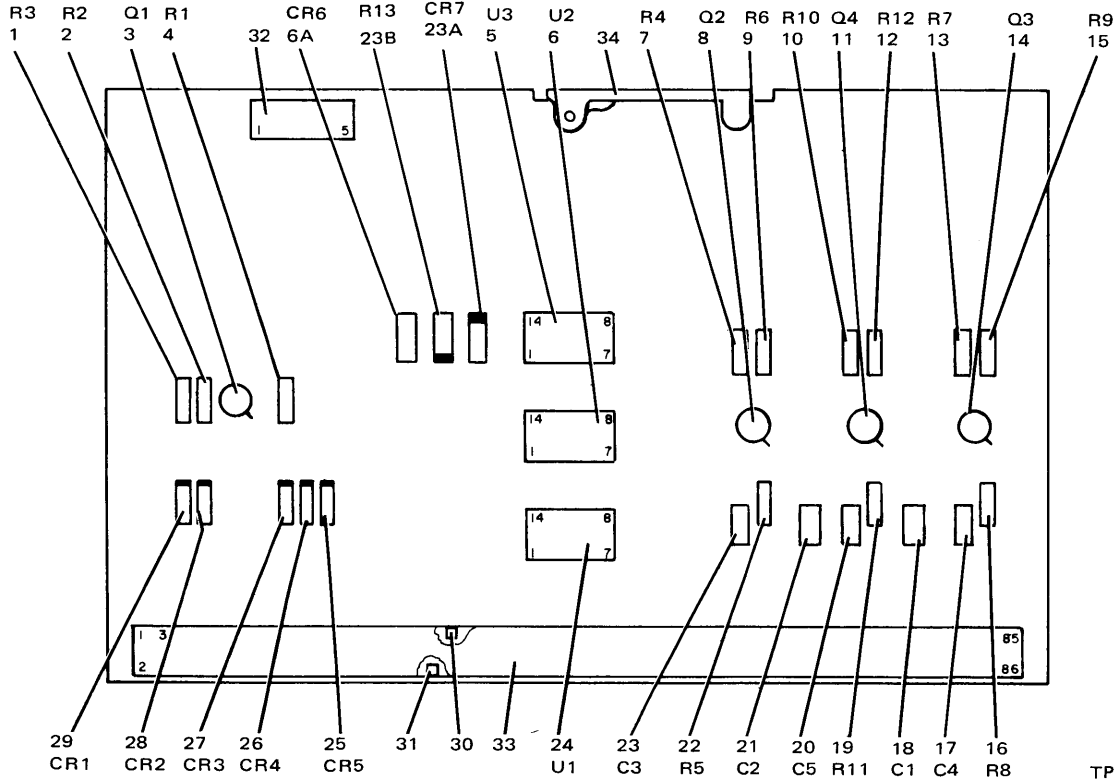

TP3-2238-019

Decoder/Driver Circuit Card Assembly (A7) 608-9087-001  
Figure 34



GROUP ASSEMBLY PARTS LIST

FIG - ITEM	PART NO	INDENT	DESCRIPTION	USABLE ON CODE	UNITS PER ASSY
34	23A 1N459	2	SEMICONV DEVICE, (V07688) 353-0206-000 A7CR6 (EFF CI 72516)		1
	23B RCR07G103KS	2	RESISTOR, FXD, CMPSN, 10K, 10%, 1/4W (V81349) 745-0785-000 A7R13 (EFF CI 72516)		1
	24 MC7400P	2	INTEGRATED CKT, (V04713) 351-7629-010 A7U1		1
	25 1N459	2	SEMICONV DEVICE, (V07688) 353-0206-000 A7CR4		1
	26 1N459	2	SEMICONV DEVICE, (V07688) 353-0206-000 A7CR5		1
	27 1N459	2	SEMICONV DEVICE, (V07688) 353-0206-000 A7CR3		1
	28 1N459	2	SEMICONV DEVICE, (V07688) 353-0206-000 A7CR2		1
	29 1N459	2	SEMICONV DEVICE, (V07688) 353-0206-000 A7CR1		1
	30 372-2234-020	2	CONTACT, ELEC, (V13499) 372-2234-020		20
	31 372-2234-010	2	CONTACT, ELEC, (V13499) 372-2234-010		15
	32 372-2621-014	2	HOUSING, CONN, 372-2621-014		1
	33 372-2623-052	2	HOUSING, CONN, EL, 372-2623-052		1
	34 608-9158-001	2	HANDLE		1
	MS16562-199	2	PIN, SPR, SST, 0.078 DIA X 1/4 (V96906) 311-0355-000 (AP)		1
35 -	608-9121-001	1	CIRCUIT CARD ASSY, DECODER/DRIVER A7 (SEE FIG 1-17 FOR NHA)	N AG, AW	RF
	1 1N459	2	SEMICONV DEVICE, (V07688) 353-0206-000 A7CR1		1

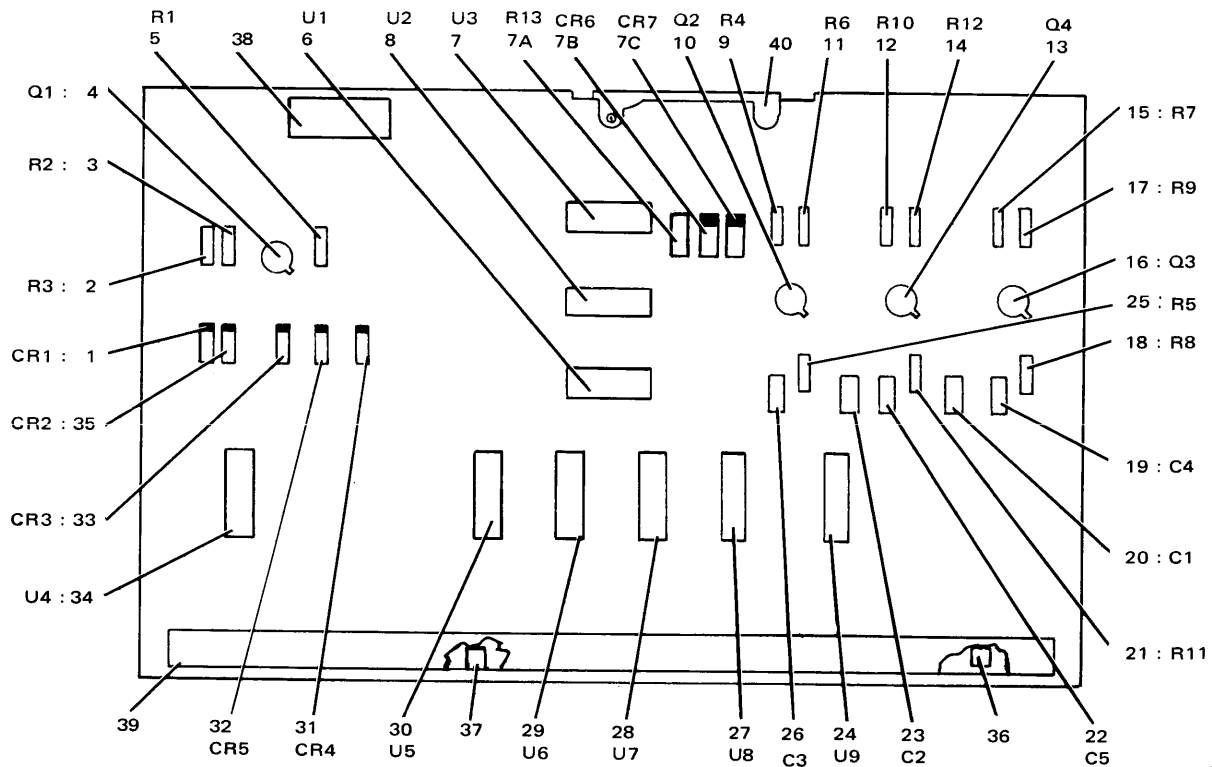

TP3-2237-019

Decoder/Driver Circuit Card Assembly (A7) 608-9121-001  
Figure 35

## GROUP ASSEMBLY PARTS LIST

FIG - ITEM	PART NO	INDENT	DESCRIPTION	USABLE ON CODE	UNITS PER ASSY
35	2 RCR07G473KS	2	RESISTOR,FXD, CMPSN, 47K, 10%, 1/4W (V81349) 745-0809-000 A7R3		1
	3 RCR07G223KS	2	RESISTOR,FXD, CMPSN, 22K, 10%, 1/4W (V81349) 745-0797-000 A7R2		1
	4 2N2222A	2	TRANSISTOR, (V07688) 352-0661-020 A7Q1		1
	5 RCR07G103KS	2	RESISTOR,FXD, CMPSN, 10K, 10%, 1/4W (V81349) 745-0785-000 A7R1		1
	6 MC7400P	2	INTEGRATED CKT, (V04713) 351-7629-010 A7U1		1
	7 MC7420P	2	INTEGRATED CKT, (V04713) 351-7636-010 A7U3		1
	7A RCR07G103KS	2	RESISTOR,FXD, CMPSN, 10K, 10%, 1/4W (V81349) 745-0785-000 A7R13		1
	7B 1N459	2	SEMICOND DEVICE, (V07688) 353-0206-000 A7CR6		1
	7C 1N459	2	SEMICOND DEVICE, (V07688) 353-0206-000 A7CR7		1
	8 MC7404P	2	INTEGRATED CKT, (V04713) 351-7630-010 A7U2		1
	9 RCR07G102KS	2	RESISTOR,FXD, CMPSN, 1K, 10%, 1/4W (V81349) 745-0749-000 A7R4		1
	10 2N2907A	2	TRANSISTOR, (V07688) 352-0551-010 A7Q2		1
	11 RCR07G473KS	2	RESISTOR,FXD, CMPSN, 47K, 10%, 1/4W (V81349) 745-0809-000 A7R6		1
	12 RCR07G102KS	2	RESISTOR,FXD, CMPSN, 1K, 10%, 1/4W (V81349) 745-0749-000 A7R10		1
	13 2N2907A	2	TRANSISTOR, (V07688) 352-0551-010 A7Q4		1
	14 RCR07G473KS	2	RESISTOR,FXD, CMPSN, 47K, 10%, 1/4W (V81349) 745-0809-000 A7R12		1
	15 RCR07G102KS	2	RESISTOR,FXD, CMPSN, 1K, 10%, 1/4W (V81349) 745-0749-000 A7R7		1
	16 2N2907A	2	TRANSISTOR, (V07688) 352-0551-010 A7Q3		1
	17 RCR07G473KS	2	RESISTOR,FXD, CMPSN, 47K, 10%, 1/4W (V81349) 745-0809-000 A7R9		1
	18 RCR07G152KS	2	RESISTOR,FXD, CMPSN, 1.5K, 10%, 1/4W (V81349) 745-0755-000 A7R8		1
	19 2C067103X0101A3	2	CAPACITOR,FXD, CER DIEL, 0.01UF, 20%, 100V (V56289) 913-4240-100 A7C4		1
	20 8131-050-651-104 M	2	CAPACITOR,FXD, CER DIEL, 0.1UF, 20%, 50V (V72982) 913-3279-200 A7C1		1
	21 RCR07G152KS	2	RESISTOR,FXD, CMPSN, 1.5K, 10%, 1/4W (V81349) 745-0755-000 A7R11		1
	22 2C067103X0101A3	2	CAPACITOR,FXD, CER DIEL, 0.01UF, 20%, 100V (V56289) 913-4240-100 A7C5		1
	23 8131-050-651-104 M	2	CAPACITOR,FXD, CER DIEL, 0.1UF, 20%, 50V (V72982) 913-3279-200 A7C2		1
	24 MC7404P	2	INTEGRATED CKT, (V04713) 351-7630-010 A7U9		1
	25 RCR07G152KS	2	RESISTOR,FXD, CMPSN, 1.5K, 10%, 1/4W (V81349) 745-0755-000 A7R5		1
	26 2C067103X0101A3	2	CAPACITOR,FXD, CER DIEL, 0.01UF, 20%, 100V (V56289) 913-4240-100 A7C3		1
	27 MC7404P	2	INTEGRATED CKT, (V04713) 351-7630-010 A7U8		1
	28 MC7404P	2	INTEGRATED CKT, (V04713) 351-7630-010 A7U7		1
	29 MC7404P	2	INTEGRATED CKT, (V04713) 351-7630-010 A7U6		1
	30 MC7404P	2	INTEGRATED CKT, (V04713) 351-7630-010 A7U5		1
	31 1N459	2	SEMICOND DEVICE, (V07688) 353-0206-000 A7CR4		1
	32 1N459	2	SEMICOND DEVICE, (V07688) 353-0206-000 A7CR5		1
	33 1N459	2	SEMICOND DEVICE, (V07688) 353-0206-000 A7CR3		1
	34 MC7404P	2	INTEGRATED CKT, (V04713) 351-7630-010 A7U4		1
	35 1N459	2	SEMICOND DEVICE, (V07688) 353-0206-000 A7CR2		1
	36 372-2234-020	2	CONTACT,ELEC, (V13499) 372-2234-020		25
	37 372-2234-010	2	CONTACT,ELEC, (V13499) 372-2234-010		32
	38 372-2621-014	2	HOUSING,CONN, 372-2621-014		1
	39 372-2623-052	2	HOUSING,CONN,EL, 372-2623-052		1
	40 608-9158-001	2	HANDLE		1
	MS16562-199	2	PIN,SPR, SST, 0.078 DIA X 1/4 (V96906) 311-0355-000 (AP)		1

GROUP ASSEMBLY PARTS LIST

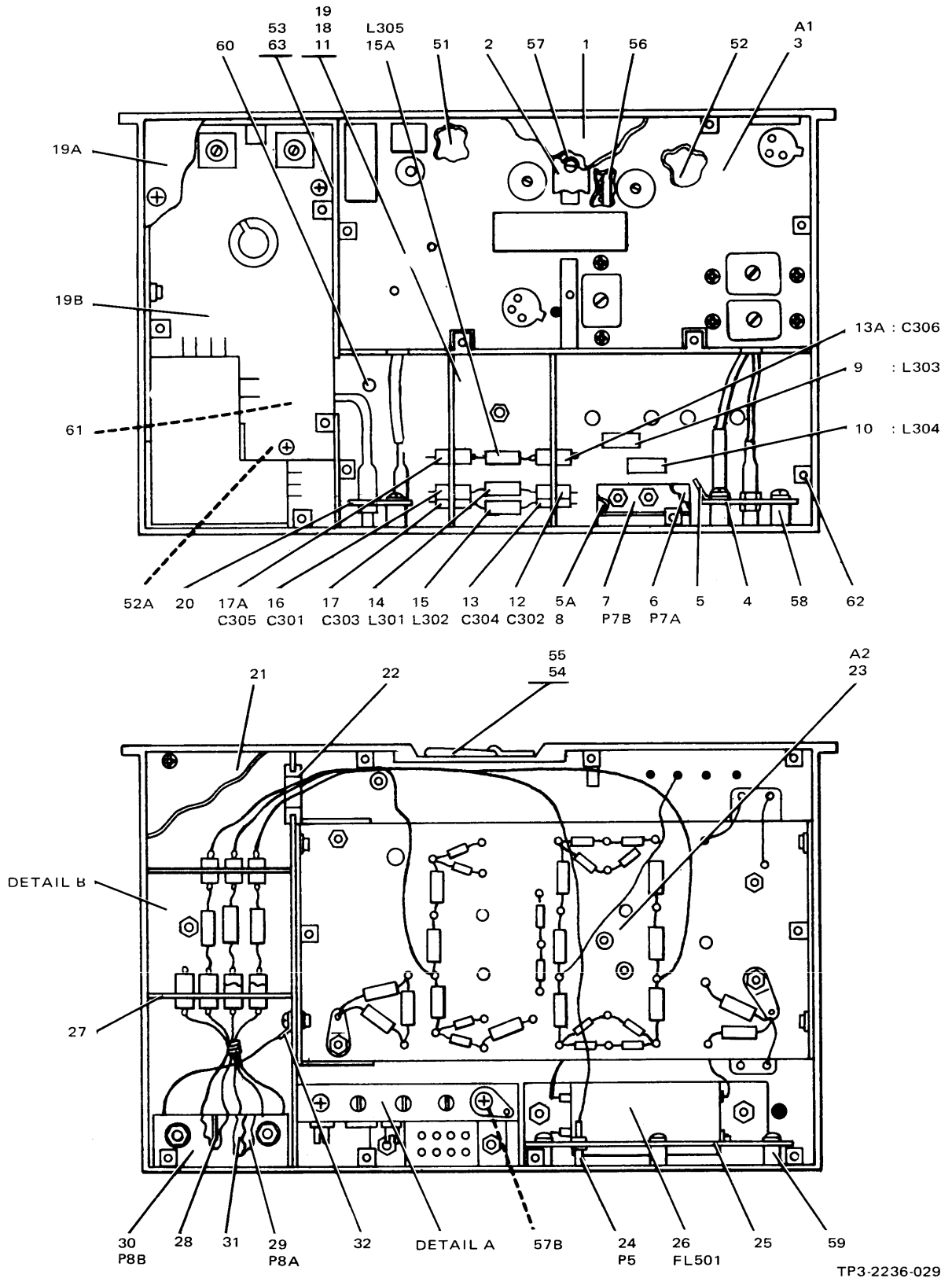

RF Module Assembly (A6) 790-1048-020, -021  
Figure 36 (Sheet 1 of 2)

GROUP ASSEMBLY PARTS LIST

DETAIL A

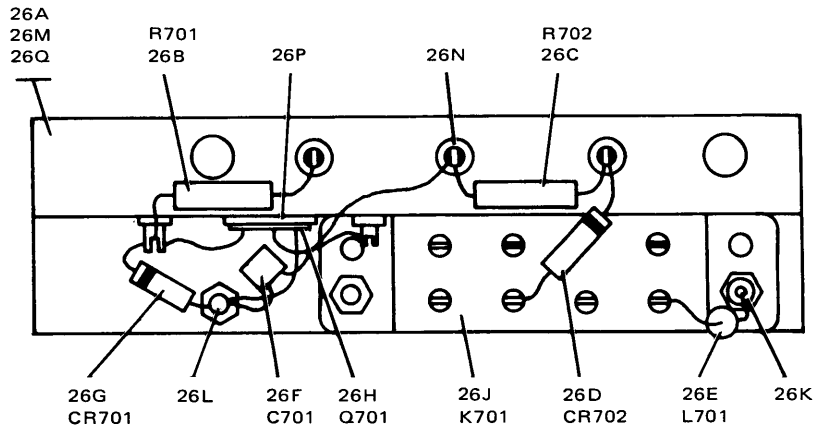

DETAIL B

USAGE CODE BY

USAGE CODE BX

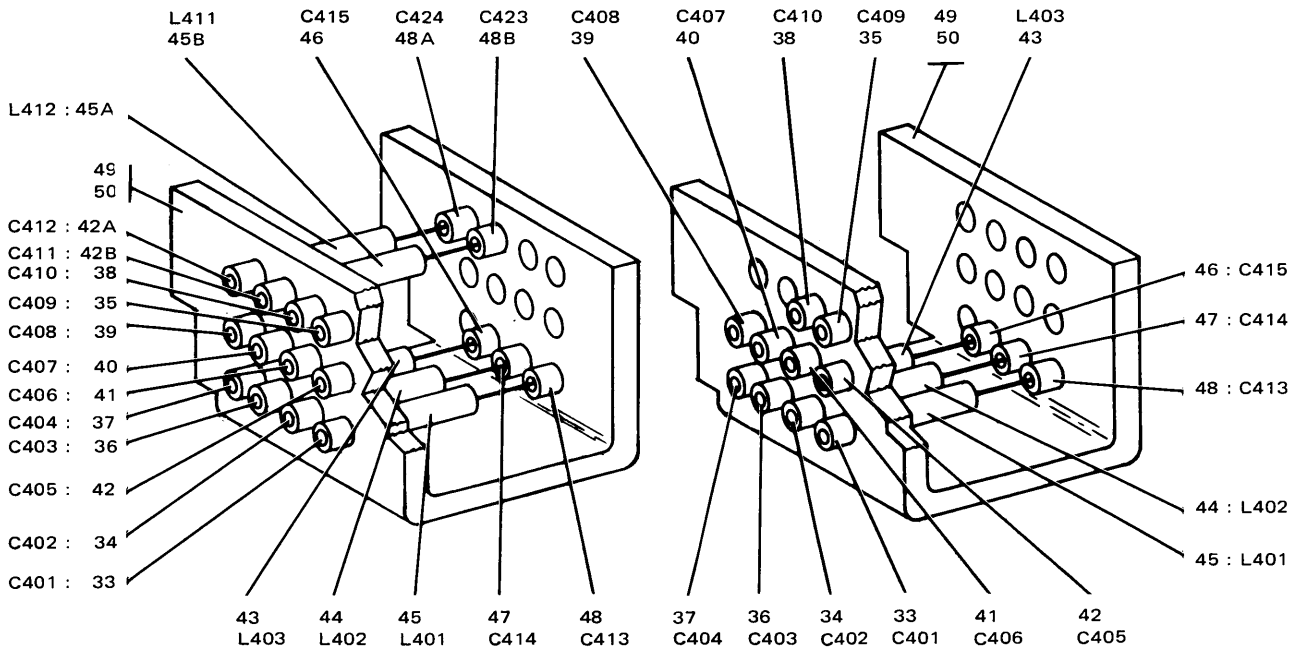

TP3-2236-029

## GROUP ASSEMBLY PARTS LIST

FIG - ITEM	PART NO	INDENT	DESCRIPTION	USABLE ON CODE	UNITS PER ASSY
36 -	790-1048-020	1	MODULE ASSEMBLY, RF A6 (SEE FIG 1-18 FOR NHA)	BX	RF
-	790-1048-021	1	MODULE ASSEMBLY, RF A6 (SEE FIG 1-18 FOR NHA)	BY	RF
1	609-1633-001	2	COVER, MIXER		1
2	790-2059-001	2	PLATE, SPACER		1
	P342-0143-000	2	SCREW, MACH, NP BRS, 2-56 X 1/4 (V77250)		2
			342-0143-000 (AP FOR 1,2)		
	P330-2284-000	2	SCREW, MACH, SST, 2-56 X 3/16 (V77250)		9
			330-2284-000 (AP FOR 1,2)		
3	618-3258-001	2	MIXER, RADIO FREQUENCY A6A1 (SEE FIG 37)		1
	MS51959-2	2	SCREW, MACH, SST, 2-56 X 3/16 (V96906)		2
			342-0132-000 (AP)		
	P343-0298-000	2	SCREW, MACH, NP BRS, 2-56 X 3/16 (V77250)	BX	3
			343-0298-000 (AP)		
	P343-0298-000	2	SCREW, MACH, NP BRS, 2-56 X 3/16 (V77250)	BY	4
			343-0298-000 (AP)		
	P343-0297-000	2	SCREW, MACH, NP BRS, 2-56 X 1/8 (V77250)	BX	1
			343-0297-000 (AP)		
	P347-0103-000	2	SCREW, MACH, NP BRS, 2-56 X 3/16 (V77250)		2
			347-0103-000 (AP)		
	MS35338-96	2	WASHER, LOCK, BRZ, 0.088 ID X 0.175 OD (V96906)		2
			310-0074-000 (AP)		
	310-6320-000	2	WASHER, FLAT, SST, 0.092 ID X 0.218 OD (V79807)		2
			310-6320-000 (AP)		
4	790-1358-001	2	PLATE, CONNECTOR MTG		1
5	4007-4HT	2	TERMINAL, LUG, (V77147) 304-0015-000		1
	MS51957-13	2	SCREW, MACH, STL, 4-40 X 1/4 (V96906)		3
			343-0133-000 (AP FOR 4,5)		
	MS35338-135	2	WASHER, LOCK, SST, 0.115 ID X 0.209 OD (V96906)		3
			310-0279-000 (AP FOR 4,5)		
5A	372-2255-020	2	CONTACT, ELEC, 372-2255-020		3
6	790-1378-001	2	CONNECTOR, A6P7A		1
7	790-1378-002	2	CONNECTOR, A6P7B		1
8	790-1367-001	2	SHIM, CONNECTOR		2
	68-1660-26	2	NUT, SLFLKG, HEX, AL, 2-56 (V72962) 333-0604-000		2
			(AP FOR 6-8)		
	310-6320-000	2	WASHER, FLAT, SST, 0.092 ID X 0.218 OD (V79807)		2
			310-6320-000 (AP FOR 6-8)		
	MS51957-10	2	SCREW, MACH, SST, 2-56 X 7/8 (V96906)		2
			343-0130-000 (AP FOR 6-8)		
9	MS90537-41	2	COIL, RF, 220UH (V96906) 240-2715-410 A6L303	BX	1
			(EFF TO CI 72496)		
9	MS90537-37	2	COIL, RF, 100UH (V96906) 240-2715-370 A6L303	BX	1
			(EFF CI 72496)		
9	MS90537-37	2	COIL, RF, 100UH (V96906) 240-2715-370 A6L303	BY	1
10	MS90537-41	2	COIL, RF, 220UH (V96906) 240-2715-410 A6L304	BX	1
			(EFF TO CI 72496)		
10	MS90537-37	2	COIL, RF, 100UH (V96906) 240-2715-370 A6L304	BX	1
			(EFF CI 72496)		
10	MS90537-37	2	COIL, RF, 100UH (V96906) 240-2715-370 A6L304	BY	1
11	606-9879-002	2	FILTER NETWORK, (EFF TO CI 72443)	BX	1
11	606-9879-004	2	FILTER NETWORK (EFF CI 72443)	BX	1
11	606-9879-005	2	FILTER NETWORK	BY	1
	68-1660-26	2	NUT, SLFLKG, HEX, AL, 2-56 (V72962) 333-0604-000		2
			(AP)		
	310-6320-000	2	WASHER, FLAT, SST, 0.092 ID X 0.218 OD (V79807)		2
			310-6320-000 (AP)		
	MS51959-3	2	SCREW, MACH, SST, 2-56 X 1/4 (V96906)		2
			342-0133-000 (AP)		
12	2465-009W5T0102P	3	CAPACITOR, FXD, CER DIEL, 1000PF, GMV, 500V		1
			(V72962) 913-3209-000 A6C302		
13	2465-009W5T0102P	3	CAPACITOR, FXD, CER DIEL, 1000PF, GMV, 500V		1
			(V72962) 913-3209-000 A6C304		

GROUP ASSEMBLY PARTS LIST

FIG - ITEM	PART NO	INDENT	DESCRIPTION	USABLE ON CODE	UNITS PER ASSY
36	13A 2465-009W5T0102P	3	CAPACITOR,FXD, CER DIEL, 1000PF, GMV, 500V (V72982) 913-3209-000 A6C306	BY	1
	14 MS90538-06	3	COIL,RF, 56UH (V96906) 240-2510-000 A6L301		1
	15 MS90538-06	3	COIL,RF, 56UH (V96906) 240-2510-000 A6L302		1
	15A MS90538-06	3	COIL,RF, 56UH (V96906) 240-2510-000 A6L305	BY	1
	16 2465-009W5T0102P	3	CAPACITOR,FXD, CER DIEL, 1000PF, GMV, 500V (V72982) 913-3209-000 A6C301		1
	17 2465-009W5T0102P	3	CAPACITOR,FXD, CER DIEL, 1000PF, GMV, 500V (V72982) 913-3209-000 A6C303		1
	17A 2465-009W5T0102P	3	CAPACITOR,FXD, CER DIEL, 1000PF, GMV, 500V (V72982) 913-3209-000 A6C305	BY	1
	18 054-0368-010	3	RING,SOLDER		4
	19 609-1360-001	3	BRACKET, FILTER		1
	19A 609-1632-001	2	COVER,VLF		1
	P330-2284-000	2	SCREW,MACH, SST, 2-56 X 3/16 (V77250) 330-2284-000 (AP)		6
	19B 609-1643-001	2	MIXER,VLF, (SEE FIG 18)	BY	1
	MS51959-2	2	SCREW,MACH, SST, 2-56 X 3/16 (V96906) 342-0132-000 (AP)	BY	2
	P343-0298-000	2	SCREW,MACH, NP BRS, 2-56 X 3/16 (V77250) 343-0298-000 (AP)	BY	2
	MS35338-96	2	WASHER,LOCK, BRZ, 0.088 ID X 0.175 OD (V96906) 310-0074-000 (AP)	BY	2
	20 790-1357-001	2	PLATE, CONNECTOR MTG		1
	MS51957-13	2	SCREW,MACH, STL, 4-40 X 1/4 (V96906) 343-0133-000 (AP)		2
	MS35338-135	2	WASHER,LOCK, SST, 0.115 ID X 0.209 OD (V96906) 310-0279-000 (AP)		2
	21 609-1635-001	2	COVER,FILTER		1
	P330-2284-000	2	SCREW,MACH, SST, 2-56 X 3/16 (V77250) 330-2284-000 (AP)		10
	22 DIE30071	2	RUBBER CHANNEL, (V75183) 200-5310-000		AR
	23 618-7678-001	2	SWITCH ASSY, FILTER/DIODE A6A2 (SEE FIG 38)	BY	1
	23 618-7678-002	2	SWITCH ASSY, FILTER/DIODE A6A2 (SEE FIG 38)	BY	1
	P330-2290-000	2	SCREW,MACH, SST, 4-40 X 1/4 (V77250) 330-2290-000 (AP)		2
	MS51957-13	2	SCREW,MACH, STL, 4-40 X 1/4 (V96906) 343-0133-000 (AP)		1
	MS51957-14	2	SCREW,MACH, STL, 4-40 X 5/16 (V96906) 343-0134-000 (AP)		1
	MS35338-135	2	WASHER,LOCK, SST, 0.115 ID X 0.209 OD (V96906) 310-0279-000 (AP)		1
	24 141-1002-0002	2	CONNECTOR,RCPT, ELEC (V98278) 357-7353-010 A6P5		1
	25 790-1350-001	2	BRACKET, CONNECTOR MTG		1
	MS51957-13	2	SCREW,MACH, STL, 4-40 X 1/4 (V96906) 343-0133-000 (AP)		3
	MS35338-135	2	WASHER,LOCK, SST, 0.115 ID X 0.209 OD (V96906) 310-0279-000 (AP)		3
	26 A188	2	FILTER,LP, (V81815) 241-0609-010 A6FL501		1
	MS35649-244	2	NUT,PLAIN,HEX, SST, 4-40 (V96906) 313-0043-000 (AP)		2
	MS35338-135	2	WASHER,LOCK, SST, 0.115 ID X 0.209 OD (V96906) 310-0279-000 (AP)		2
	P330-2290-000	2	SCREW,MACH, SST, 4-40 X 1/4 (V77250) 330-2290-000 (AP)		2
	26A 609-1644-001	2	SWITCH ASSY, ANTENNA	BY	1
	MS51957-2	2	SCREW,MACH, SST, 2-56 X 3/16 (V96906) 343-0123-000 (AP)	BY	2
	MS35338-96	2	WASHER,LOCK, BRZ, 0.088 ID X 0.175 OD (V96906) 310-0074-000 (AP)	BY	2
	4040-2HDSPL	2	TERMINAL,LUG, (V77147) 304-0331-000 (AP)	BY	1
	26B RCR07G103KS	3	RESISTOR,FXD, CMPSN, 10K, 10%, 1/4W (V81349) 745-0785-000 A6R701	BY	1

## GROUP ASSEMBLY PARTS LIST

FIG - ITEM	PART NO	INDENT	DESCRIPTION	USABLE ON CODE	UNITS PER ASSY
36	26C RCR07G100KS	3	RESISTOR,FXD, CMPSN, 10 OHMS, 10%, 1/4W (V81349) 745-0677-000 A6R702	BY	1
	26D 1N459	3	SEMICONV DEVICE, (V07688) 353-0206-000 A6R702	BY	1
	26E MS90537-25	3	COIL,RF, 10UH (V96906) 240-2715-250 A6L701	BY	1
	26F 2C067104X0101A3	3	CAPACITOR,FXD, CER DIEI, 0.1UF, 20%, 100V (V56289) 913-4240-040 A6C701	BY	1
	26G 1N459	3	SEMICONV DEVICE, (V07688) 353-0206-000 A6R701	BY	1
	26H 2N2222A	3	TRANSISTOR, (V81350) 352-7500-280 A6Q701	BY	1
	26J JSAV1556A2	3	RELAY,AMT, (V01526) 974-1065-260 A6K701	BY	1
	26K TF300	3	TERMINAL,STUD, (V98291) 306-1018-000	BY	1
	P313-0484-010	3	NUT,PLAIN,HEX, NP BRS, 2-56 (V77250) 313-0484-010 (AP FOR 26J,26K)	BY	1
	MS35338-96	3	WASHER,LOCK, BRZ, 0.088 ID X 0.175 OD (V96906) 310-0074-000 (AP FOR 26J,26K)	BY	2
	MS51957-2	3	SCREW,MACH, SST, 2-56 X 3/16 (V96906) 343-0123-000 (AP FOR 26J,26K)	BY	2
	26L AB404D	3	TERMINAL,GND, (V12615) 309-1309-000	BY	1
	P313-0484-010	3	NUT,PLAIN,HEX, NP BRS, 2-56 (V77250) 313-0484-010 (AP)	BY	1
	MS35338-96	3	WASHER,LOCK, BRZ, 0.088 ID X 0.175 OD (V96906) 310-0074-000 (AP)	BY	1
	26M 609-1642-001	3	BRACKET,RELAY, PRSD	BY	1
	26N SL481-491WHT	4	TERMINAL,STUD, (V12615) 306-2511-100	BY	5
	26P T1532	4	HOLDER,XSTR, (V98291) 352-9508-000	BY	1
	26Q 609-1566-001	4	BRACKET,RELAY	BY	1
	27 618-3260-001	2	FILTER NETWORK	BX	1
	27 618-3260-002	2	FILTER NETWORK	BY	1
	68-1660-26	2	NUT,SLFLKG,HEX, AL, 2-56 (V72962) 333-0604-000 (AP)		2
	310-6320-000	2	WASHER,FLAT, SST, 0.092 ID X 0.218 OD (V79807) 310-6320-000 (AP)		2
	MS51957-13	2	SCREW,MACH, STL, 4-40 X 1/4 (V96906) 343-0133-000 (AP)		2
	28 372-2255-020	3	CONTACT,ELEC, 372-2255-020		11
	29 790-1377-001	3	CONNECTOR, A6P8A		1
	30 790-1377-002	3	CONNECTOR, A6P8B		1
	31 790-1365-001	3	SHIM, CONNECTOR		1
	68-1660-26	3	NUT,SLFLKG,HEX, AL, 2-56 (V72962) 333-0604-000 (AP FOR 29-31)		2
	310-6320-000	3	WASHER,FLAT, SST, 0.092 ID X 0.218 OD (V79807) 310-6320-000 (AP FOR 29-31)		2
	MS51957-10	3	SCREW,MACH, SST, 2-56 X 7/8 (V96906) 343-0130-000 (AP FOR 29-31)		2
	32 4007-4HT	3	TERMINAL,LUG, (V77147) 304-0015-000		1
	33 2465-009W5T0102P	3	CAPACITOR,FXD, CER DIEI, 1000PF, GMV, 500V (V72982) 913-3209-000 A6C401		1
	34 2465-009W5T0102P	3	CAPACITOR,FXD, CER DIEI, 1000PF, GMV, 500V (V72982) 913-3209-000 A6C402		1
	35 2465-009W5T0102P	3	CAPACITOR,FXD, CER DIEI, 1000PF, GMV, 500V (V72982) 913-3209-000 A6C409		1
	36 2465-009W5T0102P	3	CAPACITOR,FXD, CER DIEI, 1000PF, GMV, 500V (V72982) 913-3209-000 A6C403		1
	37 2465-009W5T0102P	3	CAPACITOR,FXD, CER DIEI, 1000PF, GMV, 500V (V72982) 913-3209-000 A6C404		1
	38 2465-009W5T0102P	3	CAPACITOR,FXD, CER DIEI, 1000PF, GMV, 500V (V72982) 913-3209-000 A6C410		1
	39 2465-009W5T0102P	3	CAPACITOR,FXD, CER DIEI, 1000PF, GMV, 500V (V72982) 913-3209-000 A6C408		1
	40 2465-009W5T0102P	3	CAPACITOR,FXD, CER DIEI, 1000PF, GMV, 500V (V72982) 913-3209-000 A6C407		1
	41 2465-009W5T0102P	3	CAPACITOR,FXD, CER DIEI, 1000PF, GMV, 500V (V72982) 913-3209-000 A6C406		1

GROUP ASSEMBLY PARTS LIST

FIG - ITEM	PART NO	INDENT	DESCRIPTION	USABLE ON CODE	UNITS PER ASSY
36	42	2465-009W5T0102P	3 CAPACITOR,FXD, CER DIEI, 1000PF, GMV, 500V (V72982) 913-3209-000 A6C405		1
	42A	2465-009W5T0102P	3 CAPACITOR,FXD, CER DIEI, 1000PF, GMV, 500V (V72982) 913-3209-000 A6C412	BY	1
	42B	2465-009W5T0102P	3 CAPACITOR,FXD, CER DIEI, 1000PF, GMV, 500V (V72982) 913-3209-000 A6C411	BY	1
	43	MS90538-06	3 COIL,RF, 56UH (V96906) 240-2510-000 A6L403		1
	44	MS90538-06	3 COIL,RF, 56UH (V96906) 240-2510-000 A6L402		1
	45	MS90537-49	3 COIL,RF, 1000UH (V96906) 240-2715-490 A6L401		1
	45A	MS90538-06	3 COIL,RF, 56UH (V96906) 240-2510-000 A6L412	BY	1
	45B	MS90538-06	3 COIL,RF, 56UH (V96906) 240-2510-000 A6L411	BY	1
	46	2465-009W5T0102P	3 CAPACITOR,FXD, CER DIEI, 1000PF, GMV, 500V (V72982) 913-3209-000 A6C415		1
	47	2465-009W5T0102P	3 CAPACITOR,FXD, CER DIEI, 1000PF, GMV, 500V (V72982) 913-3209-000 A6C414		1
	48	2465-009W5T0102P	3 CAPACITOR,FXD, CER DIEI, 1000PF, GMV, 500V (V72982) 913-3209-000 A6C413		1
	48A	2465-009W5T0102P	3 CAPACITOR,FXD, CER DIEI, 1000PF, GMV, 500V (V72982) 913-3209-000 A6C424	BY	1
	48B	2465-009W5T0102P	3 CAPACITOR,FXD, CER DIEI, 1000PF, GMV, 500V (V72982) 913-3209-000 A6C423	BY	1
	49	054-0368-010	3 RING,SOLDER		13
	50	609-1561-001	3 BRACKET, FILTER		1
	51	790-1402-001	2 SHEET, INSUL		1
	52	790-1401-001	2 SHEET, INSUL		1
	52A	609-1570-002	2 POST	BY	2
	52B	609-1570-001	2 POST	BY	2
		MS51959-3	2 SCREW,MACH, SST, 2-56 X 1/4 (V96906) 342-0133-000 (AP FOR 52A,52B)	BY	4
	53	609-1631-001	2 CHASSIS, PRSD		1
	54	548-6127-002	3 HANDLE, BAIL		1
	55	546-6126-002	3 RETAINER, HANDLE		1
		R4008X1-8CHROMAT	3 RIVET,TUBULAR, AL, 0.089 DIA X 1/8 (V12014)		2
		EDP	305-0170-000 (AP)		
	56	790-1472-001	3 STRIP, CONTACT, GROUNDING		1
		SE23CDPL	3 EYELET,MTLC, CD PL BRS, 0.062 DIA X 0.092 (V90030) 307-1052-000 (AP)		5
	57	609-1544-001	3 POST		2
	58	609-1545-002	3 POST		5
	59	609-1545-001	3 POST		3
	60	SL441-434WHT	3 TERMINAL,STUD, (V12615) 306-2222-100		2
	61	SL354-351WHT	3 TERMINAL,FEEDTH, (V12615) 306-2474-010		2
	62	609-1638-001	3 FASTENER, ANGLE		21
	63	609-1546-001	3 CHASSIS		1
37 -	618-3258-001	1	MIXER, RADIO FREQUENCY A6A1 (SEE FIG 36-3 FOR NHA)	BX,BY	RF
	1	RCR05G101JS	2 RESISTOR,FXD, CMPSN, 100 OHMS, 5%, 1/8W (V81349) 745-1863-250 A6A1R5		1
	2	1N5767	2 SEMICOND DEVICE, (V07688) 922-6119-010 A6A1CR4		1
	3	1N5767	2 SEMICOND DEVICE, (V07688) 922-6119-010 A6A1CR3		1
	4	A260	2 TRANSFORMER,RF, (V81815) 278-0375-010 A6A1T1		1
	5	DM5C120D050WV	2 CAPACITOR,FXD, MICA DIEI, 12PF, 0.5PF, 50V (V72136) 912-4141-120 A6A1C50		1
	6	DM5C120D050WV	2 CAPACITOR,FXD, MICA DIEI, 12PF, 0.5PF, 50V (V72136) 912-4141-120 A6A1C49		1



GROUP ASSEMBLY PARTS LIST

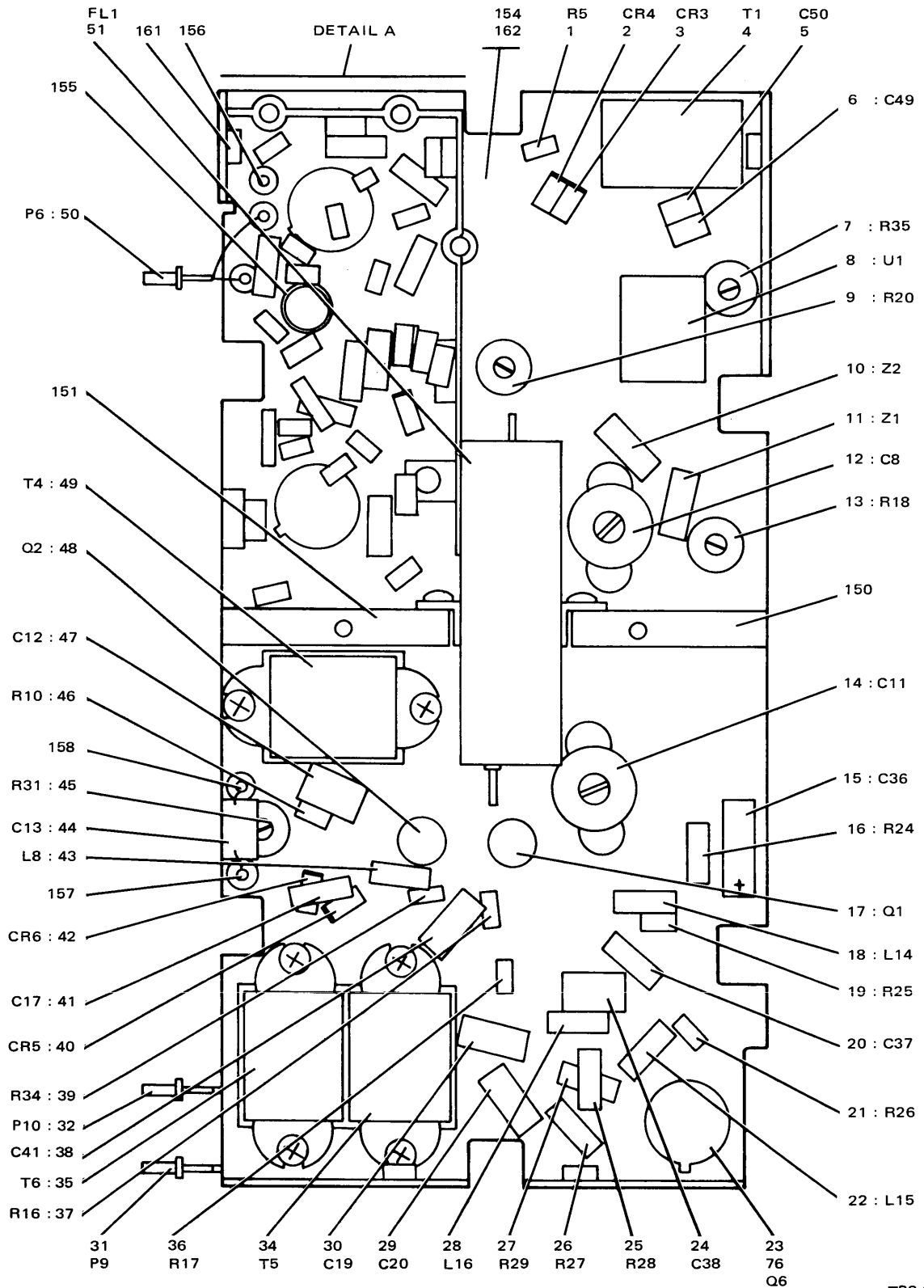

TP3-2235-039

Radio Frequency Mixer (A6A1) 618-3258-001  
Figure 37 (Sheet 1 of 3)

GROUP ASSEMBLY PARTS LIST

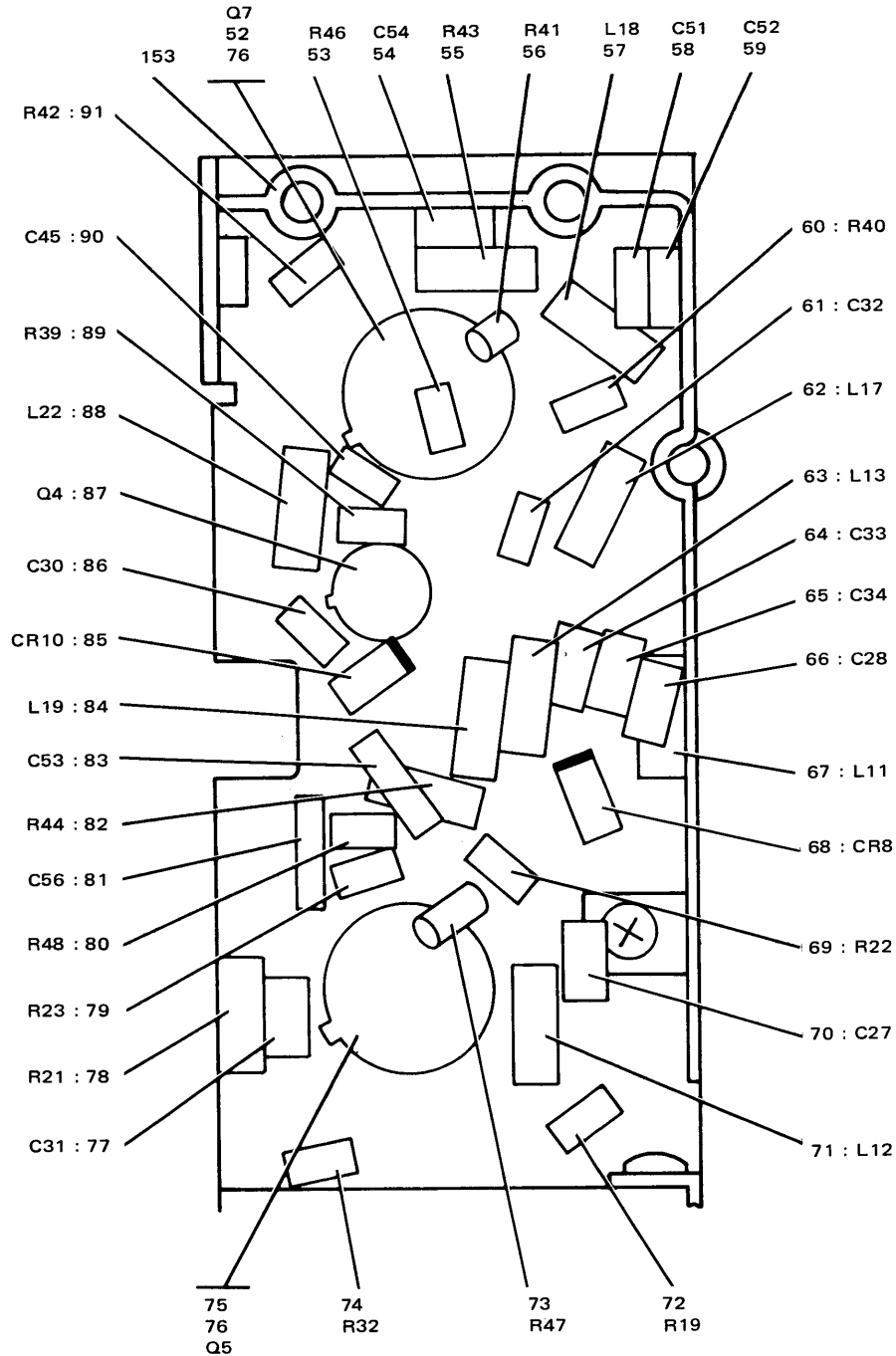

DETAIL A

TP3-2235-039

Radio Frequency Mixer (A6A1) 618-3258-001  
Figure 37 (Sheet 2 of 3)

GROUP ASSEMBLY PARTS LIST

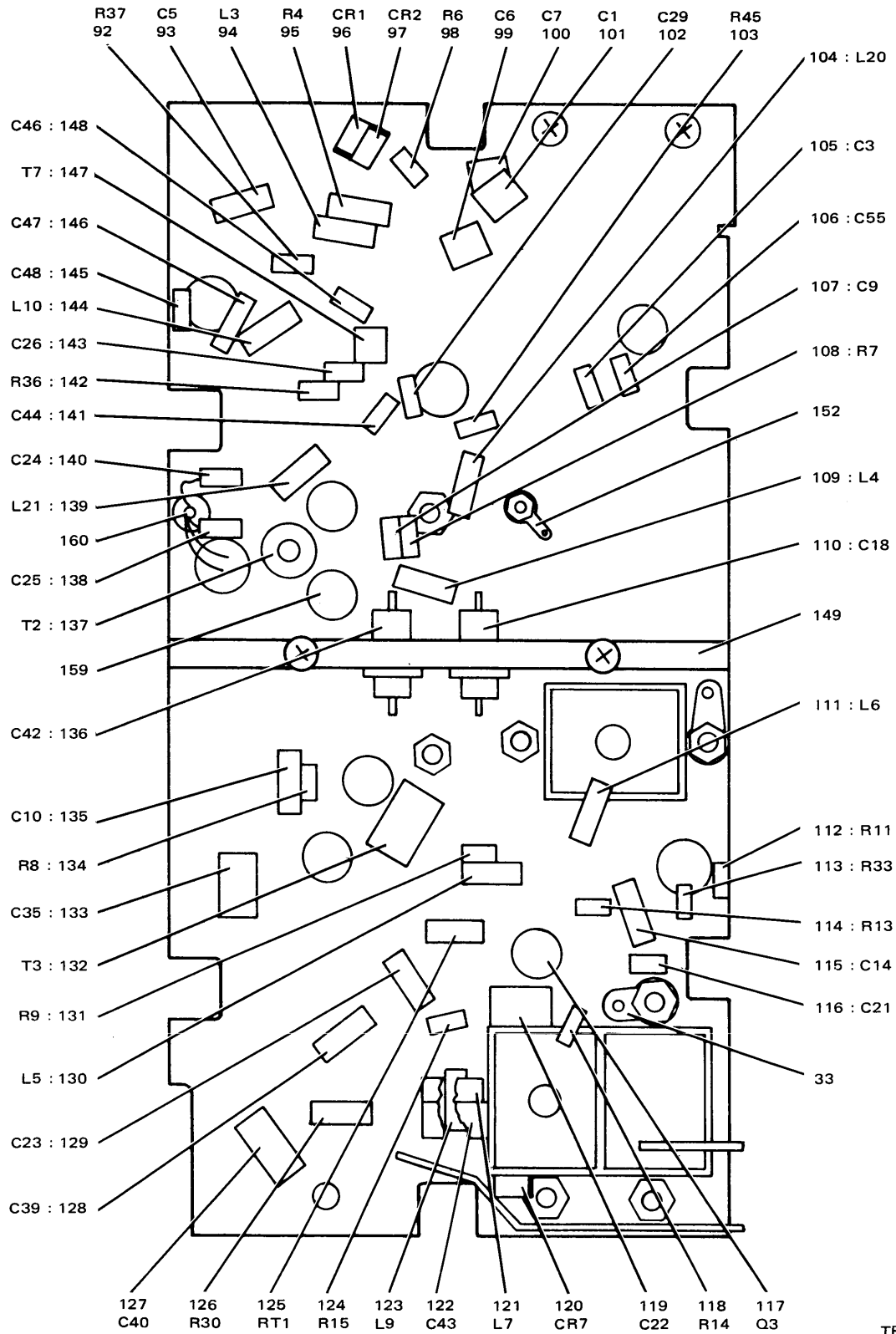

TP3-2235-039

Radio Frequency Mixer (A6A1) 618-3258-001  
 Figure 37 (Sheet 3 of 3)

GROUP ASSEMBLY PARTS LIST

FIG - ITEM	PART NO	INDENT	DESCRIPTION	USABLE ON CODE	UNITS PER ASSY
37	7	61PNR500	2 RESISTOR,VAR, 500 OHMS, 20%, 1/2W (V7313A) JA1-1740-060 A6A1R35		1
	8	350-3080-020	2 MICROCIRCUIT, 350-3080-020 A6A1U1		1
	9	3329H1-502	2 RESISTOR,VAR, 5K, 20%, 0.5W (V80294) 382-0027-090 A6A1R20		1
	10	790-0266-001	2 SUPPRESSOR, PARASITIC A6A1Z2		1
	11	790-0266-001	2 SUPPRESSOR, PARASITIC A6A1Z1		1
	12	538002COP089R	2 CAPACITOR,VAR, CER DIEL, 2 TO 8PF, 350V (V729A2) 917-1228-000 A6A1C8		1
	13	61PNR500	2 RESISTOR,VAR, 500 OHMS, 20%, 1/2W (V7313A) 381-1740-060 A6A1R18		1
	14	538002COP089R	2 CAPACITOR,VAR, CER DIEL, 2 TO 8PF, 350V (V729A2) 917-1228-000 A6A1C11		1
	15	M39003-01-2029	2 CAPACITOR,FXD, ELCTLT, 3.3UF, 20%, 15V (V81349) 184-9083-290 A6A1C36		1
	16	T055-1K1F	2 RESISTOR,FXD, FILM, 1K, 1%, 1/8W (V11502) 705-1454-390 A6A1R24		1
	17	FN2173	2 TRANSISTOR, (V17496) 352-0756-010 A6A1Q1		1
	18	240-2711-170	2 COIL,RF, 2.20UH (V99800) 240-2711-170 A6A1L14		1
	19	RCR05G181JS	2 RESISTOR,FXD, CMPSN, 180 OHMS, 5%, 1/8W (V81349) 745-1863-310 A6A1R25		AR
	19	RCR05G221JS	2 RESISTOR,FXD, CMPSN, 220 OHMS, 5%, 1/8W (V81349) 745-1863-330 A6A1R25		AR
	19	RCR05G271JS	2 RESISTOR,FXD, CMPSN, 270 OHMS, 5%, 1/8W (V81349) 745-1863-350 A6A1R25		AR
	19	RCR05G331JS	2 RESISTOR,FXD, CMPSN, 330 OHMS, 5%, 1/8W (V81349) 745-1863-370 A6A1R25		AR
	19	RCR05G391JS	2 RESISTOR,FXD, CMPSN, 390 OHMS, 5%, 1/8W (V81349) 745-1863-390 A6A1R25		AR
	19	RCR05G561JS	2 RESISTOR,FXD, CMPSN, 560 OHMS, 5%, 1/8W (V81349) 745-1863-430 A6A1R25		AR
	19	RCR05G102JS	2 RESISTOR,FXD, CMPSN, 1K, 5%, 1/8W (V81349) 745-1863-490 A6A1R25		AR
	20	2C067102X0101A3	2 CAPACITOR,FXD, CER DIEL, 0.001UF, 20%, 100V (V56289) 913-4240-140 A6A1C37		1
	21	RCR05G680JS	2 RESISTOR,FXD, CMPSN, 68 OHMS, 5%, 1/8W (V81349) 745-1863-210 A6A1R26		1
	22	MS75083-09	2 COIL,RF, 0.47UH (V96906) 240-2019-000 A6A1L15		1
	23	2N5109	2 TRANSISTOR, (V07688) 352-0766-010 A6A1Q6		1
	24	DM5F151J050WV	2 CAPACITOR,FXD, MICA DIEL, 150PF, 5%, 50V (V72136) 912-4141-400 A6A1C38		1
	25	T055-2-87K1F	2 RESISTOR,FXD, FILM, 2.87K, 1%, 1/8W (V11502) 705-1454-500 A6A1R28		1
	26	T055-27R4-1F	2 RESISTOR,FXD, FILM, 27.4 OHMS, 1%, 1/8W (V11502) 705-1470-220 A6A1R27		1
	27	T055-3010-1F	2 RESISTOR,FXD, FILM, 301 OHMS, 1%, 1/8W (V11502) 705-1470-490 A6A1R29		1
	28	240-2711-300	2 COIL,RF, 27UH (V99800) 240-2711-300 A6A1L16		1
	29	8131-050-651-104 M	2 CAPACITOR,FXD, CER DIEL, 0.1UF, 20%, 50V (V72982) 913-3279-200 A6A1C20		1
	30	8131-050-651-104 M	2 CAPACITOR,FXD, CER DIEL, 0.1UF, 20%, 50V (V72982) 913-3279-200 A6A1C19		1
	31	140-0530-9014	2 CABLE ASSY,ELEC, (V98278) 426-5435-270 A6A1P9		1
	32	140-0530-9014	2 CABLE ASSY,ELEC, (V98278) 426-5435-270 A6A1P10		1
	33	4040-2HT	2 TERMINAL,LUG, (V77147) 304-0014-000		1
	34	278-0349-020	2 TRANSFORMER,RF, (V81815) 278-0349-020 A6A1T5		1
		MS35649-224	2 NUT,PLAIN,HEX, SST, 2-56 (V96906) 313-0037-000 (AP FOR 33,34)		3
		MS35333-69	2 WASHER,LOCK, SST, 0.095 ID X 0.185 OD (V96906) 373-4500-000 (AP FOR 33,34)		3
		310-0129-000	2 WASHER,FLAT, BRS, 0.089 ID X 0.188 OD (V05411) 310-0129-000 (AP FOR 33,34)		2

## GROUP ASSEMBLY PARTS LIST

FIG - ITEM	PART NO	INDENT	DESCRIPTION	USABLE ON CODE	UNITS PER ASSY
37	MS51957-3	2	SCREW, MACH, CD PL STL, 2-56 X 1/4 (V96906) 343-0124-000 (AP FDR 33,34)		3
35	278-0401-020	2	TRAP CIRCUIT A6A1T6 (EFF TO CI 72496)		1
	MS35649-224	2	NUT, PLAIN, HEX, SST, 2-56 (V96906) 313-0037-000 (AP) (EFF TO CI 72496)		1
	310-0070-000	2	WASHER, LOCK, SST, 0.097 ID X 0.165 OD (V79807) 310-0070-000 (AP) (EFF TO CI 72496)		1
	MS51957-3	2	SCREW, MACH, CD PL STL, 2-56 X 1/4 (V96906) 343-0124-000 (AP) (EFF TO CI 72496)		1
36	RCR05G221JS	2	RESISTOR, FXD, CMPSN, 220 OHMS, 5%, 1/8W (V81349) 745-1863-330 A6A1R17		1
37	RCR05G331JS	2	RESISTOR, FXD, CMPSN, 330 OHMS, 5%, 1/8W (V81349) 745-1863-370 A6A1R16		1
38	8131-050-651-104 M	2	CAPACITOR, FXD, CER DIEL, 0.1UF, 20%, 50V (V72982) 913-3279-200 A6A1C41		1
39	RCR05G102JS	2	RESISTOR, FXD, CMPSN, 1K, 5%, 1/8W (V81349) 745-1863-490 A6A1R34		1
40	1N5767	2	SEMICONV DEVICE, (V07688) 922-6119-010 A6A1CR5		1
41	2C067103X0101A3	2	CAPACITOR, FXD, CER DIEL, 0.01UF, 20%, 100V (V56289) 913-4240-100 A6A1C17		1
42	1N5767	2	SEMICONV DEVICE, (V07688) 922-6119-010 A6A1CR6		1
43	MS75085-07	2	COIL, RF, 100UH (V96906) 240-2047-000 A6A1L8		1
44	DM5F101J050WV	2	CAPACITOR, FXD, MICA DIEL, 100PF, 5%, 50V (V72136) 912-4141-050 A6A1C13		1
45	J329H1-502	2	RESISTOR, VAR, 5K, 20%, 0.5W (V80294) 382-0027-090 A6A1R31		1
46	RCR05G100JS	2	RESISTOR, FXD, CMPSN, 10 OHMS, 5%, 1/8W (V81349) 745-1863-010 A6A1R10		1
47	DM5F101J050WV	2	CAPACITOR, FXD, MICA DIEL, 100PF, 5%, 50V (V72136) 912-4141-050 A6A1C12		1
48	FN2173	2	TRANSISTOR, (V17896) 352-0756-070 A6A1Q2		1
49	A284	2	TRANSFORMER, RF, (V81815) 278-0393-010 A6A1T4		1
	MS35649-224	2	NUT, PLAIN, HEX, SST, 2-56 (V96906) 313-0037-000 (AP)		2
	MS35333-69	2	WASHER, LOCK, SST, 0.095 ID X 0.185 OD (V96906) 373-8500-000 (AP)		2
	310-0129-000	2	WASHER, FLAT, BRS, 0.089 ID X 0.188 OD (V05411) 310-0129-000 (AP)		2
	4040-2HT	2	TERMINAL, LUG, (V77147) 304-0014-000 (AP)		1
	MS51957-3	2	SCREW, MACH, CD PL STL, 2-56 X 1/4 (V96906) 343-0124-000 (AP)		2
50	140-0530-9014	2	CABLE ASSY, ELEC, (V98278) 426-5435-270 A6A1P6		1
51	2Q1	2	FILTER, BANDPASS, (V00136) 293-1222-010 A6A1FL1		1
	MS35649-224	2	NUT, PLAIN, HEX, SST, 2-56 (V96906) 313-0037-000 (AP)		2
	MS35333-69	2	WASHER, LOCK, SST, 0.095 ID X 0.185 OD (V96906) 373-8500-000 (AP)		4
	MS51957-3	2	SCREW, MACH, CD PL STL, 2-56 X 1/4 (V96906) 343-0124-000 (AP)		2
52	2N5109	2	TRANSISTOR, (V07688) 352-0766-010 A6A1Q7		1
53	RCR05G100JS	2	RESISTOR, FXD, CMPSN, 10 OHMS, 5%, 1/8W (V81349) 745-1863-010 A6A1R46		1
54	DM5F301J050WV	2	CAPACITOR, FXD, MICA DIEL, 300PF, 5%, 50V (V72136) 912-4141-480 A6A1C54		1
55	RCR07G220KS	2	RESISTOR, FXD, CMPSN, 22 OHMS, 10%, 1/4W (V81349) 745-0689-000 A6A1R43		1
56	RCR05G100JS	2	RESISTOR, FXD, CMPSN, 10 OHMS, 5%, 1/8W (V81349) 745-1863-010 A6A1R41		1
57	MS75083-09	2	COIL, RF, 0.47UH (V96906) 240-2019-000 A6A1L18		1
58	2C067103X0101A3	2	CAPACITOR, FXD, CER DIEL, 0.01UF, 20%, 100V (V56289) 913-4240-100 A6A1C51		1
59	DM5F151J050WV	2	CAPACITOR, FXD, MICA DIEL, 150PF, 5%, 50V (V72136) 912-4141-400 A6A1C52		1

## GROUP ASSEMBLY PARTS LIST

FIG - ITEM	PART NO	INDENT	DESCRIPTION	USABLE ON CODE	UNITS PER ASSY
37	60	RCR05G152JS	2 RESISTOR,FXD, CMPSN, 1.5K, 5%, 1/8W (V81349) 745-1863-530 A6A1R40		1
	61	DM5F301J050WV	2 CAPACITOR,FXD, MICA DIEI, 300PF, 5%, 50V (V72136) 912-4141-480 A6A1C32		1
	62	240-2711-300	2 COIL,RF, 27UH (V99800) 240-2711-300 A6A1L17		1
	63	240-2711-300	2 COIL,RF, 27UH (V99800) 240-2711-300 A6A1L13		1
	64	2C067103X0101A3	2 CAPACITOR,FXD, CER DIEI, 0.01UF, 20%, 100V (V56289) 913-4240-100 A6A1C33		1
	65	DM5F151J050WV	2 CAPACITOR,FXD, MICA DIEI, 150PF, 5%, 50V (V72136) 912-4141-400 A6A1C34		1
	66	2C067102X0101A3	2 CAPACITOR,FXD, CER DIEI, 0.001UF, 20%, 100V (V56289) 913-4240-140 A6A1C28		1
	67	MS75084-12	2 COIL,RF, 10UH (V96906) 240-2035-000 A6A1L11		1
	68	5082-8907	2 SEMICOND DEVICE, (V28480) 353-3691-010 A6A1CR8		1
	69	RCR05G152JS	2 RESISTOR,FXD, CMPSN, 1.5K, 5%, 1/8W (V81349) 745-1863-530 A6A1R22		1
	70	DM5F301J050WV	2 CAPACITOR,FXD, MICA DIEI, 300PF, 5%, 50V (V72136) 912-4141-480 A6A1C27		1
	71	MS75083-09	2 COIL,RF, 0.47UH (V96906) 240-2019-000 A6A1L12		1
	72	RCR05G100JS	2 RESISTOR,FXD, CMPSN, 10 OHMS, 5%, 1/8W (V81349) 745-1863-010 A6A1R19		1
	73	RCR05G100JS	2 RESISTOR,FXD, CMPSN, 10 OHMS, 5%, 1/8W (V81349) 745-1863-010 A6A1R47		1
	74	RCR05G4R7KS	2 RESISTOR, FXD, CMPSN, 4.7 OHMS, 10%, 1/8W (V81349) 745-0907-340 A6A1R32		1
	75	2N5109	2 TRANSISTOR, (V07688) 352-0766-010 A6A1Q5		1
	76	4005	2 INSULATOR,DISK, (V13103) 352-9582-030		3
	77	DM5F301J050WV	2 CAPACITOR,FXD, MICA DIEI, 300PF, 5%, 50V (V72136) 912-4141-480 A6A1C31		1
	78	RCR07G180KS	2 RESISTOR,FXD, CMPSN, 18 OHMS, 10%, 1/4W (V81349) 745-0686-000 A6A1R21		1
	79	RCR05G331JS	2 RESISTOR,FXD, CMPSN, 330 OHMS, 5%, 1/8W (V81349) 745-1863-370 A6A1R23		1
	80	RCR05G680JS	2 RESISTOR,FXD, CMPSN, 68 OHMS, 5%, 1/8W (V81349) 745-1863-210 A6A1R48		1
	81	8131-050-651-104 M	2 CAPACITOR,FXD, CER DIEI, 0.1UF, 20%, 50V (V72982) 913-3279-200 A6A1C56		1
	82	RCR07G101KS	2 RESISTOR,FXD, CMPSN, 100 OHMS, 10%, 1/4W (V81349) 745-0713-000 A6A1R44		1
	83	2C067102X0101A3	2 CAPACITOR,FXD, CER DIEI, 0.001UF, 20%, 100V (V56289) 913-4240-140 A6A1C53		1
	84	MS75084-12	2 COIL,RF, 10UH (V96906) 240-2035-000 A6A1L19		1
	85	1N5767	2 SEMICOND DEVICE, (V07688) 922-6119-010 A6A1CR10		1
	86	2C067102X0101A3	2 CAPACITOR,FXD, CER DIEI, 0.001UF, 20%, 100V (V56289) 913-4240-140 A6A1C30		1
	87	2N2222A	2 TRANSISTOR, (V07688) 352-0661-020 A6A1Q4		1
	88	MS75083-03	2 COIL,RF, 0.15UH (V96906) 240-2013-000 A6A1L22		1
	89	RCR05G331JS	2 RESISTOR,FXD, CMPSN, 330 OHMS, 5%, 1/8W (V81349) 745-1863-370 A6A1R39		1
	90	DM5F301J050WV	2 CAPACITOR,FXD, MICA DIEI, 300PF, 5%, 50V (V72136) 912-4141-480 A6A1C45		1
	91	RCR05G4R7KS	2 RESISTOR, FXD, CMPSN, 4.7 OHMS, 10%, 1/8W (V81349) 745-0907-340 A6A1R42		1
	92	RCR05G101JS	2 RESISTOR,FXD, CMPSN, 100 OHMS, 5%, 1/8W (V81349) 745-1863-250 A6A1R37		1
	93	2C067103X0101A3	2 CAPACITOR,FXD, CER DIEI, 0.01UF, 20%, 100V (V56289) 913-4240-100 A6A1C5		1
	94	240-2711-300	2 COIL,RF, 27UH (V99800) 240-2711-300 A6A1L3		1
	95	RCR07G680KS	2 RESISTOR,FXD, CMPSN, 68 OHMS, 10%, 1/4W (V81349) 745-0707-000 A6A1R4		1
	96	1N3070	2 SEMICOND DEVICE, (V07688) 353-3083-000 A6A1CR1		1
	97	1N3070	2 SEMICOND DEVICE, (V07688) 353-3083-000 A6A1CR2		1

## GROUP ASSEMBLY PARTS LIST

FIG - ITEM	PART NO	INDENT	DESCRIPTION	USABLE ON CODE	UNITS PER ASSY
37	98	RCR05G104JS	2 RESISTOR,FXD, CMPSN, 100K, 5%, 1/8W (V81349) 745-1864-010 A6A1R6		1
	99	8131-050-651-104 M	2 CAPACITOR,FXD, CER DIEI, 0.1UF, 20%, 50V (V72982) 913-3279-200 A6A1C6		1
	100	8131-050-651-104 M	2 CAPACITOR,FXD, CER DIEI, 0.1UF, 20%, 50V (V72982) 913-3279-200 A6A1C7		1
	101	8131-050-651-104 M	2 CAPACITOR,FXD, CER DIEI, 0.1UF, 20%, 50V (V72982) 913-3279-200 A6A1C1		1
	102	D45F151J050WV	2 CAPACITOR,FXD, MICA DIEI, 150PF, 5%, 50V (V72136) 912-4141-400 A6A1C29		1
	103	RCR05G332JS	2 RESISTOR,FXD, CMPSN, 3.3K, 5%, 1/8W (V81349) 745-1863-610 A6A1R45		1
	104	240-2711-300	2 COIL,RF, 27UH (V99800) 240-2711-300 A6A1L20		1
	105	8131-050-651-104 M	2 CAPACITOR,FXD, CER DIEI, 0.1UF, 20%, 50V (V72982) 913-3279-200 A6A1C3		1
	106	2C067103X0101A3	2 CAPACITOR,FXD, CER DIEI, 0.01UF, 20%, 100V (V56289) 913-4240-100 A6A1C55		1
	107	2C067102X0101A3	2 CAPACITOR,FXD, CER DIEI, 0.001UF, 20%, 100V (V56289) 913-4240-140 A6A1C9		1
	108	RCR05G220JS	2 RESISTOR,FXD, CMPSN, 22 OHMS, 5%, 1/8W (V81349) 745-1863-090 A6A1R7		1
	109	240-2711-300	2 COIL,RF, 27UH (V99800) 240-2711-300 A6A1L4		1
	110	2465-008W5T0102P	2 CAPACITOR,FXD, CER DIEI, 1000PF, GMV, 500V (V72982) 913-3208-000 A6A1C18		1
	111	MS75085-03	2 COIL,RF, 47UH (V96906) 240-2043-000 A6A1L6		1
	112	RCR05G682JS	2 RESISTOR,FXD, CMPSN, 6.8K, 5%, 1/8W (V81349) 745-1863-690 A6A1R11		1
	113	RCR05G821JS	2 RESISTOR,FXD, CMPSN, 820 OHMS, 5%, 1/8W (V81349) 745-1863-470 A6A1R33		1
	114	RCR05G100JS	2 RESISTOR,FXD, CMPSN, 10 OHMS, 5%, 1/8W (V81349) 745-1863-010 A6A1R13		1
	115	2C067103X0101A3	2 CAPACITOR,FXD, CER DIEI, 0.01UF, 20%, 100V (V56289) 913-4240-100 A6A1C14		1
	116	81118079C0G0-828 C	2 CAPACITOR,FXD, CER DIEI, 0.82PF, 0.25PF, 75V (V72982) 913-1098-290 A6A1C21		1
	117	FV2173	2 TRANSISTOR, (V17896) 352-0756-070 A6A1Q3		1
	118	RCR05G100JS	2 RESISTOR,FXD, CMPSN, 10 OHMS, 5%, 1/8W (V81349) 745-1863-010 A6A1R14		1
	119	D45F171J050WV	2 CAPACITOR,FXD, MICA DIEI, 170PF, 5%, 50V (V72136) 912-4141-420 A6A1C22		1
	120	145767	2 SEMICONV DEVICE, (V07688) 922-6119-010 A6A1CR7		1
	121	MS75085-03	2 COIL,RF, 47UH (V96906) 240-2043-000 A6A1L7		1
	122	2C067103X0101A3	2 CAPACITOR,FXD, CER DIEI, 0.01UF, 20%, 100V (V56289) 913-4240-100 A6A1C43		1
	123	240-2711-300	2 COIL,RF, 27UH (V99800) 240-2711-300 A6A1L9		1
	124	RCR05G331JS	2 RESISTOR,FXD, CMPSN, 330 OHMS, 5%, 1/8W (V81349) 745-1863-370 A6A1R15		1
	125	23TD21	2 RESISTOR,THRM, 270 OHMS, 10%, 3.8MW (V90634) 714-0007-030 A6A1RT1		1
	126	55D1820F	2 RESISTOR,FXD, FILM, 182 OHMS, 1%, 1/8W (V96214) 705-1469-590 A6A1R30		1
	127	2C067102X0101A3	2 CAPACITOR,FXD, CER DIEI, 0.001UF, 20%, 100V (V56289) 913-4240-140 A6A1C40		1
	128	2C067103X0101A3	2 CAPACITOR,FXD, CER DIEI, 0.01UF, 20%, 100V (V56289) 913-4240-100 A6A1C39		1
	129	2C067103X0101A3	2 CAPACITOR,FXD, CER DIEI, 0.01UF, 20%, 100V (V56289) 913-4240-100 A6A1C23		1
	130	MS75085-03	2 COIL,RF, 47UH (V96906) 240-2043-000 A6A1L5		1
	131	RCR05G100JS	2 RESISTOR,FXD, CMPSN, 10 OHMS, 5%, 1/8W (V81349) 745-1863-010 A6A1R9		1
	132	790-0260-001	2 TRANSFORMER, A6A1T3		1
	133	D45F151J050WV	2 CAPACITOR,FXD, MICA DIEI, 150PF, 5%, 50V (V72136) 912-4141-400 A6A1C35		1

GROUP ASSEMBLY PARTS LIST

FIG - ITEM	PART NO	INDENT	DESCRIPTION	USABLE ON CODE	UNITS PER ASSY
37 134	RCR05G332JS	2	RESISTOR,FXD, CMPSN, 3.3K, 5%, 1/8W (V81349) 745-1863-610 A6A1R8		1
135	2C067102X0101A3	2	CAPACITOR,FXD, CER DIEI, 0.001UF, 20%, 100V (V56289) 913-4240-140 A6A1C10		1
136	2465-008W5T0102P	2	CAPACITOR,FXD, CER DIEI, 1000PF, GMV, 500V (V72982) 913-3208-000 A6A1C42		1
137	790-0259-001	2	TRANSFORMER, A6A1T2		1
138	8131-050-651-104 M	2	CAPACITOR,FXD, CER DIEI, 0.1UF, 20%, 50V (V72982) 913-3279-200 A6A1C25		1
139	MS75084-12	2	COIL,RF, 10MH (V96906) 240-2035-000 A6A1L21		1
140	DM5F151J050WV	2	CAPACITOR,FXD, MICA DIEI, 150PF, 5%, 50V (V72136) 912-4141-400 A6A1C24		1
141	DM5E240D050WV	2	CAPACITOR,FXD, MICA DIEI, 24PF, 0.5PF, 50V (V72136) 912-4141-160 A6A1C44		1
142	RCR05G101JS	2	RESISTOR,FXD, CMPSN, 100 OHMS, 5%, 1/8W (V81349) 745-1863-250 A6A1R36		1
143	DM5F151J050WV	2	CAPACITOR,FXD, MICA DIEI, 150PF, 5%, 50V (V72136) 912-4141-400 A6A1C26		1
144	MS75084-12	2	COIL,RF, 10UH (V96906) 240-2035-000 A6A1L10		1
145	DM5F151J050WV	2	CAPACITOR,FXD, MICA DIEI, 150PF, 5%, 50V (V72136) 912-4141-400 A6A1C48		1
146	M39003-01-2029	2	CAPACITOR,FXD, ELCTLT, 3.3UF, 20%, 15V (V81349) 184-9083-290 A6A1C47		1
147	618-3255-001	2	TRANSFORMER, A6A1T7		1
148	DM5E240D050WV	2	CAPACITOR,FXD, MICA DIEI, 24PF, 0.5PF, 50V (V72136) 912-4141-160 A6A1C46		1
149	618-3254-001	2	SHIELD,RF		1
150	618-3253-002	2	SHIELD,RF		1
151	618-3253-001	2	SHIELD,RF		1
	330-1701-050	2	SCREW,SELF-LKG, SST, 2-56 X 7/16 (V72962) 330-1701-050 (AP FOR 149-151)		2
152	4040-2HT	2	TERMINAL,LUG, (V77147) 304-0014-000		1
	MS35649-224	2	NUT,PLAIN,HFX, SST, 2-56 (V96906) 313-0037-000 (AP)		1
	MS35333-69	2	WASHER,LOCK, SST, 0.095 ID X 0.185 OD (V96906) 373-8500-000 (AP)		1
	MS51957-3	2	SCREW,MACH, CD PL STL, 2-56 X 1/4 (V96906) 343-0124-000 (AP)		1
153	618-3407-001	2	SHIELD,RF		1
	MS51957-3	2	SCREW,MACH, CD PL STL, 2-56 X 1/4 (V96906) 343-0124-000 (AP)		3
	MS35333-69	2	WASHER,LOCK, SST, 0.095 ID X 0.185 OD (V96906) 373-8500-000 (AP)		3
154	618-3257-001	2	PLATE,CHASSIS, PRSD		1
155	T1533	3	HOLDER,XSTR, (V98291) 352-9509-000		1
156	SL441-434WHT	3	TERMINAL,STUD, (V12615) 306-2222-100		53
157	M5-540-3	3	TERMINAL,FEEDTH, (V12615) 306-2608-050		7
158	SL354-351WHT	3	TERMINAL,FEEDTH, (V12615) 306-2474-010		23
159	011-6809	3	TERMINAL,FEEDTH, (V98291) 306-2297-000		4
160	M2-542-3	3	TERMINAL,FEEDTH, (V12615) 306-2608-060		10
161	R22NCFMA1-26	3	NUT,SLFLKG, CD PL STL, 2-56 (V72962) 333-0837-000		4
162	618-3256-001	3	PLATE,RF MIXER		1
38 -	618-7678-001	1	SWITCH ASSY, FILTER/DIODE A6A2 (SEE FIG 36-23 FOR NHA)	BZ	RF
	618-7678-002	1	SWITCH ASSY, FILTER/DIODE A6A2 (SEE FIG 36-23 FOR NHA)	CA	RF



GROUP ASSEMBLY PARTS LIST

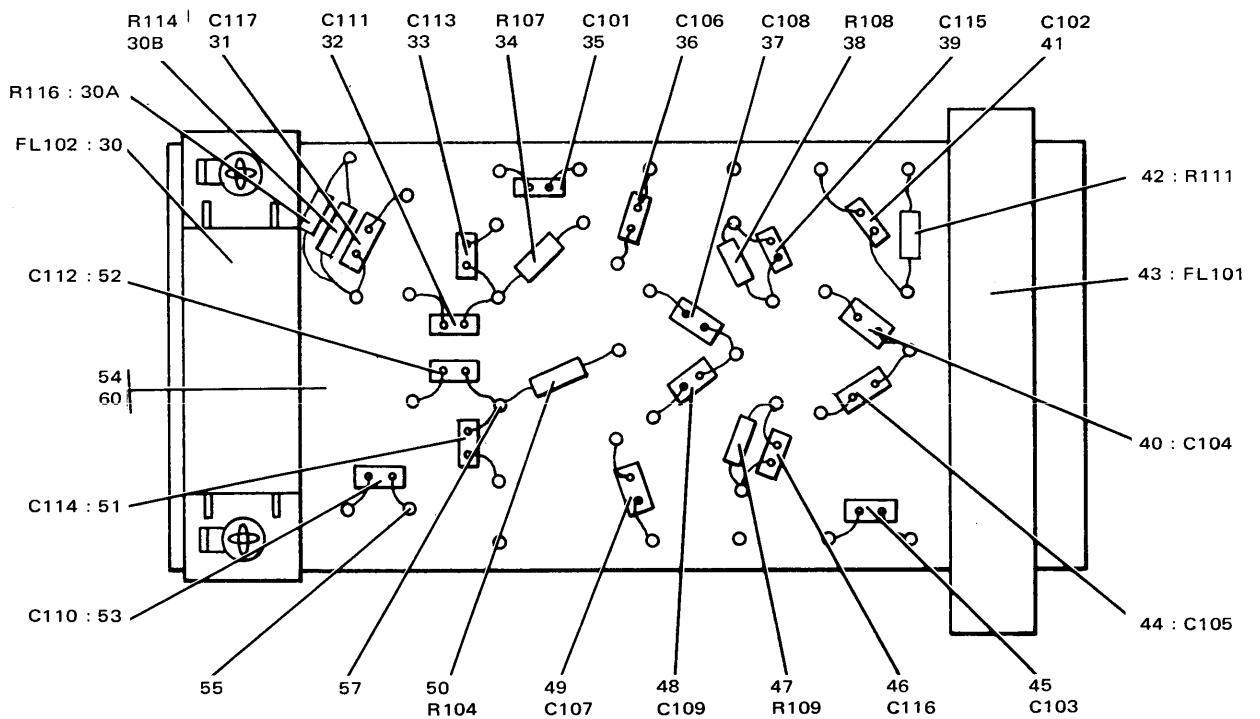
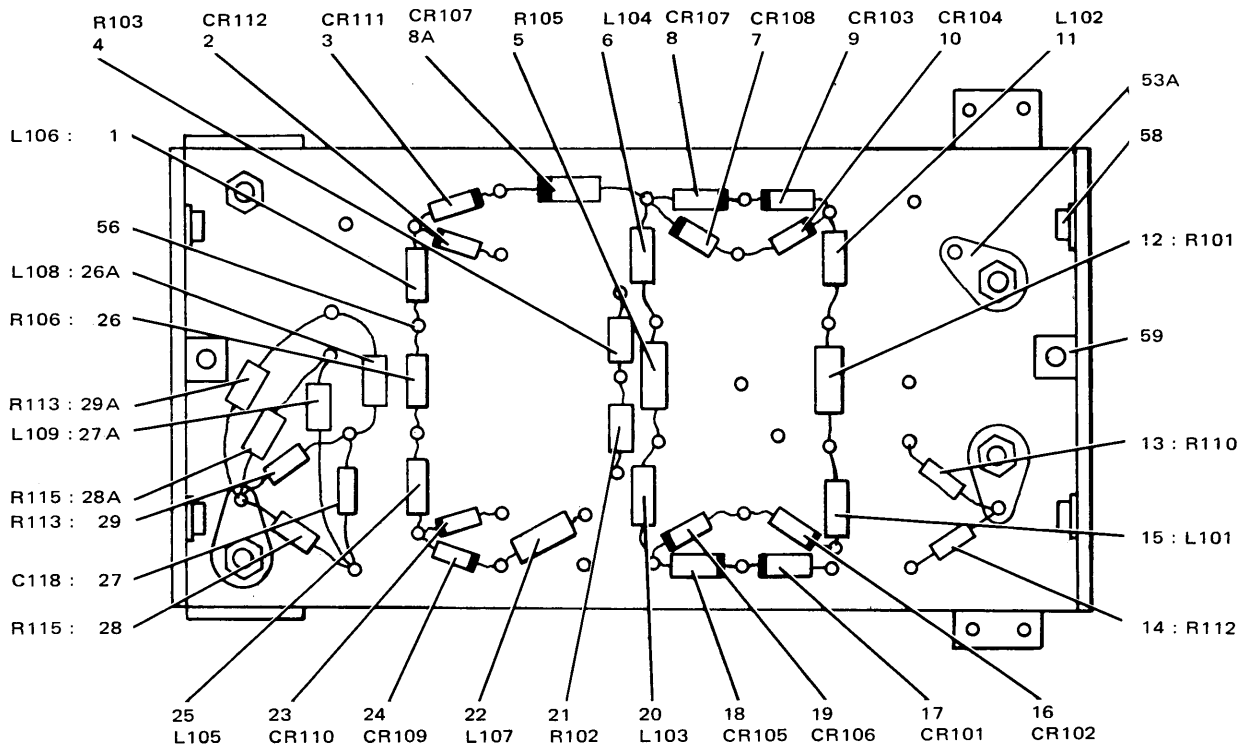

TP3-2234-019

Filter/Diode Switch Assembly (A6A2) 618-7678-001, -002  
Figure 38

GROUP ASSEMBLY PARTS LIST

FIG - ITEM	PART NO	INDENT	DESCRIPTION	USABLE ON CODE	UNITS PER ASSY
38	1 MS90538-06	2	COIL,RF, 56UH (V96906) 240-2510-000 A6A2L106		1
	2 1N458	2	SEMICONV DEVICE, (V07688) 353-0205-000 A6A2CR112		1
	3 1N458	2	SEMICONV DEVICE, (V07688) 353-0205-000 A6A2CR111		1
	4 RCR07G180KS	2	RESISTOR,FXD, CMPSN, 18 OHMS, 10%, 1/4W (V81349) BZ 745-0686-000 A6A2R103 (EFF TO CI 72443)		1
	4 RCR20G120KS	2	RESISTOR,FXD, CMPSN, 12 OHMS, 10%, 1/2W (V81349) BZ 745-1272-000 A6A2R103 (EFF CI 72443)		1
	4 RCR20G120KS	2	RESISTOR,FXD, CMPSN, 12 OHMS, 10%, 1/2W (V81349) CA 745-1272-000 A6A2R103		1
	5 RCR20G820KS	2	RESISTOR,FXD, CMPSN, 82 OHMS, 10%, 1/2W (V81349) 745-1307-000 A6A2R105		1
	6 MS90538-20	2	COIL,RF, 220UH (V96906) 240-2524-000 A6A2L104		1
	7 1N458	2	SEMICONV DEVICE, (V07688) 353-0205-000 A6A2CR108		1
	8 1N458	2	SEMICONV DEVICE, (V07688) 353-0205-000 A6A2CR107 BZ (EFF TO CI 72443)		1
	8A 1N458	2	SEMICONV DEVICE, (V07688) 353-0205-000 A6A2CR107 BZ (EFF CI 72443)		1
	8A 1N458	2	SEMICONV DEVICE, (V07688) 353-0205-000 A6A2CR107 CA		1
	9 1N458	2	SEMICONV DEVICE, (V07688) 353-0205-000 A6A2CR103		1
	10 1N458	2	SEMICONV DEVICE, (V07688) 353-0205-000 A6A2CR104		1
	11 MS90538-20	2	COIL,RF, 220UH (V96906) 240-2524-000 A6A2L102		1
	12 RCR20G820KS	2	RESISTOR,FXD, CMPSN, 82 OHMS, 10%, 1/2W (V81349) 745-1307-000 A6A2R101		1
	13 RCR20G151KS	2	RESISTOR,FXD, CMPSN, 150 OHMS, 10%, 1/2W (V81349) 745-1317-000 A6A2R110 (EFF TO CI 72443)	BZ	1
	14 RCR20G151KS	2	RESISTOR,FXD, CMPSN, 150 OHMS, 10%, 1/2W (V81349) 745-1317-000 A6A2R112 (EFF TO CI 72443)	BZ	1
	15 MS90538-20	2	COIL,RF, 220UH (V96906) 240-2524-000 A6A2L101		1
	16 1N458	2	SEMICONV DEVICE, (V07688) 353-0205-000 A6A2CR102 BZ		1
	17 1N458	2	SEMICONV DEVICE, (V07688) 353-0205-000 A6A2CR101 BZ		1
	18 1N458	2	SEMICONV DEVICE, (V07688) 353-0205-000 A6A2CR105		1
	19 1N458	2	SEMICONV DEVICE, (V07688) 353-0205-000 A6A2CR106		1
	20 MS90538-20	2	COIL,RF, 220UH (V96906) 240-2524-000 A6A2L103		1
	21 RCR07G180KS	2	RESISTOR,FXD, CMPSN, 18 OHMS, 10%, 1/4W (V81349) BZ 745-0686-000 A6A2R102 (EFF TO CI 72443)		1
	21 RCR20G120KS	2	RESISTOR,FXD, CMPSN, 12 OHMS, 10%, 1/2W (V81349) BZ 745-1272-000 A6A2R102 (EFF CI 72443)		1
	21 RCR20G120KS	2	RESISTOR,FXD, CMPSN, 12 OHMS, 10%, 1/2W (V81349) CA 745-1272-000 A6A2R102		1
	22 MS90538-20	2	COIL,RF, 220UH (V96906) 240-2524-000 A6A2L107		1
	23 1N458	2	SEMICONV DEVICE, (V07688) 353-0205-000 A6A2CR110		1
	24 1N458	2	SEMICONV DEVICE, (V07688) 353-0205-000 A6A2CR109		1
	25 MS90538-06	2	COIL,RF, 56UH (V96906) 240-2510-000 A6A2L105		1
	26 RCR20G820KS	2	RESISTOR,FXD, CMPSN, 82 OHMS, 10%, 1/2W (V81349) 745-1307-000 A6A2R106		1
	26A LT4K036	2	COIL,RF, 1.5UH (V81349) 240-0063-000 A6A2L108 (EFF CI 73045)		1
	27 RCR20G390KS	2	RESISTOR,FXD, CMPSN, 39 OHMS, 10%, 1/2W (V81349) BZ 745-1293-000 A6A2R114 (EFF TO CI 72443)		1
	27 CM05FD391J03	2	CAPACITOR,FXD, MICA DIEI, 390PF, 5%, 500V (V81349) 912-2858-000 A6A2C118 (EFF CI 72443 TO CI 73045)	BZ	1
	27 CM05FD391J03	2	CAPACITOR,FXD, MICA DIEI, 390PF, 5%, 500V (V81349) 912-2858-000 (EFF TO CI 73045)	CA	1
	27 CM05FD301J03	2	CAPACITOR,FXD, MICA DIEI, 300PF, 5%, 500V (V81349) 912-2849-000 (EFF CI 73045)		1
	27A LT4K036	2	COIL,RF, 1.5UH (V81349) 240-0063-000 (EFF CI 73045)		1
	28 RN65D2150F	2	RESISTOR,FXD, FILM, 215 OHMS, 1%, 1/2W (V81349) 705-7064-000 A6A2R115 (EFF TO CI 73045)		1
	28A RN65D2150F	2	RESISTOR,FXD, FILM, 215 OHMS, 1%, 1/2W (V81349) 705-7064-000 A6A2R115 (EFF CI 73045)		1
	29 RN65D2150F	2	RESISTOR,FXD, FILM, 215 OHMS, 1%, 1/2W (V81349) 705-7064-000 A6A2R113 (EFF TO CI 73045)		1

## GROUP ASSEMBLY PARTS LIST

FIG - ITEM	PART NO	INDENT	DESCRIPTION	USABLE ON CODE	UNITS PER ASSY
38	29A RN65D2150F	2	RESISTOR,FXD, FILM, 215 OHMS, 1%, 1/2W (V81349) 705-7064-000 A6A2R113 (EFF CI 73045)		1
	30 A259	2	FILTER,LOWPASS, (V81815) 241-0618-010 A6A2FL102		1
	P313-0132-000	2	NUT,PLAIN,HEX, SST, 4-40 (V77250) 313-0132-000 (AP)		2
	MS35338-97	2	WASHER,LOCK, BRZ, 0.115 ID X 0.212 OD (V96906) 310-0076-000 (AP)		2
	4007-4HT	2	TERMINAL,LUG, (V77147) 304-0015-000 (AP)		2
	2104-04-01-2520N	2	TERMINAL,LUG, (V78189) 304-0317-000 (AP)		1
	MS51957-13	2	SCREW,MACH, STL, 4-40 X 1/4 (V96906) 343-0133-000 (AP)		1
	30A RN65D46R4F	2	RESISTOR,FXD, FILM, 46.4 OHMS, 1%, 1/2W (V81349) BZ 705-7032-000 A6A2R115 (EFF CI 72443)		1
	30A RN65D46R4F	2	RESISTOR,FXD, FILM, 46.4 OHMS, 1%, 1/2W (V81349) CA 705-7032-000 A6A2R115		1
	30B RN65D46R4F	2	RESISTOR,FXD, FILM, 46.4 OHMS, 1%, 1/2W (V81349) BZ 705-7032-000 A6A2R114 (EFF CI 72443)		1
	31 8131-050-651-104	2	CAPACITOR,FXD, CER DIE, 0.1UF, 20%, 50V (V72982) 913-3279-200 A6A2C117		1
	M				
	32 8131-050-651-104	2	CAPACITOR,FXD, CER DIE, 0.1UF, 20%, 50V (V72982) 913-3279-200 A6A2C111		1
	M				
	33 2C067103X0101A3	2	CAPACITOR,FXD, CER DIE, 0.01UF, 20%, 100V (V56289) 913-4240-100 A6A2C113		1
	34 RCR20G820KS	2	RESISTOR,FXD, CMPSN, 82 OHMS, 10%, 1/2W (V81349) 745-1307-000 A6A2R107		1
	35 8131-050-651-104	2	CAPACITOR,FXD, CER DIE, 0.1UF, 20%, 50V (V72982) 913-3279-200 A6A2C101		1
	M				
	36 8131-050-651-104	2	CAPACITOR,FXD, CER DIE, 0.1UF, 20%, 50V (V72982) 913-3279-200 A6A2C106		1
	M				
	37 8131-050-651-104	2	CAPACITOR,FXD, CER DIE, 0.1UF, 20%, 50V (V72982) 913-3279-200 A6A2C108		1
	M				
	38 RCR07G102KS	2	RESISTOR,FXD, CMPSN, 1K, 10%, 1/4W (V81349) 745-0749-000 A6A2R108		1
	39 2C067103X0101A3	2	CAPACITOR,FXD, CER DIE, 0.01UF, 20%, 100V (V56289) 913-4240-100 A6A2C115		1
	40 8131-050-651-104	2	CAPACITOR,FXD, CER DIE, 0.1UF, 20%, 50V (V72982) 913-3279-200 A6A2C104		1
	M				
	41 8131-050-651-104	2	CAPACITOR,FXD, CER DIE, 0.1UF, 20%, 50V (V72982) 913-3279-200 A6A2C102	BZ	1
	M				
	42 RCR20G390KS	2	RESISTOR,FXD, CMPSN, 39 OHMS, 10%, 1/2W (V81349) BZ 745-1293-000 A6A2R111 (EFF TO CI 72443)		1
	43 A275	2	FILTER,LP, (V81815) 241-0685-010 A6A2FL101	BZ	1
	P313-0132-000	2	NUT,PLAIN,HEX, SST, 4-40 (V77250) 313-0132-000 (AP)	BZ	2
	MS35338-97	2	WASHER,LOCK, BRZ, 0.115 ID X 0.212 OD (V96906) 310-0076-000 (AP)	BZ	1
	2104-04-01-2520N	2	TERMINAL,LUG, (V78189) 304-0317-000 (AP) (EFF TO CI 72443)	BZ	1
	44 2C067103X0101A3	2	CAPACITOR,FXD, CER DIE, 0.01UF, 20%, 100V (V56289) 913-4240-100 A6A2C105		1
	45 8131-050-651-104	2	CAPACITOR,FXD, CER DIE, 0.1UF, 20%, 50V (V72982) 913-3279-200 A6A2C103		1
	M				
	46 2C067103X0101A3	2	CAPACITOR,FXD, CER DIE, 0.01UF, 20%, 100V (V56289) 913-4240-100 A6A2C116		1
	47 RCR07G102KS	2	RESISTOR,FXD, CMPSN, 1K, 10%, 1/4W (V81349) 745-0749-000 A6A2R109		1
	48 2C067103X0101A3	2	CAPACITOR,FXD, CER DIE, 0.01UF, 20%, 100V (V56289) 913-4240-100 A6A2C109		1
	49 8131-050-651-104	2	CAPACITOR,FXD, CER DIE, 0.1UF, 20%, 50V (V72982) 913-3279-200 A6A2C107		1
	M				
	50 RCR20G680KS	2	RESISTOR,FXD, CMPSN, 68 OHMS, 10%, 1/2W (V81349) BZ 745-1303-000 A6A2R104 (EFF TO CI 72443)		1

GROUP ASSEMBLY PARTS LIST

FIG - ITEM	PART NO	INDENT	DESCRIPTION	USABLE ON CODE	UNITS PER ASSY
38	50	RCR20G101KS	2 RESISTOR,FXD, CMPSN, 100 OHMS, 10%, 1/2W (V81749) 745-1310-000 A6A2R104 (EFF CI 72443)	BZ	1
	50	RCR20G101KS	2 RESISTOR,FXD, CMPSN, 100 OHMS, 10%, 1/2W (V81749) 745-1310-000 A6A2R104	CA	1
	51	2C067103X0101A3	2 CAPACITOR,FXD, CER DIEL, 0.01UF, 20%, 100V (V56289) 913-4240-100 A6A2C114		1
	52	2C067103X0101A3	2 CAPACITOR,FXD, CER DIEL, 0.01UF, 20%, 100V (V56289) 913-4240-100 A6A2C112		1
	53	8131-050-651-104 M	2 CAPACITOR,FXD, CER DIEL, 0.1UF, 20%, 50V (V72982) 913-3279-200 A6A2C110		1
	53A	2104-04-01-2520N	2 TERMINAL,LUG, (V78189) 304-0317-000	CA	1
		P313-0132-000	2 NUT,PLAIN,HEX, SST, 4-40 (V77250) 313-0132-000 (AP)	CA	1
		MS35338-97	2 WASHER,LOCK, BRZ, 0.115 ID X 0.212 OD (V96906) 310-0076-000 (AP)	CA	1
		MS51957-13	2 SCREW,MACH, STL, 4-40 X 1/4 (V96906) 343-0133-000 (AP)	CA	1
	54	618-7677-001	2 BRACKET, FILTER, PRSD		1
	55	SL441-434WHT	3 TERMINAL,STUD, (V12615) 306-2222-100 (EFF TO CI 72424)		2
	55	SL441-434WHT	3 TERMINAL,STUD, (V12615) 306-2222-100 (EFF CI 72424)		1
	56	SL354-351WHT	3 TERMINAL,FEEDTH, (V12615) 306-2474-010 (EFF TO CI 72424)		29
	56	SL354-351WHT	3 TERMINAL,FEEDTH, (V12615) 306-2474-010 (EFF CI 72424 TO CI 73045)		30
	56	SL354-351WHT	3 TERMINAL,FEEDTH, (V12615) 306-2474-010 (EFF CI 73045)		32
	57	42-542-3	3 TERMINAL,FEEDTH, (V12615) 306-2608-060 (EFF TO CI 72443)		6
	57	42-542-3	3 TERMINAL,FEEDTH, (V12615) 306-2608-060 (EFF CI 72443)		7
	58	F22NCFMA2-40	3 NUT,SLFLKG, CD PL STL, 4-40 (V72962) 333-0840-000		4
	59	609-1638-001	3 FASTENER, ANGLE		2
	60	618-7677-002	3 BRACKET, FILTER		1
39	-	606-9425-003	1 PANEL ASSY, FRONT (SEE FIG 26-13 FOR NHA)	CB	RF
	-	606-9425-004	1 PANEL ASSY, FRONT (SEE FIG 26-13 FOR NHA)	CC	RF
	-	606-9425-005	1 PANEL ASSY, FRONT (SEE FIG 26-13 FOR NHA)	CD	RF
	1	458-0840-010	2 AMMETER,DC, (V32171) 458-0840-010 M101		1
	2	609-0565-001	2 CLAMP, METER		2
		P343-0298-000	2 SCREW,MACH, NP BR, 2-56 X 3/16 (V77250) 343-0298-000 (AP FOR 1,2)		4
		310-0070-000	2 WASHER,LOCK, SST, 0.097 ID X 0.165 OD (V79807) 310-0070-000 (AP FOR 1,2)		4
	3	609-0554-001	2 BRACKET		1
	4	606-9403-001	2 MOUNT, METER		2
		P343-0298-000	2 SCREW,MACH, NP BR, 2-56 X 3/16 (V77250) 343-0298-000 (AP FOR 3,4)		4
	5	606-9705-001	2 METER ASSY	CB,CC	1
	5	606-9705-002	2 METER ASSY	CD	1
		MS51959-14	2 SCREW,MACH, SST, 4-40 X 5/16 (V96906) 342-0045-000 (AP)		1
		MS51959-3	2 SCREW,MACH, SST, 2-56 X 1/4 (V96906) 342-0133-000 (AP)		1

GROUP ASSEMBLY PARTS LIST

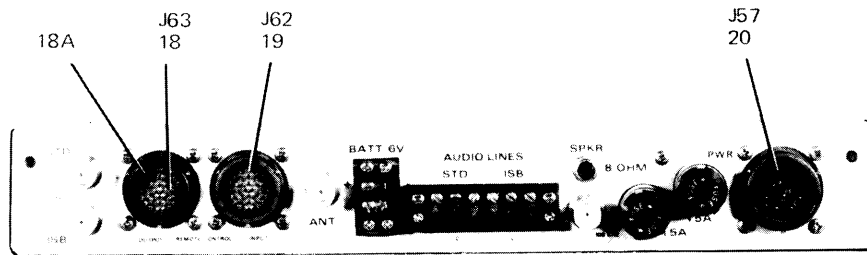
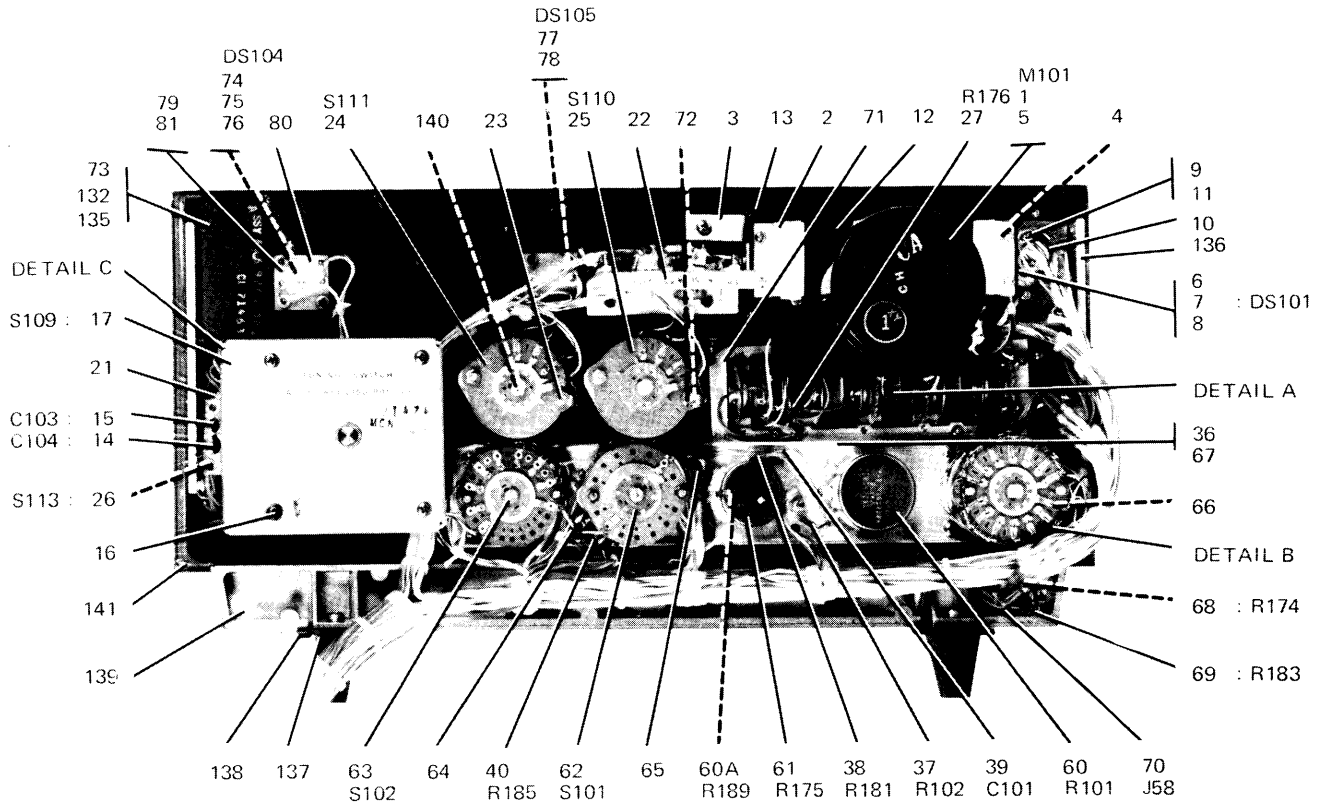

TP3-2266-037

Front Panel Assembly 606-9425-003, -004, -005  
Figure 39 (Sheet 1 of 3)

GROUP ASSEMBLY PARTS LIST

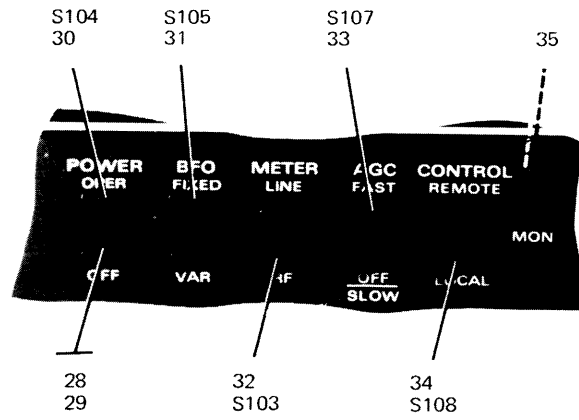

DETAIL A

DETAIL B

TOP VIEW

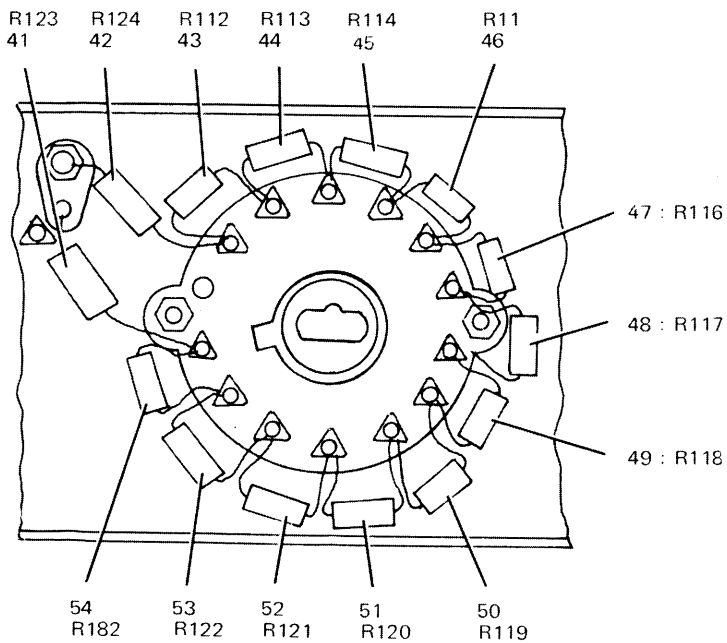

SIDE VIEW

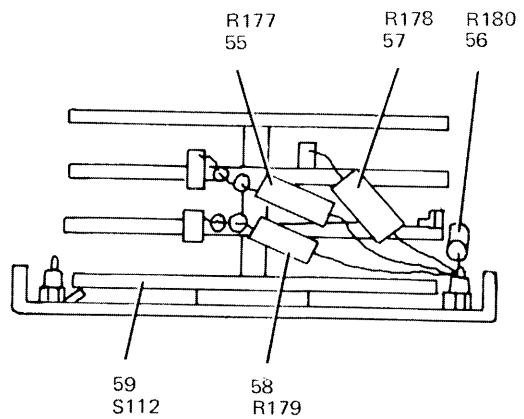

TP3-2266-037

Front Panel Assembly 606-9425-003, -004, -005  
Figure 39 (Sheet 2 of 3)

GROUP ASSEMBLY PARTS LIST

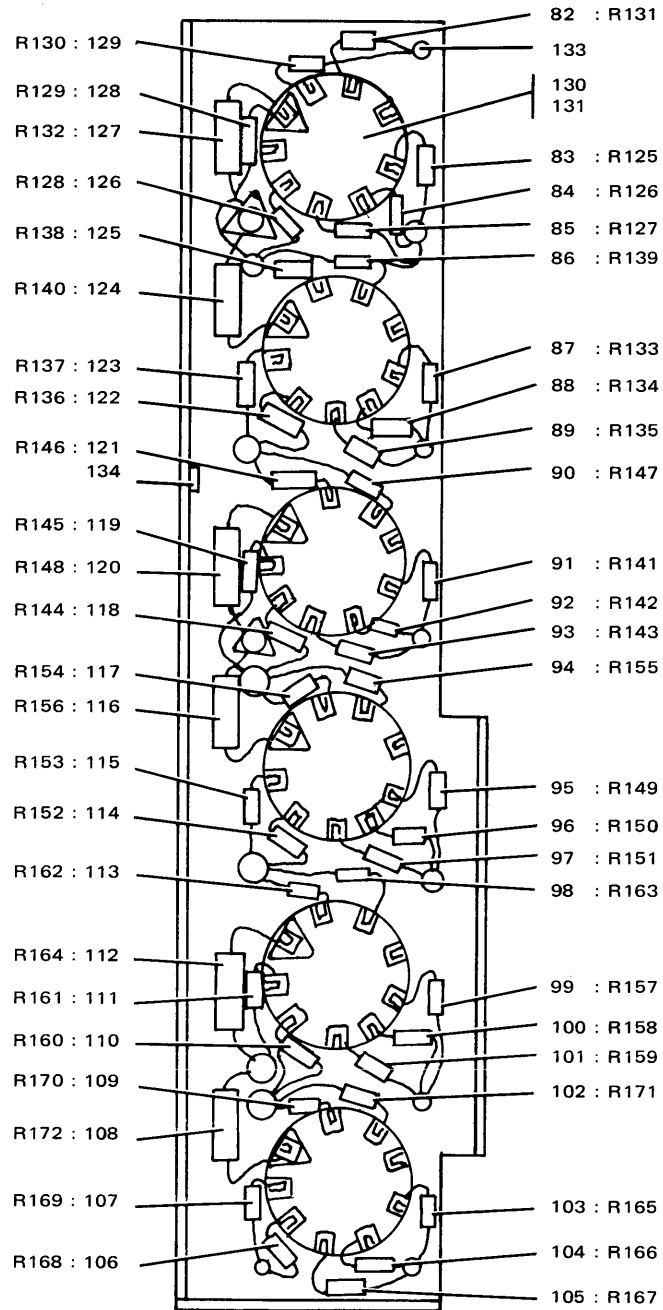

DETAIL C

TP3-2266-037

Front Panel Assembly 606-9425-003, -004, -005  
Figure 39 (Sheet 3 of 3)

GROUP ASSEMBLY PARTS LIST

FIG - ITEM	PART NO	INDENT	DESCRIPTION	USABLE ON CODE	UNITS PER ASSY
39	MS51957-13	2	SCREW, MACH, STL, 4-40 X 1/4 (V96906) 343-0133-000 (AP)		1
6	102203R	3	LIGHT, IND, (V08717) 262-1887-000	CB,CC	1
7	MS24515-685	3	LAMP, INCAND, (V96906) 262-0934-000 DS101	CB,CC	1
8	102SRIH23HI AV936A416B	3	LIGHT, IND, (V08817) 262-2185-030	CB,CC	1
	310-0061-000	3	WASHER, LOCK, CD PL BRZ, 0.267 ID X 0.478 OD (V88044) 373-3050-000 (AP)	CB,CC	1
	310-0061-000	3	WASHER, FLAT, BRS, 0.265 ID X 0.625 OD (V79807) 310-0061-000 (AP)	CB,CC	1
9	606-9717-001	3	HOLDER, SOCKET		1
	P343-0298-000	3	SCREW, MACH, NP BRS, 2-56 X 3/16 (V77250) 343-0298-000 (AP)		2
10	SL157-197	4	TERMINAL, STDF, (V12615) 306-1260-000		4
11	606-9408-001	4	HOLDER		1
12	609-0919-001	3	POST		5
	P347-0022-000	3	SCREW, MACH, SST, 2-56 X 1/4 (V77250) 347-0022-000 (AP)		5
13	606-9720-001	3	BRACKET, METER		1
14	2C067102X0101A3	2	CAPACITOR, FXD, CER DIEL, 0.001UF, 20%, 100V (V56289) 913-4240-140 C104 (EFF TO CI 72496)	CC	1
15	2C067102X0101A3	2	CAPACITOR, FXD, CER DIEL, 0.001UF, 20%, 100V (V56289) 913-4240-140 C103 (EFF TO CI 72496)	CC	1
16	2104-04-01-2520N	2	TERMINAL, LUG, (V78189) 304-0317-000		1
17	610-2150-001	2	SWITCH ASSY, DRUM, SEQUENTIAL S109		1
	540-9059-003	2	POST, (AP)		4
	MS51959-13	2	SCREW, MACH, SST, 4-40 X 1/4 (V96906) 342-0044-000 (AP)		4
	609-0553-002	2	WIRING HARNESS	CB	1
	609-0553-003	2	WIRING HARNESS	CC	1
	609-0553-004	2	WIRING HARNESS	CD	1
18	JT02A14-37PA014	3	CONNECTOR, RCPT, ELEC (V77820) 371-9009-020 J63	CD	1
18A	SS51149CDPL	2	BUTTON, PL, (V83058) 308-0055-000		1
19	JT02A14-37P014	3	CONNECTOR, RCPT, ELEC (V77820) 371-9009-010 J62		1
20	PT02A16-8P 68NM40	3	CONNECTOR, RCPT, ELEC (V77820) 371-2071-000 J57		1
	68NM40	3	NUT, SLFLKG, HEX, AL, 4-40 (V72962) 333-0347-000 (AP FOR 18-20)	CB,CC	12
	68NM40	3	NUT, SLFLKG, HEX, AL, 4-40 (V72962) 333-0347-000 (AP FOR 19,20)	CD	8
	2104-04-01-2520N	3	TERMINAL, LUG, (V78189) 304-0317-000 (AP FOR 20)		1
	MS51957-14	3	SCREW, MACH, STL, 4-40 X 5/16 (V96906) 343-0134-000 (AP FOR 18-20)	CB,CC	11
	MS51957-14	3	SCREW, MACH, STL, 4-40 X 5/16 (V96906) 343-0134-000 (AP FOR 19,20)	CD	7
	MS51957-15	3	SCREW, MACH, STL, 4-40 X 3/8 (V96906) 343-0135-000 (AP FOR 20)		1
21	425-1494-000	3	CABLE, RF, (V90484) 425-1494-000		AR
22	609-0928-001	2	SWITCH, POWER, KEEP ALIVE (SEE FIG 27)	CB,CC	1
	MS35649-224	2	NUT, PLAIN, HEX, SST, 2-56 (V96906) 313-0037-000 (AP)	CB,CC	2
	P347-1269-000	2	SCREW, MACH, SST, 2-56 X 5/16 (V77250) 347-1269-000 (AP)	CB,CC	2
23	4040-5HDSPL	2	TERMINAL, LUG, (V77147) 304-0332-000		2
	P313-0132-000	2	NUT, PLAIN, HEX, SST, 4-40 (V77250) 313-0132-000 (AP)		2
	310-0278-000	2	WASHER, LOCK, SST, 0.115 ID X 0.202 OD (V70318) 310-0278-000 (AP)		2
24	39352-48LR1	2	SWITCH, ROTARY, (V82104) 259-2863-010 S111		1
25	39352-48LR1	2	SWITCH, ROTARY, (V82104) 259-2863-010 S110		1
	P334-4060-000	2	NUT, PLAIN, HEX, NP BRS 3/8-32 (V77250) 334-4060-000 (AP FOR 24,25)		2
	1220-02	2	WASHER, LOCK, CD PL STL, 0.391 ID X 0.507 OD (V78189) 373-0081-000 (AP FOR 24,25)		2
26	G111SPDT	2	SWITCH, SLIDE, (V79727) 266-0216-010 S113		1



## GROUP ASSEMBLY PARTS LIST

FIG - ITEM	PART NO	INDENT	DESCRIPTION	USABLE ON CODE	UNITS PER ASSY
39	68-1660-26	2	NUT, SLFLKG, HEX, AL, 2-56 (V72962) 333-0604-000 (AP)		2
	P342-0142-000	2	SCREW, MACH, NP RRS, 2-56 X 3/16 (V77250) 342-0142-000 (AP)		2
27	RCR07G101KS	2	RESISTOR, FXD, CMPSN, 100 OHMS, 10%, 1/4W (V81349) 745-0713-000 R176		1
28	606-9706-002	2	SWITCH ASSY, TOGGLE		1
	P343-0299-000	2	SCREW, MACH, NP RRS, 2-56 X 1/4 (V77250) 343-0299-000 (AP)		2
	310-0075-000	2	WASHER, LOCK, BRZ, 0.088 ID X 0.165 OD (V79807) 310-0075-000 (AP)		2
	310-6320-000	2	WASHER, FLAT, SST, 0.092 ID X 0.218 OD (V79807) 310-6320-000 (AP)		2
29	606-9029-002	3	KNOR, SWITCH		5
30	38423SMLR	3	SWITCH, LEVER, (V82104) 259-2849-010 S104		1
31	38425SMLR	3	SWITCH, LEVER, (V82104) 259-2849-030 S105		1
32	38425SMLR	3	SWITCH, LEVER, (V82104) 259-2849-030 S103		1
33	38422SMLR	3	SWITCH, LEVER, (V82104) 259-2849-020 S107		1
34	38424SMLR	3	SWITCH, LEVER, (V82104) 259-2849-040 S108		1
	P330-2284-000	3	SCREW, MACH, SST, 2-56 X 3/16 (V77250) 330-2284-000 (AP FOR 30-34)		10
35	609-0932-001	3	PLATE, MOUNTING, SWITCH		1
36	606-9710-003	2	COMPONENT ASSY, RESISTOR	CB, CN	1
36	606-9710-004	2	COMPONENT ASSY, RESISTOR	CC	1
	540-9038-003	2	POST, (AP)		6
	MS35338-135	2	WASHER, LOCK, SST, 0.115 ID X 0.209 OD (V96906) 310-0279-000 (AP)		6
	MS51957-13	2	SCREW, MACH, STL, 4-40 X 1/4 (V96906) 343-0133-000 (AP)		6
	MS51959-13	2	SCREW, MACH, SST, 4-40 X 1/4 (V96906) 342-0044-000 (AP)		6
37	T055-61-9-1F	3	RESISTOR, FXD, FILM, 61.9 OHMS, 1%, 1/8W (V11502) 705-1454-100 R102 (EFF TO CI 72163)	CB, CN	1
37	T055-619-1F	3	RESISTOR, FXD, FILM, 619 OHMS, 1%, 1/8W (V11502) 705-1454-340 R102 (EFF CI 72163)	CB, CN	1
37	T055-61-9-1F	3	RESISTOR, FXD, FILM, 61.9 OHMS, 1%, 1/8W (V11502) 705-1454-100 R102 (EFF TO CI 72204)	CC	1
37	T055-619-1F	3	RESISTOR, FXD, FILM, 619 OHMS, 1%, 1/8W (V11502) 705-1454-340 R102 (EFF CI 72204)	CC	1
38	55D80R6F	3	RESISTOR, FXD, FILM, 76.8 OHMS, 1%, 1/8W (V96214) 705-1469-420 R181 (EFF TO CI 72163)	CB, CN	1
38	55D8060F	3	RESISTOR, FXD, FILM, 806 OHMS, 1%, 1/8W (V96214) 705-1469-890 R181 (EFF CI 72163)	CB, CN	1
38	55D80R6F	3	RESISTOR, FXD, FILM, 76.8 OHMS, 1%, 1/8W (V96214) 705-1469-420 R181 (EFF TO CI 72204)	CC	1
38	55D8060F	3	RESISTOR, FXD, FILM, 806 OHMS, 1%, 1/8W (V96214) 705-1469-890 R181 (EFF CI 72204)	CC	1
39	M39003-01-2050	3	CAPACITOR, FXD, ELCTLT, 15UF, 20%, 20V (V81349) 184-9083-500 C101		1
40	RCR32G470KS	3	RESISTOR, FXD, CMPSN, 47 OHMS, 10%, 1W (V81349) 745-3296-000 R185		1
41	55D2100F	3	RESISTOR, FXD, FILM, 210 OHMS, 1%, 1/8W (V96214) 705-1469-620 R123		1
42	55D2210F	3	RESISTOR, FXD, FILM, 221 OHMS, 1%, 1/8W (V96214) 705-1469-630 R124		1
43	55D47R5F	3	RESISTOR, FXD, FILM, 47.5 OHMS, 1%, 1/8W (V96214) 705-1469-310 R112		1
44	55D47R5F	3	RESISTOR, FXD, FILM, 47.5 OHMS, 1%, 1/8W (V96214) 705-1469-310 R113		1
45	55D47R5F	3	RESISTOR, FXD, FILM, 47.5 OHMS, 1%, 1/8W (V96214) 705-1469-310 R114		1
46	55D47R5F	3	RESISTOR, FXD, FILM, 47.5 OHMS, 1%, 1/8W (V96214) 705-1469-310 R115		1

GROUP ASSEMBLY PARTS LIST

FIG - ITEM	PART NO	INDENT	DESCRIPTION	USABLE ON CODE	UNITS PER ASSY
39 47	55D47R5F	3	RESISTOR,FXD, FILM, 47.5 OHMS, 1%, 1/8W (V96214) 705-1469-310 R116		1
48	55D47R5F	3	RESISTOR,FXD, FILM, 47.5 OHMS, 1%, 1/8W (V96214) 705-1469-310 R117		1
49	55D47R5F	3	RESISTOR,FXD, FILM, 47.5 OHMS, 1%, 1/8W (V96214) 705-1469-310 R118		1
50	55D47R5F	3	RESISTOR,FXD, FILM, 47.5 OHMS, 1%, 1/8W (V96214) 705-1469-310 R119		1
51	55D47R5F	3	RESISTOR,FXD, FILM, 47.5 OHMS, 1%, 1/8W (V96214) 705-1469-310 R120		1
52	55D47R5F	3	RESISTOR,FXD, FILM, 47.5 OHMS, 1%, 1/8W (V96214) 705-1469-310 R121		1
53	55D47R5F	3	RESISTOR,FXD, FILM, 47.5 OHMS, 1%, 1/8W (V96214) 705-1469-310 R122		1
54	55D47R5F	3	RESISTOR,FXD, FILM, 47.5 OHMS, 1%, 1/8W (V96214) 705-1469-310 R182		1
55	RCR05G822JS	3	RESISTOR,FXD, CMPSN, 8.2K, 5%, 1/8W (V81349) 745-1863-710 R177		1
56	RCR05G822JS	3	RESISTOR,FXD, CMPSN, 8.2K, 5%, 1/8W (V81349) 745-1863-710 R180		1
57	RCR05G822JS	3	RESISTOR,FXD, CMPSN, 8.2K, 5%, 1/8W (V81349) 745-1863-710 R178		1
58	RCR05G822JS	3	RESISTOR,FXD, CMPSN, 8.2K, 5%, 1/8W (V81349) 745-1863-710 R179		1
59	276805CK3	3	SWITCH,RTRY, (V76854) 259-2840-040 S112		1
60	RA20SASD252A	3	RESISTOR,VAR,WW, 2.5K, 10%, 2W (V81349) 750-0541-000 R101		1
60A	RCR05G223K	3	RESISTOR,FXD, CMPSN, 22K, 10%, 1/8W (V81349) 745-2389-000 R189 (EFF CI 72204)	CC	1
61	RV2NAYS103D	3	RESISTOR,VAR, 10K, 20%, 1/2W (V81349) 380-2517-000 R175	CB,CN	1
61	BA178003	3	RESISTOR,VAR, 10K TO 25K, 20%, 1/2W (V71590) 380-1090-010 R175	CC	1
62	280100K2	3	SWITCH,RTRY, (V76854) 259-2860-040 S101		1
63	280103K1	3	SWITCH,RTRY, (V76854) 259-2860-050 S102		1
	P334-4060-000	3	NUT,PLAIN,HEX, NP BRS 3/8-32 (V77250) 334-4060-000 (AP FOR 59-63)	CB,CN	5
	P334-4060-000	3	NUT,PLAIN,HEX, NP BRS 3/8-32 (V77250) 334-4060-000 (AP FOR 59-63)	CC	4
	P334-0287-00	3	NUT,PLAIN,HEX, SST, 1/4-32 (V77250) 334-0287-000 (AP FOR 59-63)	CC	1
	1220-02	3	WASHER,LOCK, CD PL STL, 0.391 ID X 0.507 OD (V78189) 373-0081-000 (AP FOR 59-63)	CB,CN	5
	1220-02	3	WASHER,LOCK, CD PL STL, 0.391 ID X 0.507 OD (V78189) 373-0081-000 (AP FOR 59-63)	CC	4
	205	3	WASHER,SHLDR, GRA FBR, 0.250 ID X 0.500 OD (V37942) 302-1800-000 (AP FOR 59-63)	CC	1
	310-0061-000	3	WASHER,FLAT, BRS, 0.265 ID X 0.625 OD (V79807) 310-0061-000 (AP FOR 59-63)	CC	1
64	TF300	3	TERMINAL,STUD, (V98291) 306-1018-000		3
	MS51957-2	3	SCREW,MACH, SST, 2-56 X 3/16 (V96906) 343-0123-000 (AP)		3
	MS35338-134	3	WASHER,LOCK, SST, 0.088 ID X 0.172 OD (V96906) 310-0275-000 (AP)		3
65	403	3	TERMINAL,LUG, (V79963) 304-1089-000		1
	P313-0132-000	3	NUT,PLAIN,HEX, SST, 4-40 (V77250) 313-0132-000 (AP)		1
	MS51957-13	3	SCREW,MACH, STL, 4-40 X 1/4 (V96906) 343-0133-000 (AP)		1
66	4007-4HT	3	TERMINAL,LUG, (V77147) 304-0015-000		1
	MS51957-2	3	SCREW,MACH, SST, 2-56 X 3/16 (V96906) 343-0123-000 (AP)		1

## GROUP ASSEMBLY PARTS LIST

FIG - ITEM	PART NO	INDENT	DESCRIPTION	USABLE ON CODE	UNITS PER ASSY
39	MS35338-134	3	WASHER, LOCK, SST, 0.088 ID X 0.172 OD (V96906)		1
	TF300	3	310-0275-000 (AP)		1
67	606-9428-001	3	3 TERMINAL, STD, (V98291) 306-1018-000 (AP)		1
68	RCR20G101KS	3	BRACKET, RESISTOR		1
		2	RESISTOR, FXD, CMPSN, 100 OHMS, 10%, 1/2W		1
			(V81349) 745-1310-000 R174		
69	RCR20G101KS	2	RESISTOR, FXD, CMPSN, 100 OHMS, 10%, 1/2W		1
			(V81349) 745-1310-000 R183		
70	11J1043	2	JACK, TEL, (V82389) 360-0433-010 J58		1
	P334-4121-00	2	NUT, PLAIN, HEX, SST, 3/8-32UNF-2B (V77250)		1
			334-4121-000 (AP)		
71	540-9003-003	2	POST, MOUNTING		2
	P342-0142-000	2	SCREW, MACH, NP RRS, 2-56 X 3/16 (V77250)		2
			342-0142-000 (AP)		
72	606-9414-001	2	POST		2
	MS51959-12	2	SCREW, MACH, SST, 4-40 X 3/16 (V96906)		2
			342-0043-000 (AP)		
73	606-9707-002	2	HOUSING, INDICATOR		1
	MS51959-14	2	SCREW, MACH, SST, 4-40 X 5/16 (V96906)		6
			342-0045-000 (AP)		
74	606-9447-001	3	LIGHT, CONDUCTOR-DECIMAL		1
75	CM39-04-5	3	FILTER, LAMP, (V71744) 262-1296-190		2
76	62	3	LAMP, INCAND, (V17537) 262-2732-000 DS104		1
77	606-9448-001	3	LIGHT, CONDUCTOR-COMMA		1
78	62	3	LAMP, INCAND, (V17537) 262-2732-000 DS105		1
79	606-9719-001	3	RETAINER, PRESSED		2
	MS35649-224	3	NUT, PLAIN, HEX, SST, 2-56 (V96906) 313-0037-000		4
			(AP)		
	P347-1269-000	3	SCREW, MACH, SST, 2-56 X 5/16 (V77250)		4
			347-1269-000 (AP)		
80	G2619	4	TERMINAL, STD, (V21242) 306-0324-000		4
81	606-9410-001	4	RETAINER		1
82	RCR05G153JS	3	RESISTOR, FXD, CMPSN, 15K, 5%, 1/8W (V81349)		1
			745-1863-770 R131		
83	RCR05G153JS	3	RESISTOR, FXD, CMPSN, 15K, 5%, 1/8W (V81349)		1
			745-1863-770 R125		
84	RCR05G153JS	3	RESISTOR, FXD, CMPSN, 15K, 5%, 1/8W (V81349)		1
			745-1863-770 R126		
85	RCR05G153JS	3	RESISTOR, FXD, CMPSN, 15K, 5%, 1/8W (V81349)		1
			745-1863-770 R127		
86	RCR05G153JS	3	RESISTOR, FXD, CMPSN, 15K, 5%, 1/8W (V81349)		1
			745-1863-770 R139		
87	RCR05G153JS	3	RESISTOR, FXD, CMPSN, 15K, 5%, 1/8W (V81349)		1
			745-1863-770 R133		
88	RCR05G153JS	3	RESISTOR, FXD, CMPSN, 15K, 5%, 1/8W (V81349)		1
			745-1863-770 R134		
89	RCR05G153JS	3	RESISTOR, FXD, CMPSN, 15K, 5%, 1/8W (V81349)		1
			745-1863-770 R135		
90	RCR05G153JS	3	RESISTOR, FXD, CMPSN, 15K, 5%, 1/8W (V81349)		1
			745-1863-770 R147		
91	RCR05G153JS	3	RESISTOR, FXD, CMPSN, 15K, 5%, 1/8W (V81349)		1
			745-1863-770 R141		
92	RCR05G153JS	3	RESISTOR, FXD, CMPSN, 15K, 5%, 1/8W (V81349)		1
			745-1863-770 R142		
93	RCR05G153JS	3	RESISTOR, FXD, CMPSN, 15K, 5%, 1/8W (V81349)		1
			745-1863-770 R143		
94	RCR05G153JS	3	RESISTOR, FXD, CMPSN, 15K, 5%, 1/8W (V81349)		1
			745-1863-770 R155		
95	RCR05G153JS	3	RESISTOR, FXD, CMPSN, 15K, 5%, 1/8W (V81349)		1
			745-1863-770 R149		
96	RCR05G153JS	3	RESISTOR, FXD, CMPSN, 15K, 5%, 1/8W (V81349)		1
			745-1863-770 R150		

GROUP ASSEMBLY PARTS LIST

FIG - ITEM	PART NO	INDENT	DESCRIPTION	USABLE ON CODE	UNITS PER ASSY
39 97	RCR05G153JS	3	RESISTOR,FXD, CMPSN, 15K, 5%, 1/8W (V81349) 745-1863-770 R151		1
98	RCR05G153JS	3	RESISTOR,FXD, CMPSN, 15K, 5%, 1/8W (V81349) 745-1863-770 R163		1
99	RCR05G153JS	3	RESISTOR,FXD, CMPSN, 15K, 5%, 1/8W (V81349) 745-1863-770 R157		1
100	RCR05G153JS	3	RESISTOR,FXD, CMPSN, 15K, 5%, 1/8W (V81349) 745-1863-770 R158		1
101	RCR05G153JS	3	RESISTOR,FXD, CMPSN, 15K, 5%, 1/8W (V81349) 745-1863-770 R159		1
102	RCR05G153JS	3	RESISTOR,FXD, CMPSN, 15K, 5%, 1/8W (V81349) 745-1863-770 R171		1
103	RCR05G153JS	3	RESISTOR,FXD, CMPSN, 15K, 5%, 1/8W (V81349) 745-1863-770 R165		1
104	RCR05G153JS	3	RESISTOR,FXD, CMPSN, 15K, 5%, 1/8W (V81349) 745-1863-770 R166		1
105	RCR05G153JS	3	RESISTOR,FXD, CMPSN, 15K, 5%, 1/8W (V81349) 745-1863-770 R167		1
106	RCR05G153JS	3	RESISTOR,FXD, CMPSN, 15K, 5%, 1/8W (V81349) 745-1863-770 R168		1
107	RCR05G153JS	3	RESISTOR,FXD, CMPSN, 15K, 5%, 1/8W (V81349) 745-1863-770 R169		1
108	RCR20G820KS	3	RESISTOR,FXD, CMPSN, 82 OHMS, 10%, 1/2W (V81349) 745-1307-000 R172		1
109	RCR05G153JS	3	RESISTOR,FXD, CMPSN, 15K, 5%, 1/8W (V81349) 745-1863-770 R170		1
110	RCR05G153JS	3	RESISTOR,FXD, CMPSN, 15K, 5%, 1/8W (V81349) 745-1863-770 R160		1
111	RCR05G153JS	3	RESISTOR,FXD, CMPSN, 15K, 5%, 1/8W (V81349) 745-1863-770 R161		1
112	RCR20G820KS	3	RESISTOR,FXD, CMPSN, 82 OHMS, 10%, 1/2W (V81349) 745-1307-000 R164		1
113	RCR05G153JS	3	RESISTOR,FXD, CMPSN, 15K, 5%, 1/8W (V81349) 745-1863-770 R162		1
114	RCR05G153JS	3	RESISTOR,FXD, CMPSN, 15K, 5%, 1/8W (V81349) 745-1863-770 R152		1
115	RCR05G153JS	3	RESISTOR,FXD, CMPSN, 15K, 5%, 1/8W (V81349) 745-1863-770 R153		1
116	RCR20G820KS	3	RESISTOR,FXD, CMPSN, 82 OHMS, 10%, 1/2W (V81349) 745-1307-000 R156		1
117	RCR05G153JS	3	RESISTOR,FXD, CMPSN, 15K, 5%, 1/8W (V81349) 745-1863-770 R154		1
118	RCR05G153JS	3	RESISTOR,FXD, CMPSN, 15K, 5%, 1/8W (V81349) 745-1863-770 R144		1
119	RCR05G153JS	3	RESISTOR,FXD, CMPSN, 15K, 5%, 1/8W (V81349) 745-1863-770 R145		1
120	RCR20G820KS	3	RESISTOR,FXD, CMPSN, 82 OHMS, 10%, 1/2W (V81349) 745-1307-000 R148		1
121	RCR05G153JS	3	RESISTOR,FXD, CMPSN, 15K, 5%, 1/8W (V81349) 745-1863-770 R146		1
122	RCR05G153JS	3	RESISTOR,FXD, CMPSN, 15K, 5%, 1/8W (V81349) 745-1863-770 R136		1
123	RCR05G153JS	3	RESISTOR,FXD, CMPSN, 15K, 5%, 1/8W (V81349) 745-1863-770 R137		1
124	RCR20G820KS	3	RESISTOR,FXD, CMPSN, 82 OHMS, 10%, 1/2W (V81349) 745-1307-000 R140		1
125	RCR05G153JS	3	RESISTOR,FXD, CMPSN, 15K, 5%, 1/8W (V81349) 745-1863-770 R138		1
126	RCR05G153JS	3	RESISTOR,FXD, CMPSN, 15K, 5%, 1/8W (V81349) 745-1863-770 R128		1
127	RCR20G820KS	3	RESISTOR,FXD, CMPSN, 82 OHMS, 10%, 1/2W (V81349) 745-1307-000 R132		1

## GROUP ASSEMBLY PARTS LIST

FIG - ITEM	PART NO	INDENT	DESCRIPTION	USABLE ON CODE	UNITS PER ASSY
39 128	RCR05G153JS	3	RESISTOR,FXD, CMPSN, 15K, 5%, 1/8W (V81349) 745-1863-770 R129		1
129	RCR05G153JS	3	RESISTOR,FXD, CMPSN, 15K, 5%, 1/8W (V81349) 745-1863-770 R130		1
130	609-0931-001	3	CLAMP, DOUBLE-SOCKET		7
131	220-1283-020	3	BASE, (V95354) 220-1283-020		6
	P313-0132-000	3	NUT,PLAIN,HEX, SST, 4-40 (V77250) 313-0132-000 (AP FOR 130,131)		7
	MS51957-14	3	SCREW,MACH, STL, 4-40 X 5/16 (V96906) 343-0134-000 (AP FOR 130,131)		7
132	606-9721-001	3	HOUSING, PRESSED		1
133	G2619	4	TERMINAL,STHD, (V21242) 306-0324-000		16
134	R22NCFMA1-40	4	NUT,SLFLKG, CD PL STL, 4-40 (V72962) 333-0839-000		5
135	606-9401-001	4	HOUSING		1
136	606-9412-002	2	STRIP, NUT		2
	P313-0132-000	2	NUT,PLAIN,HEX, SST, 4-40 (V77250) 313-0132-000 (AP)		2
	MS35338-135	2	WASHER,LOCK, SST, 0.115 ID X 0.209 OD (V96906) 310-0279-000 (AP)		2
	2104-04-01-2520N	2	TERMINAL,LUG, (V78189) 304-0317-000 (AP)		1
	4040-5HDSPL	2	TERMINAL,LUG, (V77147) 304-0332-000 (AP)		1
	P330-2292-000	2	SCREW,MACH, SST, 4-40 X 3/8 (V77250) 330-2292-000 (AP)		2
	MS51959-12	2	SCREW,MACH, SST, 4-40 X 3/16 (V96906) 342-0043-000 (AP)		2
137	609-0505-001	2	LEG		2
138	609-0566-001	2	CLIP		2
	MS51957-28	2	SCREW,MACH, SST, 6-32 X 3/8 (V96906) 343-0169-000 (AP FOR 137,138)		2
	MS35338-136	2	WASHER,LOCK, SST, 0.141 ID X 0.250 OD (V96906) 310-0282-000 (AP FOR 137,138)		2
139	606-9395-001	2	PLATE, FILLER		1
	MS51957-13	2	SCREW,MACH, STL, 4-40 X 1/4 (V96906) 343-0133-000 (AP)		3
	MS35338-135	2	WASHER,LOCK, SST, 0.115 ID X 0.209 OD (V96906) 310-0279-000 (AP)		3
140	606-9416-001	2	BEARING, SHAFT		1
	MS51959-14	2	SCREW,MACH, SST, 4-40 X 5/16 (V96906) 342-0045-000 (AP)		1
	68-1660-40	2	NUT,SLFLKG,HEX, AL, 4-40 (V72962) 333-0605-000 (AP)		1
141	606-9446-002	2	PANEL, FRONT		1
40 -	606-9424-002	1	POWER SUPPLY, RADIO RECEIVER (SEE FIG 26-14 FOR NHA)	CE	RF
-	606-9424-004	1	POWER SUPPLY, RADIO RECEIVER (SEE FIG 26-14 FOR NHA)	CF	RF
-	606-9424-005	1	POWER SUPPLY, RADIO RECEIVER (SEE FIG 26-14 FOR NHA)	CG	RF
-	606-9424-006	1	POWER SUPPLY, RADIO RECEIVER (SEE FIG 26-14 FOR NHA)	CH	RF
1	609-0494-003	2	GASKET, STRIP		1
2	20049	2	GUARN, (V82877) 009-0178-020		1
	68NM62	2	NUT,SLFLKG,HEX, AL, 6-32 (V72962) 333-0368-000 (AP)		4

GROUP ASSEMBLY PARTS LIST

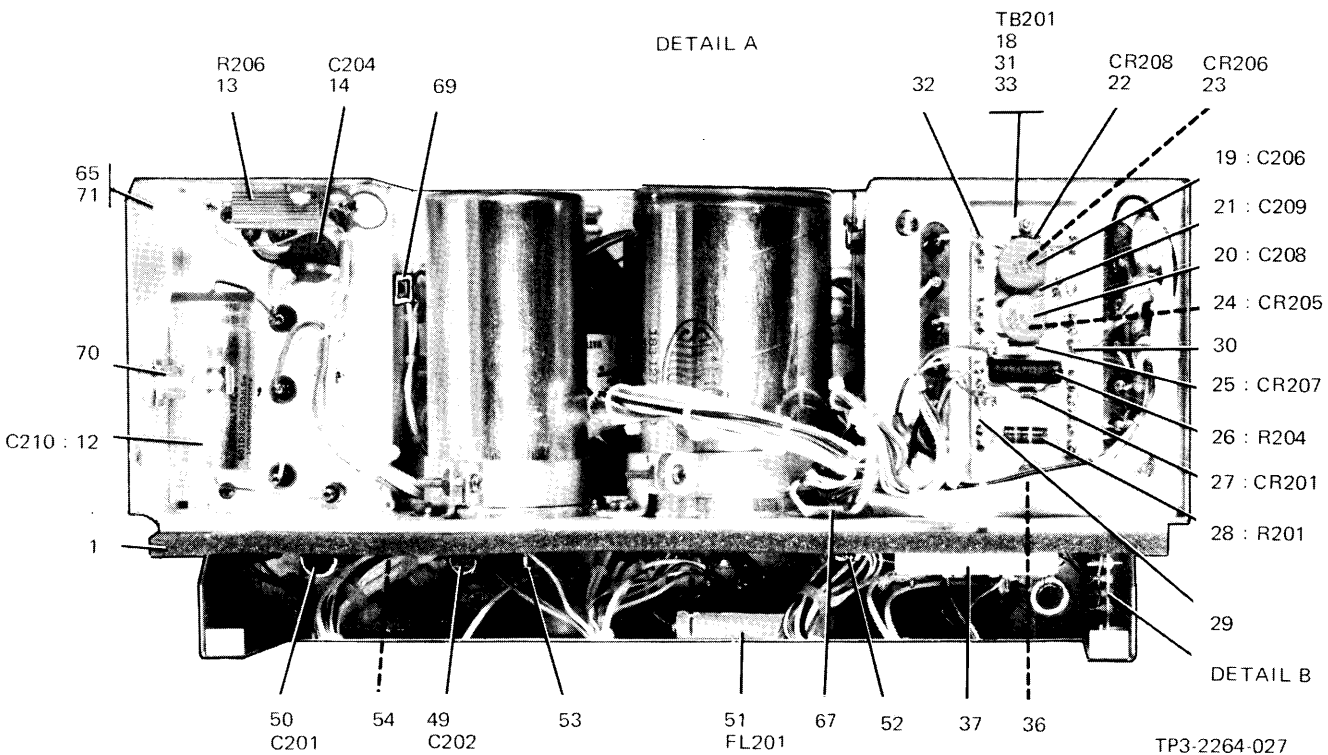
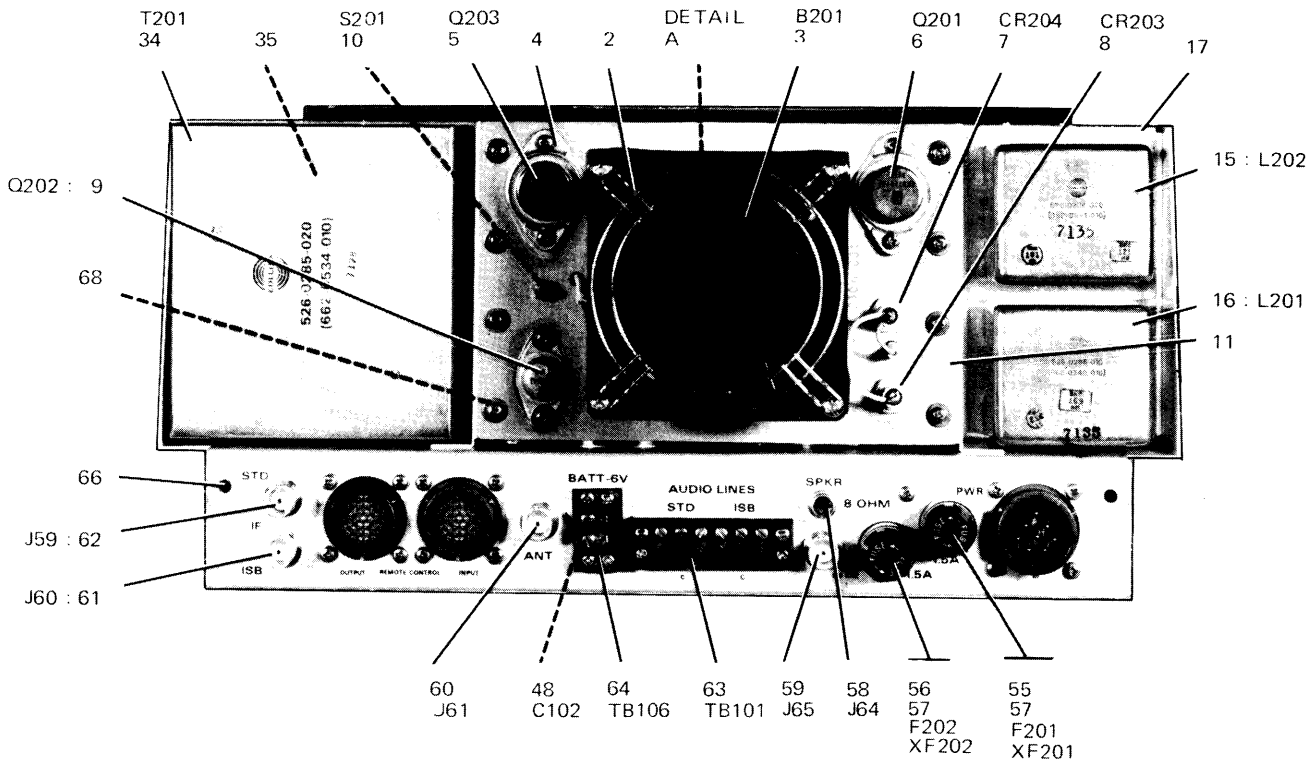

Radio Receiver Power Supply 606-9424-002, -004, -005, -006  
Figure 40 (Sheet 1 of 2)

GROUP ASSEMBLY PARTS LIST

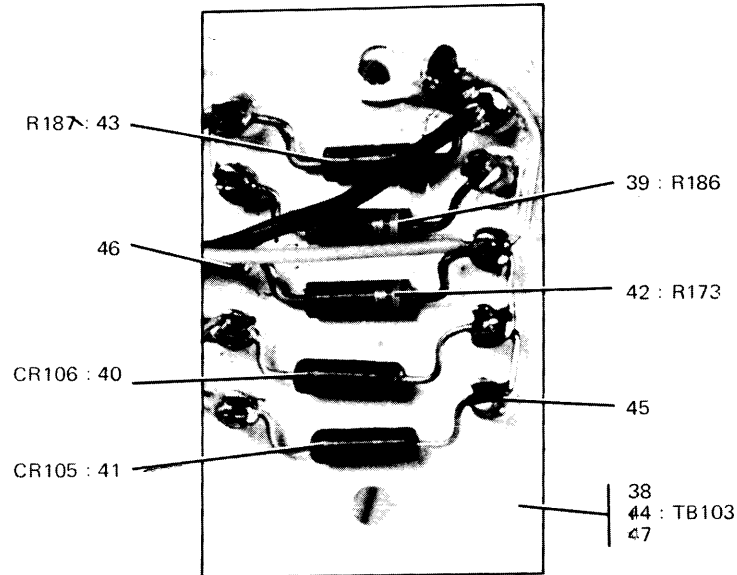

DETAIL B

TP3-2264-027

Radio Receiver Power Supply 606-9424-002, -004, -005, -006  
Figure 40 (Sheet 2 of 2)

FIG - ITEM	PART NO	INDENT	DESCRIPTION	USABLE ON CODE	UNITS PER ASSY
40	P343-0331-000	2	SCREW, MACH, NP BRS, 6-32 X 7/16 (V77250) 343-0331-000 (AP)		4
3	A074675	2	FAN, TUBE AXIAL, (V82877) 009-0178-040 B201		1
4	609-0496-001	2	GASKET		1
	P313-0053-000	2	NUT, PLAIN, HEX, NP BRS, 6-32 (V77250) 313-0053-000 (AP FOR 3,4)		4
	P343-0332-000	2	SCREW, MACH, NP BRS, 6-32 X 1/2 (V77250) 343-0332-000 (AP FOR 3,4)		4
5	2N3716	2	TRANSISTOR, (V07688) 352-0677-040 Q203		1
6	2N3716	2	TRANSISTOR, (V07688) 352-0677-040 Q201		1
	M935649-244	2	NUT, PLAIN, HEX, SST, 4-40 (V96906) 313-0043-000 (AP FOR 5,6)		4
	M935338-135	2	WASHER, LOCK, SST, 0.115 ID X 0.209 OD (V06906) 310-0279-000 (AP FOR 5,6)		4
	2504-04-00-2220N	2	TERMINAL, LUG, (V78189) 304-0271-000 (AP FOR 5,6)		2
	310-0054-000	2	WASHER, FLAT, BRS, 0.125 ID X 0.312 OD (V79807) 310-0054-000 (AP FOR 5,6)		4
	302-0646-050	2	WASHER, NM, SHLDR, PLSTC, 0.115 ID X 0.290 OD (V07896) 302-0646-050 (AP FOR 5,6)		4
	43-03-2	2	INSULATOR, PL, (V13103) 352-9605-020 (AP FOR 5,6)		2
	M951957-17	2	SCREW, MACH, STL, 4-40 X 1/2 (V96906) 343-0137-000 (AP FOR 5,6)		4
7	1N1200R	2	SEMICONV DEVICE, (V07688) 353-6213-000 CR204		1

GROUP ASSEMBLY PARTS LIST

FIG - ITEM	PART NO	INDENT	DESCRIPTION	USABLE ON CODE	UNITS PER ASSY	
40	8	1N1200R	2 SEMICONV DEVICE, (V07688) 353-6213-000 CR203		1	
			MH745	2 MOUNTING KIT, (V04713) 352-9971-000 (AP FOR 7,8)		2
		2115	2 TERMINAL LUG, (V91886) 304-1466-010 (AP FOR 7,8)		2	
		P313-0056-000	2 NUT, PLAIN, HEX, NP BRS, 10-32 (V77250)		2	
			313-0056-000 (AP FOR 7,8)		2	
9	2N3741	MS35649-244	2 TRANSISTOR, (V07688) 352-0695-020 Q202		1	
			2 NUT, PLAIN, HEX, SST, 4-40 (V96906) 313-0043-000 (AP)		2	
			MS35338-135	2 WASHER, LOCK, SST, 0.115 ID X 0.209 OD (V96906)		2
				310-0279-000 (AP)		
			2504-04-00-2220N	2 TERMINAL LUG, (V78189) 304-0271-000 (AP)		1
			310-0054-000	2 WASHER, FLAT, BRS, 0.125 ID X 0.312 OD (V79807)		2
				310-0054-000 (AP)		
			302-0646-050	2 WASHER, NM, SHLDR, PLSTC, 0.115 ID X 0.290 OD (V07496) 302-0646-050 (AP)		2
			43-66-1	2 INSULATOR, PL, (V13103) 352-9605-190 (AP)		1
			MS51957-17	2 SCREW, MACH, STL, 4-40 X 1/2 (V96906)		2
		343-0137-000 (AP)				
10	C4344-207-4	P313-0140-000	2 SWITCH, THRMSTC, (V82647) 267-0243-020 S201		1	
			2 NUT, PLAIN, HEX, NP BRS, 6-32 (V77250)		1	
			313-0140-000 (AP)			
		310-0078-000	2 WASHER, LOCK, BRZ, 0.141 ID X 0.239 OD (V79807)		1	
			310-0078-000 (AP)			
11	609-0306-001	MS51957-15	2 HEATSINK		1	
			2 SCREW, MACH, STL, 4-40 X 3/8 (V96906)		8	
			343-0135-000 (AP)			
		310-0045-000	2 WASHER, FLAT, SST, 0.125 ID X 0.312 OD (V79807)		8	
			310-0045-000 (AP)			
12	601D108G050JL6		2 CAPACITOR, FXD, ELCTLT, 1000UF, M10XP75%, 50V (V56289) 183-1282-140 C210		1	
			2 RESISTOR, FXD, HW, 1K, 1%, 20W (V81349)		1	
13	RE70G1001	68NM40	747-8835-000 R206		1	
			2 NUT, SLFLKG, HEX, AL, 4-40 (V72962) 333-0347-000 (AP)		2	
			2 SCREW, MACH, NP BRS, 4-40 X 5/16 (V77250)		2	
		P343-0286-000	343-0286-000 (AP)			
14	36C175A		2 CAPACITOR, FXD, CER DIEI, 10000PF, 20%, 500V (V56289) 913-3013-000 C204		1	
			2 REACTOR, 668-0241-010 L202		1	
15	668-0241-010		2 REACTOR, 668-0240-010 L201		1	
16	668-0240-010				1	
17	606-9437-001	MS51957-14	2 PLATE, SHIELD		1	
			2 SCREW, MACH, STL, 4-40 X 5/16 (V96906)		7	
			343-0134-000 (AP FOR 15-17)			
	4720-54-1		2 TERMINAL, STIID, (V17117) 306-1087-000 (AP FOR 16)		1	
18	609-0550-001	MS35649-224	2 COMPONENT ASSY, ELECTRONIC		1	
			2 NUT, PLAIN, HEX, SST, 2-56 (V96906) 313-0037-000 (AP)		2	
			2 WASHER, LOCK, SST, 0.088 ID X 0.172 OD (V96906)		2	
		MS35338-134	310-0275-000 (AP)			
19	36C175A		3 CAPACITOR, FXD, CER DIEI, 10000PF, 20%, 500V (V56289) 913-3013-000 C206		1	
20	36C175A		3 CAPACITOR, FXD, CER DIEI, 10000PF, 20%, 500V (V56289) 913-3013-000 C208		1	
21	36C175A		3 CAPACITOR, FXD, CER DIEI, 10000PF, 20%, 500V (V56289) 913-3013-000 C209		1	
22	1N5198		3 SEMICONV DEVICE, (V07688) 353-6495-020 CR208 (EFF TO CI 72304)		1	
22	1N5550		3 SEMICONV DEVICE, (V14099) 353-3718-040 CR208 (EFF CI 72304)		1	
23	1N4003		3 SEMICONV DEVICE, (V04713) 353-6442-030 CR206		1	
24	1N4003		3 SEMICONV DEVICE, (V04713) 353-6442-030 CR205		1	
25	1N5198		3 SEMICONV DEVICE, (V07688) 353-6495-020 CR207 (EFF TO CI 72304)		1	
25	1N5550		3 SEMICONV DEVICE, (V14099) 353-3718-040 CR207 (EFF CI 72304)		1	



## GROUP ASSEMBLY PARTS LIST

FIG - ITEM	PART NO	INDENT	DESCRIPTION	USABLE ON CODE	UNITS PER ASSY
40 26	Rw67V120	3	RESISTOR,FXD,HW, 12 OHMS, 5%, 6.5W (V81349) 747-5422-000 R204		1
27	1N4003	3	SEMICOND DEVICE, (V04713) 353-6442-030 CR201		1
28	RCR32G180KS	3	RESISTOR,FXD, CMPSN, 18 OHMS, 10%, 1W (V81349) 745-7279-000 R201		1
29	4040-2HDSPL MS35338-96	3	TERMINAL,LUG, (V77147) 304-0331-000		3
		3	WASHER,LOCK, BRZ, 0.088 ID X 0.175 OD (V96906) 310-0074-000 (AP)		2
	MS51957-3	3	SCREW,MACH, CD PL STL, 2-56 X 1/4 (V96906) 343-0124-000 (AP)		2
30	TF300	3	TERMINAL,STUD, (V98291) 306-1018-000		2
	MS51957-2	3	SCREW,MACH, SST, 2-56 X 3/16 (V96906) 343-0123-000 (AP)		2
	MS35338-96	3	WASHER,LOCK, BRZ, 0.088 ID X 0.175 OD (V96906) 310-0074-000 (AP)		2
31	606-9723-001	3	TERMINAL BOARD, PRESSED TB201		1
32	SL441-434WHT	4	TERMINAL,STUD, (V12615) 306-2222-100		21
33	606-9701-001	4	TERMINAL BOARD		1
34	662-0534-010	2	TRANSFORMER,PWR, 662-0534-010 T201		1
35	606-9444-001	2	SHIELD		1
	P343-0330-000	2	SCREW,MACH, NP BRZ, 6-32 X 3/8 (V77250) 343-0330-000 (AP FOR 34,35)		4
	310-0055-000	2	WASHER,FLAT, BRZ, 0.147 ID X 0.312 OD (V79807) 310-0055-000 (AP FOR 34,35)		4
36	540-9002-003	2	POST		2
	P342-0147-000	2	SCREW,MACH, NI PL BRZ, 2-56 X 1/2 (V77250) 342-0147-000 (AP)		2
	MS35338-134	2	WASHER,LOCK, SST, 0.088 ID X 0.172 OD (V96906) 310-0275-000 (AP)		2
37	606-9884-001	2	BLANKER, IF, (EFF TO CI 72285)(SEE FIG 28)	CE	1
	68-1660-40	2	NUT,SLFLKG,HEX, AL, 4-40 (V72962) 333-0605-000 (AP) (EFF TO CI 72285)	CE	2
38	609-0549-001	2	COMPONENT ASSY, ELECTRONIC	CE,CG	1
38	609-0549-002	2	COMPONENT ASSY, ELECTRONIC	CF,CH	1
	MS35649-224	2	NUT,PLAIN,HEX, SST, 2-56 (V96906) 313-0037-000 (AP)		2
	MS35338-134	2	WASHER,LOCK, SST, 0.088 ID X 0.172 OD (V96906) 310-0275-000 (AP)		2
	4040-2HDSPL	2	TERMINAL,LUG, (V77147) 304-0331-000 (AP)		1
	541-5953-002	2	SPACER, (AP)		2
	MS51959-7	2	SCREW,MACH, SST, 2-56 X 1/2 (V96906) 342-0137-000 (AP)		2
39	RCR07G472KS	3	RESISTOR,FXD, CMPSN, 4.7K, 10%, 1/4W (V81349) 745-0773-000 R186		1
40	1N459	3	SEMICOND DEVICE, (V07688) 353-0206-000 CR106	CE,CG	1
41	1N459	3	SEMICOND DEVICE, (V07688) 353-0206-000 CR105	CE,CG	1
42	RCR07G222KS	3	RESISTOR,FXD, CMPSN, 2.2K, 10%, 1/4W (V81349) 745-0761-000 R173		1
43	RCR07G103KS	3	RESISTOR,FXD, CMPSN, 10K, 10%, 1/4W (V81349) 745-0785-000 R187		1
44	606-9724-001	3	TERMINAL BOARD, PRESSED TB103		1
45	SL441-434WHT	4	TERMINAL,STUD, (V12615) 306-2222-100		7
46	MS-540-3	4	TERMINAL,FEEDTH, (V12615) 306-2608-050		1
47	606-9441-001	4	TERMINAL BOARD		1
48	M39003-01-2111	2	CAPACITOR,FXD, ELCTLT, 0.47UF, 20%, 50V (V81349) CE,CF 184-0084-380 C102		1
49	41C157	2	CAPACITOR,FXD, CER DIEI, 0.010UF, 20%, 125V (V56289) 913-6921-030 C202		1
50	41C157	2	CAPACITOR,FXD, CER DIEI, 0.010UF, 20%, 125V (V56289) 913-6921-030 C201		1
51	A188	2	FILTER,LP, (V81815) 241-0609-010 FL201		1
	P313-0156-00	2	NUT,PLAIN,HEX, NP BRZ, 4-40 (V77250) 313-0156-000 (AP)		2
	310-0278-000	2	WASHER,LOCK, SST, 0.115 ID X 0.202 OD (V70318) 310-0278-000 (AP)		2

GROUP ASSEMBLY PARTS LIST

FIG - ITEM	PART NO	INDENT	DESCRIPTION	USABLE ON CODE	UNITS PER ASSY
40	4040-5HDSPL	2	TERMINAL,LUG, (V77147) 304-0332-000 (AP)		1
	P342-0152-000	2	SCREW,MACH, NP BRS, 4-40 X 1/4 (V77250)		2
			342-0152-000 (AP)		
52	547-5305-002	2	LUG, GROUND		2
	P313-0053-000	2	NUT,PLAIN,HEX, NP BRS, 6-32 (V77250)		1
			313-0053-000 (AP)		
	310-0078-000	2	WASHER,LOCK, BRZ, 0.141 ID X 0.239 OD (V79807)		1
			310-0078-000 (AP)		
	P343-0330-000	2	SCREW,MACH, NP BRS, 6-32 X 3/8 (V77250)		1
			343-0330-000 (AP)		
53	547-5305-002	2	LUG, GROUND		1
	MS35649-244	2	NUT,PLAIN,HEX, SST, 4-40 (V96906)		1
			313-0043-000 (AP)		
	MS3533A-135	2	WASHER,LOCK, SST, 0.115 ID X 0.209 OD (V96906)		1
			310-0279-000 (AP)		
	2104-04-01-2520N	2	TERMINAL,LUG, (V78189) 304-0317-000 (AP)		1
	MS51957-14	2	SCREW,MACH, STL, 4-40 X 5/16 (V96906)		1
			343-0134-000 (AP)		
54	MS21266-1N	2	PLASTIC CHANNEL, (V96906) 150-0173-000		AR
55	MDL1 1-2	2	FUSE,CRTG, (V71400) 264-0296-000 F201		1
56	MDL1 1-2	2	FUSE,CRTG, (V71400) 264-0296-000 F202		1
57	HTA	2	FUSEHOLDER, (V71400) 265-0005-010 XF201,XF202		2
58	3501FP	2	PHONE-JACK, (V82389) 360-0148-000 J64		1
	AN936A416B	2	WASHER,LOCK, CD PL BRZ, 0.267 ID X 0.478 OD (V88044) 373-3050-000 (AP)		1
59	M39012-21-0001	2	CONNECTOR,RCPT, ELEC (V81349) 357-9670-000 J65		1
60	M39012-21-0001	2	CONNECTOR,RCPT, ELEC (V81349) 357-9670-000 J61		1
61	M39012-21-0001	2	CONNECTOR,RCPT, ELEC (V81349) 357-9670-000 J60		1
62	M39012-21-0001	2	CONNECTOR,RCPT, ELEC (V81349) 357-9670-000 J59		1
	31-759	2	TERMINAL,LUG, (V02660) 304-0139-000 (AP FOR 59-62)		4
63	410MY6	2	TERMINAL BOARD, (V75382) 367-1860-060 TB101		1
64	410MY2	2	TERMINAL BOARD, (V75382) 367-1860-020 TB106	CE,CF	1
	P313-0156-00	2	NUT,PLAIN,HEX, NP BRS, 4-40 (V77250)	CE,CF	8
			313-0156-000 (AP FOR 63,64)		
	P313-0156-00	2	NUT,PLAIN,HEX, NP BRS, 4-40 (V77250)	CG,CH	4
			313-0156-000 (AP FOR 63)		
	P347-0009-000	2	SCREW,MACH, SST, 4-40 X 7/16 (V77250)	CE,CF	8
			347-0009-000 (AP FOR 63,64)		
	P347-0009-000	2	SCREW,MACH, SST, 4-40 X 7/16 (V77250)	CG,CH	4
			347-0009-000 (AP FOR 63)		
65	606-9870-002	2	CHASSIS, POWER SUPPLY		1
66	NAS1068A06	3	NUT,SLFLKG,PL, CD PL STL, 6-32 (V72962)		2
			333-0888-000		
	MS20426AD2-3	3	RIVET,SOLID, AL, 1/16 DIA X 3/16 (V96906)		4
			305-1352-000 (AP)		
67	FHS440-4	3	STUD,CAPTIVE, SST, 4-40 X 1/4 (V46384)		2
			330-2792-000		
68	R22NCFMA1-40	3	NUT,SLFLKG, CD PL STL, 4-40 (V72962)		8
			333-0839-000		
69	10BRZ	3	CLIP,ELEC, 362-0029-090		1
70	E50008-051	3	RETAINER,CAP, (V80033) 139-0090-000		1
	MS16535-152	3	RIVET,TUBULAR, AL, 0.123 DIA X 0.125 (V96906)		2
			305-1807-000 (AP FOR 69,70)		
71	609-0541-001	3	CHASSIS		1

GROUP ASSEMBLY PARTS LIST

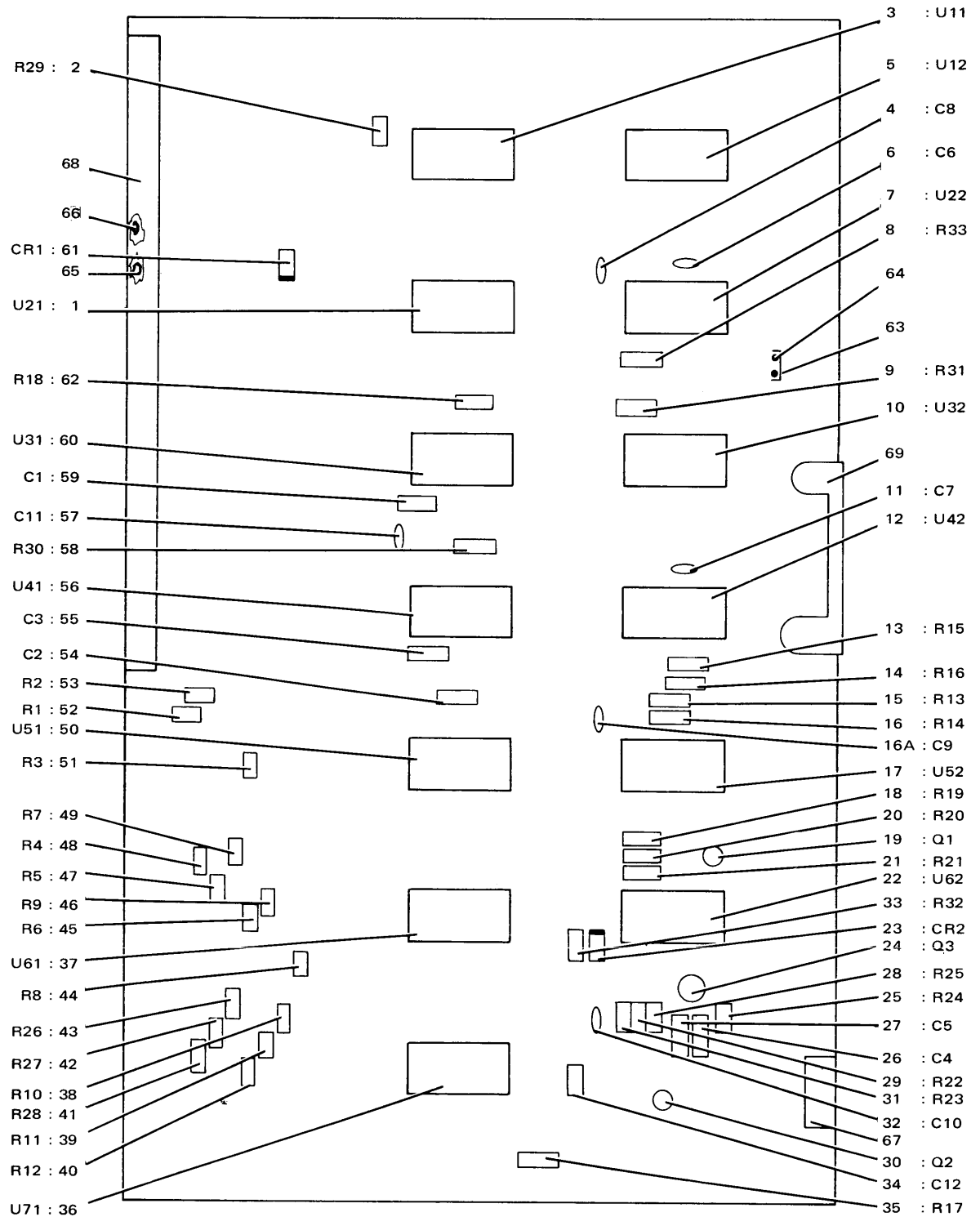

TP3-2233-019

Auto Scan Control Circuit Card Assembly 783-9368-001  
Figure 41

GROUP ASSEMBLY PARTS LIST

FIG - ITEM	PART NO	INDENT	DESCRIPTION	USABLE ON CODE	UNITS PER ASSY
41	783-9368-001	1	CIRCUIT CARD ASSY, AUTO SCAN CONTROL A9 (SEE FIG 1-42 FOR NHA)	A,C,D,G H,J,K,L N,Y,AA AC,AE,AG AM,AN,AP AR,AT,AU	RF
1	S8880A	2	INTEGRATED CKT, (V18324) 351-7465-030 A9U21		1
2	RCR07G472KS	2	RESISTOR,FXD, CMPSN, 4.7K, 10%, 1/4W (V81349) 745-0773-000 A9R29		1
3	S8281A	2	INTEGRATED CKT, (V18324) 351-7510-020 A9U11		1
4	8121-050-651-104 Z	2	CAPACITOR,FXD, CER DIEI, 0.1UF, M20XP80X, 50V (V72982) 913-3279-500 A9C8		1
5	S8816A	2	INTEGRATED CKT, (V18324) 351-7465-010 A9U12		1
6	8101-050-651-152 M	2	CAPACITOR,FXD, CER DIEI, 1500PF, 20X, 50V (V72982) 913-3279-040 A9C6		1
7	SG8303	2	INTEGRATED CKT, (V93332) 351-7310-040 A9U22		1
8	RCR07G472KS	2	RESISTOR,FXD, CMPSN, 4.7K, 10%, 1/4W (V81349) 745-0773-000 A9R33		1
9	RCR07G101KS	2	RESISTOR,FXD, CMPSN, 100 OHMS, 10%, 1/4W (V81349) 745-0713-000 A9R31		1
10	S8880A	2	INTEGRATED CKT, (V18324) 351-7465-030 A9U32		1
11	8111-050-651-222 M	2	CAPACITOR,FXD, CER DIEI, 2200PF, 20X, 50V (V72982) 913-3279-060 A9C7		1
12	SG8303	2	INTEGRATED CKT, (V93332) 351-7310-040 A9U42		1
13	RCR07G103KS	2	RESISTOR,FXD, CMPSN, 10K, 10%, 1/4W (V81349) 745-0785-000 A9R15		1
14	RCR07G103KS	2	RESISTOR,FXD, CMPSN, 10K, 10%, 1/4W (V81349) 745-0785-000 A9R16		1
15	RCR07G103KS	2	RESISTOR,FXD, CMPSN, 10K, 10%, 1/4W (V81349) 745-0785-000 A9R13		1
16	RCR07G103KS	2	RESISTOR,FXD, CMPSN, 10K, 10%, 1/4W (V81349) 745-0785-000 A9R14		1
16A	8121-050-651-104 Z	2	CAPACITOR,FXD, CER DIEI, 0.1UF, M20XP80X, 50V (V72982) 913-3279-500 A9C9		1
17	S8822A	2	INTEGRATED CKT, (V18324) 351-7465-090 A9U52		1
18	RCR07G472KS	2	RESISTOR,FXD, CMPSN, 4.7K, 10%, 1/4W (V81349) 745-0773-000 A9R19		1
19	2N2222A	2	TRANSISTOR, (V81350) 352-7500-280 A9Q1		1
20	RCR07G473KS	2	RESISTOR,FXD, CMPSN, 47K, 10%, 1/4W (V81349) 745-0809-000 A9R20		1
21	RCR07G472KS	2	RESISTOR,FXD, CMPSN, 4.7K, 10%, 1/4W (V81349) 745-0773-000 A9R21		1
22	S8890A	2	INTEGRATED CKT, (V18324) 351-7465-110 A9U62		1
23	1N914	2	SEMICONV DEVICE, (V07688) 353-2906-000 A9CR2		1
24	2N6027	2	TRANSISTOR, (V07688) 352-0900-010 A9Q3		1
25	T055-121K1F	2	RESISTOR,FXD, FILM, 121K, 1%, 1/8W (V11502) 705-1454-890 A9R24		1
26	CK06BX124K	2	CAPACITOR,FXD, CER DIEI, 0.12UF, 10%, 50V (V81349) 913-5019-450 A9C4		1
27	CK05BX103K	2	CAPACITOR,FXD, CER DIEI, 0.01UF, 10%, 100V (V81349) 913-5019-200 A9C5		1
28	RCR07G472KS	2	RESISTOR,FXD, CMPSN, 4.7K, 10%, 1/4W (V81349) 745-0773-000 A9R25		1
29	T055-3-16K1F	2	RESISTOR,FXD, FILM, 3.16K, 1%, 1/8W (V11502) 705-1454-510 A9R22		1
30	2N2222A	2	TRANSISTOR, (V81350) 352-7500-280 A9Q2		1
31	T055-7-5K1F	2	RESISTOR,FXD, FILM, 7.5K, 1%, 1/8W (V11502) 705-1454-600 A9R23		1
32	8121-050-651-104 Z	2	CAPACITOR,FXD, CER DIEI, 0.1UF, M20XP80X, 50V (V72982) 913-3279-500 A9C10		1
33	RCR07G391KS	2	RESISTOR,FXD, CMPSN, 390 OHMS, 10%, 1/4W (V81349) 745-0734-000 A9R32		1
34	150D105X9035A2	2	CAPACITOR,FXD, ELCTLT, 1UF, 10%, 35V (V5A289) 184-7697-000 A9C12		1

## GROUP ASSEMBLY PARTS LIST

FIG - ITEM	PART NO	INDENT	DESCRIPTION	USABLE ON CODE	UNITS PER ASSY
41	35	RCR07G102KS	2 RESISTOR,FXD, CMPSN, 1K, 10%, 1/4W (V81349) 745-0749-000 A9R17		1
36	S8280A		2 INTEGRATED CKT, (V18324) 351-7510-010 A9U71		1
37	S8280A		2 INTEGRATED CKT, (V18324) 351-7510-010 A9U61		1
38	RCR07G472KS		2 RESISTOR,FXD, CMPSN, 4.7K, 10%, 1/4W (V81349) 745-0773-000 A9R10		1
39	RCR07G472KS		2 RESISTOR,FXD, CMPSN, 4.7K, 10%, 1/4W (V81349) 745-0773-000 A9R11		1
40	RCR07G472KS		2 RESISTOR,FXD, CMPSN, 4.7K, 10%, 1/4W (V81349) 745-0773-000 A9R12		1
41	RCR07G472KS		2 RESISTOR,FXD, CMPSN, 4.7K, 10%, 1/4W (V81349) 745-0773-000 A9R28		1
42	RCR07G472KS		2 RESISTOR,FXD, CMPSN, 4.7K, 10%, 1/4W (V81349) 745-0773-000 A9R27		1
43	RCR07G472KS		2 RESISTOR,FXD, CMPSN, 4.7K, 10%, 1/4W (V81349) 745-0773-000 A9R26		1
44	RCR07G472KS		2 RESISTOR,FXD, CMPSN, 4.7K, 10%, 1/4W (V81349) 745-0773-000 A9R8		1
45	RCR07G472KS		2 RESISTOR,FXD, CMPSN, 4.7K, 10%, 1/4W (V81349) 745-0773-000 A9R6		1
46	RCR07G472KS		2 RESISTOR,FXD, CMPSN, 4.7K, 10%, 1/4W (V81349) 745-0773-000 A9R9		1
47	RCR07G472KS		2 RESISTOR,FXD, CMPSN, 4.7K, 10%, 1/4W (V81349) 745-0773-000 A9R5		1
48	RCR07G472KS		2 RESISTOR,FXD, CMPSN, 4.7K, 10%, 1/4W (V81349) 745-0773-000 A9R4		1
49	RCR07G472KS		2 RESISTOR,FXD, CMPSN, 4.7K, 10%, 1/4W (V81349) 745-0773-000 A9R7		1
50	S8280A		2 INTEGRATED CKT, (V18324) 351-7510-010 A9U51		1
51	RCR07G472KS		2 RESISTOR,FXD, CMPSN, 4.7K, 10%, 1/4W (V81349) 745-0773-000 A9R3		1
52	RCR07G472KS		2 RESISTOR,FXD, CMPSN, 4.7K, 10%, 1/4W (V81349) 745-0773-000 A9R1		1
53	RCR07G472KS		2 RESISTOR,FXD, CMPSN, 4.7K, 10%, 1/4W (V81349) 745-0773-000 A9R2		1
54	CK05BX122K		2 CAPACITOR,FXD, CER DIEI, 1200PF, 10%, 100V (V81349) 913-5019-090 A9C2		1
55	CK05BX122K		2 CAPACITOR,FXD, CER DIEI, 1200PF, 10%, 100V (V81349) 913-5019-090 A9C3		1
56	S8822A		2 INTEGRATED CKT, (V18324) 351-7465-090 A9U41		1
57	8111-050-651-472 M		2 CAPACITOR,FXD, CER DIEI, 4700PF, 20%, 50V (V72982) 913-3279-090 A9C11		1
58	RCR07G221KS		2 RESISTOR,FXD, CMPSN, 220 OHMS, 10%, 1/4W (V81349) 745-0725-000 A9R30		1
59	CK06BX474K		2 CAPACITOR,FXD, CER DIEI, 0.47UF, 10%, 50V (V81349) 913-5019-520 A9C1		1
60	S8880A		2 INTEGRATED CKT, (V18324) 351-7465-030 A9U31		1
61	1N914		2 SEMICOND DEVICE, (V07688) 353-2906-000 A9CR1		1
62	RCR07G221KS		2 RESISTOR,FXD, CMPSN, 220 OHMS, 10%, 1/4W (V81349) 745-0725-000 A9R18		1
63	B5171-150-2G		2 CLIP,ELEC, (V29593) 367-1508-010		16
64	372-2601-037		2 CONTACT,ELEC, 372-2601-037		33
65	372-2234-020		2 CONTACT,ELEC, (V13499) 372-2234-020		23
66	372-2234-010		2 CONTACT,ELEC, (V13499) 372-2234-010		30
67	372-2621-015		2 HOUSING,CONN, 372-2621-015		1
68	372-2623-033		2 HOUSING,CONN,EL, 372-2623-033		1
69	783-9515-001		2 HANDLE		1
	MS16562-199		2 PIN,SPR, SST, 0.078 DIA X 1/4 (V96906) 311-0355-000 (AP)		1

GROUP ASSEMBLY PARTS LIST

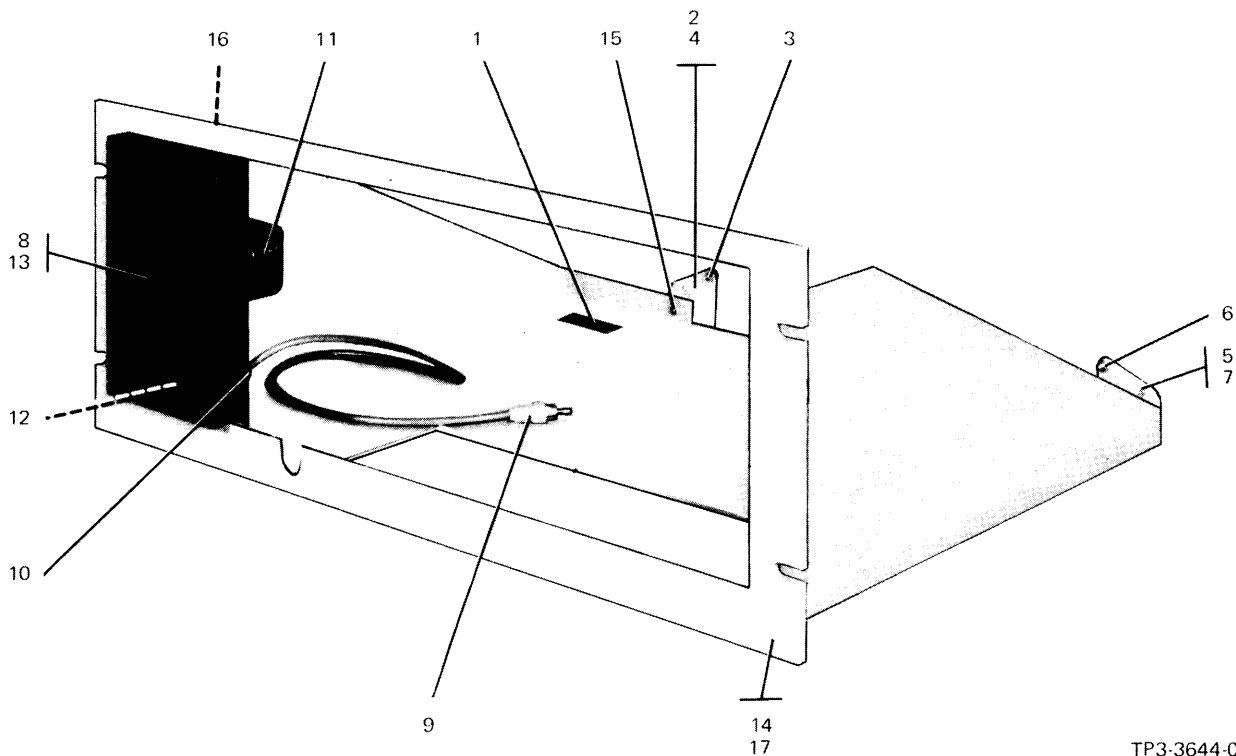

TP3-3644-017

699J-1 Receiver Adapter  
Figure 42

FIG - ITEM	PART NO	INDENT	DESCRIPTION	USABLE ON CODE	UNITS PER ASSY
42 "	792-6980-001		1 ADAPTER, RECEIVER 699J-1 (SEE FIG 1-45 FOR NHA)		RF
1	778-6825-001		2 PLATE, IDENT		1
2	609-0307-001		2 RETAINER ASSY, RECEIVER		1
	MS51957-29		2 SCREW, MACH, SST, 6-32 X 7/16 (V96906)		1
	310-6360-000		2 WASHER, FLAT, SST, 0.147 ID X 0.375 OD (V79807)		1
3	609-0307-003		3 DOWEL, SHOULDERED		1
4	609-0307-004		3 RETAINER		1
5	609-0307-002		2 RETAINER ASSY, RECEIVER		1
	MS51957-29		2 SCREW, MACH, SST, 6-32 X 7/16 (V96906)		1
	310-6360-000		2 WASHER, FLAT, SST, 0.147 ID X 0.375 OD (V79807)		1
6	609-0307-003		3 DOWEL, SHOULDERED		1
7	609-0307-004		3 RETAINER		1
8	609-0561-001		2 PANEL ASSY, LOUDSPEAKER		1
	MS35649-244		2 NUT, PLAIN, HEX, SST, 4-40 (V96906) 313-0043-000 (AP)		4
	MS35338-135		2 WASHER, LOCK, SST, 0.115 ID X 0.209 OD (V96906)		4
	310-0447-000		2 WASHER, FLAT, SST, 0.147 ID X 0.437 OD (V79807)		4
	310-0045-000		2 WASHER, FLAT, SST, 0.125 ID X 0.312 OD (V79807)		4

GROUP ASSEMBLY PARTS LIST

FIG - ITEM	PART NO	INDENT	DESCRIPTION	USABLE ON CODE	UNITS PER ASSY
42	9 7943-22	3	CABLE ASSY, (V12127) 426-0048-010		1
	10 422-04-22-034-11	3	STRAP, RTNG, (V71785) 139-0647-000		1
		3			
	11 X8014-1	3	LOUDSPEAKER, PM, (V14208) 271-0250-010		1
	MS51957-27	3	SCREW, MACH, SST, 6-32 X 5/16 (V96906)		4
			343-0168-000 (AP FOR 10,11)		
	MS35338-136	3	WASHER, LOCK, SST, 0.141 ID X 0.250 OD (V96906)		4
			310-0282-000 (AP FOR 10,11)		
	310-0046-000	3	WASHER, FLAT, SST, 0.147 ID X 0.312 OD (V79807)		3
			310-0046-000 (AP FOR 10,11)		
	12 609-0920-001	3	SHIELD, LIGHT		1
	13 609-0557-001	3	PANEL, SPEAKFR		1
	14 609-0560-001	2	ADAPTER, PRSD		1
	15 F12NCFMA2-62	3	NUT, SLFLKG, CD PL STL, 6-32 (V72962)		2
			333-0842-000		
	16 CFHS440-6	3	STUD, CAPTIVE-SE, SST, 4-40 X 3/8 (V46384)		4
			330-4923-000		
	17 609-0303-001	3	ADAPTER, BRAZED		1

3. NUMERICAL INDEX

PART NUMBER	FIG - ITEM	TTL REQ	PART NUMBER	FIG - ITEM	TTL REQ
AB404D	36-26L	1			
AB406D	27-19	2		2-97	1
	30-41	6		2-108	1
AN565D4L2	1-32	14		2-118	1
	1-32	12		2-123	1
	1-32B	4		2-124	1
AV936A416B	39-8	1		2-129	1
	40-58	1		11-29	1
A074675	40-3	1		11-33	1
A189	16-63	1		11-50	1
	36-26	1		11-105	1
	40-51	1		11-107	1
A216	16-151	1		11-126	1
A217	16-150	1		32-9	1
A249	21-104	1		32-16	1
	22-99	1		32-30	1
A251	16-10	1		32-37	1
A252	16-11	1		32-46	1
A253	16-12	1		32-54	1
A254	16-13	1		32-59	1
A255	16-14	1		32-69	1
A256	16-15	1		32-72	1
A257	16-16	1		32-83	1
A258	16-17	1		32-105	1
A259	38-30	1	CK05BX104K	11-56	1
A260	16-147	1		11-66	1
	37-4	1		11-71	1
A261	19-66	1		11-73	1
A263	19-144	1		11-75	1
A264	21-54	1		11-77	1
	22-48	1	CK05BX104M	2-104	1
A265	21-86	1		11-8	1
	22-5	1		11-38	1
A266	21-242	1		11-80	1
A275	16-9	1		11-84	1
	38-43	1		11-90	1
A284	37-49	1		11-91	1
A289	32-113	1		11-129	1
	32-114	1		11-147	1
A296	16-152	1	CK05BX122K	41-54	1
BA178003	39-61	1		41-55	1
B5171-150-2G	4-118	2	CK05BX273K	6-5	1
	12-90	1	CK05BX471K	4-25	1
	31-114	2	CK05BX683K	21-145	1
	41-63	16	CK06BX104K	3-16	1
CB1028	24-3	1		3-18	1
CFHS440-6	42-16	4		3-29	1
CF81	11-5	1		3-34	1
	11-79	1	CK06BX104M	14-5	1
CK05BX102K	2-107	1		14-17	1
	4-61	1		14-27	1
CK05BX102M	2-56	1		14-32	1
CK05BX103K	6-1	1		14-39	1
	6-2	1		14-42	1
	6-30	1		14-48	1
	41-27	1		14-82	1
CK05BX103M	2-7	1		14-99	1
	2-17	1	CK06BX124K	41-26	1
	2-20	1	CK06BX222K	4-26	1
	2-28	1	CK06BX394K	24-10	1
	2-36	1	CK06BX474K	41-59	1
	2-40	1	CM04FN181J03	24-1	1
	2-47	1	CM05FD101J03	3-3	1
	2-92	1		3-24	1
			CM05FN301J03	38-27	1



NUMERICAL INDEX

PART NUMBER	FIG - ITEM	TTL REQ	PART NUMBER	FIG - ITEM	TTL REQ
C405FD391J03	38-27	1		11-26	1
	38-27	1		11-41	1
C406FD472J03	12-4	1	C3103K	3-38	1
	12-49	1		3-48	1
C406FD511J03	24-78	1	C3112G	11-17	1
C406FD621J03	22-183	1	C3133G	11-123	1
C406FD821J03	22-155	1		11-124	1
C439-04-5	39-75	2	C3152G	11-116	1
C22A102M	16-157	1		11-117	1
	16-160	1	C3153G	11-61	1
	16-161	1	C3183G	11-144	1
	16-165	1	C3272G	11-60	1
	16-168	1	C3333K	3-43	1
	16-172	1	C3431G	11-22	1
	16-196	1	C3471G	11-131	1
C22A103K	16-105	1		11-132	1
	16-127	1	C3472K	3-45	1
	16-133	1	C3560G	11-135	1
	17-1	1	C3682K	3-39	1
	17-3	1		3-49	1
	17-5	1	C3752G	11-89	1
	17-6	1		11-142	1
	17-8	1	C4344-207-4	40-10	1
	17-10	1	DA934-023	32-3	AR
	17-12	1		32-15	AR
	17-18	1		33-33	AR
	17-19	1		33-47	AR
	17-21	1	DA934-024	32-3	AR
	17-24	1		32-15	AR
	17-29	1		33-33	AR
	17-31	1		33-47	AR
	17-47	1	DA934-025	32-3	AR
	17-48	1		32-15	AR
	17-51	1		33-33	AR
	17-54	1		33-47	AR
	17-57	1	DIE30071	16-78	AR
	17-62	1		36-22	AR
	17-64	1	DM115	24-47	1
	17-70	1		24-51	1
	17-75	1	DM5C010D050WV	16-82A	1
	17-80	1	DM5C030D050WV	4-22	1
	17-85	1		4-71	1
	17-92	1		4-92	1
	17-108	1		11-6	1
	17-110	1		31-29	1
	17-112	1		31-91	1
	17-115	1	DM5C050D050WV	11-108	1
	17-117	1	DM5C080D050WV	18-54	1
C22A103M	8-2	1	DM5C100D050WV	4-97	1
	9-3	1		4-105	1
C22C104M	17-23	1		31-33	1
	17-30	1		31-94	1
	17-38	1		31-104	1
	17-41	1	DM5C120D050WV	37-5	1
	17-44	1		37-6	1
	17-69	1	DM5C150D050WV	11-9	1
	17-97	1		18-55	1
	17-98	1	DM5C180D050WV	19-85	1
	17-99	1		19-170	1
	17-100	1		19-182	1
	17-105	1	DM5E200D050WV	32-3	AR
C3102G	11-97	1		32-15	AR
	11-100	1		32-17	AR
	11-102	1		32-96	1
C3103G	11-24	1		33-33	AR

NUMERICAL INDEX

PART NUMBER	FIG - ITEM	TTL REQ	PART NUMBER	FIG - ITEM	TTL REQ	
DM5E240DJ050WV	33-38	AR	DM5F1A1J050WV	33-11A	1	
	33-47	AR		33-59	1	
	19-158	1		32-7	1	
	19-162	1		32-86	1	
	32-17	AR		33-37	1	
	32-53	1		2-102	1	
	33-32	1		2-106	1	
	33-38	AR		2-120	1	
	37-141	1		DM5F271J050WV	30-10	1
	37-148	1		32-103	1	
DM5E270J050WV	19-72	1	33-36	1		
	19-154	1	DM5F301J050WV	37-54	1	
	19-195	1	37-61	1		
	32-17	AR	37-70	1		
DM5E300J050WV	33-38	AR	37-77	1		
	11-55	1	37-90	1		
	32-17	AR	DM5F331J050WV	4-5	1	
DM5E330J050WV	33-38	AR	6-32	1		
	32-17	AR	6-33	1		
	32-35	1	21-130	1		
DM5E360J050WV	33-38	AR	22-131	1		
	32-17	AR	25-53	1		
DM5E430J050WV	33-38	AR	25-55	1		
	18-56	1	DM5F361J050WV	32-4	1	
	22-88	1	32-75	1		
	23-101	1	33-76	1		
	25-136	1	33-83	1		
	32-17	AR	DM5F391J050WV	2-87	1	
DM5E510J050WV	33-38	AR	2-88	1		
	18-56	1	2-91	1		
	DM5E560J050WV	32-39	1	2-93	1	
	DM5E620J050WV	4-79	1	2-99	1	
	DM5E680J050WV	18-8	1	2-100	1	
	18-10	1	DM5F401J050WV	32-58	1	
	22-89	1	32-67	1		
	23-98	1	33-26	1		
	25-138	1	33-35	1		
	32-38	1	DM5F910J050WV	18-20	1	
DM5F101J050WV	16-100	1	18-21	1		
	16-101	1	DM7486N	12-75	1	
	18-20	1	DT1704C	1-25	1	
	18-21	1	1-26	1		
	19-129	1	1-27	1		
	19-202	1	1-28	1		
	21-244	1	1-29	1		
	32-12	1	1-30	1		
	33-73	1	D71F102J0	18-24A	1	
	37-44	1	D71F152J0	19-205	1	
	37-47	1	19-207	1		
	DM5F151J050WV	16-162	1	21-48	1	
		16-174	1	22-38	1	
16-189		1	D71F511G0	24-27	1	
16-198		1	D71F621J0	21-93	1	
31-103		1	D71F821J0	21-98	1	
37-24		1	21-241	1		
37-59		1	32-94	1		
37-65		1	32-97	1		
37-102		1	E50008-051	40-70	1	
37-133		1	FHS440-4	40-67	2	
37-143		1	FN2173	16-98	1	
37-140		1	16-99	1		
DM5F171J050WV	37-145	1	16-108	1		
	16-132	1	37-17	1		
	37-119	1	37-48	1		

## NUMERICAL INDEX

PART NUMBER	FIG - ITEM	TTL REQ	PART NUMBER	FIG - ITEM	TTL REQ
	37-117	1		38-27A	1
FTSM52WHT	16-73	1	MCT2	12-27	1
F12NCFMA2-62	42-15	2		12-28	1
F22NCFMA2-40	38-58	4	MC1435G	22-172	1
F5379	11-30	1		23-105	1
GEL246S1	29-28	1		25-6	1
G111SPDT	39-26	1		25-129	1
G2619	39-80	4	MC1596G	32-44	1
	39-133	16		33-92	1
G544BX102M	2-130	1	MC7400P	4-9	1
HP10N	26-2	1		12-8	1
HP8N	26-3	1		12-13	1
HTA	40-57	2		12-73	1
H25	33-100	1		12-74	1
JT02A14-37PA014	39-18	1		12-85	1
JT02A14-37P014	39-19	1		31-109	1
K05SK102M	19-67	1		34-24	1
	19-145	1		35-6	1
	19-146	1	MC7401P	4-16	1
	19-148	1		31-3	1
	20-22	1	MC7402P	4-17	1
	21-15	1		12-64	1
	21-20	1		12-76	1
	21-95	1		12-80	1
	21-114	1		12-84	1
	21-134	1		12-89	1
	21-206	1		31-1	1
	22-11	1	MC7404P	4-7	1
	22-147	1		12-5	1
	22-159	1		12-78	1
	22-173	1		31-60	1
	22-205	1		34-6	1
	22-228	1		35-8	1
	22-237	1		35-24	1
	23-100	1		35-27	1
	23-106	1		35-28	1
	25-124	1		35-29	1
	25-179	1		35-30	1
	29-25	1		35-34	1
K1P35	2-54	1	MC7410P	12-15	1
LL51959-12	1-39	2		12-21	1
LM101AF	11-7	1	MC7420P	34-5	1
	11-35	1		35-7	1
	11-109	1	MC7493P	12-88	1
	11-125	1	MC836P	12-19	1
LM101F	11-10	1	MC946F	2-2	1
	11-25	1		2-3	1
	11-138	1		2-30	1
LM103H3-9	11-19	1		2-39	1
	11-139	1		2-42	1
LM104H	3-15	1		2-45	1
LM301AH	31-46	1	MDL1 1-2	40-55	1
	31-63	1		40-56	1
	31-75	1	MH745	40-8	2
	31-76	1	MS16535-152	40-70	2
LM311H	4-50	1	MS16535-77	24-82	6
	4-69	1	MS16562-199	2-134	1
	4-70	1		12-92	1
LP9A1B103F	11-23	1		15-89	1
	11-59	1		34-34	1
LP9A1B333F	11-11	1		35-40	1
	11-20	1		41-69	1
LT4K036	38-26A	1	MS171473	4-123	1

NUMERICAL INDEX

PART NUMBER	FIG - ITEM	TTL REQ	PART NUMBER	FIG - ITEM	TTL REQ
MS18130-19	5-23	1		37-49	2
MS20426AD2-3	40-66	4		37-51	2
MS21266-1N	40-54	AR		37-152	1
MS24515-685	39-7	1		39-22	2
MS35333-69	37-34	3		39-79	4
	37-49	2		40-18	2
	37-51	4	MS35649-244	40-38	2
	37-152	1		16-63	2
	37-153	3		27-18	2
MS35333-73	26-6	4		29-7	2
MS35338-134	39-64	3		36-26	2
	39-66	1		40-6	4
	40-18	2		40-9	2
	40-36	2		40-53	1
	40-38	2		42-8	4
MS35338-135	1-18	4	MS35649-284	26-12	4
	1-38	3	MS51923-156	13-35	1
	16-4	1	MS51923-314	3-60	1
	16-56	1		5-28	1
	16-61	3		6-63	1
	16-63	2		8-54	1
	16-219	3		9-61	1
	16-237	2		11-150	1
	26-77	6		19-223	1
	29-7	2		20-65	1
	36-5	3		21-253	1
	36-20	2		22-244	1
	36-23	1		23-119	1
	36-25	3		24-83	1
	36-26	2		25-186	1
	39-36	6	MS51923-315	31-113	1
	39-136	2		14-172	1
	39-139	3	MS51957-10	16-60	2
	40-6	4		16-225	2
	40-9	2		36-8	2
	40-53	1		36-31	2
	42-8	4	MS51957-12	1-8	12
MS35338-136	39-138	2		26-77	6
	42-11	4	MS51957-13	16-4	1
MS35338-137	26-12	4		16-56	1
MS35338-96	16-64	2		16-61	3
	16-73	2		16-219	3
	16-82	2		16-237	2
	27-19	2		20-1	2
	36-3	2		26-16	2
	36-19B	2		27-20	1
	36-26A	2		36-5	3
	36-26K	2		36-20	2
	36-26L	1		36-23	1
	40-29	2		36-25	3
	40-30	2		36-27	2
MS35338-97	27-18	2		38-30	1
	29-12	2		38-53A	
	30-39	4		39-5	1
	30-40	2		39-36	6
	38-30	2		39-65	1
	38-43	1		39-139	3
	38-53A		MS51957-14	20-1	2
MS35649-224	27-19	2		26-16	2
	33-100	2		29-12	2
	37-34	3		36-23	1
	37-35	1		39-20	11

## NUMERICAL INDEX

PART NUMBER	FIG - ITEM	TTL REQ	PART NUMBER	FIG - ITEM	TTL REQ
	39-20	7		16-226	2
	39-131	7		16-238	4
	40-17	7		36-11	2
MS51957-15	40-53	1		36-52B	4
	1-8	4		39-5	1
	1-18	4	MS51959-7	40-38	2
	27-18	2	MS51963-114	1-33	2
	39-20	1	MS75083-03	37-88	1
MS51957-16	40-11	8	MS75083-09	6-52	1
	24-41	2		16-170	1
	24-47	2		16-200	1
	24-51	2		37-22	1
MS51957-17	29-7	2		37-57	1
	40-6	4		37-71	1
	40-9	2	MS75084-02	6-31	1
MS51957-2	16-64	2	MS75084-07	8-35	1
	16-73	2		8-45	1
	16-86	2		8-50	1
	23-1	6		9-1	1
	25-1	6		9-41	1
	32-114	8		9-53	1
	36-26A	2	MS75084-08	6-49	1
	36-26K	2	MS75084-12	18-13	1
	39-64	3		37-67	1
	39-66	1		37-84	1
	40-30	2		37-139	1
MS51957-26	1-1	2		37-144	1
MS51957-27	42-11	4	MS75084-16	6-23	1
MS51957-28	39-138	2		6-28	1
MS51957-29	42-2	1	MS75084-17	18-34	1
	42-5	1	MS75085-03	16-126	1
MS51957-3	16-183	2		16-129	1
	16-207	2		37-111	1
	33-1	4		37-121	1
	37-34	3		37-130	1
	37-35	1	MS75085-07	16-103	1
	37-49	2		37-43	1
	37-51	2	MS75085-11	32-49	1
	37-152	1		32-81	1
	37-153	3		33-21	1
	40-29	2		33-25	1
MS51957-31	26-8	2	MS90537-25	16-70	1
MS51957-43	26-12	3		36-26E	1
MS51957-44	26-12	1	MS90537-37	36-9	1
MS51957-8	23-5	2		36-9	1
	25-117	2		36-10	1
MS51957-9	33-100	2		36-10	1
MS51959-11	18-1	3	MS90537-41	3-19	1
MS51959-12	33-99	4		3-36	1
	39-72	2		16-220	1
	39-136	2		16-221	1
MS51959-13	1-39	18		18-42	1
	39-17	4		18-43	1
	39-36	6		21-99	1
MS51959-14	1-39	8		22-184	1
	39-5	1		32-26	1
	39-73	6		32-29	1
	39-140	1		32-76	1
MS51959-2	16-82	2		33-50	1
	16-83	2		33-57	1
	36-3	2		33-91	1
	36-19B	2		36-9	1
MS51959-3	16-18	2		36-10	1

NUMERICAL INDEX

PART NUMBER	FIG - ITEM	TTL REQ	PART NUMBER	FIG - ITEM	TTL REQ
MS90537-48	33-14	1		17-107	1
MS90537-49	16-30	1		17-109	1
	19-157	1		17-111	1
	22-17	1		17-113	1
	22-23	1		38-6	1
	22-44	1		38-11	1
	22-53	1		38-15	1
	22-61	1		38-20	1
	22-62	1	MS90539-15	38-22	1
	22-81	1		21-26	1
	28-12	1		21-33	1
	36-45	1		21-51	1
MS90537-60	32-90	1		21-57	1
	33-62	1		21-64	1
MS90538-04	19-10	1		21-65	1
	19-58	1		21-81	1
	19-112	1		21-120	1
	19-137	1		21-195	1
	20-27	1		22-170	1
	20-33	1		22-212	1
	20-38	1		23-78	1
	20-59	1	MS90540-08	25-135	1
MS90538-06	16-19	1		21-173	1
	16-20	1		22-230	1
	16-21	1	MV1404	32-13	1
	16-22	1		32-55	1
	16-23	1		33-30	1
	16-24	1		33-46	1
	16-25	1	M2-542-3	37-160	10
	16-26	1		38-57	6
	16-27	1		38-57	7
	16-28	1	M39003-01-2003	14-53	1
	16-29	1	M39003-01-2005	22-93	1
	16-227	1	M39003-01-2014	2-64	1
	16-228	1		2-117	1
	16-229	1	M39003-01-2015	21-224	1
	36-14	1		22-86	1
	36-15	1		26-17	1
	36-15A	1	M39003-01-2018	6-22	1
	36-43	1		14-56	1
	36-44	1	M39003-01-2022	24-54	1
	36-45A	1		25-73	1
	36-45B	1	M39003-01-2026	26-18	1
	38-1	1		29-14	1
	38-25	1	M39003-01-2029	5-22	1
MS90538-10	17-4	1		6-11	1
	17-7	1		6-14	1
	17-9	1		6-22	1
	17-61	1		6-25	1
	17-63	1		6-53	1
	17-65	1		8-1	1
MS90538-20	17-11	1		8-37	1
	17-14	1		8-43	1
	17-17	1		9-2	1
	17-20	1		9-44	1
	17-22	1		9-52	1
	17-27	1		16-175	1
	17-28	1		16-199	1
	17-68	1		19-6	1
	17-95	1		21-55	1
	17-96	1		27-10	1
	17-106	1		37-15	1

## NUMERICAL INDEX

PART NUMBER	FIG - ITEM	TTL REQ	PART NUMBER	FIG - ITEM	TTL REQ
	37-146	1		3-20	1
M39003-01-2032	12-72	1		3-20A	1
M39003-01-2039	21-117	1	M39012-21-0001	40-59	1
	21-117	1		40-60	1
	21-117	1		40-61	1
M39003-01-2043	21-117	AR		40-62	1
	11-36	1	M5-540-3	37-157	7
	11-141	1		40-46	1
	31-10	1	M5757-9-027	33-98	1
M39003-01-2044	2-14	1	NAS1068A06	40-66	2
	21-198	1	N8233R	14-20	1
	21-225	1		14-23	1
	22-196	1		14-25	1
	22-216	1		14-28	1
	23-65	1	NA263P	8-40	1
	25-140	1		8-48	1
M39003-01-2047	21-69	1		9-47	1
	21-183	1		9-56	1
	22-2	1	N8266R	14-18	1
	22-52	1	N8280J	6-26	1
	22-69	1		8-20	1
	22-168	1		9-23	1
M39003-01-2050	3-10	1	N8281J	6-21	1
	3-20	1	N82920	6-10	1
	3-22	1		6-15	1
	3-33	1	N82930	6-18	1
	3-35	1		6-20	1
	39-39	1	NA424J	6-34	1
M39003-01-2056	21-84	1		6-45	1
	22-1	1	PT02A16-8P	39-20	1
M39003-01-2065	6-51	1	P313-0050-000	29-28	2
	23-15	1		29-34	3
	25-158	1		30-41	6
M39003-01-2067	21-239	1	P313-0051-000	30-39	4
	22-189	1		30-40	2
	29-23	1	P313-0053-000	40-4	4
M39003-01-2070	29-29	1		40-52	1
M39003-01-2073	4-103	1	P313-0056-000	40-8	1
	4-104	1	P313-0132-000	1-38	3
	24-55	1		16-17	18
	24-62	1		20-23	2
M39003-01-2102	4-42	1		20-35	2
M39003-01-2108	24-15	1		24-41	2
	29-31	1		24-47	2
M39003-01-2111	18-52	1		24-51	2
	21-165	1		33-99	4
	22-157	1		38-30	2
	23-28	1		38-43	2
	23-34	1		38-53A	2
	23-93	1		39-23	2
	25-30	1		39-65	1
	25-92	1		39-131	7
	25-93	1		39-136	2
	40-48	1	P313-0140-000	40-10	1
M39003-01-2116	11-99	1	P313-0156-00	29-12	2
M39003-01-2117	21-117	AR		40-51	2
M39003-01-2135	23-80	1		40-64	8
	25-167	1		40-64	4
M39003-03-0015	30-6	1	P313-0166-000	32-107	2
M39003-03-0024	3-8	1	P313-0484-010	16-74	1
	3-9	1		36-26K	1
	3-21	1		36-26L	1
M39003-03-0045	30-13	1	P321-0297-000	32-107	2
M39003-03-0059	3-10	1	P330-2284-000	16-1	10

NUMERICAL INDEX

PART NUMBER	FIG - ITEM	TTL REQ	PART NUMBER	FIG - ITEM	TTL REQ
	16-80	9	P347-0009-000	40-64	8
	16-80	15		40-64	4
	36-2	9	P347-0022-000	39-12	5
	36-19A	6	P347-0103-000	16-83	4
	36-21	10		36-3	2
	39-34	10	P347-1269-000	39-22	2
P330-2290-000	16-4	2		39-79	4
	16-63	2	RA20SASD252A	39-60	1
	33-99	4	RCCS250437-1A	14-155	7
	36-23	2	RCCS250437-2A	14-155A	3
	36-26	2	RCCS250437-3A	14-155R	3
P330-2292-000	39-136	2	RCCS250437-4A	14-155C	1
P330-3059-020	3-17	4	RCRP800060-2A	14-137	1
	3-37	4		24-65	2
	3-46	4	RCR05G100JS	16-104	1
	3-47	4		16-107	1
	5-20	8		16-122	1
	6-42	4		16-131	1
	6-43	4		16-171	1
	6-60	1		18-11	1
P330-3059-030	6-60	1		18-12	1
P334-0287-00	39-63	1		18-17	1
P334-4060-000	39-25	2		18-18	1
	39-63	5		37-46	1
	39-63	4		37-53	1
P334-4121-00	39-70	1		37-56	1
P342-0142-000	32-2	5		37-72	1
	39-26	2		37-73	1
	39-71	2		37-114	1
P342-0143-000	16-81	2		37-118	1
	36-2	2		37-131	1
P342-0147-000	40-36	2	RCR05G100K	3-2	1
P342-0149-000	16-60	2		3-31	1
	16-225	2		6-4	AR
P342-0152-000	40-51	2		6-35	AR
P343-0285-000	26-19	3	RCR05G101JS	16-137	1
	26-70	1		37-1	1
	26-78	8		37-92	1
P343-0286-000	26-3	2		37-142	1
	40-13	2	RCR05G101K	2-61	1
P343-0287-000	30-39	4		6-4	AR
	30-40	2		6-35	AR
	30-40	6	RCR05G102JS	16-113	1
P343-0290-000	26-1	2		19-159	1
P343-0297-000	36-3	1		37-19	AR
P343-0298-000	16-82	2		37-39	1
	16-83	4	RCR05G102K	2-11	1
	29-28	2		2-19	1
	29-34	3		2-63	1
	36-3	3		2-79	1
	36-3	4		4-72	1
	36-19B	2		4-73	1
	39-2	4		4-83	1
	39-4	4		4-112	1
	39-9	2		4-115	1
P343-0299-000	39-28	2		14-13	1
P343-0330-000	40-35	4		14-63	1
	40-52	1		14-86	1
P343-0331-000	40-2	4		14-116	1
P343-0332-000	40-4	4		14-118	1
P343-0343-000	26-6	2		14-134	1
P343-0345-000	26-6	2		14-135	1



NUMERICAL INDEX

PART NUMBER	FIG - ITEM	TTL REQ	PART NUMBER	FIG - ITEM	TTL REQ
	14-163	1		3-12	AR
	14-165	1		3-32	AR
	14-168	1		14-15	1
	28-6	1		14-22	1
	28-7	1		14-127	1
	31-68	1		14-128	1
	31-74	1		33-60	1
	31-77	1	RCR05G133JS	32-5	1
	31-78	1		32-66	1
	31-87	1		33-77	1
	32-62	1		33-84	1
	32-79	1	RCR05G150K	3-14	1
	32-80	1		6-4	AR
	32-91	1		6-35	AR
	33-19	1	RCR05G151K	4-10	1
	33-64	1		6-4	AR
	33-79	1		6-35	AR
	33-97	1		31-111	1
RCR05G103JS	16-82B	AR		32-18	1
	18-7	1	RCR05G152JS	16-125	1
	18-14	1		37-60	1
RCR05G103K	2-74	1		37-69	1
	2-75	1	RCR05G152K	4-43	1
	3-1	AR		4-48	1
	3-12	AR		4-90	1
	3-32	AR		4-106	1
	3-38	1		31-18	1
	3-48	1		31-39	1
	4-21	1		33-18	AR
	4-51	1	RCR05G153JS	16-82B	AR
	11-110	1		32-6	1
	24-49	1		32-11	1
	31-8	1		33-39	1
	31-58	1		33-82	1
	31-61	1		39-82	1
	32-21	1		39-83	1
	32-56	1		39-84	1
	32-64	1		39-85	1
	32-92	1		39-86	1
	33-3	1		39-87	1
	33-6	1		39-88	1
	33-28	1		39-89	1
	33-42	1		39-90	1
	33-53	1		39-91	1
	33-55	1		39-92	1
RCR05G104JS	11-44	1		39-93	1
	37-98	1		39-94	1
RCR05G104K	2-71	1		39-95	1
	4-86	1		39-96	1
	4-91	1		39-97	1
	31-31	1		39-98	1
	31-90	1		39-99	1
RCR05G120K	6-4	AR		39-100	1
	6-35	AR		39-101	1
RCR05G121K	6-4	AR		39-102	1
	6-35	AR		39-103	1
	14-54	1		39-104	1
	14-58	1		39-105	1
RCR05G122K	32-36	AR		39-106	1
	33-18	AR		39-107	1
RCR05G123JS	16-82B	AR		39-109	1
RCR05G123K	2-72	1		39-110	1
	3-1	AR		39-111	1

NUMERICAL INDEX

PART NUMBER	FIG - ITEM	TTL REQ	PART NUMBER	FIG - ITEM	TTL REQ
	39-113	1		32-22	1
	39-114	1		32-36	AR
	39-115	1		32-47	1
	39-117	1		32-78	1
	39-118	1		32-95	1
	39-119	1		32-101	1
	39-121	1		32-102	1
	39-122	1		33-18	AR
	39-123	1		33-23	1
	39-125	1		33-56	1
	39-126	1		33-58	1
	39-128	1	RCR05G223K	33-69	1
	39-129	1		2-18	1
RCR05G153K	3-1	AR		2-43	1
	3-12	AR		2-49	1
	3-32	AR		2-52	1
	32-5	1		2-78	1
	32-5	1		2-81	1
	32-6	1		2-82	1
	32-6	1		2-83	1
	32-11	1		2-89	1
	32-11	1		2-90	1
	32-66	1		2-105	1
	32-66	1		2-119	1
	33-15	1		3-1	AR
RCR05G180K	6-4	AR		3-12	AR
	6-35	AR		3-32	AR
RCR05G181JS	37-19	AR		4-67	1
RCR05G181K	6-4	AR		31-73	1
	6-35	AR	RCR05G270K	39-60A	1
RCR05G182K	32-36	AR		2-67	1
	32-85	1		2-68	1
	33-18	AR		6-4	AR
RCR05G183K	3-1	AR		6-35	AR
	3-12	AR		11-101	1
	3-32	AR	RCR05G271JS	37-19	AR
RCR05G220JS	16-96	1	RCR05G271K	2-125	1
	37-108	1		6-4	AR
RCR05G220K	6-4	AR		6-35	AR
	6-35	AR	RCR05G272JS	11-16	1
RCR05G221JS	16-116	1		16-82B	AR
	37-19	AR		18-29	1
	37-36	1	RCR05G272K	4-82	1
RCR05G221K	6-4	AR		24-80	1
	6-35	AR		32-36	AR
	33-5	1		33-18	AR
RCR05G222JS	16-82B	AR	RCR05G273K	2-77	1
RCR05G222K	2-35	1		3-1	AR
	3-5	1		3-12	AR
	3-30	1		3-12	1
	3-51	1		3-32	AR
	14-65	1	RCR05G3R3JS	6-13	1
	14-101	1		6-17	1
	14-105	1		6-23	1
	14-107	1		6-28	1
	14-156	1	RCR05G330K	6-4	AR
	14-157	1		6-35	AR
	14-160	1	RCR05G331JS	16-112	1
	14-161	1		16-114	1
	14-163	1		16-195	1
	14-165	1		18-32	1
	14-166	1		37-19	AR

NUMERICAL INDEX

PART NUMBER	FIG - ITEM	TTL REQ	PART NUMBER	FIG - ITEM	TTL REQ
	37-37	1		18-53	1
	37-79	1		18-57	1
	37-89	1		32-65	1
	37-124	1		32-74	1
RCR05G331K	6-4	AR		33-74	1
	6-35	AR		33-86	1
	14-55	1	RCR05G472K	2-48	1
	14-59	1		2-53	1
RCR05G332JS	16-82B	AR		2-60	1
	16-97	1		2-65	1
	16-139	1		2-84	1
	37-103	1		2-85	1
	37-134	1		2-86	1
RCR05G332K	2-58	1		2-94	1
	4-2	1		2-95	1
	4-6	1		2-101	1
	4-12	1		2-112	1
	4-13	1		2-116	1
	4-52	1		3-45	1
	4-65	1		6-37	1
	4-68	1		6-46	1
	11-21	1		14-2	1
	11-94	1		14-7	1
	11-133	1		14-47	1
	11-143	1		14-65	1
	31-4	1		14-91	1
	31-49	1		14-92	1
	31-55	1		14-93	1
	31-59	1		14-94	1
	32-36	AR		14-100	1
	33-18	AR		14-101	1
RCR05G333K	3-1	AR		14-105	1
	3-1	1		14-107	1
	3-12	AR		14-140	1
	3-32	AR		14-147	1
	3-32	1		14-148	1
	32-8	1		14-149	1
	33-41	1		14-150	1
RCR05G390K	6-4	AR		14-156	1
	6-35	AR		14-157	1
RCR05G391JS	37-19	AR		14-160	1
RCR05G391K	2-131	1		14-161	1
	2-133	1		14-163	1
	24-60	1		14-165	1
RCR05G392JS	16-82B	AR		14-166	1
RCR05G392K	4-66	1		31-93	1
	32-36	AR		32-36	AR
	32-43	1		32-52	1
	32-48	1		32-65	1
	33-18	AR		32-65	1
	33-93	1		32-74	1
	33-95	1		32-74	1
RCR05G393K	3-1	AR		33-18	AR
	3-12	AR		33-27	1
	3-32	AR	RCR05G474K	32-14	1
RCR05G4R7KS	16-164	1		32-51	1
	37-74	1		32-57	1
	37-91	1		32-104	1
RCR05G470K	6-4	AR		33-29	1
	6-35	AR		33-31	1
RCR05G471K	6-39	1		33-43	1
	6-44	1		33-45	1
RCR05G472JS	16-82B	AR	RCR05G560K	4-63	1

NUMERICAL INDEX

PART NUMBER	FIG - ITEM	TTL REQ	PART NUMBER	FIG - ITEM	TTL REQ
	6-4	AR		18-48	1
	6-35	AR		19-1	1
	31-108	1		19-29	1
RCR05G561JS	37-19	AR		19-78	1
RCR05G561K	32-36	AR		19-210	1
	32-88	1		20-44	1
	32-89	1		20-64	1
	33-8	1		21-3	1
	33-9	1		21-161	1
	33-18	AR		21-197	1
RCR05G562JS	16-82B	AR		22-102	1
RCR05G562K	4-77	1		22-197	1
	14-156A	1		23-78	1
	32-36	AR		23-78	1
	33-18	AR		24-36	1
RCR05G563K	32-61	1		24-39	1
	33-40	1		24-68	1
RCR05G680JS	16-201	1		25-70	1
	37-21	1		25-135	1
	37-80	1		25-135	1
RCR05G680K	6-4	AR		30-15	1
	6-35	AR		37-82	1
	32-84	1		39-27	1
	33-20	1		41-9	1
RCR05G681K	2-57	1	RCR07G102JS	17-2	1
	24-48	1		18-6	1
RCR05G682JS	16-82B	AR		21-38	1
	16-124	1		21-83	1
	37-112	1		21-88	1
RCR05G682K	3-39	1		21-210	1
	3-49	1		21-236	1
	32-36	AR	RCR07G102KS	8-7	1
	32-41	1		9-8	1
	33-18	AR		12-30	1
	33-94	1		12-63	1
RCR05G750JS	32-42	1		13-24	1
RCR05G752JS	16-82B	AR		19-5	1
RCR05G820K	6-4	AR		19-75	1
	6-35	AR		19-79	1
RCR05G821JS	37-113	1		19-98	1
RCR05G821K	2-59	1		22-4	1
RCR05G822JS	16-82B	AR		22-28	1
	39-55	1		22-84	1
	39-56	1		23-30	1
	39-57	1		23-39	1
	39-58	1		23-87	1
RCR05G822K	14-66	1		24-33	1
	14-108	1		24-67	1
	14-109	1		25-27	1
	31-83	1		25-101	1
RCR07G100KS	14-52	1		25-112	1
	16-68	1		25-114	1
	19-114	1		25-161	1
	19-204	1		27-1	1
	19-208	1		29-26	1
	21-83	1		34-7	1
	21-201	1		34-10	1
	22-200	1		34-13	1
	29-4	1		35-9	1
	30-11	1		35-12	1
	36-26C	1		35-15	1
RCR07G101KS	12-24	1		38-38	1

NUMERICAL INDEX

PART NUMBER	FIG - ITEM	TTL REQ	PART NUMBER	FIG - ITEM	TTL REQ		
RCR07G103KS	38-47	1	RCR07G104KS	40-43	1		
	41-35	1		41-13	1		
	12-50	1		41-14	1		
	12-56	1		41-15	1		
	16-66	1		41-16	1		
	19-25	1		19-21	1		
	19-26	1		19-24	1		
	19-31	1		19-69	1		
	19-99	1		19-102	1		
	19-100	1		19-104	1		
	19-101	1		19-106	1		
	19-188	1		19-147	1		
	19-189	1		19-151	1		
	19-190	1		19-200	1		
	19-191	1		20-9	1		
	20-2	1		21-229	1		
	20-16	1		22-220	1		
	21-89	1		23-53	1		
	21-102	1		25-69	1		
	21-112	1		25-76	1		
	21-115	1		25-77	1		
	21-148	1		RCR07G105KS	21-116	1	
	21-158	1			21-116	AR	
	21-169	1			21-116	1	
	21-185	1			22-112	1	
	21-218	1			23-56	1	
	21-221	1		25-72	1		
	21-230	1		RCR07G120KS	24-4	1	
	22-14	1			RCR07G121JS	21-188	1
	22-107	1			RCR07G121KS	15-24	1
	22-110	1			15-31	1	
	22-121	1			15-55	1	
	22-139	1			15-61	1	
	22-151	1			15-69	1	
	22-160	1			15-72	1	
	22-181	1			19-209	1	
	22-213	1			19-214	1	
	22-221	1		RCR07G122KS	12-31	1	
	23-9	1			19-70	AR	
	23-13	1			19-193	AR	
	23-29	1	21-16		1		
	23-40	1	21-28		1		
	23-61	1	21-58		1		
	23-75	1	21-68		1		
	23-86	1	21-80		1		
	23-110	1	21-108		1		
	25-28	1	21-192		1		
	25-44	1	22-7	1			
	25-79	1	22-54	1			
	25-102	1	22-66	1			
	25-115	1	22-73	1			
	25-121	1	22-80	1			
	25-145	1	22-190	1			
	25-147	1	22-193	1			
	25-162	1	22-226	1			
	25-170	1	27-3	1			
	25-172	1	27-6	1			
	30-33	1	RCR07G123KS	23-24	1		
	34-4	1		23-42	1		
	34-23B	1		23-83	1		
	35-5	1		25-23	1		
	35-7A	1		25-26	1		
	36-26B	1		25-81	1		

NUMERICAL INDEX

PART NUMBER	FIG - ITEM	TTL REQ	PART NUMBER	FIG - ITEM	TTL REQ
RCR07G124JS	29-30	1	RCR07G154KS	22-140	1
	23-69	1		22-150	1
RCR07G124KS	24-5	1	22-156	1	
RCR07G133JS	25-171	1	22-162	1	
	25-12	1	25-164	1	
RCR07G150KS	21-63	1	25-43	1	
RCR07G151KS	30-7	1	25-48	1	
	12-26	1	21-116	AR	
RCR07G152KS	21-167	1	RCR07G180JS	17-25	1
	22-92	1	17-102	1	
	22-164	1	RCR07G180KS	24-30	1
	22-235	1	27-8	1	
	23-20	1	37-78	1	
	23-72	1	38-4	1	
	25-45	1	38-21	1	
	25-106	1	30-4	1	
	25-126	1	RCR07G181KS	19-70	AR
	25-173	1	RCR07G182KS	19-193	AR
	15-10	1	19-223	1	
	15-20	1	21-240	1	
	15-32	1	22-169	1	
	15-41	1	22-214	1	
	15-45	1	23-85	1	
	15-52	1	25-131	1	
	15-54	1	30-32	1	
	15-60	1	RCR07G183KS	12-20	1
	15-71	1	12-68	1	
	15-73	1	21-180	1	
16-166	1	21-186	1		
19-2	1	22-116	1		
19-50	1	24-13	1		
19-53	1	29-24	1		
19-70	AR	RCR07G185KS	21-116	AR	
19-141	1	RCR07G202JS	19-156	1	
19-193	AR	23-71	1		
19-199	1	23-102	1		
20-19	1	23-103	1		
20-49	1	25-120	1		
20-55	1	25-174	1		
21-127	1	25-181	1		
21-235	1	RCR07G220KS	18-28	1	
22-103	1	19-57A	1		
22-124	1	29-20	1		
34-16	1	37-55	1		
34-19	1	RCR07G221KS	12-38	1	
34-22	1	12-53	1		
35-18	1	12-57	1		
35-21	1	12-60	1		
35-25	1	30-20	1		
RCR07G153JS	23-68	1	30-30	1	
RCR07G153KS	12-32	1	41-58	1	
RCR07G222KS	19-91	1	41-62	1	
	21-6	1	3-41	1	
	21-111	1	3-55	1	
	21-123	1	12-52	1	
	21-149	1	15-9	1	
	21-155	1	15-13	1	
	21-157	1	15-38	1	
	21-164	1	15-42	1	
	21-166	1	15-46	1	
	22-106	1	15-51	1	
	22-108	1	15-79	1	

NUMERICAL INDEX

PART NUMBER	FIG - ITEM	TTL REQ	PART NUMBER	FIG - ITEM	TTL REQ
	15-81	1		19-164	1
	18-45	1		19-169	1
	19-3	1		19-179	1
	19-11	1		19-196	1
	19-13	1		20-5	1
	19-35	1		20-20	1
	19-36	1		21-122	1
	19-38	1		21-124	1
	19-39	1		21-126	1
	19-42	1		21-144	1
	19-43	1		21-175	1
	19-44	1		21-214	1
	19-45	1		22-117	1
	19-49	1		22-118	1
	19-51	1		22-120	1
	19-61	1		22-123	1
	19-70	AR		22-227	1
	19-193	AR		23-2	1
	20-13	1		23-113	1
	20-14	1		25-58	1
	20-43	1		25-146	1
	20-50	1		30-2	1
	20-52	1		34-2	1
	20-62	1		35-3	1
	21-43	1	RCR07G224KS	19-89	1
	21-135	1		21-147	1
	21-144	1		22-141	1
	21-202	1	RCR07G225KS	21-116	AR
	22-34	1	RCR07G270KS	18-30	1
	22-39	1		21-234	1
	22-137	1		22-224	1
	23-8	1		24-73	1
	23-32	1		27-12	1
	23-33	1	RCR07G271KS	21-136	1
	23-35	1		22-40	1
	23-36	1	RCR07G272KS	19-70	1
	23-48	1		19-70	1
	23-50	1		19-70	AR
	23-51	1		19-94	1
	23-89	1		19-176	1
	23-90	1		19-193	1
	23-91	1		19-193	1
	24-2	1		19-193	AR
	25-18	1		21-85	1
	25-64	1		21-97	1
	25-65	1		21-138	1
	25-84	1		21-191	1
	25-85	1		22-6	1
	25-86	1		22-42	1
	25-89	1		22-187	1
	25-90	1		22-190	1
	25-96	1		22-201	1
	25-97	1		24-14	1
	25-98	1	RCR07G273KS	25-11	1
	25-99	1		25-14	1
	25-156	1	RCR07G274KS	23-64	1
	30-19	1		25-175	1
	30-24	1		30-1	1
	40-42	1	RCR07G331KS	3-16A	1
RCR07G223KS	19-19	1		19-83	1
	19-33	1		19-95	1
	19-71	1		19-155	1
	19-153	1		19-165	1
				19-173	1

NUMERICAL INDEX

PART NUMBER	FIG - ITEM	TTL REQ	PART NUMBER	FIG - ITEM	TTL REQ
RCR07G332KS	19-184	1	RCR07G472KS	15-82	1
	20-8	1		19-64	1
	21-174	1		19-65	1
	21-176	1		19-117	1
	22-231	1		19-124	1
	30-16	1		19-130	1
	8-4	1		21-2	1
	8-28	1		21-11	1
	8-41	1		21-222	1
	9-5	1		22-87	1
	9-32	1		22-217	1
	9-48	1		30-9	1
	19-70	AR		30-25	1
	19-156	1		30-28	1
	19-193	AR		8-5	1
	21-202	1		9-6	1
	23-11	1		12-18	1
	25-7	1		12-23	1
	25-159	1		12-55	1
	RCR07G333KS	3-43		1	12-62
RCR07G334KS	21-46	1	19-131	1	
	22-37	1	21-1	1	
RCR07G391JS	21-96	1	21-14	1	
	22-188	1	21-91	1	
RCR07G391KS	29-8	1	21-181	1	
	19-74	1	21-203	1	
RCR07G392JS	41-33	1	22-163	1	
	11-3	1	22-175	1	
RCR07G392KS	11-81	1	22-203	1	
	19-55	1	23-55	1	
RCR07G470KS	19-56	1	23-58	1	
	19-119	1	23-92	1	
	19-120	1	24-7	1	
	20-46	1	24-19	1	
	20-47	1	24-52	1	
	20-57	1	25-63	1	
	20-58	1	25-88	1	
	21-90	1	25-105	1	
	21-191	1	25-107	1	
	21-227	1	25-180	1	
	21-247	1	29-5	1	
	22-219	1	40-39	1	
	31-71	1	41-2	1	
	12-69	1	41-8	1	
	12-70	1	41-18	1	
	18-26	1	41-21	1	
	18-47	1	41-28	1	
	19-122	1	41-38	1	
	21-12	1	41-39	1	
	21-146	1	41-40	1	
21-153	1	41-41	1		
21-160	1	41-42	1		
21-162	1	41-43	1		
21-234	1	41-44	1		
22-30	1	41-45	1		
22-146	1	41-46	1		
22-153	1	41-47	1		
22-154	1	41-48	1		
22-166	1	41-49	1		
29-13	1	41-51	1		
RCR07G471KS	15-12	1	41-52	1	
	15-39	1	41-53	1	
	15-80	1	19-20	1	
			RCR07G473KS		



## NUMERICAL INDEX

PART NUMBER	FIG - ITEM	TTL REQ	PART NUMBER	FIG - ITEM	TTL REQ
	19-32	1		22-98	1
	19-81	1		22-176	1
	19-82	1		23-26	1
	19-103	1		23-108	1
	19-105	1		25-62	1
	19-108	1		25-113	1
	20-10	1		25-163	1
	20-17	1		25-176	1
	21-45	1	RCR07G684KS	29-1	AR
	21-207	1	RCR07G750JS	23-96	1
	22-36	1		25-137	1
	22-204	1	RCR07G753JS	25-50	1
	23-74	1		29-32	1
	24-8	1	RCR07G754JS	29-1	AR
	25-59	1	RCR07G820KS	19-7	1
	25-116	1	RCR07G822KS	8-29	1
	25-168	1		8-38	1
	34-1	1		8-46	1
	34-9	1		9-33	1
	34-12	1		9-45	1
	34-15	1		9-54	1
	35-2	1		13-1	1
	35-11	1		13-27	1
	35-14	1		13-30	1
	35-17	1		13-32	1
	41-20	1		19-206	1
RCR07G474KS	22-174	1		19-206	1
	25-74	1		30-5	1
	25-75	1	RCR07G823KS	29-10	1
	29-1	AR	RCR07G824KS	29-1	AR
RCR07G511JS	23-45	1	RCR07G910JS	17-13	1
	25-3	1		17-15	1
	25-13	1		17-16	1
	25-38	1		17-26	1
	25-40	1		17-60	1
	25-46	1		17-103	1
RCR07G513JS	25-4	1		17-104	1
	25-17	1		17-114	1
RCR07G560KS	19-47	1		17-116	1
	19-212	1		17-118	1
RCR07G562KS	19-206	1	RCR07G913JS	23-23	1
	21-137	1		23-43	1
	21-179	1		23-82	1
	22-41	1		25-24	1
	23-17	1		25-25	1
	25-160	1		25-80	1
RCR07G563KS	21-219	1	RCR20G101KS	27-13	1
	22-122	1		38-50	1
	25-5	1		38-50	1
	25-42	1		39-68	1
RCR07G564KS	29-1	AR	RCR20G102KS	39-69	1
RCR07G680KS	16-140	1		29-16	1
	21-182	1		29-19	1
	21-237	1	RCR20G103KS	24-77	1
	24-17	1	RCR20G120KS	38-4	1
	37-95	1		38-4	1
RCR07G681JS	23-73	1		38-21	1
	25-127	1		38-21	1
RCR07G681KS	22-238	1	RCR20G122KS	24-76	1
RCR07G682KS	18-40	1	RCR20G151KS	38-13	1
	19-143	1		38-14	1
	21-100	1	RCR20G152KS	15-17	1
				15-18	1

NUMERICAL INDEX

PART NUMBER	FIG - ITEM	TTL REQ	PART NUMBER	FIG - ITEM	TTL REQ
	15-23	1		15-8	1
	15-25	1		15-44	1
	15-28	1		15-47	1
	15-34	1		15-48	1
	15-58	1		15-50	1
	15-64	1	RG373K	14-3	1
	15-67	1		14-14	1
	15-75	1	RG81K	11-88	1
RCR20G220KS	2-31	1	RL07S392J	11-104	1
RCR20G222KS	26-5	1	RN50C1000F	11-18	1
RCR20G270KS	27-5	1	RN50C1002F	11-14	1
RCR20G390KS	38-27	1		11-115	1
	38-42	1		11-118	1
RCR20G431JS	17-66	1	RN50C1003F	11-67	1
RCR20G470KS	21-131	1		11-68	1
	22-130	1	RN50C1102F	11-64	1
RCR20G471KS	26-4	1		11-65	1
RCR20G680JS	17-101	1	RN50C1181F	11-69	1
RCR20G680KS	38-50	1		11-70	1
RCR20G820KS	38-5	1	RN50C1272F	11-42	1
	38-12	1	RN50C1502F	11-113	1
	38-25	1	RN50C1541F	11-43	1
	38-34	1	RN50C2261F	11-76	1
	39-108	1	RN50C2672F	11-45	1
	39-112	1		11-46	1
	39-116	1		11-47	1
	39-120	1		11-48	1
	39-124	1	RN50C2741F	11-31	1
	39-127	1		11-32	1
RCR20G910JS	17-67	1	RN50C3161F	11-15	1
RCR32G121KS	24-66	1		11-57	1
RCR32G180KS	40-28	1		11-58	1
RCR32G470KS	39-40	1	RN50C3162F	11-72	1
RC741T	14-73	1		11-74	1
	14-83	1	RN50C4991F	11-114	1
	25-110	1		11-119	1
RE70G1001	40-13	1		11-120	1
RF100K	11-1	1	RN50C5361F	11-128	1
RF101D	31-57	1	RN55D2431F	3-13	1
RF101K	11-2	1	RN55D3481F	3-7	1
	11-86	1		3-26	1
	11-87	1	RN55D5761F	25-39	1
	11-148	1	RN55D6491F	3-6	1
RF3202K	8-10	1		3-7	1
	8-14	1		3-25	1
	9-11	1		3-26	1
	9-13	1	RN55D6811F	3-11	1
RG141K	11-145	1	RN60C5622F	25-56	1
RG178BU	16-154	AR	RN60D6040F	23-67	1
	18-58	AR		25-143	1
	32-116	AR	RN60D6650F	23-76	1
RG191K	11-146	1		25-144	1
RG196AU	19-217	AR	RN65D1960F	31-44	1
	21-254	AR	RN65D2150F	38-28	1
	22-240	AR		38-28A	1
RG3222K	8-6	1		38-29	1
	9-7	1		38-29A	1
RG371K	11-4	1	RN65D46R4F	38-30A	1
RG372K	14-16	1		38-30A	1
	14-51	1		38-30B	1
	15-1	1	RS2R00FR4000F	24-63	1
	15-2	1	RT22C2L103	23-6	1
	15-3	1		25-119	1
			RT22C2L203	33-102	1

NUMERICAL INDEX

PART NUMBER	FIG - ITEM	TTL REQ	PART NUMBER	FIG - ITEM	TTL REQ
	33-103	1		2-26	1
RT22C2L502	23-7	1	SG142	15-7	1
	25-118	1		15-49	1
	33-101	1		15-85	1
RT22C2P101	14-141	1		15-86	1
	21-59	1		15-87	1
	21-232	1	SG143	2-4	1
	22-56	1		2-5	1
	22-223	1		2-9	1
RT22C2P102	14-139	1		2-12	1
RT22C2P103	12-39	1		2-15	1
RT22C2P202	21-208	1		2-21	1
RT22C2P203	22-179	1		2-29	1
RV2NAYS103D	39-61	1		2-51	1
RW67V120	40-26	1		2-96	1
RW67V221	24-26	1		2-98	1
RW67V3R3	29-17	1		2-109	1
RW69V151	23-52	1		2-110	1
	25-36	1		2-122	1
RW70UR237F	24-58	1		8-19	1
	24-59	1		8-25	1
	24-79	1		9-22	1
	29-6	1		9-29	1
RW70U1R00F	29-11	1		13-28	1
	30-12	1		13-31	1
	30-14	1		14-1	1
	11-96	1		14-9	1
RW70U2740F	16-217	4		14-10	1
R22NCFMA1-26	18-64	2		14-67	1
	37-161	4	SG192	15-4	1
	16-7	4		15-5	1
R22NCFMA1-40	30-44	2		15-6	1
	39-134	5		15-88	1
	40-68	8	SG193	2-22	1
R4008X1-8CHROMAT	16-244	2		2-27	1
EDP				2-121	1
	36-55	2		2-127	1
SE23CDPL	16-242	5		5-5	1
	36-56	5		8-23	1
SF103	6-19	1		9-26	1
	14-8	1		14-12	1
SF10303	31-54	1		14-19	1
	31-112	1	SG222	5-13	1
	8-17	1	SG223	6-7	1
	8-27	1		6-36	1
	9-19	1	SG341	11-78	1
	9-31	1		11-83	1
SF202	5-3	1	SG383	2-23	1
SF203	5-6	1		2-103	1
	8-16	1		2-115	1
	9-16	1		2-132	1
	5-12	1	SG41	24-45	1
SF212	5-9	1	SG43	2-126	1
SF213	5-11	1		14-33	1
	5-14	1	SG63	6-48	1
	5-8	1	SG71	11-82	1
SF33	8-8	1	SG8303	12-71	1
	8-30	1		41-7	1
	9-9	1		41-12	1
	9-34	1	SJ5112	1-2	2
SF51	11-85	1	SL157-197	39-10	4
SF53	2-24	1	SL182-197WHT	27-22	14
			SL354-351WHT	3-64	3
				16-246	2

NUMERICAL INDEX

PART NUMBER	FIG - ITEM	TTL REQ	PART NUMBER	FIG - ITEM	TTL REQ
	18-62	24	SN74L02T	6-6	1
	28-16	4		6-29	1
	29-37	24	SN74L04T	9-27	1
	30-43	22		9-43	1
	32-123	50	SN74L10T	6-40	1
	33-112	29		6-47	1
	36-61	2		9-20	1
	37-158	23	SN74L73T	6-6	1
	38-56	29		6-29	1
	38-56	30	SN7400W	6-38	1
	38-56	32		6-50	1
SL439-433WHT	26-75	1	SN7408N	12-67	1
SL441-434WHT	16-245	2	SN74151N	12-77	1
	28-15	9	SN74164N	12-81	1
	29-36	9	SN74197N	12-11	1
	32-122	16	SN7427N	12-10	1
	33-111	26	SN7473N	12-6	1
	36-60	2		12-14	1
	37-136	53		12-34	1
	38-55	2	SN7473W	6-6	1
	38-55	1		6-29	1
	40-32	21	SN7474N	4-11	1
	40-45	7		12-9	1
SL481-491WHT	16-76	6		12-17	1
	16-187	8		31-5	1
	16-210	8		31-52	1
	16-216	9	SP67	22-78	1
	18-63	18		23-84	1
	36-26N	5		25-149	1
SL582-519WHT	16-186	2	SS226	14-4	1
	16-209	1		14-35	1
	16-214	28		14-37	1
SM143	5-25	1		14-40	1
SM153	5-2	1		14-43	1
	8-3	1		14-45	1
	8-13	1		14-49	1
	8-32	1		14-60	1
	8-33	1	SS51149CDPL	39-18A	1
	9-4	1	SS5170	16-213	10
	9-14	1		18-61	12
	9-37	1		32-121	11
	9-39	1		33-110	10
SM63	14-21	1	S060CADPL	1-37	1
	14-26	1		1-37	1
	14-29	1	S29119	32-63	1
	14-30	1		32-70	1
	14-31	1		33-80	1
	14-34	1		33-87	1
	14-36	1	S8266B	12-12	1
	14-38	1		12-79	1
	14-41	1	S8280A	41-36	1
	14-44	1		41-37	1
	14-46	1		41-50	1
	14-50	1	S8281A	41-3	1
SM73	14-24	1	S8415A	12-82	1
SN74H103N	4-1	1	S8424W	14-6	1
	4-4	1	S8816A	41-5	1
	4-20	1	S8822A	41-17	1
	12-7	1		41-56	1
SN74H74N	4-19	1	S8880A	41-1	1
SN74L00T	6-38	1		41-10	1
	6-50	1		41-60	1
	9-18	1	S8890A	41-22	1
	9-25	1	TA2402A	24-41	1
	9-36	1	TC140	26-19	3
	9-46	1			

NUMERICAL INDEX

PART NUMBER	FIG - ITEM	TTL REQ	PART NUMBER	FIG - ITEM	TTL REQ
TC20-110	32-3	AR	T055-13-1K1F	4-37	1
	32-15	AR		4-108	1
	33-33	AR		31-14	1
TC20-81	33-47	AR	31-17	1	
	32-3	AR	T055-14-7K1F	4-53	1
	32-15	AR	4-98	1	
TC20-82	33-33	AR	4-99	1	
	33-47	AR	31-13	1	
	32-3	AR	31-37	1	
TC20-89	32-15	AR	31-38	1	
	33-33	AR	T055-1500-1F	19-111	1
	33-47	AR	T055-1541-1F	4-35	1
TC20-90	32-3	AR	4-55	1	
	32-15	AR	31-12	1	
	33-33	AR	31-16	1	
TC20-92	33-47	AR	T055-1542-1F	4-29	1
	32-3	AR	31-65	1	
	32-15	AR	T055-16-2K1F	14-87	1
TC20-94	33-33	AR	14-151	1	
	33-47	AR	T055-1692-1F	24-29	AR
	32-3	AR	T055-17-8K1F	24-29	AR
TF300	32-15	AR	T055-17400-1F	24-29	AR
	33-33	AR	T055-18200-1F	24-29	AR
	33-47	AR	T055-1872-1F	24-29	AR
T055-1-78K1F	33-47	AR	T055-2-87K1F	16-191	1
	16-74	1	T055-2000-1F	37-25	1
	36-26K	1	14-77	1	
T055-1-96K1F	39-64	3	14-90	1	
	39-66	1	22-171	1	
	40-30	2	22-233	1	
T055-1K1F	21-231	1	22-234	1	
	22-222	1	T055-215K1F	11-27	1
	24-43	1	T055-2210-1F	3-41	1
T055-10K1F	14-143	1	3-55	1	
	14-144	1	T055-26-1K1F	4-38	1
	16-197	1	4-39	1	
T055-100-1F	37-16	1	31-22	1	
	4-56	1	31-23	1	
	4-109	1	T055-27R4-1F	16-202	1
T055-11800-1F	4-110	1	37-26	1	
	14-74	1	T055-29R4F	14-130	AR
	14-84	1	T055-3-16K1F	41-29	1
T055-121K1F	14-142	1	T055-3-83K1F	12-40	1
	14-146	1	12-45	1	
	14-153	1	T055-30R1-1F	14-130	AR
T055-121K1F	31-7	1	T055-30R9F	14-130	AR
	31-96	1	T055-3010-1F	16-173	1
	31-97	1	16-190	1	
T055-100-1F	4-28	1	19-46	1	
	4-88	1	37-27	1	
	4-94	1	T055-301000-1F	11-52	1
T055-100-1F	4-95	1	11-53	1	
	4-96	1	T055-3011-1F	24-24	1
	14-152	1	24-25	1	
T055-100-1F	31-24	1	T055-31-6-1F	14-130	AR
	31-25	1	T055-31-6K1F	25-20	1
	31-34	1	25-49	1	
T055-100-1F	31-35	1	T055-31-6-1F	14-130	AR
	31-64	1	T055-31-6K1F	25-20	1
	21-52	1	25-49	1	
T055-100-1F	22-49	1	T055-32R4F	14-130	AR
	41-25	1	T055-33R2-1F	14-130	AR
			T055-3320-1F	16-163	1
T055-100-1F			T055-332000-1F	12-43	1
			T055-34-8-1F	14-130	AR
			T055-34R0F	14-130	AR
T055-100-1F			T055-35R7F	14-130	AR
			T055-36R5-1F	14-130	AR
			T055-4-64K1F	24-32	AR

NUMERICAL INDEX

PART NUMBER	FIG - ITEM	TTL REQ	PART NUMBER	FIG - ITEM	TTL REQ		
T055-4021-1F	24-44	AR	T055-6490-1F	21-163	1		
	14-89	1		22-12	1		
	14-98	1		4-36	1		
	21-67	1		4-57	1		
	21-73	1		31-11	1		
	21-77	1		31-15	1		
	22-64	1		41-31	1		
	22-70	1		T055-75-1F	22-91	1	
	22-75	1		T055-78R7-1F	21-105	1	
	T055-42-2K1F	12-3		1	22-100	1	
	T055-4421-1F	24-32		AR	22-192	1	
	T055-4530-1F	24-44		AR	T055-8-25K1F	23-112	AR
		24-32		AR	T055-8060-1F	14-75	1
T055-4750-1F	24-44	AR	T055-A6R6-1F	14-88	1		
	24-32	AR		21-35	1		
T055-48R7-1F	24-44	AR	21-75	1			
	14-154	AR	22-25	1			
T055-4871-1F	24-32	AR	22-72	1			
T055-4990-1F	24-44	AR	T055-8661-1F	23-112	AR		
	24-32	AR	T055-9-09K1F	23-112	1		
T055-5-11K1F	24-44	AR	23-112	1			
	4-31	1	25-148	1			
	4-32	1	T055-9531-1F	23-112	AR		
	4-33	1	T1532	27-17	1		
	24-32	AR	32-45	2			
	24-44	AR	33-107	1			
	25-35	1	36-26P	1			
	31-66	1	T1533	16-181	1		
	31-100	1	27-16	2			
	31-101	1	30-36	2			
	32-60	1	32-100	5			
	32-68	1	33-108	6			
	33-88	1	37-155	1			
33-90	1	T1579	16-178	1			
T055-5-62K1F	24-28	1	16-204	1			
	24-32	AR	U3F770931	21-128	1		
	24-44	AR	22-132	1			
	24-69	1	U3F7710312	11-130	1		
T055-51-1-1F	14-154	AR	U3L931251	11-149	1		
T055-5230-1F	24-32	AR	U3M930659X	2-6	1		
T055-53R6-1F	24-44	AR	2-8	1			
	14-154	AR	2-10	1			
T055-5361-1F	24-32	AR	2-13	1			
T055-5490-1F	24-44	AR	2-16	1			
	3-51	1	U4L9327592	2-1	1		
T055-5490-1F	24-32	AR	2-33	1			
	24-44	AR	2-38	1			
T055-56-2-1F	14-154	AR	2-41	1			
T055-5760-1F	24-32	AR	2-44	1			
T055-59R0-1F	24-44	AR	2-46	1			
	14-154	AR	U58770939	4-87	1		
T055-5901-1F	24-32	AR	4-93	1			
T055-61-9-1F	24-44	AR	31-32	1			
	14-154	AR	31-92	1			
T055-619-1F	21-17	1	U587716393	22-85	1		
	21-21	1	23-79	1			
	22-8	1	25-133	1			
	22-79	1	32-40	1			
	39-37	1	USE7754393	21-245	1		
	39-37	1	U5F7715393	4-24	1		
	39-37	1	U5R7723312	3-4	1		
	39-37	1	3-27	1			
	39-37	1	U5R7723393	24-23	1		
	39-37	1	24-35	1			
T055-64R9-1F	14-154	AR	24-72	1			
			4-14	1			

NUMERICAL INDEX

PART NUMBER	FIG - ITEM	TTL REQ	PART NUMBER	FIG - ITEM	TTL REQ
	31-50	1		17-55	1
X8014-1	42-11	1		17-56	1
011-6809	16-215	4		17-58	1
	37-159	4		17-59	1
024-0057-000	1-37	1		17-71	1
054-0368-010	36-18	4		17-72	1
	36-49	13		17-73	1
1N1200R	40-7	1		17-74	1
	40-8	1		17-76	1
1N2818B	24-50	1		17-77	1
1N3070	16-89	1		17-78	1
	16-90	1		17-79	1
	18-50	1		17-81	1
	18-51	1		17-82	1
	37-96	1		17-83	1
	37-97	1		17-84	1
1N4001	14-133	1		17-86	1
1N4003	21-49	1		17-87	1
	22-46	1		17-88	1
	24-37	1		17-89	1
	24-38	1		17-90	1
	24-70	1		17-91	1
	24-71	1		17-93	1
	27-7	1		17-94	1
	27-9	1		38-2	1
	29-15	1		38-3	1
	30-17	1		38-7	1
	40-23	1		38-8	1
	40-24	1		38-8A	1
	40-27	1		38-8A	1
1N4150	11-12	1		38-9	1
	11-13	1		38-10	1
	11-92	1		38-16	1
	11-93	1		38-17	1
1N4454	4-45	1		38-18	1
	4-46	1		38-19	1
	4-47	1		38-23	1
	4-74	1		38-24	1
	31-19	1	1N459	13-2	1
	31-26	1		13-2A	1
	31-27	1		13-3	1
	31-42	1		13-4	1
	31-43	1		13-5	1
	31-79	1		13-6	1
	31-84	1		13-6A	1
1N4562B	24-46	1		13-7	1
1N458	17-32	1		13-8	1
	17-33	1		13-9	1
	17-34	1		13-10	1
	17-35	1		13-11	1
	17-36	1		13-12	1
	17-37	1		13-13	1
	17-39	1		13-14	1
	17-40	1		13-15	1
	17-42	1		13-16	1
	17-43	1		13-16A	1
	17-45	1		13-17	1
	17-46	1		13-18	1
	17-49	1		13-19	1
	17-50	1		13-20	1
	17-52	1		13-21	1
	17-53	1		13-22	1

NUMERICAL INDEX

PART NUMBER	FIG - ITEM	TTL REQ	PART NUMBER	FIG - ITEM	TTL REQ
	13-23	1		20-31	1
	13-26	1		20-32	1
	13-29	1		20-36	1
	13-33	1		20-39	1
	13-34	1		20-40	1
	14-57	1		20-54	1
	14-61	1		21-120	1
	14-62	1		21-142	1
	14-64	1		21-143	1
	14-68	1		21-212	1
	14-69	1		22-135	1
	14-70	1		22-136	1
	14-71	1		22-142	1
	14-72	1		22-206	1
	14-79	1		34-6A	1
	14-80	1		34-23A	1
	14-81	1		34-25	1
	14-95	1		34-26	1
	14-102	1		34-27	1
	14-103	1		34-28	1
	14-104	1		34-29	1
	14-106	1		35-1	1
	14-110	1		35-7B	1
	14-111	1		35-7C	1
	14-112	1		35-31	1
	14-113	1		35-32	1
	14-114	1		35-33	1
	14-115	1		35-35	1
	14-115A	1		36-26D	1
	14-117	1		36-26G	1
	14-119	1		40-40	1
	14-120	1		40-41	1
	14-121	1	1N4649	11-62	1
	14-122	1	1N4656	11-95	1
	14-123	1	1N4733	22-158	1
	14-124	1		23-57	1
	14-125	1		25-34	1
	14-126	1	1N4741	23-27	1
	14-158	1		25-100	1
	14-159	1	1N5198	40-22	1
	14-162	1		40-25	1
	14-164	1	1N5550	40-22	1
	14-167	1		40-25	1
	14-169	1	1N5767	16-91	1
	14-170	1		16-102	1
	14-171	1		16-106	1
	16-65	1		16-115	1
	16-69	1		16-138	1
	18-35	1		16-167	1
	18-36	1		18-49	1
	19-22	1		21-25	1
	19-23	1		21-32	1
	19-59	1		21-139	1
	19-60	1		21-150	1
	19-125	1		22-16	1
	19-134	1		22-22	1
	19-139	1		22-29	1
	19-140	1		22-43	1
	19-142	1		37-2	1
	19-183	1		37-3	1
	19-213	1		37-40	1
	20-24	1		37-42	1
	20-26	1		37-85	1



NUMERICAL INDEX

PART NUMBER	FIG - ITEM	TTL REQ	PART NUMBER	FIG - ITEM	TTL REQ	
1N645	37-120	1		32-32	1	
	12-29	1		32-33	1	
	14-138	1		32-73	1	
	1N746A	11-63	1		33-7	1
		15-19	1		33-51	1
		15-33	1		33-52	1
		15-53	1		33-61	1
		15-59	1		33-66	1
		15-62	1		41-23	1
		15-74	1		41-61	1
	16-159	1	1N963B	4-117	1	
	21-70	1		11-98	1	
	22-67	1		31-69	1	
1N750A	11-134	1	1N971B	12-22	1	
	11-136	1		12-22	1	
	24-81	1	1P4-26A	28-17	2	
1N751	27-11	1	10-70506-16	26-9	2	
	4-60	1	10-70506-18	26-10	1	
	4-62	1	10BRZ	40-69	1	
	31-45	1	100-200-7-0	24-82	3	
	31-105	1	102SR1H2JH1	39-8	1	
1N751A	31-106	1	102203R	39-6	1	
	21-118	1	109N1A7X0010F2	12-65	1	
1N753A	22-113	1	11J1043	39-70	1	
	21-216	1	1220-02	39-25	2	
	22-126	1		39-63	5	
1N914	24-9	1	1251-003	39-63	4	
	24-74	1		32-10	1	
	2-66	1		32-20	1	
	2-128	1		32-23	1	
	12-1	1		32-25	1	
	12-2	1		32-27	1	
	12-41	1		32-28	1	
	12-42	1		33-65	1	
	12-44	1		33-67	1	
	12-48	1		33-68	1	
12-59	1		33-70	1		
21-119	1		33-71	1		
21-204	1		33-75	1		
22-114	1		12914A	16-185	4	
22-202	1			16-208	4	
23-54	1		13590	26-12	1	
23-59	1		140-0530-1003	26-63	5	
23-62	1		140-0530-1004	26-62	5	
23-63	1		140-0530-1005	26-67	3	
24-6	1		140-0530-1006	26-65	1	
24-16	1		140-0530-1007	26-64	2	
24-53	1		140-0530-1009	26-66	1	
24-61	1		140-0530-4018	26-69	1	
25-15	1		140-0530-4019	26-68	2	
25-60	1		140-0530-9013	6-61	1	
25-61	1		140-0530-9014	16-153	3	
25-71	1			16-153		
25-122	1			16-153		
25-141	1			18-59	1	
25-142	1			37-31	1	
28-4	1			37-32	1	
28-5	1			37-50	1	
28-10	1		141-1002-0002	16-62	1	
28-11	1			19-218	1	
32-19	1			19-219	1	
32-24	1			19-220	1	

NUMERICAL INDEX

PART NUMBER	FIG - ITEM	TTL REQ	PART NUMBER	FIG - ITEM	TTL REQ
	21-248	1		31-89	1
	21-249	1	1537-48	19-118	1
	21-250	1	28218	19-135	1
	21-251	1	28252	20-35	1
	22-241	1	28253	20-1	1
	22-242	1	28261	20-35	1
	22-243	1	28263	20-23	1
	32-117	1	28272	20-1	1
	32-118	1	28293	20-1	1
	33-104	1	28298	19-135	1
	33-105	1	2C067102X0101A3	16-155	1
	36-24	1		16-192	1
141-1002-0003	3-56	1		18-16	1
	3-58	1		37-20	1
	5-26	1		37-66	1
	6-55	1		37-83	1
	6-56	1		37-86	1
	6-57	1		37-107	1
	6-58	1		37-127	1
	6-59	1		37-135	1
	8-51	1		39-14	1
	8-52	1		39-15	1
	9-58	1	2C067103X0101A3	15-15	1
	9-59	1		15-16	1
14464	26-11	1		15-22	1
150D105X0035A2	21-92	1		15-26	1
	21-117	1		15-29	1
	22-143	1		15-35	1
150D105X9035A2	2-50	1		15-57	1
	41-34	1		15-65	1
150D106X9020B2	2-25	1		15-68	1
	2-37	1		15-76	1
	2-73	1		16-93	1
150D156X9020B2	21-117	1		16-130	1
150D225X0020A2	18-24	1		18-9	1
150D226X9035R2	30-23	1		18-22	1
	30-26	1		18-25	1
	30-31	1		18-37	1
150D474X9035A2	30-3	1		18-41	1
150D475X0035B2	22-215	1		18-44	1
	23-16	1		19-9	1
	23-46	1		19-12	1
	23-81	1		19-15	1
	23-99	1		19-17	1
	25-2	1		19-30	1
	25-19	1		19-37	1
	25-57	1		19-41	1
	25-78	1		19-48	1
	25-104	1		19-52	1
	25-108	1		19-62	1
	25-128	1		19-63	1
	25-130	1		19-73	1
	25-165	1		19-76	1
	25-166	1		19-80	1
	29-2	1		19-84	1
	29-3	1		19-86	1
150D476X0020R2	23-3	1		19-88	1
	23-111	1		19-90	1
	25-37	1		19-96	1
	25-139	1		19-97	1
151D115X9020W2	11-51	1		19-107	1
	31-28	1			

NUMERICAL INDEX

PART NUMBER	FIG - ITEM	TTL REQ	PART NUMBER	FIG - ITEM	TTL REQ
	19-110	1		22-45	1
	19-115	1		22-63	1
	19-116	1		22-74	1
	19-123	1		22-95	1
	19-126	1		22-96	1
	19-127	1		22-119	1
	19-132	1		22-177	1
	19-133	1		22-199	1
	19-136	1		22-218	1
	19-138	1		22-239	1
	19-149	1		23-18	1
	19-160	1		23-19	1
	19-161	1		23-47	1
	19-163	1		23-77	1
	19-166	1		23-109	1
	19-168	1		24-31	1
	19-171	1		24-34	1
	19-174	1		24-75	1
	19-178	1		25-8	1
	19-181	1		25-9	1
	19-185	1		25-33	1
	19-192	1		25-47	1
	19-194	1		25-51	1
	19-197	1		25-52	1
	19-201	1		25-54	1
	19-211	1		25-125	1
	19-215	1		25-132	1
	19-216	1		25-154	1
	20-3	1		25-169	1
	20-4	1		33-16	1
	20-7	1		33-17	1
	20-11	1		33-34	1
	20-15	1		33-44	1
	20-21	1		33-48	1
	20-25	1		33-49	1
	20-28	1		33-63	1
	20-29	1		33-78	1
	20-30	1		33-81	1
	20-34	1		33-85	1
	20-37	1		33-89	1
	20-41	1		34-17	1
	20-42	1		34-20	1
	20-51	1		34-23	1
	20-53	1		35-19	1
	20-61	1		35-22	1
	20-63	1		35-26	1
	21-4	1		37-41	1
	21-10	1		37-58	1
	21-41	1		37-64	1
	21-42	1		37-93	1
	21-50	1		37-106	1
	21-66	1		37-115	1
	21-72	1		37-122	1
	21-76	1		37-128	1
	21-79	1		37-129	1
	21-125	1		38-33	1
	21-172	1		38-39	1
	21-199	1		38-44	1
	21-226	1		38-46	1
	22-3	1		38-48	1
	22-21	1		38-51	1
	22-32	1		38-52	1
	22-33	1	2C067104X0101A3	15-36	1

NUMERICAL INDEX

PART NUMBER	FIG - ITEM	TTL REQ	PART NUMBER	FIG - ITEM	TTL REQ
	15-63	1		29-22	1
	16-67	1	2N1671	2-69	1
	16-88	1	2N1711	27-2	1
	16-95	1	2N2222	2-32	1
	16-110	1		2-62	1
	16-111	1		2-80	1
	16-134	1		2-111	1
	18-4	1	2N2222A	4-64	1
	18-5	1		4-113	1
	18-38	1		12-25	1
	18-46	1		12-33	1
	27-4	1		12-46	1
	28-8	1		12-47	1
	28-9	1		12-86	1
	28-13	1		13-25	1
	32-31	1		14-11	1
	32-34	1		14-76	1
	32-50	1		14-78	1
	32-71	1		14-85	1
	32-82	1		14-96	1
	32-87	1		14-97	1
	32-98	1		14-129	1
	36-26F	1		14-131	1
2C067182X0101A3	29-9	1		14-132	1
2C067223X0101A3	22-178	1		15-11	1
	25-16	1		15-40	1
2C067332X0101A3	21-7	1		15-43	1
	21-171	1		15-83	1
	21-177	1		16-71	1
	21-246	1		16-180	1
	22-182	1		19-4	1
	22-232	1		19-8	1
2C067472X0101A	23-107	1		19-54	1
2C067472X0101A3	21-24	1		20-48	1
	21-27	1		20-56	1
	21-31	1		21-5	1
	21-34	1		21-13	1
	21-36	1		21-18	1
	21-56	1		21-22	1
	21-62	1		21-29	1
	21-110	1		21-47	1
	21-189	1		21-109	1
	22-15	1		21-113	1
	22-18	1		21-113	1
	22-24	1		21-133	1
	22-27	1		21-151	1
	22-50	1		21-187	1
	22-60	1		21-190	1
	22-105	1		21-213	1
	22-148	1		21-220	1
	22-236	1		21-228	1
	23-41	1		22-10	1
	25-123	1		22-13	1
	25-153	1		22-19	1
2C067473X0101A3	21-145	1		22-26	1
	21-215	1		22-47	1
	22-138	1		22-104	1
	22-207	1		22-109	1
	23-22	1		22-111	1
	23-104	1		22-129	1
	25-103	1		22-165	1
	25-109	1		22-191	1

## NUMERICAL INDEX

PART NUMBER	FIG - ITEM	TTL REQ	PART NUMBER	FIG - ITEM	TTL REQ
	22-210	1	2N2905	21-113	1
	22-211	1		21-132	1
	23-4	1		22-128	1
	23-14	1	2N2907	4-76	1
	23-21	1		20-12	1
	23-25	1		20-45	1
	23-31	1		20-60	1
	23-38	1	2N2907A	4-23	1
	23-44	1		4-116	1
	23-49	1		15-14	1
	23-60	1		15-21	1
	23-66	1		15-27	1
	23-70	1		15-37	1
	23-88	1		15-66	1
	23-94	1		15-70	1
	23-95	1		15-77	1
	24-11	1		15-78	1
	24-12	1		19-14	1
	24-18	1		19-16	1
	24-57	1		19-34	1
	25-21	1		19-40	1
	25-22	1		19-57	1
	25-29	1		19-109	1
	25-31	1		19-121	1
	25-66	1		21-121	1
	25-67	1		22-115	1
	25-82	1		25-10	1
	25-83	1		25-111	1
	25-87	1		27-15	1
	25-91	1		30-35	1
	25-94	1		31-62	1
	25-95	1		31-70	1
	25-150	1		34-8	1
	25-151	1		34-11	1
	25-152	1		34-14	1
	25-155	1		35-10	1
	25-157	1		35-13	1
	27-14	1		35-16	1
	30-34	1	2N3054	29-7	1
	31-67	1		30-37	1
	31-107	1		30-38	1
	32-77	1	2N3135	15-14	1
	32-93	1		15-21	1
	32-99	1		15-27	1
	33-2	1		15-30	1
	33-12	1		15-37	1
	33-13	1		15-56	1
	33-54	1		15-66	1
	34-3	1		15-70	1
	35-4	1		15-77	1
	36-26H	1		15-78	1
	37-87	1	2N3486A	11-103	1
	41-19	1	2N3716	40-5	1
2N2369A	41-30	1		40-6	1
	2-34	1	2N3740	27-18	1
	2-55	1		29-12	1
	2-113	1		30-40	1
2N2432	4-34	1	2N3741	24-40	1
	4-59	1		40-9	1
	31-99	1	2N3766	30-37	1
	31-102	1		30-38	1
2N2608	23-12	1	2N4045	11-37	1
	25-178	1	2N4416	19-68	1

NUMERICAL INDEX

PART NUMBER	FIG - ITEM	TTL REQ	PART NUMBER	FIG - ITEM	TTL REQ
	19-87	1	2465-008W5T0102P	37-110	1
	19-92	1		37-136	1
	19-93	1	2465-009W5T0102P	16-31	1
	19-150	1		16-32	1
	19-152	1		16-33	1
	19-167	1		16-34	1
	19-172	1		16-35	1
	19-180	1		16-36	1
	19-198	1		16-37	1
2N4416A	19-128	1		16-38	1
	19-203	1		16-39	1
2N4855	11-106	1		16-40	1
	11-112	1		16-41	1
2N5066	11-121	1		16-42	1
	11-122	1		16-43	1
2N5109	16-177	1		16-44	1
	16-203	1		16-45	1
	18-33	1		16-46	1
	18-33	1		16-47	1
	37-23	1		16-48	1
	37-52	1		16-49	1
	37-75	1		16-50	1
2N6027	41-24	1		16-51	1
2Q1	16-86	1		16-52	1
	37-51	1		16-53	1
20049	40-2	1		16-54	1
205	39-63	1		16-230	1
2104-04-01-2520N	26-78	1		16-231	1
	38-30	1		16-232	1
	38-43	1		16-233	1
	38-53A	1		16-234	1
	39-16	1		16-235	1
	39-20	1		36-12	1
	39-136	1		36-13	1
	40-53	1		36-13A	1
2115	40-8	2		36-16	1
21801MPORMSPCT	6-3	1		36-17	1
220-1283-020	39-131	6		36-17A	1
23TD21	16-109	1		36-33	1
	37-125	1		36-34	1
240-2711-170	16-158	1		36-35	1
	16-176	1		36-36	1
	16-194	1		36-37	1
	37-18	1		36-38	1
240-2711-300	3-23	1		36-39	1
	5-16	1		36-40	1
	5-17	1		36-41	1
	5-18	1		36-42	1
	6-41	1		36-42A	1
	16-92	1		36-42B	1
	16-94	1		36-46	1
	16-117	1		36-47	1
	16-118	1		36-48	1
	16-123	1		36-48A	1
	16-141	1		36-48B	1
	37-28	1	2482-010W5T102AA	16-119	1
	37-62	1		16-120	1
	37-63	1		16-121	1
	37-94	1		16-143	1
	37-104	1		16-144	1
	37-109	1		16-145	1
	37-123	1		16-146	1

NUMERICAL INDEX

PART NUMBER	FIG - ITEM	TTL REQ	PART NUMBER	FIG - ITEM	TTL REQ
	16-182	1	280103K1	39-63	1
	16-206	1	289-7179-010M70	32-115	1
2504-04-00-2220N	29-7	1		33-72	1
	30-39	3	289-7179-020M70	33-72	1
	40-6	2	2890-30	29-18	1
	40-9	1	293-1252-020	20-35	1
262C025151X5101B	6-8	1	293-1266-020	20-35	1
	6-9	1	3N141	21-94	1
262C067103X0101B	8-2	1		22-229	1
	9-3	1	3PP4-66A	16-184	1
262C067222X0101B	5-1	1	3SAV1118A2	14-136	1
	5-4	1	3SAV1119A2	24-56	1
	5-7	1		24-64	1
	5-10	1	3SAV1556A2	16-72	1
	5-15	1		36-26J	1
	5-21	1	3SBC1380A2	32-111	1
	5-24	1		32-112	1
	6-12	1	302-0646-050	27-18	2
	6-16	1		29-7	2
	6-24	1		30-39	4
	6-27	1		30-40	4
	6-54	1		40-6	4
	8-9	1		40-9	2
	8-11	1	302-4800-000	26-70	1
	8-12	1		32-118	2
	8-15	1		33-105	2
	8-18	1	303-1000-000	6-60	1
	8-21	1	31-759	40-62	4
	8-22	1	310-0045-000	1-38	3
	8-24	1		20-1	2
	8-26	1		20-23	2
	8-31	1		20-35	2
	8-34	1		27-18	2
	8-36	1		40-11	8
	8-39	1		42-8	4
	8-42	1	310-0046-000	29-7	4
	8-44	1		42-11	3
	8-47	1	310-0054-000	26-1	2
	8-49	1		26-3	2
	9-10	1		26-78	7
	9-12	1		30-39	4
	9-15	1		40-6	4
	9-17	1		40-9	2
	9-21	1	310-0055-000	40-35	4
	9-24	1	310-0057-000	33-99	4
	9-28	1	310-0061-000	39-8	1
	9-30	1		39-63	1
	9-35	1	310-0070-000	33-100	2
	9-38	1		37-35	1
	9-40	1		39-2	4
	9-42	1	310-0075-000	16-83	4
	9-49	1		29-28	2
	9-50	1		29-34	3
	9-51	1		30-41	6
	9-55	1		39-28	2
	9-57	1	310-0078-000	40-10	1
263C025681X5101B	25-41	1		40-52	1
276805CK3	39-59	1	310-0129-000	37-34	2
278-0349-020	37-34	1		37-49	2
278-0401-020	37-35	1	310-0278-000	16-17	18
278-0404-010	18-23	1		20-1	2
	18-27	1		20-23	2
280100K2	39-62	1			

NUMERICAL INDEX

PART NUMBER	FIG - ITEM	TTL REQ	PART NUMBER	FIG - ITEM	TTL REQ
	20-35	2		14-173	44
	26-1	2		15-90	44
	26-78	8		19-225	11
	33-99	4		21-256	15
	39-23	2		22-247	14
	40-51	2		23-116	21
310-0447-000	42-8	4		24-84	24
310-6320-000	6-42	4		25-182	21
	16-60	2		31-116	24
	25-1	6		34-31	15
	36-3	2		35-37	32
	36-8	2		41-66	30
	36-11	2	372-2234-020	2-136	42
	36-27	2		4-120	23
	36-31	2		11-153	23
	39-28	2		12-94	23
310-6340-000	20-1	2		13-37	32
	20-23	2		14-174	44
	20-35	2		15-91	30
310-6360-000	42-2	1		19-226	10
	42-5	1		21-257	14
310-6380-000	26-12	4		22-248	12
3292L1-203	32-108	1		23-115	21
	32-109	1		24-85	23
3292L1-502	32-110	1		25-183	24
330-1701-050	37-151	2		31-117	23
3329H1-502	16-142	1		34-30	20
	37-9	1		35-36	25
	37-45	1	372-2252-010	41-65	23
350-3072-020	16-87	1		19-227	31
	18-15	1	372-2255-020	16-57	11
350-3080-020	37-8	1		16-222	3
3501FP	40-58	1		36-5A	3
352-0756-011	20-6	1		36-28	11
	20-18	1	372-2601-010	17-119	28
352-0766-011	18-33	1		19-224	2
352-7500-451	3-40	1		26-80	20
	3-42	1	372-2601-026	23-114	6
	3-50	1	372-2601-027	13-37A	1
	3-53	1	372-2601-033	6-64	2
352-9577-030	3-28	3	372-2601-037	4-119	10
352-9577-040	3-54	4		11-151	4
352-9615-010	27-18	1		12-91	9
353-3338-001	3-44	1		14-172A	2
	3-52	1		20-66	31
36C175A	40-14	1		21-255	23
	40-19	1		22-246	6
	40-20	1		31-115	10
	40-21	1		41-64	33
36D303G015CC2A	26-7	1	372-2601-150	26-79	551
36D902G050BC2A	26-8	1	372-2601-168	3-63	1
372-2234-010	2-135	43	372-2621-011	11-155	1
	3-61	9	372-2621-012	23-117	1
	4-121	24	372-2621-014	34-32	1
	5-29	36		35-38	1
	6-65	20	372-2621-015	5-32	1
	8-55	63		41-67	1
	9-62	63	372-2621-016	5-31	1
	11-152	26		6-67	1
	12-93	24	372-2621-018	3-62	1
	13-36	21	372-2621-019	8-57	1
				9-64	1
			372-2621-020	5-30	1
			372-2621-021	5-33	1



NUMERICAL INDEX

PART NUMBER	FIG - ITEM	TTL REQ	PART NUMBER	FIG - ITEM	TTL REQ
372-2621-022	6-66	1		36-26A	1
372-2621-023	15-93	1		40-29	3
372-2621-026	8-56	1	4040-2HT	40-38	1
	9-63	1		29-34	1
372-2621-027	8-58	1		37-33	1
	8-59	1		37-49	1
	9-65	1		37-152	1
	9-66	1	4040-5HDSPL	39-23	2
372-2623-012	25-184	1		39-136	1
372-2623-013	21-259	1		40-51	1
	22-250	1	41C157	40-49	1
372-2623-020	19-228	1		40-50	1
	21-258	1	410MY2	40-64	1
372-2623-022	22-249	1	410MY6	40-63	1
372-2623-031	13-38	2	42TF29	21-129	1
	14-175	1		22-127	1
372-2623-033	4-122	1	422-04-22-034-11	42-10	1
	11-154	1	3		
	12-95	1	425-1494-000	39-21	AR
	31-118	1	43-03-2	40-6	2
372-2623-037	41-68	1	43-66-1	27-18	1
	23-118	1		29-7	1
	25-185	1		30-39	2
372-2623-048	24-86	1		30-40	2
372-2623-052	2-137	1	458-0840-010	40-9	1
	15-92	1	4704-04-01-4102	39-1	1
	34-33	1		24-41	2
	35-39	1		24-47	2
372-2624-014	19-231	1		24-51	2
372-2624-016	19-229	1	4720-54-1	40-17	1
372-2625-016	19-230	1	5082-8907	16-156	1
38422SMLR	39-33	1		37-68	1
38423SMLR	39-30	1	5133-18C	26-20	41
38424SMLR	39-34	1	522-4836-004	1-	1
38425SMLR	39-31	1	522-4836-102	1-	1
	39-32	1	522-4836-103	1-	1
39352-48LR1	39-24	1	522-4836-104	1-	1
	39-25	1	522-4836-106	1-	1
4-11633	3-37	1	522-4836-107	1-	1
4-11634	3-17	1	522-4836-108	1-	1
4005	16-179	1	522-4836-110	1-	1
	16-205	1	522-4836-111	1-	1
	37-76	3	522-4836-113	1-	1
4007-4HT	16-56	1	522-4836-120	1-	1
	16-219	1	522-4836-121	1-	1
	27-18	1	522-4836-122	1-	1
	27-20	1	522-4836-123	1-	1
	29-12	2	522-4836-124	1-	1
	29-33	2	522-4836-125	1-	1
	30-39	3	522-4836-126	1-	1
	36-5	1	522-4836-128	1-	1
	36-32	1	522-4836-129	1-	1
	38-30	2	522-4836-131	1-	1
	39-66	1	522-4836-132	1-	1
4007-6HT	24-41	1	522-4836-133	1-	1
	24-47	1	522-4836-134	1-	1
	24-51	1	522-4836-135	1-	1
4019-4	29-28	2	522-4836-152	1-	1
4021	26-6	8	522-4836-153	1-	1
	26-12	1	522-4836-154	1-	1
403	39-65	1	522-4836-156	1-	1
4040-2HDSPL	16-64	1	522-4836-173	1-	1
			522-4836-179	1-	1

NUMERICAL INDEX

PART NUMBER	FIG - ITEM	TTL REQ	PART NUMBER	FIG - ITEM	TTL REQ
522-4836-180	1-	1		39-46	1
522-4836-181	1-	1		39-47	1
522-4836-182	1-	1		39-48	1
522-4836-183	1-	1		39-49	1
522-4836-184	1-	1		39-50	1
526-9634-010	19-186	1		39-51	1
	19-186	1		39-52	1
	19-186	1		39-53	1
526-9634-050	19-186	1		39-54	1
	19-186	1	55D49R9F	14-154	AR
526-9643-010	19-187	1	55D4990F	14-145	1
526-9652-010	19-77	1	55D52R3F	14-154	AR
	19-77	1	55D54R9F	14-154	AR
	19-77	1	55D57R6F	14-154	AR
526-9652-050	19-77	1	55D60R4F	14-154	AR
526-9678-010	19-186	1	55D63R4F	14-154	AR
526-9679-010	19-77	1	55D80R6F	39-38	1
526-9733-020	19-186	1		39-38	1
	19-186	1	55D80A0F	21-168	1
526-9734-020	19-77	1		22-161	1
	19-77	1		39-38	1
	19-77	1		39-38	1
538002C0P089R	16-84	1	5555-18MD	1-34	1
	16-85	1	5610-6-16	23-5	2
	37-12	1	600D187G050DX5	24-20	1
	37-14	1		24-21	1
540-9002-003	40-36	2		24-22	1
540-9003-003	39-71	2	600D227G020NG5	29-21	1
540-9038-003	39-36	6	600D507G020DL5	30-21	1
540-9059-003	39-17	4		30-22	1
541-5953-002	40-38	2	601D108G050JL6	40-12	1
546-6126-002	16-244	1	606-0545-010	1-38	1
	36-55	1	606-9029-002	39-29	5
546-6127-002	16-243	1	606-9395-001	39-139	1
	36-54	1	606-9401-001	39-135	1
547-5305-002	40-52	2	606-9403-001	39-4	2
	40-53	1	606-9404-001	1-34	1
547-8177-003	24-47	2	606-9405-001	1-35	1
	24-51	2	606-9406-001	1-33	1
	30-39	4	606-9408-001	39-11	1
547-8177-006	24-41	2	606-9410-001	39-81	1
55D1820F	16-193	1	606-9412-002	39-136	2
	37-126	1	606-9414-001	39-72	2
55D2000F	22-94	1	606-9416-001	39-140	1
55D2100F	39-41	1	606-9422-002	1-1	1
55D22R1F	16-169	1	606-9423-003	1-40	1
55D2210F	39-42	1		26-	RF
55D2670F	18-39	1	606-9423-005	1-40	1
	21-40	1		26-	RF
	21-154	1	606-9423-006	1-40	1
	21-156	1		26-	RF
	22-58	1	606-9423-007	1-40	1
	22-145	1		26-	RF
	22-149	1	606-9423-009	1-40	1
55D32R4F	21-63	1		26-	RF
	22-59	1	606-9424-002	26-14	1
55D34R0F	14-130	1		40-	RF
55D45R3F	21-193	1	606-9424-004	26-14	1
	22-192	1		40-	RF
55D47R5F	14-154	AR	606-9424-005	26-14	1
	39-43	1		40-	RF
	39-44	1	606-9424-006	26-14	1
	39-45	1			

NUMERICAL INDEX

PART NUMBER	FIG - ITEM	TTL REQ	PART NUMBER	FIG - ITEM	TTL REQ
606-9425-003	40-	RF	608-9087-001	1-17	1
	26-13	1		34-	RF
	39-	RF	608-9121-001	1-17	1
606-9425-004	26-13	1		35-	RF
	39-	RF	608-9158-001	34-34	1
606-9425-005	26-13	1		35-40	1
	39-	RF	608-9278-001	19-70	1
606-9426-002	26-15	1		19-70	1
606-9428-001	39-67	1		19-193	1
606-9431-001	29-38	1		19-193	1
606-9432-001	1-39	2	609-0185-001	32-107	1
606-9437-001	40-17	1	609-0303-001	42-17	1
606-9440-001	19-27	1	609-0306-001	40-11	1
606-9441-001	40-47	1	609-0307-001	42-2	1
606-9444-001	40-35	1	609-0307-002	42-5	1
606-9446-002	39-141	1	609-0307-003	42-3	1
606-9447-001	39-74	1		42-6	1
606-9448-001	39-77	1	609-0307-004	42-4	1
606-9701-001	40-33	1		42-7	1
606-9705-001	39-5	1	609-0494-001	1-3	1
606-9705-002	39-5	1	609-0494-002	1-4	2
606-9706-002	39-28	1	609-0494-003	40-1	1
606-9707-002	39-73	1	609-0495-001	1-5	2
606-9708-001	26-16	1	609-0496-001	40-4	1
	29-	RF	609-0505-001	39-137	2
606-9710-003	39-36	1	609-0506-001	1-41	1
606-9710-004	39-36	1	609-0507-001	1-41	1
606-9713-001	28-2	1	609-0541-001	40-71	1
	28-3	1	609-0543-001	1-6	1
606-9714-004	1-38	1	609-0544-001	32-124	1
	1-38	1	609-0545-008	1-38	1
606-9714-005	1-38	3	609-0545-011	1-38	1
	1-38	1	609-0545-013	1-38	1
606-9714-006	1-38	1	609-0547-001	1-36	1
606-9714-007	1-38	3	609-0548-001	32-2	1
606-9714-008	1-38	1	609-0549-001	40-38	1
606-9714-014	1-38	1	609-0549-002	40-38	1
606-9715-001	28-18	1	609-0550-001	40-18	1
606-9716-001	28-1	1	609-0551-001	32-119	1
606-9717-001	39-9	1	609-0551-002	32-119	1
606-9719-001	39-79	2	609-0552-001	25-1	1
606-9720-001	39-13	1		32-	RF
606-9721-001	39-132	1	609-0552-002	23-1	1
606-9723-001	40-31	1		25-1	1
606-9724-001	40-44	1		32-	RF
606-9725-001	26-81	1	609-0553-002	39-17	1
606-9867-001	1-7	1	609-0553-003	39-17	1
606-9868-001	1-8	1	609-0553-004	39-17	1
606-9870-002	40-65	1	609-0554-001	39-3	1
606-9877-002	16-83	1	609-0557-001	42-13	1
606-9879-002	16-226	1	609-0560-001	42-14	1
	36-11	1	609-0561-001	42-8	1
606-9879-003	16-226	1	609-0565-001	39-2	2
606-9879-004	36-11	1	609-0566-001	39-138	2
606-9879-005	36-11	1	609-0784-002	6-42	1
606-9880-002	16-2	1	609-0792-001	26-21	1
606-9880-003	16-2	1		26-22	1
606-9884-001	28-	RF		26-23	1
	40-37	1		26-24	1
606-9885-001	28-14	1		26-25	1
606-9886-001	29-35	1		26-26	1
607-7721-001	3-47	1		26-27	1
607-7722-001	3-46	1		26-28	1

NUMERICAL INDEX

PART NUMBER	FIG - ITEM	TTL REQ	PART NUMBER	FIG - ITEM	TTL REQ
	26-29	1	609-1560-001	16-236	1
	26-30	1		36-19	1
	26-31	1	609-1561-001	16-55	1
	26-32	1		36-50	1
	26-33	1	609-1562-001	16-212	1
	26-34	1	609-1565-001	1-41	1
	26-35	1	609-1566-001	16-77	1
	26-36	1		36-260	1
	26-37	1	609-1567-001	32-124	1
	26-38	1	609-1568-001	18-66	1
	26-39	1	609-1569-001	32-2	1
	26-40	1	609-1570-001	36-52B	2
	26-41	1	609-1570-002	16-238	4
	26-42	1		36-52A	2
	26-43	1	609-1609-001	26-1	1
	26-44	1	609-1631-001	16-241	1
	26-45	1		36-53	1
	26-46	1	609-1632-001	16-79	1
	26-47	1		36-19A	1
	26-48	1	609-1633-001	16-A0	1
	26-49	1		36-1	1
	26-50	1	609-1634-001	16-A	1
	26-51	1	609-1635-001	16-1	1
	26-52	1		36-21	1
	26-53	1	609-1636-001	16-5	4
	26-54	1	609-1638-001	16-6	2
	26-55	1		16-6	1
	26-56	1		16-250	18
	26-57	1		18-65	2
	26-58	1		36-62	21
	26-59	1		38-59	2
	26-60	1	609-1640-001	16-4	1
	26-61	1		16-4	1
609-0919-001	39-12	5	609-1641-001	18-60	1
609-0920-001	42-12	1	609-1642-001	16-75	1
609-0925-001	20-65	1		36-26M	1
609-0925-002	20-65	1	609-1643-001	16-82	1
609-0925-010	20-65	1		18-	RF
609-0925-011	20-65	1		36-19R	1
609-0925-012	20-65	1	609-1644-001	16-64	1
609-0926-001	27-23	1		36-26A	1
609-0927-001	27-21	1	609-1645-001	26-71	1
609-0928-001	27-	RF	609-1646-001	26-76	1
	39-22	1	609-1647-001	26-74	1
609-0931-001	39-130	7	609-1648-001	26-70	1
609-0932-001	39-35	1	609-1649-001	26-73	1
609-0938-001	16-211	1	609-1650-001	26-72	2
609-0944-001	1-43	1	609-1651-001	18-1	1
609-0945-001	16-188	1	609-1652-001	16-207	1
609-1544-001	16-247	2	609-1653-001	16-183	1
	36-57	2	609-2541-001	14-	1
609-1545-001	16-248	3	609-2792-001	23-111	1
	36-59	3	609-9440-001	19-177	1
609-1545-002	16-249	5	609-9445-001	26-77	1
	36-58	5	61PNR2K	18-31	1
609-1546-001	16-251	1	61PNR500	37-7	1
	36-63	1		37-13	1
609-1548-001	18-19	1		5-18R	1
609-1554-001	1-44	1	610-1957-004	5-18A	1
609-1557-001	18-1	1	610-2150-001	39-17	1
609-1558-001	32-120	10	618-3253-001	37-151	1
	33-109	10	618-3253-002	37-150	1
			618-3254-001	37-149	1
			618-3255-001	37-147	1
			618-3256-001	37-162	1

NUMERICAL INDEX

PART NUMBER	FIG - ITEM	TTL REQ	PART NUMBER	FIG - ITEM	TTL REQ
618-3257-001	37-154	1	68NM40	39-20	12
618-3258-001	36-3	1		39-20	8
	37-	RF		40-13	2
618-3260-001	36-27	1	68NM62	40-2	4
618-3260-002	36-27	1	754	31-9	1
618-3339-001	1-41		756-7045-002	23-5	1
	1-41	1		25-117	1
618-3407-001	37-153	1	766-7354-002	6-60	1
618-6623-001	26-20	41	7717-114N	2-70	1
618-7103-001	30-45	1		25-134	4
618-7104-001	30-42	1		25-134	4
618-7105-001	26-16	1	7717-130DAP	2-114	8
	30-	RF		11-140	5
618-7677-001	38-54	1		15-84	14
618-7677-002	38-60	1	772-4689-001	32-106	1
618-7678-001	36-23	1	774-7842-001	1-15	1
	38-	RF		4-	RF
618-7678-002	36-23	1	774-7845-001	4-123	1
	38-	RF	778-2924-004	1-16	1
618-7702-001	33-113	1		13-	RF
618-7703-001	33-1	1	778-2924-006	1-16	1
618-7704-001	33-106	1		13-	RF
618-7705-001	23-1	1	778-2924-007	1-16	1
	25-1	1		13-	RF
	33-	RF	778-2928-003	1-17	1
618-7705-002	23-1	1		15-	RF
	33-	RF	778-2934-002	16-3	1
62	39-76	1		17-	RF
	39-78	1	778-2934-003	16-3	1
622-1062-001	1-	1		17-	RF
624-3524-001	6-3	1	778-2940-002	15-89	1
	6-34	1	778-2948-002	1-23	1
624-5744-001	1-16	1		25-	RF
	14-	RF	778-2948-003	1-23	1
624-5746-001	14-172	1		23-	RF
624-5781-001	1-15	1	778-2948-004	1-23	1
	31-	RF		25-	RF
624-5782-001	31-113	1	778-2948-005	1-23	1
662-0534-010	40-34	1		23-	RF
668-0240-010	40-16	1	778-2949-001	1-24	1
668-0241-010	40-15	1		24-	RF
677-0390-010	11-137	1	778-2950-002	26-78	1
68-1660-26	16-18	2	778-2951-001	1-21	1
	16-60	2		21-	RF
	16-86	4	778-2951-003	1-21	1
	16-183	2		21-	RF
	16-207	2	778-2951-004	1-21	1
	16-225	2		21-	RF
	16-226	2	778-2952-001	1-22	1
	32-114	8		22-	RF
	36-8	2	778-3079-001	22-245	1
	36-11	2	778-6742-000	1-9	1
	36-27	2	778-6825-001	42-1	1
	36-31	2	779-2450-001	21-253	1
	39-26	2	779-2450-003	21-253	1
68-1660-40	19-77	2	779-2450-004	21-253	1
	19-135	2	780-3065-001	21-200	1
	19-187	4		22-198	1
	26-16	2	783-9283-001	1-10	1
	27-20	1		2-	RF
	39-140	1	783-9368-001	1-42	1
	40-37	2		41-	RF
			783-9372-001	2-134	1

NUMERICAL INDEX

PART NUMBER	FIG - ITEM	TTL REQ	PART NUMBER	FIG - ITEM	TTL REQ
783-9479-001	12-92	1		1-32	4
783-9480-001	1-15	1		1-32	6
	12-	RF		1-32	5
783-9490-001	3-60	1		1-32	7
783-9503-001	6-63	1		1-32	7
783-9504-001	9-61	1	790-2235-002	1-31	2
783-9508-001	8-54	1		1-31	2
783-9515-001	41-69	1	790-2235-003	1-32B	1
783-9535-001	5-28	1	790-2235-004	1-32A	1
785-2797-001	14-153	1	790-2483-001	16-218	1
785-2881-001	3-	1	790-2666-004	13-35	1
	3-11	1	790-2666-006	13-35	1
	3-31	1	790-2666-007	13-35	1
789-8499-002	6-43	1	790-2768-001	25-186	1
789-8509-001	6-60	1	790-2768-003	23-119	1
790-0259-001	16-148	1	790-2768-004	25-186	1
	37-137	1	790-2768-005	23-119	1
790-0260-001	16-149	1	790-2769-001	24-83	1
	37-132	1	792-6980-001	1-45	1
790-0266-001	16-135	1		42-	RF
	16-136	1	793-9331-003	1-11	1
	37-10	1		3-	RF
	37-11	1	793-9332-002	1-12	1
790-1048-008	1-18	1		5-	RF
	16-	RF	793-9333-002	1-13	1
790-1048-010	1-18	1		6-	RF
790-1048-020	1-18	1	793-9334-002	1-14	1
	36-	RF	793-9334-006	1-14	1
790-1048-021	1-18	1		9-	RF
	36-	RF	793-9414-001	1-15	1
790-1350-001	16-61	1		11-	RF
	36-25	1	793-9445-001	11-150	1
790-1357-001	16-237	1	793-9822-001	3-57	1
	36-20	1		3-59	1
790-1358-001	16-219	1		5-27	1
	36-4	1		6-62	6
790-1365-001	16-59	1		8-53	2
	36-31	1		9-60	2
790-1367-001	16-224	2		19-222	4
	36-8	2		21-252	4
790-1374-001	16-8	1		22-244	3
790-1377-001	16-58	1	793-9847-001	5-20	1
	36-29	1	793-9852-001	5-19	1
790-1377-002	16-60	1	7943-22	42-9	1
	36-30	1	797-3514-001	19-223	1
790-1378-001	16-223	1	797-3514-006	19-223	1
	36-6	1	797-3514-007	19-223	1
790-1378-002	16-225	1	797-3514-010	19-223	1
	36-7	1	797-3514-011	19-223	1
790-1393-004	16-18	1	797-3514-012	19-223	1
790-1393-005	16-18	1	797-3571-001	1-19	1
790-1401-001	16-240	1		19-	RF
	36-52	1	797-3571-006	1-19	1
790-1402-001	16-239	1		19-	RF
	36-51	1	797-3571-007	1-19	1
790-1472-001	16-242	1		19-	RF
	36-56	1	797-3571-010	1-19	1
790-2017-001	16-4	1		19-	RF
790-2059-001	16-81	1	797-3571-011	1-19	1
	36-2	1		19-	RF
790-2235-001	1-32	5	797-3571-012	1-19	1
	1-32	4		19-	RF
			797-3585-002	1-20	1

NUMERICAL INDEX

PART NUMBER	FIG - ITEM	TTL REQ	PART NUMBER	FIG - ITEM	TTL REQ
				21-19	1
				21-23	1
				21-30	1
				21-37	1
				21-39	1
				21-44	1
				21-53	1
				21-60	1
				21-61	1
				21-71	1
				21-74	1
				21-78	1
				21-79	1
				21-82	1
				21-87	1
				21-101	1
				21-103	1
				21-106	1
				21-107	1
				21-140	1
				21-141	1
				21-152	1
				21-159	1
				21-170	1
				21-178	1
				21-184	1
				21-194	1
				21-196	1
				21-205	1
				21-209	1
				21-211	1
				21-217	1
				21-233	1
				21-238	1
				21-243	1
				22-9	1
				22-20	1
				22-31	1
				22-35	1
				22-51	1
				22-55	1
				22-57	1
				22-65	1
				22-68	1
				22-71	1
				22-76	1
				22-77	1
				22-82	1
				22-83	1
				22-90	1
				22-97	1
				22-101	1
				22-125	1
				22-133	1
				22-134	1
				22-144	1
				22-152	1
				22-167	1
				22-180	1
				22-185	1
				22-186	1
				22-194	1
797-3585-003	20-	RF			
	1-20	1			
797-3585-010	20-	RF			
	1-20	1			
797-3585-011	20-	RF			
	1-20	1			
797-3585-012	20-	RF			
	1-20	1			
8-879	20-	RF			
	4-58	1			
8101-050-651-152	41-6	1			
M					
8101-050-651-471	12-36	1			
M					
	12-51	1			
8111-050-651-222	41-11	1			
M					
8111-050-651-472	12-37	1			
M					
	12-54	1			
	12-58	1			
	41-57	1			
81118079C0G0-828	16-128	1			
C					
	37-116	1			
8121-050-651-104	4-3	1			
Z					
	4-8	1			
	4-15	1			
	4-18	1			
	4-44	1			
	4-84	1			
	12-16	1			
	12-35	1			
	12-66	1			
	12-83	1			
	12-87	1			
	31-2	1			
	31-6	1			
	31-51	1			
	31-56	1			
	31-110	1			
	41-4	1			
	41-16A	1			
	41-32	1			
8121-100-5R102K	31-53	1			
8121-100-5R103K	4-78	1			
8123-000C0G0151J	11-111	1			
	11-127	1			
8123-000C0G0221F	11-28	1			
8123-000C0G0331J	11-54	1			
8123A18BC0G471F	11-34	1			
	11-39	1			
	11-40	1			
	11-49	1			
8131-050-651-104	19-18	1			
M					
	19-28	1			
	19-113	1			
	19-175	1			
	21-8	1			
	21-9	1			

NUMERICAL INDEX

PART NUMBER	FIG - ITEM	TTL REQ	PART NUMBER	FIG - ITEM	TTL REQ
	22-195	1		4-76	1
	22-208	1		4-80	1
	22-209	1		4-81	1
	22-225	1		4-85	1
	23-37	1		4-89	1
	23-97	1		4-100	1
	24-27	1		4-107	1
	24-42	1		4-111	1
	25-32	1		4-114	1
	25-177	1		31-30	1
	29-27	1		31-36	1
	30-8	1		31-47	1
	30-18	1		31-48	1
	30-27	1		31-72	1
	30-29	1		31-80	1
	33-4	1		31-81	1
	33-10	1		31-85	1
	33-11	1		31-86	1
	33-22	1		31-88	1
	33-24	1		31-95	1
	33-96	1		31-98	1
	34-18	1	997F18	21-75	1
	34-21	1		22-72	1
	35-20	1			
	35-23	1			
	37-29	1			
	37-30	1			
	37-38	1			
	37-81	1			
	37-99	1			
	37-100	1			
	37-101	1			
	37-105	1			
	37-138	1			
	38-31	1			
	38-32	1			
	38-35	1			
	38-36	1			
	38-37	1			
	38-40	1			
	38-41	1			
	38-45	1			
	38-49	1			
	38-53	1			
8131-050-651-474	12-61	1			
M					
8131-100CG332K	23-10	1			
	25-68	1			
8131-100W5R104K	4-40	1			
	4-41	1			
	4-101	1			
	4-102	1			
	31-20	1			
	31-21	1			
	31-40	1			
	31-41	1			
	31-82	1			
8942	25-1	1			
913-3279-430	4-27	1			
	4-30	1			
	4-49	1			
	4-54	1			
	4-75	1			



## 4. REFERENCE DESIGNATION INDEX

REFERENCE DESIGNATION	FIG - ITEM	PART NUMBER	REFERENCE DESIGNATION	FIG - ITEM	PART NUMBER
A1	1-24	778-2949-001	A1R24	24-73	RCR07G2270KS
A1	24-	778-2949-001	A1R25	24-77	RCR20G103KS
A1CR1	24-61	1N914	A1R26	24-2	RCR07G222KS
A1CR2	24-53	1N914	A1R27	24-4	RCR07G120KS
A1CR3	24-70	1N4003	A1R28	24-8	RCR07G472KS
A1CR4	24-71	1N4003	A1R29	24-7	RCR07G472KS
A1CR5	24-6	1N914	A1R3	24-69	T055-5-62K1F
A1CR6	24-16	1N914	A1R30	24-13	RCR07G183KS
A1CR7	24-37	1N4003	A1R31	24-14	RCR07G272KS
A1CR8	24-38	1N4003	A1R32	24-19	RCR07G472KS
A1C1	24-20	500D187G050DX5	A1R33	24-17	RCR07G680KS
A1C10	24-31	2C067103X0101A3	A1R34	24-26	RW67V221
A1C11	24-75	2C067103X0101A3	A1R35	24-5	RCR07G124KS
A1C12	24-34	2C067103X0101A3	A1R36	24-67	RCR07G102KS
A1C13	24-1	CM04FD181103	A1R37	24-33	RCR07G102KS
A1C14	24-10	CK06RX394K	A1R4	24-32	T055-4-64K1F
A1C15	24-15	M39003-01-2108	A1R4	24-32	T055-5361-1F
A1C2	24-21	500D187G050DX5	A1R4	24-32	T055-5901-1F
A1C3	24-22	500D187G050DX5	A1R4	24-32	T055-5-62K1F
A1C4	24-27	A131-050-651-104 M	A1R4	24-32	T055-4530-1F
A1C4	24-27	D71F511G0	A1R4	24-32	T055-4871-1F
A1C5	24-78	CM06FD511103	A1R4	24-32	T055-4990-1F
A1C6	24-42	A131-050-651-104 M	A1R4	24-32	T055-5760-1F
A1C7	24-62	M39003-01-2073	A1R4	24-32	T055-4750-1F
A1C8	24-55	M39003-01-2073	A1R4	24-32	T055-5-11K1F
A1C9	24-54	M39003-01-2022	A1R4	24-32	T055-4421-1F
A1K1	24-64	3SAV1119A2	A1R4	24-32	T055-5230-1F
A1K2	24-56	3SAV1119A2	A1R4	24-32	T055-5490-1F
A1Q1	24-40	2N3741	A1R5	24-25	T055-3011-1F
A1Q2	24-57	2N2222A	A1R6	24-29	T055-17400-1F
A1Q3	24-11	2N2222A	A1R6	24-29	T055-1692-1F
A1Q4	24-12	2N2222A	A1R6	24-29	T055-1872-1F
A1Q5	24-18	2N2222A	A1R6	24-29	T055-17-8K1F
A1Q6	24-3	CB1028	A1R6	24-29	T055-18200-1F
A1R1	24-68	RCR07G101KS	A1R7	24-28	T055-5-62K1F
A1R10	24-76	RCR20G122KS	A1R8	24-24	T055-3011-1F
A1R11	24-36	RCR07G101KS	A1R9	24-79	RW70UR237F
A1R12	24-39	RCR07G101KS	A1U1	24-72	U5R7723393
A1R13	24-58	RW70UR237F	A1U2	24-23	U5R7723393
A1R14	24-59	RW70UR237F	A1U3	24-35	U5R7723393
A1R15	24-43	T055-1-96K1F	A1U4	24-45	SG41
A1R16	24-44	T055-5230-1F	A1VR1	24-74	1N753A
A1R16	24-44	T055-4530-1F	A1VR2	24-46	1N4562B
A1R16	24-44	T055-5901-1F	A1VR3	24-81	1N750A
A1R16	24-44	T055-5-11K1F	A1VR4	24-50	1N2818R
A1R16	24-44	T055-5760-1F	A1VR5	24-9	1N753A
A1R16	24-44	T055-4990-1F	A10	9-	793-9334-006
A1R16	24-44	T055-5-62K1F	A10	8-	793-9334-002
A1R16	24-44	T055-4-64K1F	A10	1-14	793-9334-006
A1R16	24-44	T055-5361-1F	A10	1-14	793-9334-002
A1R16	24-44	T055-5490-1F	A10C1	9-57	262C067222X0101B
A1R16	24-44	T055-4421-1F	A10C1	8-49	262C067222X0101B
A1R16	24-44	T055-4750-1F	A10C10	9-42	262C067222X0101B
A1R16	24-44	T055-4871-1F	A10C10	8-22	262C067222X0101B
A1R17	24-60	RCR05G391K	A10C11	9-49	262C067222X0101B
A1R18	24-66	RCR32G121KS	A10C11	8-39	262C067222X0101B
A1R19	24-52	RCR07G472KS	A10C12	9-51	262C067222X0101B
A1R2	24-63	RS2B00FR4000F	A10C12	8-44	262C067222X0101B
A1R20	24-80	RCR05G272K	A10C13	9-40	262C067222X0101B
A1R21	24-48	RCR05G681K	A10C13	8-34	262C067222X0101B
A1R22	24-49	RCR05G103K	A10C14	9-35	262C067222X0101B
A1R23	24-30	RCR07G180KS	A10C14	8-31	262C067222X0101B
			A10C15	8-26	262C067222X0101B
			A10C15	9-30	262C067222X0101B

## REFERENCE DESIGNATION INDEX

REFERENCE DESIGNATION	FIG - ITEM	PART NUMBER	REFERENCE DESIGNATION	FIG - ITEM	PART NUMBER
A10C16	8-24	262C067222X0101B	A10U14	8-14	RF3202K
A10C16	9-28	262C067222X0101B	A10U21	9-56	N8263P
A10C17	8-21	262C067222X0101B	A10U21	8-48	N8263P
A10C17	9-24	262C067222X0101B	A10U22	8-8	SF33
A10C18	8-2	262C067103X0101B	A10U22	9-9	SF33
A10C18	8-2	C22A103M	A10U23	9-14	SM153
A10C18	9-3	C22A103M	A10U23	8-13	SM153
A10C18	9-3	262C067103X0101B	A10U24	9-16	SF203
A10C19	8-1	M39003-01-2029	A10U24	8-16	SF203
A10C19	9-2	M39003-01-2029	A10U33	9-18	SN74L00T
A10C2	9-50	262C067222X0101B	A10U34	9-19	SF113
A10C2	8-42	262C067222X0101B	A10U34	8-17	SF113
A10C20	9-52	M39003-01-2029	A10U41	9-47	N8263P
A10C20	8-43	M39003-01-2029	A10U41	8-40	N8263P
A10C21	9-44	M39003-01-2029	A10U42	9-46	SN74L00T
A10C21	8-37	M39003-01-2029	A10U43	9-20	SN74L10T
A10C3	9-38	262C067222X0101B	A10U44	9-22	SG143
A10C3	8-36	262C067222X0101B	A10U44	8-19	SG143
A10C4	9-55	262C067222X0101B	A10U52	9-43	SN74L04T
A10C4	8-47	262C067222X0101B	A10U53	9-25	SN74L00T
A10C5	8-11	262C067222X0101B	A10U54	9-23	N8280J
A10C5	9-17	262C067222X0101B	A10U54	8-20	N8280J
A10C6	9-10	262C067222X0101B	A10U61	9-39	SM153
A10C6	8-9	262C067222X0101B	A10U61	8-33	SM153
A10C7	9-12	262C067222X0101B	A10U62	9-36	SN74L00T
A10C7	8-12	262C067222X0101B	A10U63	9-27	SN74L04T
A10C8	9-15	262C067222X0101B	A10U64	8-23	SG193
A10C8	8-15	262C067222X0101B	A10U64	9-26	SG193
A10C9	9-21	262C067222X0101B	A10U71	9-37	SM153
A10C9	8-18	262C067222X0101B	A10U71	8-32	SM153
A10L1	9-1	MS75084-07	A10U72	9-34	SF33
A10L1	8-50	MS75084-07	A10U72	8-30	SF33
A10L2	9-53	MS75084-07	A10U73	9-31	SF113
A10L2	8-45	MS75084-07	A10U73	8-27	SF113
A10L3	9-41	MS75084-07	A10U74	8-25	SG143
A10L3	8-35	MS75084-07	A10U74	9-29	SG143
A10P1	9-59	141-1002-0003	A11	6-	793-9333-002
A10P1	8-52	141-1002-0003	A11	1-13	793-9333-002
A10P4	9-58	141-1002-0003	A11C1	6-54	262C067222X0101B
A10P4	8-51	141-1002-0003	A11C10	6-27	262C067222X0101B
A10R1	9-6	RCR07G472KS	A11C11	6-11	M39003-01-2029
A10R1	8-5	RCR07G472KS	A11C12	6-12	262C067222X0101B
A10R2	9-8	RCR07G102KS	A11C13	6-14	M39003-01-2029
A10R2	8-7	RCR07G102KS	A11C14	6-16	262C067222X0101B
A10R3	9-5	RCR07G332KS	A11C15	6-8	262C025151X5101B
A10R3	8-4	RCR07G332KS	A11C16	6-9	262C025151X5101B
A10R4	9-54	RCR07G822KS	A11C17	6-32	DM5F331J050WV
A10R4	8-46	RCR07G822KS	A11C18	6-33	DM5F331J050WV
A10R5	9-48	RCR07G332KS	A11C19	6-30	CK05BX103K
A10R5	8-41	RCR07G332KS	A11C2	6-53	M39003-01-2029
A10R6	9-45	RCR07G822KS	A11C3	6-5	CK05BX273K
A10R6	8-38	RCR07G822KS	A11C4	6-1	CK05BX103K
A10R7	9-32	RCR07G332KS	A11C5	6-2	CK05BX103K
A10R7	8-28	RCR07G332KS	A11C6	6-51	M39003-01-2065
A10R8	9-33	RCR07G822KS	A11C7	6-25	M39003-01-2029
A10R8	8-29	RCR07G822KS	A11C8	6-24	262C067222X0101B
A10U11	9-4	SM153	A11C9	6-22	M39003-01-2029
A10U11	8-3	SM153	A11C9	6-22	M39003-01-2018
A10U12	9-7	RG3222K	A11L1	6-3	21801MPORM5PCT
A10U12	8-6	RG3222K	A11L2	6-52	MS75083-09
A10U13	9-11	RF3202K	A11L3	6-49	MS75084-08
A10U13	8-10	RF3202K	A11L4	6-41	240-2711-300
A10U14	9-13	RF3202K	A11L5	6-31	MS75084-02

## REFERENCE DESIGNATION INDEX

REFERENCE DESIGNATION	FIG - ITEM	PART NUMBER	REFERENCE DESIGNATION	FIG - ITEM	PART NUMBER
A11L6	6-23	4S75084-14	A11U32	6-48	SG63
A11L7	6-28	4S75084-15	A11U33	6-34	N8424J
A11P1	6-59	141-1002-0003	A11U34	6-29	SN74L02T
A11P2	6-61	140-0530-9013	A11U34	6-29	SN74L73T
A11P3	6-58	141-1002-0003	A11U34	6-29	SN7473W
A11P4	6-57	141-1002-0003	A11U41	6-47	SN74L10T
A11P6	6-56	141-1002-0003	A11U42	6-45	N8424J
A11P7	6-55	141-1002-0003	A11U43	6-40	SN74L10T
A11R1	6-4	RCR05G100K	A11U44	6-38	SN74L00T
A11R1	6-4	RCR05G120K	A11U44	6-38	SN7400W
A11R1	6-4	RCR05G150K	A11U45	6-36	SG223
A11R1	6-4	RCR05G180K	A11U46	6-42	609-0784-002
A11R1	6-4	RCR05G220K	A11U47	6-43	789-8499-002
A11R1	6-4	RCR05G270K	A12	1-12	793-9332-002
A11R1	6-4	RCR05G330K	A12	5-	793-9332-002
A11R1	6-4	RCR05G390K	A12C1	5-22	M39003-01-2029
A11R1	6-4	RCR05G470K	A12C2	5-10	262C067222X0101B
A11R1	6-4	RCR05G560K	A12C3	5-7	262C067222X0101B
A11R1	6-4	RCR05G680K	A12C4	5-1	262C067222X0101B
A11R1	6-4	RCR05G820K	A12C5	5-4	262C067222X0101B
A11R1	6-4	RCR05G101K	A12C6	5-24	262C067222X0101B
A11R1	6-4	RCR05G121K	A12C7	5-15	262C067222X0101B
A11R1	6-4	RCR05G151K	A12C8	5-21	262C067222X0101B
A11R1	6-4	RCR05G181K	A12L1	5-23	MS18130-19
A11R1	6-4	RCR05G221K	A12L2	5-16	240-2711-300
A11R1	6-4	RCR05G271K	A12L3	5-17	240-2711-300
A11R1	6-4	RCR05G331K	A12L4	5-18	240-2711-300
A11R10	6-46	RCR05G472K	A12P19	5-26	141-1002-0003
A11R2	6-35	RCR05G100K	A12U1	5-12	SF212
A11R2	6-35	RCR05G120K	A12U10	5-25	SM143
A11R2	6-35	RCR05G150K	A12U11	5-13	SG222
A11R2	6-35	RCR05G180K	A12U12	5-20	793-9A47-001
A11R2	6-35	RCR05G220K	A12U13	5-19	793-9852-001
A11R2	6-35	RCR05G270K	A12U2	5-9	SF213
A11R2	6-35	RCR05G330K	A12U3	5-11	SF213
A11R2	6-35	RCR05G390K	A12U4	5-14	SF213
A11R2	6-35	RCR05G470K	A12U5	5-3	SF202
A11R2	6-35	RCR05G560K	A12U6	5-5	SG193
A11R2	6-35	RCR05G680K	A12U7	5-6	SF203
A11R2	6-35	RCR05G820K	A12U8	5-8	SF33
A11R2	6-35	RCR05G101K	A12U9	5-2	SM153
A11R2	6-35	RCR05G121K	A13	3-	793-9331-003
A11R2	6-35	RCR05G151K	A13	1-11	793-9331-003
A11R2	6-35	RCR05G181K	A13CR1	3-52	353-3338-001
A11R2	6-35	RCR05G221K	A13CR2	3-44	353-3338-001
A11R2	6-35	RCR05G271K	A13C1	3-8	M39003-03-0024
A11R2	6-35	RCR05G331K	A13C10	3-33	M39003-01-2050
A11R3	6-23	RCR05G3R3JS	A13C11	3-9	M39003-03-0024
A11R4	6-28	RCR05G3R3JS	A13C12	3-16	CK06BX104K
A11R5	6-13	RCR05G3R3JS	A13C13	3-29	CK06BX104K
A11R6	6-17	RCR05G3R3JS	A13C14	3-35	M39003-01-2050
A11R7	6-39	RCR05G471K	A13C2	3-3	CM05FD101J03
A11R8	6-37	RCR05G472K	A13C3	3-10	M39003-01-2050
A11R9	6-44	RCR05G471K	A13C3	3-10	M39003-03-0059
A11U11	6-7	SG223	A13C4	3-18	CK06BX104K
A11U12	6-10	N8292Q	A13C5	3-20	M39003-01-2050
A11U13	6-15	N8292Q	A13C5	3-20	M39003-03-0059
A11U14	6-19	SF103	A13C6	3-21	M39003-03-0024
A11U15	6-21	N8281J	A13C7	3-24	CM05FD101J03
A11U21	6-6	SN74L02T	A13C8	3-22	M39003-01-2050
A11U21	6-6	SN74L73T	A13C9	3-34	CK06BX104K
A11U21	6-6	SN7473W	A13C15	3-20A	M39003-03-0059
A11U23	6-18	N8293Q	A13LPF1	3-17	4-11634
A11U24	6-20	N8293Q	A13LPF2	3-37	4-11633
A11U25	6-26	N8280J	A13L1	3-19	MS90537-41
A11U31	6-50	SN74L00T	A13L2	3-36	MS90537-41
A11U31	6-50	SN7400W	A13L3	3-23	240-2711-300

## REFERENCE DESIGNATION INDEX

REFERENCE DESIGNATION	FIG - ITEM	PART NUMBER	REFERENCE DESIGNATION	FIG - ITEM	PART NUMBER
A13P1	3-56	141-1002-0003	A13VC01	3-47	607-7721-001
A13P6	3-58	141-1002-0003	A13VC02	3-46	607-7722-001
A13Q1	3-53	352-7500-451	A14	1-10	7A3-92A3-001
A13Q2	3-42	352-7500-451	A14	2-	7A3-92A3-001
A13Q3	3-50	352-7500-451	A14CR1	2-128	1N914
A13Q4	3-40	352-7500-451	A14CR2	2-66	1N914
A13R1	3-5	RCR05G222K	A14C1	2-50	150D105X9035A2
A13R10	3-30	RCR05G222K	A14C10	2-104	CK05BX104M
A13R11	3-31	RCR05G100K	A14C11	2-118	CK05BX103M
A13R12	3-26	RN55D3481F	A14C12	2-93	DM5F391J050WV
A13R12	3-26	RN55D6491F	A14C13	2-99	DM5F391J050WV
A13R13	3-25	RN55D6491F	A14C14	2-100	DM5F391J050WV
A13R14	3-32	RCR05G103K	A14C15	2-92	CK05BX103M
A13R14	3-32	RCR05G123K	A14C16	2-102	DM5F221J050WV
A13R14	3-32	RCR05G153K	A14C17	2-14	M39003-01-2044
A13R14	3-32	RCR05G183K	A14C18	2-124	CK05BX103M
A13R14	3-32	RCR05G223K	A14C19	2-64	M39003-01-2014
A13R14	3-32	RCR05G273K	A14C2	2-54	K1P35
A13R14	3-32	RCR05G333K	A14C20	2-56	CK05BX102M
A13R14	3-32	RCR05G393K	A14C21	2-117	M39003-01-2014
A13R14	3-32	RCR05G333K	A14C22	2-73	150D106X9020R2
A13R15	3-41	T055-2210-1F	A14C24	2-25	150D106X9020R2
A13R15	3-41	RCR07G222KS	A14C25	2-37	150D106X9020R2
A13R16	3-45	C3472K	A14C26	2-129	CK05BX103M
A13R16	3-45	RCR05G472K	A14C27	2-47	CK05BX103M
A13R17	3-43	C3333K	A14C28	2-123	CK05BX103M
A13R17	3-43	RCR07G333KS	A14C29	2-17	CK05BX103M
A13R18	3-39	C3682K	A14C3	2-7	CK05BX103M
A13R18	3-39	RCR05G682K	A14C30	2-108	CK05BX103M
A13R19	3-38	C3103K	A14C31	2-20	CK05BX103M
A13R19	3-38	RCR05G103K	A14C32	2-97	CK05BX103M
A13R2	3-2	RCR05G100K	A14C33	2-28	CK05BX103M
A13R20	3-12	RCR05G103K	A14C34	2-40	CK05BX103M
A13R20	3-12	RCR05G123K	A14C35	2-36	CK05BX103M
A13R20	3-12	RCR05G153K	A14C36	2-107	CK05BX102K
A13R20	3-12	RCR05G183K	A14C4	2-130	G544BX102M
A13R20	3-12	RCR05G223K	A14C5	2-88	DM5F391J050WV
A13R20	3-12	RCR05G273K	A14C6	2-87	DM5F391J050WV
A13R20	3-12	RCR05G333K	A14C7	2-91	DM5F391J050WV
A13R20	3-12	RCR05G393K	A14C8	2-106	DM5F221J050WV
A13R20	3-12	RCR05G273K	A14C9	2-120	DM5F221J050WV
A13R21	3-11	RN55D6A11F	A1401	2-113	2N2369A
A13R22	3-13	RN55D2431F	A1402	2-111	2N2222
A13R23	3-14	RCR05G150K	A1403	2-76	2N2907
A13R24	3-16A	RCR07G331KS	A1404	2-80	2N2222
A13R3	3-7	RN55D3481F	A1405	2-69	2N1671
A13R3	3-7	RN55D6491F	A1406	2-62	2N2222
A13R4	3-6	RN55D6491F	A1407	2-55	2N2369A
A13R5	3-1	RCR05G103K	A1408	2-34	2N2369A
A13R5	3-1	RCR05G123K	A1409	2-32	2N2222
A13R5	3-1	RCR05G153K	A14R1	2-19	RCR05G102K
A13R5	3-1	RCR05G183K	A14R10	2-52	RCR05G223K
A13R5	3-1	RCR05G223K	A14R11	2-48	RCR05G472K
A13R5	3-1	RCR05G273K	A14R12	2-49	RCR05G223K
A13R5	3-1	RCR05G333K	A14R13	2-131	RCR05G391K
A13R5	3-1	RCR05G393K	A14R14	2-133	RCR05G391K
A13R5	3-1	RCR05G333K	A14R15	2-84	RCR05G472K
A13R6	3-49	C3682K	A14R16	2-81	RCR05G223K
A13R6	3-49	RCR05G682K	A14R17	2-82	RCR05G223K
A13R7	3-55	T055-2210-1F	A14R18	2-83	RCR05G223K
A13R7	3-55	RCR07G222KS	A14R19	2-101	RCR05G472K
A13R8	3-51	T055-5490-1F	A14R2	2-18	RCR05G223K
A13R8	3-51	RCR05G222K	A14R20	2-95	RCR05G472K
A13R9	3-48	C3103K			
A13R9	3-48	RCR05G103K			
A13J1	3-4	U5R7723312			
A13J2	3-27	U5R7723312			
A13J3	3-15	LM104H			

## REFERENCE DESIGNATION INDEX

REFERENCE DESIGNATION	FIG - ITEM	PART NUMBER	REFERENCE DESIGNATION	FIG - ITEM	PART NUMBER
A14R21	2-94	RCR05G472K	A14U39	2-103	SG383
A14R22	2-105	RCR05G223K	A14U4	2-41	U4L9327592
A14R23	2-90	RCR05G223K	A14U40	2-98	SG143
A14R24	2-89	RCR05G223K	A14U41	2-96	SG143
A14R25	2-86	RCR05G472K	A14U5	2-38	U4L9327592
A14R26	2-85	RCR05G472K	A14U6	2-33	U4L9327592
A14R27	2-75	RCR05G103K	A14U7	2-30	MC946F
A14R28	2-71	RCR05G104K	A14U8	2-3	MC946F
A14R29	2-67	RCR05G270K	A14U9	2-2	MC946F
A14R3	2-11	RCR05G102K	A2	1-23	778-2948-003
A14R30	2-125	RCR05G271K	A2	1-23	778-2948-004
A14R31	2-63	RCR05G102K	A2	1-23	778-2948-005
A14R32	2-65	RCR05G472K	A2	1-23	778-2948-002
A14R33	2-60	RCR05G472K	A2	25-	778-2948-002
A14R34	2-59	RCR05G821K	A2	23-	778-2948-003
A14R35	2-58	RCR05G332K	A2	25-	778-2948-004
A14R36	2-57	RCR05G681K	A2	23-	778-2948-005
A14R37	2-77	RCR05G273K	A2A1	25-1	609-0552-001
A14R38	2-74	RCR05G103K	A2A1	25-1	618-7705-001
A14R4	2-43	RCR05G223K	A2A1	23-1	618-7705-001
A14R40	2-112	RCR05G472K	A2A1	23-1	609-0552-002
A14R41	2-79	RCR05G102K	A2A1	25-1	609-0552-002
A14R42	2-78	RCR05G223K	A2A1	23-1	618-7705-002
A14R43	2-72	RCR05G123K	A2A1	32-	609-0552-002
A14R44	2-68	RCR05G270K	A2A1	33-	618-7705-002
A14R45	2-61	RCR05G101K	A2A1	32-	609-0552-001
A14R5	2-116	RCR05G472K	A2A1	33-	618-7705-001
A14R6	2-35	RCR05G222K	A2A1CR1	33-46	MV1404
A14R7	2-119	RCR05G223K	A2A1CR1	32-13	MV1404
A14R8	2-31	RCR20G220KS	A2A1CR3	32-55	MV1404
A14R9	2-53	RCR05G472K	A2A1CR3	33-30	MV1404
A14U1	2-1	U4L9327592	A2A1CR4	32-73	1N914
A14U10	2-45	MC946F	A2A1CR4	33-66	1N914
A14U11	2-42	MC946F	A2A1CR5	33-51	1N914
A14U12	2-39	MC946F	A2A1CR5	32-19	1N914
A14U13	2-29	SG143	A2A1CR6	32-24	1N914
A14U14	2-4	SG143	A2A1CR6	33-52	1N914
A14U15	2-5	SG143	A2A1CR7	33-61	1N914
A14U16	2-9	SG143	A2A1CR7	32-32	1N914
A14U17	2-12	SG143	A2A1CR8	32-33	1N914
A14U18	2-15	SG143	A2A1CR8	33-7	1N914
A14U19	2-23	SG383	A2A1C1	33-76	DM5F361J050WV
A14U2	2-46	U4L9327592	A2A1C1	32-75	DM5F361J050WV
A14U20	2-27	SG193	A2A1C10	33-26	DM5F401J050WV
A14U21	2-6	U3M930659X	A2A1C10	32-58	DM5F401J050WV
A14U22	2-8	U3M930659X	A2A1C11	32-59	CK05BX103M
A14U23	2-10	U3M930659X	A2A1C11	33-89	2C067103X0101A3
A14U24	2-13	U3M930659X	A2A1C12	32-72	CK05BX103M
A14U25	2-16	U3M930659X	A2A1C12	33-85	2C067103X0101A3
A14U26	2-22	SG193	A2A1C13	33-33	TC20-82
A14U27	2-26	SF53	A2A1C13	32-3	TC20-110
A14U28	2-132	SG383	A2A1C13	32-3	DA934-024
A14U29	2-127	SG193	A2A1C13	33-33	DA934-025
A14U3	2-44	U4L9327592	A2A1C13	33-33	TC20-110
A14U30	2-121	SG193	A2A1C13	32-3	TC20-82
A14U31	2-115	SG383	A2A1C13	33-33	TC20-89
A14U32	2-109	SG143	A2A1C13	33-33	TC20-81
A14U33	2-21	SG143	A2A1C13	32-3	TC20-89
A14U34	2-24	SF53	A2A1C13	32-3	DM5E200D050WV
A14U35	2-51	SG143	A2A1C13	33-33	TC20-94
A14U36	2-126	SG43	A2A1C13	33-33	TC20-92
A14U37	2-122	SG143	A2A1C13	32-3	TC20-90
A14U38	2-110	SG143	A2A1C13	33-33	TC20-90

REFERENCE DESIGNATION INDEX

REFERENCE DESIGNATION	FIG - ITEM	PART NUMBER	REFERENCE DESIGNATION	FIG - ITEM	PART NUMBER
A2A1C13	32-3	TC20-94	A2A1C33	33-48	2C067103X0101A3
A2A1C13	32-3	DA934-025	A2A1C33	32-69	CK05BX103M
A2A1C13	33-33	DA934-024	A2A1C35	33-75	1251-003
A2A1C13	33-33	DM5E200D050WV	A2A1C35	32-10	1251-003
A2A1C13	32-3	TC20-81	A2A1C36	33-71	1251-003
A2A1C13	32-3	DA934-023	A2A1C36	32-20	1251-003
A2A1C13	33-33	DA934-023	A2A1C37	32-23	1251-003
A2A1C13	32-3	TC20-92	A2A1C37	33-70	1251-003
A2A1C15	33-34	2C067103X0101A3	A2A1C38	32-25	1251-003
A2A1C15	32-54	CK05BX103M	A2A1C38	33-68	1251-003
A2A1C16	33-32	DM5E240D050WV	A2A1C39	33-67	1251-003
A2A1C16	32-53	DM5E240D050WV	A2A1C39	32-27	1251-003
A2A1C17	33-35	DM5F401J050WV	A2A1C4	33-44	2C067103X0101A3
A2A1C17	32-67	DM5F401J050WV	A2A1C4	32-16	CK05BX103M
A2A1C18	32-4	DM5F361J050WV	A2A1C40	32-28	1251-003
A2A1C18	33-83	DM5F361J050WV	A2A1C40	33-65	1251-003
A2A1C19	32-87	2C067104X0101A3	A2A1C41	32-38	DM5E680J050WV
A2A1C19	33-10	8131-050-651-104 M	A2A1C42	32-96	DM5E200D050WV
A2A1C2	33-81	2C067103X0101A3	A2A1C43	32-97	D71F821J0
A2A1C2	32-9	CK05BX103M	A2A1C44	32-94	D71F821J0
A2A1C20	32-31	2C067104X0101A3	A2A1C45	32-7	DM5F201J050WV
A2A1C20	33-4	8131-050-651-104 M	A2A1C45	33-37	DM5F201J050WV
A2A1C21	33-11	8131-050-651-104 M	A2A1C46	33-11A	DM5F181J050WV
A2A1C21	32-34	2C067104X0101A3	A2A1C5	33-47	TC20-81
A2A1C22	32-46	CK05BX103M	A2A1C5	32-15	TC20-81
A2A1C22	33-17	2C067103X0101A3	A2A1C5	32-15	TC20-90
A2A1C23	32-82	2C067104X0101A3	A2A1C5	32-15	TC20-89
A2A1C23	33-24	8131-050-651-104 M	A2A1C5	33-47	DA934-023
A2A1C24	33-49	2C067103X0101A3	A2A1C5	32-15	DA934-023
A2A1C24	32-83	CK05BX103M	A2A1C5	33-47	TC20-110
A2A1C25	33-96	8131-050-651-104 M	A2A1C5	33-47	DA934-025
A2A1C25	32-50	2C067104X0101A3	A2A1C5	32-15	TC20-110
A2A1C26	32-86	DM5F201J050WV	A2A1C5	33-47	TC20-81
A2A1C27	32-37	CK05BX103M	A2A1C5	33-47	DA934-024
A2A1C27	33-16	2C067103X0101A3	A2A1C5	32-15	TC20-82
A2A1C28	32-39	DM5E560J050WV	A2A1C5	32-15	DA934-024
A2A1C29	32-35	DM5E330J050WV	A2A1C5	32-15	TC20-94
A2A1C29	33-22	8131-050-651-104 M	A2A1C5	33-47	TC20-94
A2A1C3	33-38	DM5E430J050WV	A2A1C5	33-47	TC20-82
A2A1C3	32-17	DM5E360J050WV	A2A1C5	32-15	DM5E200D050WV
A2A1C3	33-38	DM5E300J050WV	A2A1C5	32-15	TC20-92
A2A1C3	33-38	DM5E330J050WV	A2A1C5	32-15	DA934-025
A2A1C3	32-17	DM5E240D050WV	A2A1C5	32-15	DM5E200D050WV
A2A1C3	33-38	DM5E200D050WV	A2A1C5	33-47	TC20-90
A2A1C3	32-17	DM5E330J050WV	A2A1C5	33-47	TC20-92
A2A1C3	32-17	DM5E270J050WV	A2A1C7	33-78	2C067103X0101A3
A2A1C3	33-38	DM5E270J050WV	A2A1C7	32-105	CK05BX103M
A2A1C3	33-38	DM5E360J050WV	A2A1C8	32-103	DM5F271J050WV
A2A1C3	32-17	DM5E200D050WV	A2A1C8	33-36	DM5F271J050WV
A2A1C3	33-38	DM5E240D050WV	A2A1C9	32-12	DM5F101J050WV
A2A1C3	32-17	DM5E300J050WV	A2A1C9	33-73	DM5F101J050WV
A2A1C3	32-17	DM5E430J050WV	A2A1K1	32-111	3SBC1380A2
A2A1C30	33-59	DM5F181J050WV	A2A1K1	33-98	M5757-9-027
A2A1C30	32-71	2C067104X0101A3	A2A1K2	32-112	3SBC1380A2
A2A1C31	32-98	2C067104X0101A3	A2A1L1	32-90	MS90537-60
A2A1C32	32-30	CK05BX103M	A2A1L1	33-62	MS90537-60
A2A1C32	33-63	2C067103X0101A3	A2A1L2	32-76	MS90537-41
			A2A1L2	33-91	MS90537-41
			A2A1L3	33-50	MS90537-41
			A2A1L3	32-26	MS90537-41
			A2A1L4	32-29	MS90537-41
			A2A1L4	33-57	MS90537-41
			A2A1L5	33-21	M575055-11

## REFERENCE DESIGNATION INDEX

REFERENCE DESIGNATION	FIG - ITEM	PART NUMBER	REFERENCE DESIGNATION	FIG - ITEM	PART NUMBER
A2A1L5	32-81	MS75085-11	A2A1R26	33-23	RCR05G222K
A2A1L6	32-49	MS75085-11	A2A1R27	32-41	RCR05G682K
A2A1L6	33-25	MS75085-11	A2A1R27	33-94	RCR05G682K
A2A1L7	33-14	MS90537-4A	A2A1R28	33-97	RCR05G102K
A2A1P2	33-104	141-1002-0002	A2A1R28	32-79	RCR05G102K
A2A1P2	32-117	141-1002-0002	A2A1R29	33-95	RCR05G392K
A2A1P3	32-118	141-1002-0002	A2A1R29	32-43	RCR05G392K
A2A1P3	33-105	141-1002-0002	A2A1R3	33-43	RCR05G474K
A2A1Q1	32-63	S29119	A2A1R30	32-48	RCR05G392K
A2A1Q1	33-80	S29119	A2A1R30	33-93	RCR05G392K
A2A1Q2	32-70	S29119	A2A1R31	32-85	RCR05G182K
A2A1Q2	33-87	S29119	A2A1R31	33-15	RCR05G153K
A2A1Q3	32-99	2N2222A	A2A1R32	32-36	RCR05G562K
A2A1Q3	33-54	2N2222A	A2A1R32	32-36	RCR05G122K
A2A1Q4	33-12	2N2222A	A2A1R32	33-18	RCR05G561K
A2A1Q4	32-77	2N2222A	A2A1R32	32-36	RCR05G561K
A2A1Q5	32-93	2N2222A	A2A1R32	32-36	RCR05G472K
A2A1Q5	33-2	2N2222A	A2A1R32	33-18	RCR05G682K
A2A1Q6	33-13	2N2222A	A2A1R32	32-36	RCR05G682K
A2A1R1	33-74	RCR05G472JS	A2A1R32	32-36	RCR05G272K
A2A1R1	32-65	RCR05G472K	A2A1R32	33-18	RCR05G122K
A2A1R1	32-65	RCR05G472JS	A2A1R32	32-36	RCR05G222K
A2A1R1	32-65	RCR05G472K	A2A1R32	33-18	RCR05G332K
A2A1R1	32-51	RCR05G474K	A2A1R32	33-18	RCR05G562K
A2A1R10	33-29	RCR05G474K	A2A1R32	33-18	RCR05G222K
A2A1R11	32-5	RCR05G153K	A2A1R32	33-18	RCR05G392K
A2A1R11	33-84	RCR05G133JS	A2A1R32	33-18	RCR05G472K
A2A1R11	32-5	RCR05G153K	A2A1R32	33-18	RCR05G152K
A2A1R11	32-5	RCR05G133JS	A2A1R32	33-18	RCR05G272K
A2A1R12	32-6	RCR05G153K	A2A1R32	32-36	RCR05G332K
A2A1R12	33-82	RCR05G153JS	A2A1R32	32-36	RCR05G392K
A2A1R12	32-6	RCR05G153K	A2A1R32	33-18	RCR05G182K
A2A1R12	32-6	RCR05G153JS	A2A1R32	32-36	RCR05G182K
A2A1R12	32-6	RCR05G153K	A2A1R32	33-18	RCR05G123K
A2A1R13	32-104	RCR05G474K	A2A1R33	33-60	RCR05G123K
A2A1R13	32-21	RCR05G103K	A2A1R33	32-84	RCR05G680K
A2A1R13	33-53	RCR05G103K	A2A1R34	33-103	RT22C2L203
A2A1R14	32-102	RCR05G222K	A2A1R34	32-108	3292L1-203
A2A1R14	33-55	RCR05G103K	A2A1R35	33-41	RCR05G333K
A2A1R15	32-101	RCR05G222K	A2A1R35	32-8	RCR05G333K
A2A1R15	33-58	RCR05G222K	A2A1R36	32-18	RCR05G151K
A2A1R16	32-22	RCR05G222K	A2A1R39	33-20	RCR05G680K
A2A1R16	33-69	RCR05G222K	A2A1R39	32-42	RCR05G750JS
A2A1R17	32-78	RCR05G222K	A2A1R4	32-14	RCR05G474K
A2A1R17	33-6	RCR05G103K	A2A1R4	33-45	RCR05G474K
A2A1R18	33-56	RCR05G222K	A2A1R4	32-61	RCR05G563K
A2A1R18	32-95	RCR05G222K	A2A1R40	33-40	RCR05G563K
A2A1R19	32-92	RCR05G103K	A2A1R40	32-109	3292L1-203
A2A1R19	33-3	RCR05G103K	A2A1R41	33-102	RT22C2L203
A2A1R2	32-60	T055-5-11K1F	A2A1R41	32-64	RCR05G103K
A2A1R2	33-88	T055-5-11K1F	A2A1R42	33-42	RCR05G103K
A2A1R20	32-91	RCR05G102K	A2A1R42	33-101	RT22C2L502
A2A1R20	33-64	RCR05G102K	A2A1R43	32-110	3292L1-502
A2A1R21	33-9	RCR05G561K	A2A1R43	33-79	RCR05G102K
A2A1R21	32-88	RCR05G561K	A2A1R44	32-62	RCR05G102K
A2A1R22	33-8	RCR05G561K	A2A1R44	33-5	RCR05G221K
A2A1R22	32-89	RCR05G561K	A2A1R45	32-66	RCR05G153K
A2A1R23	33-19	RCR05G102K	A2A1R5	32-66	RCR05G133JS
A2A1R23	32-80	RCR05G102K	A2A1R5	33-77	RCR05G133JS
A2A1R24	33-27	RCR05G472K	A2A1R5	32-66	RCR05G153K
A2A1R24	32-52	RCR05G472K	A2A1R6	33-39	RCR05G153JS
A2A1R25	33-28	RCR05G103K	A2A1R6	32-11	RCR05G153K
A2A1R25	32-56	RCR05G103K	A2A1R6	32-11	RCR05G153JS
A2A1R26	32-47	RCR05G222K	A2A1R6	32-11	RCR05G153K

REFERENCE DESIGNATION INDEX

REFERENCE DESIGNATION	FIG - ITEM	PART NUMBER	REFERENCE DESIGNATION	FIG - ITEM	PART NUMBER
A2A1R7	33-86	RCR05G472JS	A2C31	25-179	K05SK102M
A2A1R7	32-74	RCR05G472JS	A2C31	23-106	K05SK102M
A2A1R7	32-74	RCR05G472K	A2C32	23-104	2C067473X0101A3
A2A1R7	32-74	RCR05G472K	A2C32	25-109	2C067473X0101A3
A2A1R8	32-68	T055-5-11K1F	A2C33	23-100	K05SK102M
A2A1R8	33-90	T055-5-11K1F	A2C33	25-124	K05SK102M
A2A1R9	32-57	RCR05G474K	A2C34	23-107	2C067472X0101A
A2A1R9	33-31	RCR05G474K	A2C34	25-123	2C067472X0101A3
A2A1T1	32-114	A289	A2C35	25-125	2C067103X0101A3
A2A1T2	32-113	A289	A2C35	23-18	2C067103X0101A3
A2A1U1	32-44	MC1596G	A2C36	25-177	8131-050-651-104
A2A1U1	33-92	MC1596G			M
A2A1U2	32-40	U5B7716393	A2C36	23-97	8131-050-651-104
A2A1Y1.Y2	33-72	289-7179-010M70			M
A2A1Y1.Y2	33-72	289-7179-020M70	A2C37	23-99	150D475X0035R2
A2A1Y1.Y2	32-115	289-7179-010M70	A2C37	25-128	150D475X0035R2
A2CR2	25-15	1N914	A2C38	25-138	DM5E680J050WV
A2CR3	25-61	1N914	A2C38	23-98	DM5E680J050WV
A2CR4	25-60	1N914	A2C39	23-101	DM5E430J050WV
A2CR6	23-63	1N914	A2C39	25-136	DM5E430J050WV
A2CR6	25-141	1N914	A2C4	25-37	150D476X0020R2
A2CR7	25-142	1N914	A2C4	23-3	150D476X0020R2
A2CR7	23-62	1N914	A2C40	25-130	150D475X0035R2
A2CR8	25-122	1N914	A2C40	23-81	150D475X0035R2
A2CR8	23-59	1N914	A2C41	25-167	M39003-01-2135
A2CR9	25-71	1N914	A2C41	23-80	M39003-01-2135
A2CR9	23-54	1N914	A2C43	25-140	M39003-01-2044
A2C1	25-33	2C067103X0101A3	A2C43	23-65	M39003-01-2044
A2C1	23-47	2C067103X0101A3	A2C44	23-111	150D476X0020P2
A2C10	25-104	150D475X0035B2	A2C44	25-139	150D476X0020R2
A2C11	25-2	150D475X0035B2	A2C45	25-103	2C067473X0101A3
A2C12	25-9	2C067103X0101A3	A2C45	23-22	2C067473X0101A3
A2C13	25-52	2C067103X0101A3	A2C46	23-10	8131-100C0G332K
A2C14	25-47	2C067103X0101A3	A2C46	25-68	8131-100C0G332K
A2C15	25-55	DM5F331J050WV	A2C47	25-169	2C067103X0101A3
A2C16	25-53	DM5F331J050WV	A2C47	23-77	2C067103X0101A3
A2C17	25-41	263C025681X5101B	A2C5	25-57	150D475X0035R2
A2C18	25-8	2C067103X0101A3	A2C6	25-54	2C067103X0101A3
A2C19	25-108	150D475X0035B2	A2C7	25-16	2C067223X0101A3
A2C2	25-32	8131-050-651-104	A2C8	25-51	2C067103X0101A3
		M	A2C9	25-19	150D475X0035R2
A2C2	23-37	8131-050-651-104	A2L1	23-78	MS90539-15
		M	A2L1	25-135	MS90539-15
A2C20	25-78	150D475X0035B2	A2Q1	25-21	2N2222A
A2C21	25-73	M39003-01-2022	A2Q10	23-31	2N2222A
A2C22	23-34	M39003-01-2111	A2Q10	25-94	2N2222A
A2C22	25-30	M39003-01-2111	A2Q11	23-94	2N2222A
A2C23	25-93	M39003-01-2111	A2Q11	25-83	2N2222A
A2C23	23-28	M39003-01-2111	A2Q12	25-87	2N2222A
A2C24	25-92	M39003-01-2111	A2Q12	23-88	2N2222A
A2C24	23-93	M39003-01-2111	A2Q13	25-155	2N2222A
A2C25	25-153	2C067472X0101A3	A2Q13	23-14	2N2222A
A2C25	23-41	2C067472X0101A3	A2Q14	23-21	2N2222A
A2C26	23-19	2C067103X0101A3	A2Q14	25-157	2N2222A
A2C26	25-154	2C067103X0101A3	A2Q15	25-178	2N2608
A2C27	23-15	M39003-01-2065	A2Q15	23-12	2N2608
A2C27	25-158	M39003-01-2065	A2Q16	25-151	2N2222A
A2C28	25-166	150D475X0035B2	A2Q16	23-70	2N2222A
A2C28	23-46	150D475X0035B2	A2Q17	25-152	2N2222A
A2C29	25-165	150D475X0035B2	A2Q17	23-66	2N2222A
A2C29	23-16	150D475X0035B2	A2Q18	23-95	2N2222A
A2C30	25-132	2C067103X0101A3	A2Q18	25-82	2N2222A
A2C30	23-109	2C067103X0101A3	A2Q19	23-60	2N2222A



## REFERENCE DESIGNATION INDEX

REFERENCE DESIGNATION	FIG - ITEM	PART NUMBER	REFERENCE DESIGNATION	FIG - ITEM	PART NUMBER
A2Q19	25-150	2N2222A	A2R43	25-65	RCR07G222KS
A2Q2	25-22	2N2222A	A2R44	23-42	RCR07G123KS
A2Q20	23-49	2N2222A	A2R44	25-23	RCR07G123KS
A2Q20	25-91	2N2222A	A2R45	25-27	RCR07G102KS
A2Q3	25-111	2N2907A	A2R45	23-39	RCR07G102KS
A2Q4	25-10	2N2907A	A2R48	23-40	RCR07G103KS
A2Q5	25-67	2N2222A	A2R48	25-28	RCR07G103KS
A2Q6	25-66	2N2222A	A2R49	25-96	RCR07G222KS
A2Q6	23-4	2N2222A	A2R49	23-36	RCR07G222KS
A2Q7	23-44	2N2222A	A2R5	25-114	RCR07G102KS
A2Q7	25-29	2N2222A	A2R50	23-35	RCR07G222KS
A2Q8	25-31	2N2222A	A2R50	25-97	RCR07G222KS
A2Q8	23-38	2N2222A	A2R51	25-25	RCR07G913JS
A2Q9	25-95	2N2222A	A2R51	23-23	RCR07G913JS
A2Q9	23-25	2N2222A	A2R52	25-26	RCR07G123KS
A2R1	23-52	RW69V151	A2R52	23-24	RCR07G123KS
A2R1	25-36	RW69V151	A2R53	25-101	RCR07G102KS
A2R10	25-13	RCR07G511JS	A2R53	23-30	RCR07G102KS
A2R100	25-18	RCR07G222KS	A2R54	25-102	RCR07G103KS
A2R100	23-50	RCR07G222KS	A2R54	23-29	RCR07G103KS
A2R101	25-89	RCR07G222KS	A2R55	23-33	RCR07G222KS
A2R101	23-48	RCR07G222KS	A2R55	25-99	RCR07G222KS
A2R102	25-135	RCR07G101KS	A2R56	25-98	RCR07G222KS
A2R102	25-135	RCR07G101KS	A2R56	23-32	RCR07G222KS
A2R102	23-78	RCR07G101KS	A2R57	25-A0	RCR07G913JS
A2R102	23-78	RCR07G101KS	A2R57	23-82	RCR07G913JS
A2R11	25-20	T055-31-6K1F	A2R58	25-81	RCR07G123KS
A2R12	25-39	RN55D5761F	A2R58	23-83	RCR07G123KS
A2R13	25-107	RCR07G472KS	A2R59	25-163	RCR07G682KS
A2R14	25-75	RCR07G474KS	A2R59	23-26	RCR07G682KS
A2R15	25-76	RCR07G104KS	A2R6	25-14	RCR07G273KS
A2R16	25-46	RCR07G511JS	A2R60	25-161	RCR07G102KS
A2R17	25-106	RCR07G101KS	A2R60	23-87	RCR07G102KS
A2R18	25-45	RCR07G151KS	A2R61	25-79	RCR07G103KS
A2R19	25-17	RCR07G513JS	A2R61	23-86	RCR07G103KS
A2R2	25-3	RCR07G511JS	A2R62	25-86	RCR07G222KS
A2R20	25-44	RCR07G103KS	A2R62	23-89	RCR07G222KS
A2R21	25-50	RCR07G753JS	A2R63	25-85	RCR07G222KS
A2R22	25-48	RCR07G154KS	A2R63	23-90	RCR07G222KS
A2R23	25-43	RCR07G154KS	A2R64	25-159	RCR07G332KS
A2R24	25-7	RCR07G332KS	A2R64	23-11	RCR07G332KS
A2R25	25-42	RCR07G563KS	A2R65	25-162	RCR07G103KS
A2R26	25-40	RCR07G511JS	A2R65	23-9	RCR07G103KS
A2R27	25-119	RT22C2L103	A2R66	25-156	RCR07G222KS
A2R28	25-49	T055-31-6K1F	A2R66	23-8	RCR07G222KS
A2R29	25-35	T055-5-11K1F	A2R67	23-51	RCR07G222KS
A2R3	25-4	RCR07G513JS	A2R67	25-84	RCR07G222KS
A2R30	25-56	RN60C5622F	A2R68	25-160	RCR07G562KS
A2R31	25-105	RCR07G472KS	A2R68	23-17	RCR07G562KS
A2R32	25-74	RCR07G474KS	A2R69	25-172	RCR07G103KS
A2R33	25-77	RCR07G104KS	A2R69	23-13	RCR07G103KS
A2R34	25-115	RCR07G103KS	A2R7	25-11	RCR07G273KS
A2R35	25-59	RCR07G473KS	A2R70	25-118	RT22C2L502
A2R36	25-116	RCR07G473KS	A2R70	23-7	RT22C2L502
A2R37	25-70	RCR07G101KS	A2R71	25-121	RCR07G103KS
A2R38	25-112	RCR07G102KS	A2R71	23-110	RCR07G103KS
A2R39	23-55	RCR07G472KS	A2R72	23-64	RCR07G274KS
A2R39	25-180	RCR07G472KS	A2R72	25-175	RCR07G274KS
A2R4	25-113	RCR07G682KS	A2R73	23-72	RCR07G151KS
A2R40	25-64	RCR07G222KS	A2R73	25-173	RCR07G151KS
A2R41	25-62	RCR07G682KS	A2R74	25-176	RCR07G682KS
A2R42	25-63	RCR07G472KS	A2R74	23-108	RCR07G682KS
A2R42	23-58	RCR07G472KS	A2R75	25-174	RCR07G202JS

REFERENCE DESIGNATION INDEX

REFERENCE DESIGNATION	FIG - ITEM	PART NUMBER	REFERENCE DESIGNATION	FIG - ITEM	PART NUMBER
A2R75	23-71	RCR07G202JS	A3	1-22	77A-2952-001
A2R76	23-102	RCR07G202JS	A3	22-	77A-2952-001
A2R76	25-181	RCR07G202JS	A3CR1	22-46	1N4003
A2R77	25-120	RCR07G202JS	A3CR10	22-136	1N459
A2R77	23-103	RCR07G202JS	A3CR11	22-135	1N459
A2R78	25-126	RCR07G151KS	A3CR12	22-126	1N753A
A2R78	23-20	RCR07G151KS	A3CR13	22-206	1N459
A2R79	25-127	RCR07G681JS	A3CR14	22-142	1N459
A2R79	23-73	RCR07G681JS	A3CR15	22-158	1N4733
A2R8	25-5	RCR07G563KS	A3CR3	22-43	1N5767
A2R80	25-137	RCR07G750JS	A3CR4	22-29	1N5767
A2R80	23-96	RCR07G750JS	A3CR5	22-22	1N5767
A2R82	25-131	RCR07G182KS	A3CR6	22-16	1N5767
A2R82	23-85	RCR07G182KS	A3CR7	22-202	1N914
A2R83	25-38	RCR07G511JS	A3CR8	22-114	1N914
A2R83	23-45	RCR07G511JS	A3CR9	22-113	1N751A
A2R84	23-43	RCR07G913JS	A3C1	22-38	D71F152J0
A2R84	25-24	RCR07G913JS	A3C10	22-63	2C067103X0101A3
A2R85	25-168	RCR07G473KS	A3C11	22-69	M39003-01-2047
A2R85	23-74	RCR07G473KS	A3C12	22-55	8131-050-651-104
A2R86	23-69	RCR07G124JS			M
A2R86	25-171	RCR07G124KS	A3C13	22-27	2C067472X0101A3
A2R87	25-170	RCR07G103KS	A3C14	22-144	8131-050-651-104
A2R87	23-75	RCR07G103KS			M
A2R88	25-164	RCR07G153KS	A3C15	22-24	2C067472X0101A3
A2R88	23-68	RCR07G153JS	A3C16	22-65	8131-050-651-104
A2R89	25-144	RN60N6650F			M
A2R89	23-76	RN60N6650F	A3C17	22-148	2C067472X0101A3
A2R9	25-12	RCR07G133JS	A3C18	22-21	2C067103X0101A3
A2R90	23-67	RN60N6040F	A3C19	22-20	8131-050-651-104
A2R90	25-143	RN60N6040F			M
A2R91	23-112	T055-8-25K1F	A3C2	22-35	8131-050-651-104
A2R91	23-112	T055-8661-1F			M
A2R91	23-112	T055-9531-1F	A3C20	22-68	8131-050-651-104
A2R91	23-112	T055-9-09K1F			M
A2R91	25-148	T055-9-09K1F	A3C21	22-152	8131-050-651-104
A2R91	23-112	T055-9-09K1F			M
A2R92	25-146	RCR07G223KS	A3C22	22-18	2C067472X0101A3
A2R92	23-113	RCR07G223KS	A3C23	22-71	8131-050-651-104
A2R93	25-90	RCR07G222KS			M
A2R93	23-91	RCR07G222KS	A3C24	22-74	2C067103X0101A3
A2R94	25-88	RCR07G472KS	A3C25	22-76	8131-050-651-104
A2R94	23-92	RCR07G472KS			M
A2R95	25-58	RCR07G223KS	A3C26	22-9	8131-050-651-104
A2R95	23-2	RCR07G223KS			M
A2R96	25-69	RCR07G104KS	A3C27	22-15	2C067472X0101A3
A2R96	23-53	RCR07G104KS	A3C28	22-157	M39003-01-2111
A2R97	25-72	RCR07G105KS	A3C29	22-11	K05SK102M
A2R97	23-56	RCR07G105KS	A3C3	22-50	2C067472X0101A3
A2R98	25-145	RCR07G103KS	A3C30	22-77	8131-050-651-104
A2R98	23-6	RT22C2L103			M
A2R99	23-61	RCR07G103KS	A3C31	22-82	8131-050-651-104
A2R99	25-147	RCR07G103KS			M
A2T1	23-84	SP67	A3C32	22-159	K05SK102M
A2T1	25-149	SP67	A3C33	22-90	8131-050-651-104
A2U1	25-6	MC1435G			M
A2U2	25-110	RC741T	A3C34	22-167	8131-050-651-104
A2U3	23-105	MC1435G			M
A2U3	25-129	MC1435G	A3C35	22-189	M39003-01-2067
A2U4	25-133	J5B7716393	A3C36	22-186	8131-050-651-104
A2U4	23-79	J5B7716393			M
A2VR1	25-34	1N4733	A3C37	22-105	2C067472X0101A3
A2VR1	23-57	1N4733	A3C38	22-101	8131-050-651-104
A2VR5	25-100	1N4741			M
A2VR5	23-27	1N4741			M

## REFERENCE DESIGNATION INDEX

REFERENCE DESIGNATION	FIG - ITEM	PART NUMBER	REFERENCE DESIGNATION	FIG - ITEM	PART NUMBER
A3C39	22-155	CM06FD821 J03	A3CA8	22-133	8131-050-651-104 M
A3C4	22-45	2C067103X0101A3	A3C9	22-31	8131-050-651-104 M
A3C40	22-97	8131-050-651-104 M	A3L1	22-53	MS90537-49
A3C41	22-228	K05SK102M	A3L10	22-212	MS90539-15
A3C42	22-95	2C067103X0101A3	A3L11	22-170	MS90539-15
A3C43	22-185	8131-050-651-104 M	A3L2	22-61	MS90537-49
A3C44	22-183	CM06FD821 J03	A3L3	22-62	MS90537-49
A3C45	22-182	2C067332X0101A3	A3L4	22-23	MS90537-49
A3C46	22-232	2C067332X0101A3	A3L5	22-81	MS90537-49
A3C47	22-180	8131-050-651-104 M	A3L6	22-17	MS90537-49
A3C48	22-177	2C067103X0101A3	A3L7	22-44	MS90537-49
A3C49	22-173	K05SK102M	A3L8	22-184	MS90537-41
A3C5	22-52	439003-01-2047	A3L9	22-230	MS90540-08
A3C50	22-178	2C067223X0101A3	A3P1	22-241	141-1002-0002
A3C51	22-237	K05SK102M	A3P3	22-242	141-1002-0002
A3C52	22-236	2C067472X0101A3	A3P4	22-243	141-1002-0002
A3C53	22-239	2C067103X0101A3	A3Q1	22-47	2N2222A
A3C54	22-86	439003-01-2015	A3Q10	22-128	2N2905
A3C55	22-168	439003-01-2047	A3Q11	22-104	2N2222A
A3C56	22-88	DM5E430J050WV	A3Q12	22-229	3N141
A3C57	22-89	DM5E680J050WV	A3Q13	22-13	2N2222A
A3C58	22-2	439003-01-2047	A3Q14	22-10	2N2222A
A3C59	22-147	K05SK102M	A3Q15	22-165	2N2222A
A3C6	22-51	8131-050-651-104 M	A3Q16	22-111	2N2222A
A3C60	22-195	8131-050-651-104 M	A3Q2	22-26	2N2222A
A3C61	22-225	8131-050-651-104 M	A3Q3	22-19	2N2222A
A3C62	22-194	8131-050-651-104 M	A3Q4	22-109	2N2222A
A3C63	22-208	8131-050-651-104 M	A3Q5	22-191	2N2222A
A3C64	22-196	439003-01-2044	A3Q6	22-211	2N2222A
A3C65	22-205	K05SK102M	A3Q7	22-115	2N2907A
A3C66	22-216	439003-01-2044	A3Q8	22-210	2N2222A
A3C67	22-215	150D475X0035B2	A3Q9	22-129	2N2222A
A3C68	22-209	8131-050-651-104 M	A3R1	22-28	RCR07G102KS
A3C69	22-119	2C067103X0101A3	A3R10	22-30	RCR07G470KS
A3C7	22-60	2C067472X0101A3	A3R100	22-238	RCR07G6A1KS
A3C70	22-131	DM5F331J050WV	A3R101	22-235	RCR07G151KS
A3C71	22-138	2C067473X0101A3	A3R102	22-169	RCR07G182KS
A3C72	22-143	150D105X0035A2	A3R103	22-91	T055-75-1F
A3C73	22-199	2C067103X0101A3	A3R105	22-94	55N2000F
A3C74	22-218	2C067103X0101A3	A3R106	22-121	RCR07G103KS
A3C75	22-32	2C067103X0101A3	A3R107	22-116	RCR07G183KS
A3C76	22-33	2C067103X0101A3	A3R108	22-200	RCR07G100KS
A3C77	22-125	8131-050-651-104 M	A3R11	22-64	T055-4021-1F
A3C78	22-207	2C067473X0101A3	A3R12	3-26	RN55D6491F
A3C8	22-57	8131-050-651-104 M	A3R12	22-140	RCR07G153KS
A3C80	22-1	439003-01-2056	A3R13	22-139	RCR07G103KS
A3C81	22-83	8131-050-651-104 M	A3R14	22-145	55N2670F
A3C84	22-96	2C067103X0101A3	A3R15	22-25	T055-86R6-1F
A3C85	22-93	439003-01-2005	A3R16	22-66	RCR07G122KS
A3C86	22-3	2C067103X0101A3	A3R17	22-70	T055-4021-1F
A3C87	22-134	8131-050-651-104 M	A3R18	22-146	RCR07G470KS
			A3R19	22-150	RCR07G153KS
			A3R2	22-42	RCR07G272KS
			A3R20	22-151	RCR07G103KS
			A3R21	22-149	55N2670F
			A3R22	22-72	T055-86R6-1F
			A3R22	22-72	997F18
			A3R23	22-73	RCR07G122KS
			A3R24	22-75	T055-4021-1F
			A3R25	22-154	RCR07G470KS
			A3R26	22-153	RCR07G470KS
			A3R27	22-106	RCR07G153KS

REFERENCE DESIGNATION INDEX

REFERENCE DESIGNATION	FIG - ITEM	PART NUMBER	REFERENCE DESIGNATION	FIG - ITEM	PART NUMBER
A3R28	22-107	RCR07G103KS	A3R83	22-39	RCR07G222KS
A3R29	22-100	T055-78R7-1F	A3R84	22-130	RCR20G470KS
A3R3	22-49	T055-11800-1F	A3R85	22-41	RCR07G562KS
A3R30	22-226	RCR07G122KS	A3R86	22-201	RCR07G272KS
A3R31	22-98	RCR07G682KS	A3R9	22-54	RCR07G122KS
A3R32	22-102	RCR07G101KS	A3R90	22-141	RCR07G224KS
A3R33	22-227	RCR07G223KS	A3R91	22-84	RCR07G102KS
A3R34	22-231	RCR07G331KS	A3R92	22-179	RT22C2P203
A3R35	22-188	RCR07G334KS	A3R93	22-175	RCR07G472KS
A3R36	22-181	RCR07G103KS	A3R94	22-174	RCR07G474KS
A3R37	22-187	RCR07G272KS	A3R95	22-176	RCR07G682KS
A3R38	22-156	RCR07G153KS	A3R96	22-92	RCR07G151KS
A3R39	22-14	RCR07G103KS	A3R97	22-233	T055-2000-1F
A3R4	22-36	RCR07G473KS	A3R98	22-171	T055-2000-1F
A3R40	22-12	T055-6490-1F	A3R99	22-234	T055-2000-1F
A3R41	22-79	T055-61-9-1F	A3T1	22-48	A264
A3R42	22-80	RCR07G122KS	A3T2	22-99	A249
A3R43	22-164	RCR07G151KS	A3T3	22-5	A265
A3R44	22-162	RCR07G153KS	A3T4	22-198	780-3065-001
A3R45	22-160	RCR07G103KS	A3T5	22-78	SP67
A3R46	22-161	55D8060F	A3U1	22-132	U3F770931
A3R47	22-8	T055-61-9-1F	A3U2	22-172	MC1435G
A3R48	22-7	RCR07G122KS	A3U3	22-85	U5B7716393
A3R49	22-163	RCR07G472KS	A3VR2	22-67	1N746A
A3R5	22-37	RCR07G333KS	A4	1-21	77A-2951-003
A3R50	22-6	RCR07G272KS	A4	1-21	77A-2951-001
A3R51	22-166	RCR07G470KS	A4	1-21	77A-2951-004
A3R52	22-87	RCR07G471KS	A4	21-	77A-2951-001
A3R53	22-4	RCR07G102KS	A4	21-	77A-2951-004
A3R54	22-108	RCR07G153KS	A4	21-	77A-2951-003
A3R55	22-110	RCR07G103KS	A4CR1	21-49	1N4003
A3R56	22-222	T055-1-78K1F	A4CR10	21-120	1N459
A3R57	22-223	RT22C2P101	A4CR11	21-142	1N459
A3R58	22-224	RCR07G270KS	A4CR12	21-143	1N459
A3R59	22-103	RCR07G152KS	A4CR14	21-212	1N459
A3R6	22-58	55D2670F	A4CR2	21-139	1N5767
A3R60	22-197	RCR07G101KS	A4CR4	21-150	1N5767
A3R61	22-192	T055-78R7-1F	A4CR5	21-32	1N5767
A3R61	22-192	55D45R3F	A4CR6	21-25	1N5767
A3R62	22-193	RCR07G122KS	A4CR7	21-204	1N914
A3R63	22-204	RCR07G473KS	A4CR8	21-119	1N914
A3R64	22-203	RCR07G472KS	A4C1	21-44	8131-050-651-104 M
A3R65	22-213	RCR07G103KS	A4C10	21-66	2C067103X0101A3
A3R66	22-190	RCR07G122KS	A4C11	21-36	2C067472X0101A3
A3R66	22-190	RCR07G272KS	A4C12	21-39	8131-050-651-104 M
A3R67	22-217	RCR07G471KS	A4C13	21-37	8131-050-651-104 M
A3R68	22-112	RCR07G105KS	A4C14	21-152	8131-050-651-104 M
A3R69	22-220	RCR07G104KS	A4C15	21-34	2C067472X0101A3
A3R7	22-56	RT22C2P101	A4C16	21-72	2C067103X0101A3
A3R70	22-221	RCR07G103KS	A4C17	21-31	2C067472X0101A3
A3R71	22-214	RCR07G182KS	A4C18	21-30	8131-050-651-104 M
A3R72	22-219	RCR07G392KS	A4C19	21-74	8131-050-651-104 M
A3R73	22-117	RCR07G223KS	A4C2	21-48	D71F152JO
A3R74	22-118	RCR07G223KS	A4C20	21-27	2C067472X0101A3
A3R75	22-124	RCR07G152KS	A4C21	21-159	8131-050-651-104 M
A3R76	22-120	RCR07G223KS	A4C22	21-76	2C067103X0101A3
A3R77	22-122	RCR07G563KS			
A3R78	22-123	RCR07G223KS			
A3R79	22-127	42TF29			
A3R8	22-59	55D32R4F			
A3R80	22-34	RCR07G222KS			
A3R81	22-137	RCR07G222KS			
A3R82	22-40	RCR07G271KS			

## REFERENCE DESIGNATION INDEX

REFERENCE DESIGNATION	FIG - ITEM	PART NUMBER	REFERENCE DESIGNATION	FIG - ITEM	PART NUMBER
A4C23	21-23	A131-050-651-104 M	A4C62	21-177	2C067332X0101A3
A4C24	21-71	8131-050-651-104 M	A4C63	21-92	150D105X0035A2
A4C25	21-19	8131-050-651-104 M	A4C64	21-178	8131-050-651-104 M
A4C26	21-24	2C067472X0101A3	A4C65	21-199	2C067103X0101A3
A4C27	21-165	M39003-01-2111	A4C66	21-209	8131-050-651-104 M
A4C28	21-20	K05SK102M	A4C67	21-198	M39003-01-2044
A4C29	21-78	8131-050-651-104 M	A4C68	21-206	K05SK102M
A4C3	21-50	2C067103X0101A3	A4C69	21-225	M39003-01-2044
A4C30	21-82	8131-050-651-104 M	A4C7	21-53	8131-050-651-104 M
A4C31	21-15	K05SK102M	A4C70	21-224	M39003-01-2015
A4C32	21-9	8131-050-651-104 M	A4C71	21-117	M39003-01-2117
A4C33	21-170	8131-050-651-104 M	A4C71	21-117	M39003-01-2039
A4C34	21-239	M39003-01-2067	A4C71	21-117	M39003-01-2039
A4C35	21-103	8131-050-651-104 M	A4C71	21-117	150D156X9020B2
A4C36	21-107	8131-050-651-104 M	A4C71	21-117	150D105X0035A2
A4C37	21-110	2C067472X0101A3	A4C71	21-117	M39003-01-2039
A4C38	21-106	8131-050-651-104 M	A4C72	21-145	CK05BX683K
A4C39	21-98	D71F821J0	A4C72	21-145	2C067473X0101A3
A4C4	21-56	2C067472X0101A3	A4C73	21-226	2C067103X0101A3
A4C40	21-95	K05SK102M	A4C74	21-79	8131-050-651-104 M
A4C41	21-172	2C067103X0101A3	A4C74	21-79	2C067103X0101A3
A4C42	21-101	8131-050-651-104 M	A4C75	21-84	M39003-01-2056
A4C43	21-171	2C067332X0101A3	A4C76	21-41	2C067103X0101A3
A4C44	21-7	2C067332X0101A3	A4C77	21-42	2C067103X0101A3
A4C45	21-8	8131-050-651-104 M	A4C78	21-125	2C067103X0101A3
A4C46	21-93	D71F621J0	A4C79	21-130	DM5F331J050WV
A4C47	21-87	8131-050-651-104 M	A4C8	21-60	8131-050-651-104 M
A4C48	21-10	2C067103X0101A3	A4C80	21-211	8131-050-651-104 M
A4C49	21-4	2C067103X0101A3	A4C81	21-217	8131-050-651-104 M
A4C5	21-55	M39003-01-2029	A4C82	21-215	2C067473X0101A3
A4C50	21-114	K05SK102M	A4C83	21-205	8131-050-651-104 M
A4C51	21-238	8131-050-651-104 M	A4C84	21-62	2C067472X0101A3
A4C52	21-196	8131-050-651-104 M	A4C85	21-140	8131-050-651-104 M
A4C53	21-194	8131-050-651-104 M	A4C86	21-141	8131-050-651-104 M
A4C54	21-189	2C067472X0101A3	A4C87	21-134	K05SK102M
A4C55	21-233	8131-050-651-104 M	A4C9	21-69	M39003-01-2047
A4C56	21-184	8131-050-651-104 M	A4L1	21-57	MS90539-15
A4C57	21-183	M39003-01-2047	A4L10	21-195	MS90539-15
A4C58	21-243	8131-050-651-104 M	A4L11	21-173	MS90540-08
A4C59	21-244	DM5F101J050WV	A4L13	21-120	MS90539-15
A4C6	21-61	8131-050-651-104 M	A4L2	21-65	MS90539-15
A4C60	21-241	D71F821J0	A4L3	21-81	MS90539-15
A4C61	21-246	2C067332X0101A3	A4L4	21-64	MS90539-15
			A4L5	21-33	MS90539-15
			A4L6	21-26	MS90539-15
			A4L7	21-51	MS90539-15
			A4L8	21-242	A266
			A4L9	21-99	MS90537-41
			A4P1	21-248	141-1002-0002
			A4P3	21-249	141-1002-0002
			A4P4	21-250	141-1002-0002
			A4P5	21-251	141-1002-0002
			A4Q1	21-47	2N2222A
			A4Q10	21-113	2N2222A

## REFERENCE DESIGNATION INDEX

REFERENCE DESIGNATION	FIG - ITEM	PART NUMBER	REFERENCE DESIGNATION	FIG - ITEM	PART NUMBER
A4Q10	21-113	2N2222A	A4R36	21-169	RCR07G103KS
A4Q10	21-113	2N2905	A4R37	21-168	55D8060F
A4Q11	21-190	2N2222A	A4R38	21-17	T055-61-9-1F
A4Q12	21-187	2N2222A	A4R39	21-16	RCR07G122KS
A4Q13	21-220	2N2222A	A4R4	21-45	RCR07G473KS
A4Q14	21-213	2N2222A	A4R40	21-14	RCR07G472KS
A4Q15	21-121	2N2907A	A4R41	21-85	RCR07G272KS
A4Q16	21-228	2N2222A	A4R42	21-11	RCR07G471KS
A4Q17	21-133	2N2222A	A4R43	21-12	RCR07G470KS
A4Q18	21-132	2N2905	A4R44	21-88	RCR07G102JS
A4Q2	21-151	2N2222A	A4R45	21-105	T055-78R7-1F
A4Q3	21-29	2N2222A	A4R46	21-108	RCR07G122KS
A4Q4	21-109	2N2222A	A4R47	21-161	RCR07G101KS
A4Q5	21-94	3N141	A4R48	21-100	RCR07G682KS
A4Q6	21-22	2N2222A	A4R49	21-175	RCR07G223KS
A4Q7	21-18	2N2222A	A4R5	21-46	RCR07G333KS
A4Q8	21-13	2N2222A	A4R50	21-174	RCR07G331KS
A4Q9	21-5	2N2222A	A4R51	21-97	RCR07G272KS
A4RT22	21-75	997F18	A4R52	21-96	RCR07G334KS
A4RT99	21-129	42TF29	A4R53	21-89	RCR07G103KS
A4R1	21-38	RCR07G102JS	A4R54	21-6	RCR07G153KS
A4R10	21-146	RCR07G470KS	A4R55	21-1	RCR07G472KS
A4R100	21-126	RCR07G223KS	A4R56	21-3	RCR07G101KS
A4R101	21-127	RCR07G152KS	A4R57	21-2	RCR07G471KS
A4R102	21-144	RCR07G222KS	A4R58	21-155	RCR07G153KS
A4R102	21-144	RCR07G223KS	A4R59	21-115	RCR07G103KS
A4R103	21-43	RCR07G222KS	A4R6	21-59	RT22C2P101
A4R104	21-136	RCR07G271KS	A4R60	21-231	T055-1-7AK1F
A4R105	21-135	RCR07G222KS	A4R61	21-232	RT22C2P101
A4R106	21-131	RCR20G470KS	A4R62	21-234	RCR07G470KS
A4R108	21-137	RCR07G562KS	A4R62	21-234	RCR07G270KS
A4R109	21-208	RT22C2P202	A4R63	21-235	RCR07G152KS
A4R11	21-149	RCR07G153KS	A4R64	21-197	RCR07G101KS
A4R110	21-202	RCR07G332KS	A4R65	21-193	55D45R3F
A4R110	21-202	RCR07G222KS	A4R66	21-192	RCR07G122KS
A4R111	21-210	RCR07G102JS	A4R67	21-186	RCR07G183KS
A4R112	21-201	RCR07G100KS	A4R68	21-185	RCR07G103KS
A4R12	21-148	RCR07G103KS	A4R69	21-237	RCR07G680KS
A4R13	21-67	T055-4021-1F	A4R7	21-63	RCR07G150KS
A4R14	21-154	55D2670F	A4R7	21-63	55D32R4F
A4R15	21-35	T055-86R6-1F	A4R70	21-236	RCR07G102JS
A4R16	21-68	RCR07G122KS	A4R71	21-188	RCR07G121JS
A4R17	21-153	RCR07G470KS	A4R72	21-176	RCR07G331KS
A4R18	21-73	T055-4021-1F	A4R73	21-182	RCR07G680KS
A4R19	21-157	RCR07G153KS	A4R74	21-179	RCR07G562KS
A4R2	21-138	RCR07G272KS	A4R75	21-181	RCR07G472KS
A4R20	21-158	RCR07G103KS	A4R76	21-180	RCR07G183KS
A4R21	21-156	55D2670F	A4R77	21-247	RCR07G392KS
A4R22	21-75	T055-86R6-1F	A4R78	21-90	RCR07G392KS
A4R23	21-28	RCR07G122KS	A4R79	21-91	RCR07G472KS
A4R24	21-162	RCR07G470KS	A4R8	21-58	RCR07G122KS
A4R25	21-77	T055-4021-1F	A4R80	21-240	RCR07G182KS
A4R26	21-180	RCR07G470KS	A4R81	21-229	RCR07G104KS
A4R27	21-111	RCR07G153KS	A4R82	21-230	RCR07G103KS
A4R28	21-112	RCR07G103KS	A4R83	21-203	RCR07G472KS
A4R29	21-164	RCR07G153KS	A4R84	21-207	RCR07G473KS
A4R3	21-52	T055-11800-1F	A4R85	21-222	RCR07G471KS
A4R30	21-102	RCR07G103KS	A4R86	21-221	RCR07G103KS
A4R31	21-21	T055-61-9-1F	A4R87	21-191	RCR07G272KS
A4R32	21-80	RCR07G122KS	A4R87	21-191	RCR07G392KS
A4R33	21-163	T055-6490-1F	A4R88	21-116	RCR07G105KS
A4R34	21-167	RCR07G151KS	A4R88	21-116	RCR07G155KS
A4R35	21-166	RCR07G153KS	A4R88	21-116	RCR07G105KS

## REFERENCE DESIGNATION INDEX

REFERENCE DESIGNATION	FIG - ITEM	PART NUMBER	REFERENCE DESIGNATION	FIG - ITEM	PART NUMBER
A4R88	21-116	RCR07G185KS	A5A1C30	19-205	D71F152J0
A4R88	21-116	RCR07G105KS	A5A1C31	19-207	D71F152J0
A4R89	21-223	RCR07G182KS	A5A1C32	19-63	2C067103X0101A3
A4R9	21-40	55D2670F	A5A1C33	19-113	8131-050-651-104 M
A4R90	21-227	RCR07G392KS	A5A1C34	19-9	2C067103X0101A3
A4R91	21-123	RCR07G153KS	A5A1C35	19-115	2C067103X0101A3
A4R92	21-122	RCR07G223KS	A5A1C36	19-116	2C067103X0101A3
A4R93	21-124	RCR07G223KS	A5A1C37	19-6	M39003-01-2029
A4R94	21-147	RCR07G224KS	A5A1C47	19-148	K05SK102M
A4R95	21-83	RCR07G100KS	A5A1C48	19-149	2C067103X0101A3
A4R95	21-83	RCR07G102JS	A5A1C49	19-161	2C067103X0101A3
A4R96	21-214	RCR07G223KS	A5A1C50	19-158	DM5E240D050WV
A4R97	21-218	RCR07G103KS	A5A1C51	19-162	DM5E240D050WV
A4R98	21-219	RCR07G563KS	A5A1C52	19-160	2C067103X0101A3
A4T1	21-54	A264	A5A1C53	19-163	2C067103X0101A3
A4T2	21-86	A265	A5A1C54	19-166	2C067103X0101A3
A4T3	21-104	A249	A5A1C55	19-175	8131-050-651-104 M
A4T4	21-200	780-3065-001	A5A1C56	19-146	K05SK102M
A4U1	21-128	J3F770931	A5A1C57	19-194	2C067103X0101A3
A4U2	21-245	J5E7754393	A5A1C58	19-192	2C067103X0101A3
A4VR13	21-216	1N753A	A5A1C59	19-154	DM5E270J050WV
A4VR3	21-70	1N746A	A5A1C60	19-171	2C067103X0101A3
A4VR9	21-118	1N751A	A5A1C61	19-170	DM5C180D050WV
A5A1	1-19	797-3571-007	A5A1C62	19-168	2C067103X0101A3
A5A1	1-19	797-3571-001	A5A1C63	19-174	2C067103X0101A3
A5A1	1-19	797-3571-011	A5A1C64	19-145	K05SK102M
A5A1	1-19	797-3571-010	A5A1C65	19-201	2C067103X0101A3
A5A1	1-19	797-3571-012	A5A1C66	19-197	2C067103X0101A3
A5A1	19-	797-3571-006	A5A1C67	19-195	DM5E270J050WV
A5A1	19-	797-3571-012	A5A1C68	19-185	2C067103X0101A3
A5A1	19-	797-3571-010	A5A1C69	19-182	DM5C180D050WV
A5A1	19-	797-3571-001	A5A1C70	19-178	2C067103X0101A3
A5A1	19-	797-3571-007	A5A1C71	19-181	2C067103X0101A3
A5A1	19-	797-3571-011	A5A1C72	19-18	8131-050-651-104 M
A5A1CR10	19-59	1N459	A5A1C73	19-67	K05SK102M
A5A1CR11	19-140	1N459	A5A1C74	19-76	2C067103X0101A3
A5A1CR12	19-139	1N459	A5A1C75	19-73	2C067103X0101A3
A5A1CR13	19-60	1N459	A5A1C76	19-72	DM5E270J050WV
A5A1CR14	19-213	1N459	A5A1C77	19-84	2C067103X0101A3
A5A1CR15	19-142	1N459	A5A1C78	19-85	DM5C180D050WV
A5A1CR16	19-134	1N459	A5A1C79	19-97	2C067103X0101A3
A5A1CR17	19-22	1N459	A5A1C80	19-86	2C067103X0101A3
A5A1CR18	19-23	1N459	A5A1C81	19-90	2C067103X0101A3
A5A1CR19	19-183	1N459	A5A1C82	19-88	2C067103X0101A3
A5A1CR9	19-125	1N459	A5A1C83	19-30	2C067103X0101A3
A5A1C11	19-126	2C067103X0101A3	A5A1C84	19-28	8131-050-651-104 M
A5A1C12	19-216	2C067103X0101A3	A5A1C85	19-107	2C067103X0101A3
A5A1C13	19-138	2C067103X0101A3	A5A1C86	19-15	2C067103X0101A3
A5A1C14	19-127	2C067103X0101A3	A5A1C87	19-17	2C067103X0101A3
A5A1C15	19-136	2C067103X0101A3	A5A1C88	19-41	2C067103X0101A3
A5A1C16	19-215	2C067103X0101A3	A5A1C89	19-37	2C067103X0101A3
A5A1C17	19-123	2C067103X0101A3	A5A1C90	19-80	2C067103X0101A3
A5A1C18	19-211	2C067103X0101A3	A5A1C91	19-96	2C067103X0101A3
A5A1C19	19-132	2C067103X0101A3	A5A1FL1	19-135	2B21A
A5A1C20	19-12	2C067103X0101A3	A5A1FL1	19-135	2B298
A5A1C21	19-62	2C067103X0101A3	A5A1FL5	19-186	526-9733-020
A5A1C22	19-110	2C067103X0101A3	A5A1FL5	19-186	526-9634-050
A5A1C23	19-48	2C067103X0101A3	A5A1FL5	19-186	526-9634-010
A5A1C24	19-52	2C067103X0101A3	A5A1FL5	19-186	526-9634-050
A5A1C27	19-133	2C067103X0101A3			
A5A1C28	19-202	DM5F101J050WV			
A5A1C29	19-129	DM5F101J050WV			

REFERENCE DESIGNATION INDEX

REFERENCE DESIGNATION	FIG - ITEM	PART NUMBER	REFERENCE DESIGNATION	FIG - ITEM	PART NUMBER
A5A1FL5	19-186	526-9634-010	A5A1R115	19-20	RCR07G473KS
A5A1FL5	19-186	526-9678-010	A5A1R116	19-32	RCR07G473KS
A5A1FL5	19-186	526-9733-020	A5A1R117	19-45	RCR07G222KS
A5A1FL5	19-186	526-9634-010	A5A1R118	19-11	RCR07G222KS
A5A1FL6	19-187	526-9643-010	A5A1R119	19-13	RCR07G222KS
A5A1FL7	19-77	526-9679-010	A5A1R12	19-119	RCR07G392KS
A5A1FL7	19-77	526-9734-020	A5A1R120	19-44	RCR07G222KS
A5A1FL7	19-77	526-9734-020	A5A1R121	19-43	RCR07G222KS
A5A1FL7	19-77	526-9652-010	A5A1R122	19-42	RCR07G222KS
A5A1FL7	19-77	526-9734-020	A5A1R123	19-39	RCR07G222KS
A5A1FL7	19-77	526-9652-010	A5A1R124	19-38	RCR07G222KS
A5A1FL7	19-77	526-9652-010	A5A1R125	19-36	RCR07G222KS
A5A1FL7	19-77	526-9652-050	A5A1R126	19-35	RCR07G222KS
A5A1L10	19-157	4S90537-49	A5A1R13	19-3	RCR07G222KS
A5A1L5	19-58	4S90538-04	A5A1R133	19-57A	RCR07G220KS
A5A1L6	19-137	4S90538-04	A5A1R14	19-56	RCR07G392KS
A5A1L7	19-10	4S90538-04	A5A1R15	19-55	RCR07G392KS
A5A1L8	19-112	4S90538-04	A5A1R16	19-49	RCR07G222KS
A5A1L9	19-118	1537-48	A5A1R17	19-50	RCR07G152KS
A5A1P1	19-218	141-1002-0002	A5A1R18	19-51	RCR07G222KS
A5A1P2	19-219	141-1002-0002	A5A1R19	19-53	RCR07G152KS
A5A1P4	19-220	141-1002-0002	A5A1R2	19-214	RCR07G121KS
A5A1P5	19-221	141-1002-0002	A5A1R3	19-212	RCR07G560KS
A5A1Q1	19-121	2N2907A	A5A1R32	19-141	RCR07G152KS
A5A1Q10	19-128	2N4416A	A5A1R33	19-131	RCR07G472KS
A5A1Q11	19-8	2N2222A	A5A1R34	19-143	RCR07G682KS
A5A1Q15	19-152	2N4416	A5A1R35	19-204	RCR07G100KS
A5A1Q16	19-167	2N4416	A5A1R36	19-208	RCR07G100KS
A5A1Q17	19-150	2N4416	A5A1R37	19-206	RCR07G562KS
A5A1Q18	19-172	2N4416	A5A1R37	19-206	RCR07G822KS
A5A1Q19	19-198	2N4416	A5A1R37	19-206	RCR07G822KS
A5A1Q2	19-57	2N2907A	A5A1R38	19-65	RCR07G471KS
A5A1Q20	19-180	2N4416	A5A1R39	19-64	RCR07G471KS
A5A1Q21	19-68	2N4416	A5A1R4	19-209	RCR07G121KS
A5A1Q22	19-87	2N4416	A5A1R40	19-74	RCR07G391JS
A5A1Q23	19-92	2N4416	A5A1R41	19-111	T055-1500-1F
A5A1Q24	19-93	2N4416	A5A1R42	19-114	RCR07G100KS
A5A1Q25	19-109	2N2907A	A5A1R43	19-117	RCR07G471KS
A5A1Q26	19-14	2N2907A	A5A1R44	19-7	RCR07G820KS
A5A1Q27	19-16	2N2907A	A5A1R45	19-46	T055-3010-1F
A5A1Q28	19-40	2N2907A	A5A1R46	19-47	RCR07G560KS
A5A1Q29	19-34	2N2907A	A5A1R47	19-5	RCR07G102KS
A5A1Q3	19-4	2N2222A	A5A1R5	19-122	RCR07G470KS
A5A1Q4	19-54	2N2222A	A5A1R6	19-124	RCR07G471KS
A5A1Q9	19-203	2N4416A	A5A1R60	19-75	RCR07G102KS
A5A1R1	19-2	RCR07G152KS	A5A1R61	19-151	RCR07G104KS
A5A1R10	19-61	RCR07G222KS	A5A1R62	19-155	RCR07G331KS
A5A1R100	19-21	RCR07G104KS	A5A1R63	19-156	RCR07G202JS
A5A1R101	19-24	RCR07G104KS	A5A1R63	19-156	RCR07G332KS
A5A1R102	19-25	RCR07G103KS	A5A1R64	19-159	RCR05G102JS
A5A1R103	19-26	RCR07G103KS	A5A1R65	19-164	RCR07G223KS
A5A1R104	19-81	RCR07G473KS	A5A1R66	19-165	RCR07G331KS
A5A1R105	19-94	RCR07G272KS	A5A1R67	19-176	RCR07G272KS
A5A1R106	19-95	RCR07G331KS	A5A1R68	19-147	RCR07G104KS
A5A1R107	19-108	RCR07G473KS	A5A1R69	19-193	RCR07G152KS
A5A1R108	19-105	RCR07G473KS	A5A1R69	19-193	RCR07G182KS
A5A1R109	19-103	RCR07G473KS	A5A1R69	19-193	RCR07G332KS
A5A1R11	19-120	RCR07G392KS	A5A1R69	19-193	RCR07G272KS
A5A1R110	19-19	RCR07G223KS	A5A1R69	19-193	RCR07G272KS
A5A1R111	19-33	RCR07G223KS	A5A1R69	19-193	RCR07G122KS
A5A1R112	19-106	RCR07G104KS	A5A1R69	19-193	RCR07G222KS
A5A1R113	19-104	RCR07G104KS	A5A1R69	19-193	RCR07G272KS
A5A1R114	19-102	RCR07G104KS	A5A1R7	19-130	RCR07G471KS
			A5A1R70	19-153	RCR07G223KS



## REFERENCE DESIGNATION INDEX

REFERENCE DESIGNATION	FIG - ITEM	PART NUMBER	REFERENCE DESIGNATION	FIG - ITEM	PART NUMBER
A5A1R72	19-169	RCR07G223KS	A5A2C38	20-11	2C067103X0101A3
A5A1R73	19-173	RCR07G331KS	A5A2C39	20-22	K05SK102M
A5A1R74	19-79	RCR07G102KS	A5A2C4	20-61	2C067103X0101A3
A5A1R75	19-78	RCR07G101KS	A5A2C40	20-15	2C067103X0101A3
A5A1R76	19-200	RCR07G104KS	A5A2C42	20-21	2C067103X0101A3
A5A1R77	19-199	RCR07G152KS	A5A2C43	20-3	2C067103X0101A3
A5A1R78	19-196	RCR07G223KS	A5A2C45	20-4	2C067103X0101A3
A5A1R8	19-210	RCR07G101KS	A5A2C46	20-7	2C067103X0101A3
A5A1R80	19-179	RCR07G223KS	A5A2C5	20-28	2C067103X0101A3
A5A1R81	19-184	RCR07G331KS	A5A2C6	20-29	2C067103X0101A3
A5A1R82	19-69	RCR07G104KS	A5A2C7	20-37	2C067103X0101A3
A5A1R83	19-70	RCR07G122KS	A5A2C8	20-34	2C067103X0101A3
A5A1R83	19-70	RCR07G272KS	A5A2C9	20-41	2C067103X0101A3
A5A1R83	19-70	RCR07G332KS	A5A2FL2	20-35	2B252
A5A1R83	19-70	RCR07G272KS	A5A2FL2	20-35	2B261
A5A1R83	19-70	RCR07G152KS	A5A2FL2	20-35	293-1252-020
A5A1R83	19-70	RCR07G182KS	A5A2FL2	20-35	293-1266-020
A5A1R83	19-70	RCR07G222KS	A5A2FL3	20-23	2B263
A5A1R83	19-70	RCR07G272KS	A5A2FL4	20-1	2B253
A5A1R84	19-71	RCR07G223KS	A5A2FL4	20-1	2B272
A5A1R86	19-82	RCR07G473KS	A5A2FL4	20-1	2B293
A5A1R87	19-83	RCR07G331KS	A5A2L1	20-59	MS90538-04
A5A1R88	19-89	RCR07G224KS	A5A2L2	20-27	MS90538-04
A5A1R89	19-91	RCR07G153KS	A5A2L3	20-38	MS90538-04
A5A1R9	19-1	RCR07G101KS	A5A2L4	20-33	MS90538-04
A5A1R90	19-98	RCR07G102KS	A5A2Q12	20-12	2N2907
A5A1R91	19-31	RCR07G103KS	A5A2Q13	20-18	352-0756-011
A5A1R92	19-29	RCR07G101KS	A5A2Q14	20-6	352-0756-011
A5A1R93	19-99	RCR07G103KS	A5A2Q5	20-45	2N2907
A5A1R94	19-190	RCR07G103KS	A5A2Q6	20-60	2N2907
A5A1R95	19-188	RCR07G103KS	A5A2Q7	20-46	2N2222A
A5A1R96	19-191	RCR07G103KS	A5A2Q8	20-56	2N2222A
A5A1R97	19-189	RCR07G103KS	A5A2R20	20-44	RCR07G101KS
A5A1R98	19-101	RCR07G103KS	A5A2R21	20-64	RCR07G101KS
A5A1R99	19-100	RCR07G103KS	A5A2R22	20-43	RCR07G222KS
A5A1T1	19-144	A263	A5A2R23	20-46	RCR07G392KS
A5A1T2	19-66	A261	A5A2R24	20-47	RCR07G392KS
A5A1T3	19-177	609-9440-001	A5A2R25	20-62	RCR07G222KS
A5A1T4	19-27	606-9440-001	A5A2R26	20-58	RCR07G392KS
A5A2	1-20	797-3585-002	A5A2R27	20-57	RCR07G392KS
A5A2	1-20	797-3585-003	A5A2R28	20-50	RCR07G222KS
A5A2	1-20	797-3585-010	A5A2R29	20-49	RCR07G152KS
A5A2	1-20	797-3585-012	A5A2R30	20-52	RCR07G222KS
A5A2	1-20	797-3585-011	A5A2R31	20-55	RCR07G152KS
A5A2	20-	797-3585-002	A5A2R48	20-10	RCR07G473KS
A5A2	20-	797-3585-003	A5A2R49	20-9	RCR07G104KS
A5A2	20-	797-3585-010	A5A2R50	20-13	RCR07G222KS
A5A2	20-	797-3585-011	A5A2R51	20-14	RCR07G222KS
A5A2	20-	797-3585-012	A5A2R52	20-16	RCR07G103KS
A5A2CR1	20-54	1N459	A5A2R53	20-17	RCR07G473KS
A5A2CR2	20-36	1N459	A5A2R54	20-19	RCR07G152KS
A5A2CR3	20-24	1N459	A5A2R55	20-20	RCR07G223KS
A5A2CR4	20-26	1N459	A5A2R57	20-2	RCR07G103KS
A5A2CR5	20-40	1N459	A5A2R58	20-5	RCR07G223KS
A5A2CR6	20-39	1N459	A5A2R59	20-8	RCR07G331KS
A5A2CR7	20-31	1N459	A6	16-	790-1048-008
A5A2CR8	20-32	1N459	A6	1-18	790-1048-021
A5A2C1	20-63	2C067103X0101A3	A6	1-18	790-1048-010
A5A2C10	20-30	2C067103X0101A3	A6	1-18	790-1048-008
A5A2C2	20-25	2C067103X0101A3	A6	1-18	790-1048-020
A5A2C25	20-51	2C067103X0101A3	A6	36-	790-1048-021
A5A2C26	20-53	2C067103X0101A3	A6	36-	790-1048-020
A5A2C3	20-42	2C067103X0101A3	A6A1	37-	618-3258-001

## REFERENCE DESIGNATION INDEX

REFERENCE DESIGNATION	FIG - ITEM	PART NUMBER	REFERENCE DESIGNATION	FIG - ITEM	PART NUMBER
A6A1	36-3	618-3258-001	A6A1C56	37-81	8131-050-651-104
A6A1CR1	37-96	1N3070			M
A6A1CR10	37-85	1N5767	A6A1C6	37-99	8131-050-651-104
A6A1CR2	37-97	1N3070			M
A6A1CR3	37-3	1N5767	A6A1C7	37-100	8131-050-651-104
A6A1CR4	37-2	1N5767			M
A6A1CR5	37-40	1N5767	A6A1C8	37-12	538002COP089R
A6A1CR6	37-42	1N5767	A6A1C9	37-107	2C067102X0101A3
A6A1CR7	37-120	1N5767	A6A1PL1	37-51	201
A6A1CR8	37-68	5082-8907	A6A1L10	37-144	MS75084-12
A6A1C1	37-101	8131-050-651-104	A6A1L11	37-67	MS75084-12
		M	A6A1L12	37-71	MS75083-09
A6A1C10	37-135	2C067102X0101A3	A6A1L13	37-63	240-2711-300
A6A1C11	37-14	538002COP089R	A6A1L14	37-18	240-2711-170
A6A1C12	37-47	DM5F101J050WV	A6A1L15	37-22	MS75083-09
A6A1C13	37-44	DM5F101J050WV	A6A1L16	37-28	240-2711-300
A6A1C14	37-115	2C067103X0101A3	A6A1L17	37-62	240-2711-300
A6A1C17	37-41	2C067103X0101A3	A6A1L18	37-57	MS75083-09
A6A1C18	37-110	2465-008W5T0102P	A6A1L19	37-84	MS75084-12
A6A1C19	37-30	8131-050-651-104	A6A1L20	37-104	240-2711-300
		M	A6A1L21	37-139	MS75084-12
A6A1C20	37-29	8131-050-651-104	A6A1L22	37-88	MS75083-03
		M	A6A1L3	37-94	240-2711-300
A6A1C21	37-116	8111B079C060-828	A6A1L4	37-109	240-2711-300
		C	A6A1L5	37-130	MS75085-03
A6A1C22	37-119	DM5F171J050WV	A6A1L6	37-111	MS75085-03
A6A1C23	37-129	2C067103X0101A3	A6A1L7	37-121	MS75085-03
A6A1C24	37-140	DM5F151J050WV	A6A1L8	37-43	MS75085-07
A6A1C25	37-138	8131-050-651-104	A6A1L9	37-123	240-2711-300
		M	A6A1P10	37-32	140-0530-9014
A6A1C26	37-143	DM5F151J050WV	A6A1P6	37-50	140-0530-9014
A6A1C27	37-70	DM5F301J050WV	A6A1P9	37-31	140-0530-9014
A6A1C28	37-66	2C067102X0101A3	A6A1Q1	37-17	FN2173
A6A1C29	37-102	DM5F151J050WV	A6A1Q2	37-48	FN2173
A6A1C3	37-105	8131-050-651-104	A6A1Q3	37-117	FN2173
		M	A6A1Q4	37-87	2N222A
A6A1C30	37-86	2C067102X0101A3	A6A1Q5	37-75	2N5109
A6A1C31	37-77	DM5F301J050WV	A6A1Q6	37-23	2N5109
A6A1C32	37-61	DM5F301J050WV	A6A1Q7	37-52	2N5109
A6A1C33	37-64	2C067103X0101A3	A6A1RT1	37-125	23TD21
A6A1C34	37-65	DM5F151J050WV	A6A1R10	37-46	RCR05G100J8
A6A1C35	37-133	DM5F151J050WV	A6A1R11	37-112	RCR05G682J8
A6A1C36	37-15	M39003-01-2029	A6A1R13	37-114	RCR05G100J8
A6A1C37	37-20	2C067102X0101A3	A6A1R14	37-118	RCR05G100J8
A6A1C38	37-24	DM5F151J050WV	A6A1R15	37-124	RCR05G331J8
A6A1C39	37-128	2C067103X0101A3	A6A1R16	37-37	RCR05G331J8
A6A1C40	37-127	2C067102X0101A3	A6A1R17	37-36	RCR05G221J8
A6A1C41	37-38	8131-050-651-104	A6A1R18	37-13	61PNR500
		M	A6A1R19	37-72	RCR05G100J8
A6A1C42	37-136	2465-008W5T0102P	A6A1R20	37-9	J329H1-502
A6A1C43	37-122	2C067103X0101A3	A6A1R21	37-78	RCR07G180K8
A6A1C44	37-141	DM5E240D050WV	A6A1R22	37-69	RCR05G152J8
A6A1C45	37-90	DM5F301J050WV	A6A1R23	37-79	RCR05G331J8
A6A1C46	37-148	DM5E240D050WV	A6A1R24	37-16	T055-1K1F
A6A1C47	37-146	M39003-01-2029	A6A1R25	37-19	RCR05G181J8
A6A1C48	37-145	DM5F151J050WV	A6A1R25	37-19	RCR05G221J8
A6A1C49	37-6	DM5C120D050WV	A6A1R25	37-19	RCR05G271J8
A6A1C5	37-93	2C067103X0101A3	A6A1R25	37-19	RCR05G331J8
A6A1C50	37-8	DM5C120D050WV	A6A1R25	37-19	RCR05G391J8
A6A1C51	37-58	2C067103X0101A3	A6A1R25	37-19	RCR05G561J8
A6A1C52	37-59	DM5F151J050WV	A6A1R25	37-19	RCR05G102J8
A6A1C53	37-83	2C067102X0101A3	A6A1R26	37-21	RCR05G680J8
A6A1C54	37-54	DM5F301J050WV	A6A1R27	37-26	T055-27R4-1F
A6A1C55	37-106	2C067103X0101A3			

## REFERENCE DESIGNATION INDEX

REFERENCE DESIGNATION	FIG - ITEM	PART NUMBER	REFERENCE DESIGNATION	FIG - ITEM	PART NUMBER
A6A1R28	37-25	T055-2-87K1F	A6A2C106	38-36	8131-050-651-104 M
A6A1R29	37-27	T055-3010-1F	A6A2C107	38-49	8131-050-651-104 M
A6A1R30	37-126	55D1820F	A6A2C108	38-37	8131-050-651-104 M
A6A1R31	37-45	3329H1-50P	A6A2C109	38-48	2C067103X0101A3
A6A1R32	37-74	RCR05G4R7KS	A6A2C110	38-53	8131-050-651-104 M
A6A1R33	37-113	RCR05G821JS	A6A2C111	38-32	8131-050-651-104 M
A6A1R34	37-39	RCR05G102JS	A6A2C112	38-52	2C067103X0101A3
A6A1R35	37-7	61PNR500	A6A2C113	38-33	2C067103X0101A3
A6A1R36	37-142	RCR05G101JS	A6A2C114	38-51	2C067103X0101A3
A6A1R37	37-92	RCR05G101JS	A6A2C115	38-39	2C067103X0101A3
A6A1R39	37-89	RCR05G331JS	A6A2C116	38-46	2C067103X0101A3
A6A1R4	37-95	RCR07G680KS	A6A2C117	38-31	8131-050-651-104 M
A6A1R40	37-60	RCR05G152JS	A6A2C118	38-27	CM05FD391J03
A6A1R41	37-56	RCR05G100JS	A6A2FL101	38-43	A275
A6A1R42	37-91	RCR05G4R7KS	A6A2FL102	38-30	A259
A6A1R43	37-55	RCR07G220KS	A6A2L101	38-15	MS90538-20
A6A1R44	37-82	RCR07G101KS	A6A2L102	38-11	MS90538-20
A6A1R45	37-103	RCR05G332JS	A6A2L103	38-20	MS90538-20
A6A1R46	37-53	RCR05G100JS	A6A2L104	38-6	MS90538-20
A6A1R47	37-73	RCR05G100JS	A6A2L105	38-25	MS90538-06
A6A1R48	37-80	RCR05G680JS	A6A2L106	38-1	MS90538-06
A6A1R5	37-1	RCR05G101JS	A6A2L107	38-22	MS90538-20
A6A1R6	37-98	RCR05G104JS	A6A2L108	38-26A	LT4K036
A6A1R7	37-108	RCR05G220JS	A6A2R101	38-12	RCR20G820KS
A6A1R8	37-134	RCR05G332JS	A6A2R102	38-21	RCR20G120KS
A6A1R9	37-131	RCR05G100JS	A6A2R102	38-21	RCR07G180KS
A6A1T1	37-4	A260	A6A2R102	38-21	RCR20G120KS
A6A1T2	37-137	790-0259-001	A6A2R103	38-4	RCR20G120KS
A6A1T3	37-132	790-0260-001	A6A2R103	38-4	RCR07G180KS
A6A1T4	37-49	A284	A6A2R103	38-4	RCR20G120KS
A6A1T5	37-34	278-0349-020	A6A2R104	38-50	RCR20G101KS
A6A1T6	37-35	278-0401-020	A6A2R104	38-50	RCR20G680KS
A6A1T7	37-147	618-3255-001	A6A2R104	38-50	RCR20G101KS
A6A1U1	37-8	350-3080-020	A6A2R105	38-5	RCR20G820KS
A6A1Z1	37-11	790-0266-001	A6A2R106	38-26	RCR20G820KS
A6A1Z2	37-10	790-0266-001	A6A2R107	38-34	RCR20G820KS
A6A2	36-23	618-7678-001	A6A2R108	38-38	RCR07G102KS
A6A2	36-23	618-7678-002	A6A2R109	38-47	RCR07G102KS
A6A2	38-	618-7678-001	A6A2R110	38-13	RCR20G151KS
A6A2	38-	618-7678-002	A6A2R111	38-42	RCR20G390KS
A6A2CR101	38-17	1N458	A6A2R112	38-14	RCR20G151KS
A6A2CR102	38-16	1N458	A6A2R113	38-29	RN65D2150F
A6A2CR103	38-9	1N458	A6A2R113	38-29A	RN65D2150F
A6A2CR104	38-10	1N458	A6A2R114	38-27	RCR20G390KS
A6A2CR105	38-18	1N458	A6A2R114	38-30B	RN65D46R4F
A6A2CR106	38-19	1N458	A6A2R115	38-28	RN65D2150F
A6A2CR107	38-8A	1N458	A6A2R115	38-28A	RN65D2150F
A6A2CR107	38-8	1N458	A6A2R116	38-30A	RN65D46R4F
A6A2CR107	38-8A	1N458	A6A2R116	38-30A	RN65D46R4F
A6A2CR108	38-7	1N458	A6CR1	16-90	1N3070
A6A2CR109	38-24	1N458	A6CR10	16-167	1N5767
A6A2CR110	38-23	1N458	A6CR101	17-94	1N458
A6A2CR111	38-3	1N458	A6CR102	17-93	1N458
A6A2CR112	38-2	1N458	A6CR103	17-32	1N458
A6A2C101	38-35	8131-050-651-104 M	A6CR104	17-33	1N458
A6A2C102	38-41	8131-050-651-104 M	A6CR105	17-91	1N458
A6A2C103	38-45	8131-050-651-104 M	A6CR106	17-90	1N458
A6A2C104	38-40	8131-050-651-104 M			
A6A2C105	38-44	2C067103X0101A3			

## REFERENCE DESIGNATION INDEX

REFERENCE DESIGNATION	FIG - ITEM	PART NUMBER	REFERENCE DESIGNATION	FIG - ITEM	PART NUMBER
A6CR107	17-34	1N458	A6C111	17-38	C22C104M
A6CR108	17-35	1N458	A6C112	17-105	C22C104M
A6CR109	17-89	1N458	A6C113	17-21	C22A103K
A6CR110	17-88	1N458	A6C114	17-41	C22C104M
A6CR111	17-36	1N458	A6C115	17-85	C22A103K
A6CR112	17-37	1N458	A6C116	17-108	C22A103K
A6CR113	17-87	1N458	A6C117	17-19	C22A103K
A6CR114	17-86	1N458	A6C118	17-44	C22C104M
A6CR115	17-39	1N458	A6C119	17-110	C22A103K
A6CR116	17-40	1N458	A6C12	16-101	DM5F101J050WV
A6CR117	17-84	1N458	A6C120	17-18	C22A103K
A6CR118	17-83	1N458	A6C121	17-47	C22A103K
A6CR119	17-42	1N458	A6C122	17-80	C22A103K
A6CR120	17-43	1N458	A6C123	17-112	C22A103K
A6CR121	17-82	1N458	A6C124	17-12	C22A103K
A6CR122	17-81	1N458	A6C125	17-48	C22A103K
A6CR123	17-45	1N458	A6C126	17-51	C22A103K
A6CR124	17-46	1N458	A6C127	17-115	C22A103K
A6CR125	17-79	1N458	A6C128	17-10	C22A103K
A6CR126	17-78	1N458	A6C129	17-54	C22A103K
A6CR127	17-49	1N458	A6C13	16-100	DM5F101J050WV
A6CR128	17-50	1N458	A6C130	17-75	C22A103K
A6CR129	17-77	1N458	A6C131	17-117	C22A103K
A6CR130	17-76	1N458	A6C132	17-8	C22A103K
A6CR131	17-52	1N458	A6C133	17-57	C22A103K
A6CR132	17-53	1N458	A6C134	17-62	C22A103K
A6CR133	17-74	1N458	A6C135	17-6	C22A103K
A6CR134	17-73	1N458	A6C136	17-3	C22A103K
A6CR135	17-55	1N458	A6C137	17-64	C22A103K
A6CR136	17-56	1N458	A6C138	17-5	C22A103K
A6CR137	17-72	1N458	A6C139	17-69	C22C104M
A6CR138	17-71	1N458	A6C14	16-127	C22A103K
A6CR139	17-58	1N458	A6C140	17-70	C22A103K
A6CR140	17-59	1N458	A6C141	17-1	C22A103K
A6CR2	16-89	1N3070	A6C17	16-105	C22A103K
A6CR3	16-91	1N5767	A6C18	16-119	2482-010W5T102AA
A6CR4	16-138	1N5767	A6C19	16-134	2C067104X0101A3
A6CR5	16-102	1N5767	A6C20	16-111	2C067104X0101A3
A6CR6	16-106	1N5767	A6C21	16-128	811B079C0G0-828 C
A6CR601	18-51	1N3070	A6C22	16-132	DM5F171J050WV
A6CR602	18-50	1N3070	A6C23	16-133	C22A103K
A6CR603	18-49	1N5767	A6C24	16-174	DM5F151J050WV
A6CR604	18-35	1N459	A6C25	16-175	M39003-01-2029
A6CR605	18-36	1N459	A6C26	16-172	C22A102M
A6CR7	16-115	1N5767	A6C27	16-155	2C067102X0101A3
A6CR701	16-65	1N459	A6C28	16-157	C22A102M
A6CR701	36-26G	1N459	A6C29	16-161	C22A102M
A6CR702	16-69	1N459	A6C3	16-144	2482-010W5T102AA
A6CR702	36-26D	1N459	A6C30	16-160	C22A102M
A6CR8	16-156	5082-8907	A6C301	16-230	2465-009W5T0102P
A6C1	16-145	2482-010W5T102AA	A6C301	36-16	2465-009W5T0102P
A6C10	16-143	2482-010W5T102AA	A6C302	16-232	2465-009W5T0102P
A6C101	17-98	C22C104M	A6C302	36-12	2465-009W5T0102P
A6C102	17-30	C22C104M	A6C303	16-231	2465-009W5T0102P
A6C103	17-99	C22C104M	A6C303	36-17	2465-009W5T0102P
A6C104	17-29	C22A103K	A6C304	16-233	2465-009W5T0102P
A6C105	17-92	C22A103K	A6C304	36-13	2465-009W5T0102P
A6C106	17-31	C22A103K	A6C305	16-234	2465-009W5T0102P
A6C107	17-97	C22C104M	A6C305	36-17A	2465-009W5T0102P
A6C108	17-23	C22C104M	A6C306	16-235	2465-009W5T0102P
A6C109	17-100	C22C104M	A6C306	36-13A	2465-009W5T0102P
A6C11	16-85	538002COP089R	A6C31	16-168	C22A102M
A6C110	17-24	C22A103K			

## REFERENCE DESIGNATION INDEX

REFERENCE DESIGNATION	FIG - ITEM	PART NUMBER	REFERENCE DESIGNATION	FIG - ITEM	PART NUMBER
A6C32	16-165	C22A102M	A6C613	18-20	DM5F910J050WV
A6C33	16-182	2482-010W5T102AA	A6C614	18-21	DM5F910J050WV
A6C34	16-162	DM5F151J050WV	A6C614	18-21	DM5F101J050WV
A6C35	16-198	DM5F151J050WV	A6C615	18-55	DM5C150D050WV
A6C36	16-199	M39003-01-2029	A6C616	18-56	DM5E430J050WV
A6C37	16-196	C22A102M	A6C616	18-56	DM5E510J050WV
A6C38	16-189	DM5F151J050WV	A6C617	18-24A	071F102J0
A6C39	16-206	2482-010W5T102AA	A6C618	18-25	2C067103X0101A3
A6C40	16-192	2C067102X0101A3	A6C619	18-24	150D225X0020A2
A6C401	16-39	2465-009W5T0102P	A6C620	18-22	2C067103X0101A3
A6C401	36-33	2465-009W5T0102P	A6C621	18-16	2C067102X0101A3
A6C402	16-40	2465-009W5T0102P	A6C622	18-38	2C067104X0101A3
A6C402	36-34	2465-009W5T0102P	A6C623	18-37	2C067103X0101A3
A6C403	16-41	2465-009W5T0102P	A6C624	18-41	2C067103X0101A3
A6C403	36-36	2465-009W5T0102P	A6C625	18-46	2C067104X0101A3
A6C404	16-42	2465-009W5T0102P	A6C626	18-44	2C067103X0101A3
A6C404	36-37	2465-009W5T0102P	A6C627	18-54	DM5C080D050WV
A6C405	16-38	2465-009W5T0102P	A6C7	16-95	2C067104X0101A3
A6C405	36-42	2465-009W5T0102P	A6C701	16-67	2C067104X0101A3
A6C406	16-37	2465-009W5T0102P	A6C701	36-26F	2C067104X0101A3
A6C406	36-41	2465-009W5T0102P	A6C8	16-84	538002C0P089R
A6C407	16-36	2465-009W5T0102P	A6C9	16-146	2482-010W5T102AA
A6C407	36-40	2465-009W5T0102P	A6FL1	16-86	2Q1
A6C408	16-35	2465-009W5T0102P	A6FL202	16-9	A275
A6C408	36-39	2465-009W5T0102P	A6FL203	16-10	A251
A6C409	16-31	2465-009W5T0102P	A6FL204	16-11	A252
A6C409	36-35	2465-009W5T0102P	A6FL205	16-12	A253
A6C41	16-110	2C067104X0101A3	A6FL206	16-13	A254
A6C410	16-32	2465-009W5T0102P	A6FL207	16-14	A255
A6C410	36-38	2465-009W5T0102P	A6FL208	16-15	A256
A6C411	16-33	2465-009W5T0102P	A6FL209	16-16	A257
A6C411	36-42B	2465-009W5T0102P	A6FL210	16-17	A258
A6C412	16-34	2465-009W5T0102P	A6FL501	16-63	A188
A6C412	36-42A	2465-009W5T0102P	A6FL501	36-26	A188
A6C413	16-54	2465-009W5T0102P	A6FL601	18-1	609-1651-001
A6C413	36-48	2465-009W5T0102P	A6FL601	18-1	609-1557-001
A6C414	16-53	2465-009W5T0102P	A6K701	16-72	3SAV1556A2
A6C414	36-47	2465-009W5T0102P	A6K701	36-26J	3SAV1556A2
A6C415	16-52	2465-009W5T0102P	A6L10	16-158	240-2711-170
A6C415	36-46	2465-009W5T0102P	A6L101	17-96	MS90538-20
A6C416	16-51	2465-009W5T0102P	A6L102	17-28	MS90538-20
A6C417	16-47	2465-009W5T0102P	A6L103	17-95	MS90538-20
A6C418	16-48	2465-009W5T0102P	A6L104	17-27	MS90538-20
A6C419	16-49	2465-009W5T0102P	A6L105	17-106	MS90538-20
A6C42	16-120	2482-010W5T102AA	A6L106	17-22	MS90538-20
A6C420	16-50	2465-009W5T0102P	A6L107	17-107	MS90538-20
A6C421	16-46	2465-009W5T0102P	A6L108	17-20	MS90538-20
A6C422	16-45	2465-009W5T0102P	A6L109	17-109	MS90538-20
A6C423	16-44	2465-009W5T0102P	A6L11	16-176	240-2711-170
A6C423	36-48B	2465-009W5T0102P	A6L110	17-17	MS90538-20
A6C424	16-43	2465-009W5T0102P	A6L111	17-111	MS90538-20
A6C424	36-48A	2465-009W5T0102P	A6L112	17-14	MS90538-20
A6C43	16-130	2C067103X0101A3	A6L113	17-113	MS90538-20
A6C5	16-93	2C067103X0101A3	A6L114	17-11	MS90538-20
A6C50	16-82A	DM5C010D050WV	A6L115	17-65	MS90538-10
A6C6	16-88	2C067104X0101A3	A6L116	17-9	MS90538-10
A6C607	18-52	M39003-01-2111	A6L117	17-61	MS90538-10
A6C608	18-9	2C067103X0101A3	A6L118	17-7	MS90538-10
A6C609	18-10	DM5E680J050WV	A6L119	17-63	MS90538-10
A6C610	18-4	2C067104X0101A3	A6L12	16-170	MS75083-09
A6C611	18-5	2C067104X0101A3	A6L120	17-4	MS90538-10
A6C612	18-8	DM5E680J050WV	A6L121	17-68	MS90538-20
A6C613	18-20	DM5F101J050WV	A6L13	16-141	240-2711-300

## REFERENCE DESIGNATION INDEX

REFERENCE DESIGNATION	FIG - ITEM	PART NUMBER	REFERENCE DESIGNATION	FIG - ITEM	PART NUMBER
A6L14	16-194	240-2711-170	A6P9	16-153	140-0530-9014
A6L15	16-200	MS75083-09	A6Q1	16-99	FN2173
A6L16	16-118	240-2711-300	A6Q2	16-98	FN2173
A6L3	16-92	240-2711-300	A6Q3	16-108	FN2173
A6L301	16-227	MS90538-06	A6Q4	16-180	2N2222A
A6L301	36-14	MS90538-06	A6Q5	16-177	2N5109
A6L302	16-228	MS90538-06	A6Q6	16-203	2N5109
A6L302	36-15	MS90538-06	A6Q601	18-33	352-0766-011
A6L303	16-220	MS90537-41	A6Q601	18-33	2N5109
A6L303	36-9	MS90537-37	A6Q601	18-33	2N5109
A6L303	36-9	MS90537-37	A6Q701	16-71	2N2222A
A6L303	36-9	MS90537-41	A6Q701	36-26H	2N2222A
A6L304	16-221	MS90537-41	A6RT1	16-109	23TD21
A6L304	36-10	MS90537-41	A6R10	16-122	RCR05G100JS
A6L304	36-10	MS90537-37	A6R101	17-26	RCR07G910JS
A6L304	36-10	MS90537-37	A6R102	17-25	RCR07G180JS
A6L305	16-229	MS90538-06	A6R103	17-102	RCR07G180JS
A6L305	36-15A	MS90538-06	A6R104	17-101	RCR20G680JS
A6L4	16-94	240-2711-300	A6R105	17-103	RCR07G910JS
A6L401	16-30	MS90537-49	A6R106	17-104	RCR07G910JS
A6L401	36-45	MS90537-49	A6R107	17-16	RCR07G910JS
A6L402	16-29	MS90538-06	A6R108	17-15	RCR07G910JS
A6L402	36-44	MS90538-06	A6R109	17-13	RCR07G910JS
A6L403	16-28	MS90538-06	A6R11	16-124	RCR05G682JS
A6L403	36-43	MS90538-06	A6R110	17-114	RCR07G910JS
A6L404	16-27	MS90538-06	A6R111	17-116	RCR07G910JS
A6L405	16-26	MS90538-06	A6R112	17-118	RCR07G910JS
A6L406	16-25	MS90538-06	A6R113	17-60	RCR07G910JS
A6L407	16-24	MS90538-06	A6R114	17-67	RCR20G910JS
A6L408	16-23	MS90538-06	A6R115	17-66	RCR20G431JS
A6L409	16-22	MS90538-06	A6R116	17-2	RCR07G102JS
A6L410	16-21	MS90538-06	A6R13	16-107	RCR05G100JS
A6L411	16-20	MS90538-06	A6R14	16-131	RCR05G100JS
A6L411	36-45B	MS90538-06	A6R15	16-112	RCR05G331JS
A6L412	16-19	MS90538-06	A6R16	16-114	RCR05G331JS
A6L412	36-45A	MS90538-06	A6R17	16-116	RCR05G221JS
A6L5	16-126	MS75085-03	A6R18	16-173	TO55-3010-1F
A6L6	16-123	240-2711-300	A6R19	16-171	RCR05G100JS
A6L604	18-23	278-0404-010	A6R20	16-82B	RCR05G752JS
A6L605	18-27	278-0404-010	A6R20	16-82B	RCR05G103JS
A6L606	18-19	609-1548-001	A6R20	16-82B	RCR05G153JS
A6L607	18-34	MS75084-17	A6R20	16-82B	RCR05G123JS
A6L608	18-13	MS75084-12	A6R20	16-82B	RCR05G682JS
A6L609	18-43	MS90537-41	A6R20	16-82B	RCR05G822JS
A6L610	18-42	MS90537-41	A6R20	16-82B	RCR05G222JS
A6L7	16-129	MS75085-03	A6R20	16-82B	RCR05G272JS
A6L701	16-70	MS90537-25	A6R20	16-82B	RCR05G332JS
A6L701	36-26E	MS90537-25	A6R20	16-82B	RCR05G392JS
A6L8	16-103	MS75085-07	A6R20	16-82B	RCR05G472JS
A6L9	16-117	240-2711-300	A6R20	16-82B	RCR05G562JS
A6P10	16-153	140-0530-9014	A6R21	16-169	55D22R1F
A6P4	18-59	140-0530-9014	A6R22	16-166	RCR07G152KS
A6P5	16-62	141-1002-0002	A6R23	16-163	TO55-3320-1F
A6P5	36-24	141-1002-0002	A6R24	16-197	TO55-1K1F
A6P6	16-153	140-0530-9014	A6R25	16-195	RCR05G331JS
A6P7A	16-223	790-1378-001	A6R26	16-201	RCR05G680JS
A6P7A	36-6	790-1378-001	A6R27	16-202	TO55-27R4-1F
A6P7B	16-225	790-1378-002	A6R28	16-191	TO55-2-87K1F
A6P7B	36-7	790-1378-002	A6R29	16-190	TO55-3010-1F
A6P8A	16-58	790-1377-001	A6R30	16-193	55D1820F
A6P8A	36-29	790-1377-001	A6R31	16-142	3329H1-502
A6P8B	16-60	790-1377-002	A6R32	16-164	RCR05G4R7KS
A6P8B	36-30	790-1377-002	A6R33	16-125	RCR05G152JS

## REFERENCE DESIGNATION INDEX

REFERENCE DESIGNATION	FIG - ITEM	PART NUMBER	REFERENCE DESIGNATION	FIG - ITEM	PART NUMBER
A6R34	16-113	RCR05G102JS	A7C1	15-76	2C067103X0101A3
A6R4	16-140	RCR07G680KS	A7C1	35-20	8131-050-651-104
A6R5	16-137	RCR05G101JS			M
A6R6	16-139	RCR05G332JS	A7C1	34-18	8131-050-651-104
A6R601	18-48	RCR07G101KS			M
A6R604	18-12	RCR05G100JS	A7C10	15-65	2C067103X0101A3
A6R605	18-11	RCR05G100JS	A7C11	15-36	2C067104X0101A3
A6R606	18-31	61PNR2K	A7C12	15-63	2C067104X0101A3
A6R607	18-14	RCR05G103JS	A7C2	15-16	2C067103X0101A3
A6R608	18-7	RCR05G103JS	A7C2	34-21	8131-050-651-104
A6R609	18-17	RCR05G100JS			M
A6R610	18-18	RCR05G100JS	A7C2	35-23	8131-050-651-104
A6R611	18-53	RCR05G472JS			M
A6R612	18-57	RCR05G472JS	A7C3	15-15	2C067103X0101A3
A6R613	18-26	RCR07G470KS	A7C3	34-23	2C067103X0101A3
A6R614	18-28	RCR07G220KS	A7C3	35-26	2C067103X0101A3
A6R615	18-29	RCR05G272JS	A7C4	15-35	2C067103X0101A3
A6R616	18-39	55D2670F	A7C4	34-17	2C067103X0101A3
A6R617	18-30	RCR07G270KS	A7C4	35-19	2C067103X0101A3
A6R618	18-32	RCR05G331JS	A7C5	15-57	2C067103X0101A3
A6R619	18-40	RCR07G682KS	A7C5	35-22	2C067103X0101A3
A6R620	18-47	RCR07G470KS	A7C5	34-20	2C067103X0101A3
A6R621	18-45	RCR07G222KS	A7C6	15-29	2C067103X0101A3
A6R622	18-6	RCR07G102JS	A7C7	15-22	2C067103X0101A3
A6R7	16-96	RCR05G220JS	A7C8	15-26	2C067103X0101A3
A6R701	16-66	RCR07G103KS	A7C9	15-68	2C067103X0101A3
A6R701	36-26B	RCR07G103KS	A7Q1	15-83	2N2222A
A6R702	16-68	RCR07G100KS	A7Q1	34-3	2N2222A
A6R702	36-26C	RCR07G100KS	A7Q1	35-4	2N2222A
A6R8	16-97	RCR05G332JS	A7Q10	15-30	2N3135
A6R9	16-104	RCR05G100JS	A7Q11	15-21	2N3135
A6T1	16-147	A260	A7Q11	15-21	2N2907A
A6T2	16-148	790-0259-001	A7Q12	15-27	2N3135
A6T3	16-149	790-0260-001	A7Q12	15-27	2N2907A
A6T4	16-150	A217	A7Q13	15-70	2N3135
A6T5	16-151	A216	A7Q13	15-70	2N2907A
A6T6	16-152	A296	A7Q14	15-66	2N2907A
A6U1	16-87	350-3072-020	A7Q14	15-66	2N3135
A6U601	18-15	350-3072-020	A7Q2	15-78	2N2907A
A6VR9	16-159	1N746A	A7Q2	15-78	2N3135
A6Z1	16-135	790-0266-001	A7Q2	35-10	2N2907A
A6Z2	16-136	790-0266-001	A7Q2	34-8	2N2907A
A7	15-	778-2928-003	A7Q3	15-11	2N2222A
A7	1-17	608-9121-001	A7Q3	34-14	2N2907A
A7	1-17	778-2928-003	A7Q3	35-16	2N2907A
A7	1-17	608-9087-001	A7Q4	15-77	2N2907A
A7	35-	608-9121-001	A7Q4	15-77	2N3135
A7	34-	608-9087-001	A7Q4	35-13	2N2907A
A7CR1	34-29	1N459	A7Q4	34-11	2N2907A
A7CR1	35-1	1N459	A7Q5	15-43	2N2222A
A7CR2	34-28	1N459	A7Q6	15-14	2N3135
A7CR2	35-35	1N459	A7Q6	15-14	2N2907A
A7CR3	34-27	1N459	A7Q7	15-40	2N2222A
A7CR3	35-33	1N459	A7Q8	15-37	2N3135
A7CR4	15-19	1N746A	A7Q8	15-37	2N2907A
A7CR4	34-25	1N459	A7Q9	15-56	2N3135
A7CR4	35-31	1N459	A7R1	15-51	RCR07G222KS
A7CR5	34-26	1N459	A7R1	34-4	RCR07G103KS
A7CR5	35-32	1N459	A7R1	35-5	RCR07G103KS
A7CR6	35-7B	1N459	A7R10	15-17	RCR20G152KS
A7CR6	34-23A	1N459	A7R10	35-12	RCR07G102KS
A7CR6	34-6A	1N459	A7R10	34-10	RCR07G102KS
A7CR7	35-7C	1N459	A7R11	15-46	RCR07G222KS

## REFERENCE DESIGNATION INDEX

REFERENCE DESIGNATION	FIG - ITEM	PART NUMBER	REFERENCE DESIGNATION	FIG - ITEM	PART NUMBER
A7R11	34-19	RCR07G152K8	A7U13	15-87	SG142
A7R11	35-21	RCR07G152K8	A7U14	15-86	SG142
A7R12	15-45	RCR07G152K8	A7U15	15-85	SG142
A7R12	35-14	RCR07G473K8	A7U16	15-50	RG372K
A7R12	34-12	RCR07G473K8	A7U17	15-44	RG372K
A7R13	15-12	RCR07G471K8	A7U2	15-1	RG372K
A7R13	34-23B	RCR07G103K8	A7U2	35-8	MC7404P
A7R13	35-7A	RCR07G103K8	A7U2	34-6	MC7404P
A7R14	15-13	RCR07G222K8	A7U3	15-3	RG372K
A7R15	15-42	RCR07G222K8	A7U3	35-7	MC7420P
A7R16	15-41	RCR07G152K8	A7U3	34-5	MC7420P
A7R17	15-39	RCR07G471K8	A7U4	15-48	RG372K
A7R18	15-38	RCR07G222K8	A7U4	35-34	MC7404P
A7R19	15-34	RCR20G152K8	A7U5	15-47	RG372K
A7R2	15-52	RCR07G152K8	A7U5	35-30	MC7404P
A7R2	35-3	RCR07G223K8	A7U6	15-4	SG192
A7R2	34-2	RCR07G223K8	A7U6	35-29	MC7404P
A7R20	15-55	RCR07G121K8	A7U7	15-5	SG192
A7R21	15-54	RCR07G152K8	A7U7	35-28	MC7404P
A7R22	15-58	RCR20G152K8	A7U8	15-6	SG192
A7R23	15-31	RCR07G121K8	A7U8	35-27	MC7404P
A7R24	15-32	RCR07G152K8	A7U9	15-7	SG142
A7R25	15-28	RCR20G152K8	A7U9	35-24	MC7404P
A7R26	15-72	RCR07G121K8	A7VR1	15-53	1N746A
A7R27	15-73	RCR07G121K8	A7VR2	15-33	1N746A
A7R28	15-23	RCR20G152K8	A7VR3	15-74	1N746A
A7R29	15-24	RCR07G121K8	A7VR5	15-62	1N746A
A7R3	15-82	RCR07G471K8	A7VR6	15-59	1N746A
A7R3	35-2	RCR07G473K8	A8	13-	77A-2924-004
A7R3	34-1	RCR07G473K8	A8	13-	77B-2924-006
A7R30	15-20	RCR07G152K8	A8	14-	624-5744-001
A7R31	15-25	RCR20G152K8	A8	13-	77B-2924-007
A7R32	15-69	RCR07G121K8	A8	1-16	77A-2924-004
A7R33	15-71	RCR07G152K8	A8	1-16	624-5744-001
A7R34	15-67	RCR20G152K8	A8	1-16	77B-2924-006
A7R35	15-61	RCR07G121K8	A8	1-16	77B-2924-007
A7R36	15-60	RCR07G152K8	A8CR1	13-8	1N459
A7R37	15-64	RCR20G152K8	A8CR1	14-57	1N459
A7R38	15-18	RCR20G152K8	A8CR10	14-119	1N459
A7R4	15-81	RCR07G222K8	A8CR10	13-22	1N459
A7R4	35-9	RCR07G102K8	A8CR11	13-19	1N459
A7R4	34-7	RCR07G102K8	A8CR11	14-169	1N459
A7R5	15-9	RCR07G222K8	A8CR12	14-170	1N459
A7R5	34-22	RCR07G152K8	A8CR12	13-20	1N459
A7R5	35-25	RCR07G152K8	A8CR13	14-171	1N459
A7R6	15-10	RCR07G152K8	A8CR13	13-21	1N459
A7R6	35-11	RCR07G473K8	A8CR14	14-110	1N459
A7R6	34-9	RCR07G473K8	A8CR14	13-18	1N459
A7R7	15-80	RCR07G471K8	A8CR15	13-13	1N459
A7R7	35-15	RCR07G102K8	A8CR15	14-167	1N459
A7R7	34-13	RCR07G102K8	A8CR16	13-14	1N459
A7R8	15-79	RCR07G222K8	A8CR16	14-120	1N459
A7R8	34-16	RCR07G152K8	A8CR17	13-23	1N459
A7R8	35-18	RCR07G152K8	A8CR17	14-121	1N459
A7R9	15-75	RCR20G152K8	A8CR18	13-16	1N459
A7R9	34-15	RCR07G473K8	A8CR18	14-164	1N459
A7R9	35-17	RCR07G473K8	A8CR19	14-122	1N459
A7U1	15-2	RG372K	A8CR2	14-64	1N459
A7U1	34-24	MC7400P	A8CR2	13-7	1N459
A7U1	35-6	MC7400P	A8CR20	14-123	1N459
A7U10	15-8	RG372K	A8CR20	13-16A	1N459
A7U11	15-49	SG142	A8CR21	13-15	1N459
A7U12	15-88	SG192	A8CR21	14-124	1N459



## REFERENCE DESIGNATION INDEX

REFERENCE DESIGNATION	FIG - ITEM	PART NUMBER	REFERENCE DESIGNATION	FIG - ITEM	PART NUMBER
A8CR22	14-125	1N459	ARR1	14-59	RCR05G331K
A8CR22	13-12	1N459	A8R1	13-24	RCR07G102KS
A8CR23	13-17	1N459	ARR10	14-63	RCR05G102K
A8CR23	14-126	1N459	A8R11	14-116	RCR05G102K
A8CR24	13-33	1N459	ARR12	14-118	RCR05G102K
A8CR24	14-162	1N459	A8R13	14-168	RCR05G102K
A8CR25	14-159	1N459	ARR14	14-166	RCR05G472K
A8CR25	13-26	1N459	A8R14	14-166	RCR05G222K
A8CR26	14-69	1N459	ARR15	14-165	RCR05G102K
A8CR26	13-34	1N459	A8R15	14-165	RCR05G222K
A8CR27	14-68	1N459	ARR15	14-165	RCR05G472K
A8CR27	13-2A	1N459	A8R16	14-163	RCR05G472K
A8CR28	14-106	1N459	ARR16	14-163	RCR05G102K
A8CR28	13-29	1N459	A8R16	14-163	RCR05G222K
A8CR29	13-11	1N459	ARR17	14-161	RCR05G222K
A8CR29	14-103	1N459	A8R17	14-161	RCR05G472K
A8CR3	13-9	1N459	ARR18	14-160	RCR05G222K
A8CR3	14-62	1N459	A8R18	14-160	RCR05G472K
A8CR30	14-104	1N459	ARR19	14-107	RCR05G472K
A8CR31	14-72	1N459	A8R19	14-107	RCR05G222K
A8CR32	13-6A	1N459	ARR2	14-55	RCR05G331K
A8CR32	14-158	1N459	A8R2	13-30	RCR07G822KS
A8CR33	14-71	1N459	ARR20	14-105	RCR05G472K
A8CR34	14-70	1N459	A8R20	14-105	RCR05G222K
A8CR35	14-102	1N459	ARR21	14-157	RCR05G222K
A8CR36	14-138	1N645	A8R21	14-157	RCR05G472K
A8CR37	14-133	1N4001	ARR22	14-156	RCR05G472K
A8CR38	14-95	1N459	A8R22	14-156	RCR05G222K
A8CR39	14-81	1N459	ARR23	14-101	RCR05G222K
A8CR4	14-61	1N459	A8R23	14-101	RCR05G472K
A8CR4	13-10	1N459	A8R24	14-100	RCR05G472K
A8CR40	14-80	1N459	ARR25	14-109	RCR05G822K
A8CR41	14-79	1N459	A8R26	14-108	RCR05GA22K
A8CR42	14-113	1N459	ARR27	14-94	RCR05G472K
A8CR43	14-115A	1N459	A8R27	14-94	RCR05G472K
A8CR5	14-115	1N459	ARR28	14-93	RCR05G472K
A8CR5	13-6	1N459	A8R29	14-92	RCR05G472K
A8CR6	13-5	1N459	ARR3	14-58	RCR05G121K
A8CR6	14-114	1N459	A8R3	13-32	RCR07G822KS
A8CR7	14-117	1N459	ARR30	14-91	RCR05G472K
A8CR7	13-4	1N459	A8R31	14-77	T055-2000-1F
A8CR8	13-3	1N459	ARR32	14-98	T055-4021-1F
A8CR8	14-111	1N459	A8R33	14-75	T055-8060-1F
A8CR9	14-112	1N459	ARR34	14-151	T055-16-2K1F
A8CR9	13-2	1N459	A8R35	14-130	T055-29R4F
A8C1	14-5	CK06BX104M	A8R35	14-130	T055-30R1-1F
A8C10	14-99	CK06RX104M	A8R35	14-130	T055-30R9F
A8C11	14-82	CK06RX104M	A8R35	14-130	T055-31-6-1F
A8C2	14-17	CK06BX104M	A8R35	14-130	T055-32R4F
A8C3	14-48	CK06RX104M	A8R35	14-130	T055-33R2-1F
A8C4	14-42	CK06BX104M	A8R35	14-130	T055-34R0F
A8C5	14-39	CK06BX104M	A8R35	14-130	T055-35R7F
A8C6	14-27	CK06RX104M	A8R35	14-130	T055-36R5-1F
A8C7	14-32	CK06BX104M	ARR36	14-152	T055-100-1F
A8C8	14-53	M39003-01-2003	ARR37	14-154	T055-61-9-1F
A8C9	14-56	M39003-01-201A	A8R37	14-154	T055-59R0-1F
A8K1	14-136	35AV1118A2	ARR37	14-154	55D60R4F
A8Q1	13-25	2N2222A	A8R37	14-154	55D49R9F
A8Q1	14-96	2N2222A	ARR37	14-154	T055-4AR7-1F
A8Q2	14-97	2N2222A	A8R37	14-154	55D63R4F
A8Q3	14-76	2N2222A	ARR37	14-154	55D52R3F
A8Q4	14-78	2N2222A	A8R37	14-154	55D54R9F
A8Q5	14-11	2N2222A	ARR37	14-154	55D47R5F
A8Q6	14-85	2N2222A	A8R37	14-154	55D57R6F
A8Q7	14-132	2N2222A	ARR37	14-154	T055-51-1-1F
A8Q8	14-131	2N2222A	A8R37	14-154	T055-53R6-1F
A8Q9	14-129	2N2222A	ARR37	14-154	T055-56-2-1F
			A8R38	14-153	T055-10K1F

REFERENCE DESIGNATION INDEX

REFERENCE DESIGNATION	FIG - ITEM	PART NUMBER	REFERENCE DESIGNATION	FIG - ITEM	PART NUMBER
ABR39	14-74	T055-10K1F	ABU31	14-29	SM63
ABR4	13-1	RCR07GA22KS	ABU32	14-38	SM63
ABR4	14-54	RCR05G121K	ABU33	14-37	SS226
ABR40	14-90	T055-2000-1F	ABU34	14-30	SM63
ABR41	14-89	T055-4021-1F	ABU35	14-31	SM63
ABR42	14-88	T055-8060-1F	ABU36	14-36	SM63
ABR43	14-87	T055-16-2K1F	ABU37	14-35	SS226
ABR44	14-143	T055-1K1F	ABU38	14-34	SM63
ABR45	14-141	RT22C2P101	ABU39	14-33	SG43
ABR46	14-86	RCR05G102K	ABU4	14-10	SG143
ABR47	14-142	T055-10K1F	ABU40	14-73	RC741T
ABR48	14-139	RT22C2P102	ABU41	14-83	RC741T
ABR49	14-144	T055-1K1F	ABU5	14-1	SG143
ABR5	14-52	RCR07G100KS	ABU6	14-4	SS226
ABR5	13-27	RCR07G822KS	ABU7	14-8	SF103
ABR50	14-145	S5D4990F	ABU8	14-12	SG193
ABR51	14-146	T055-10K1F	ABU9	14-60	SS226
ABR52	14-140	RCR05G472K	A9	12-	783-9480-001
ABR53	14-84	T055-10K1F	A9	1-15	624-5781-001
ABR54	14-135	RCR05G102K	A9	1-15	774-7842-001
ABR55	14-134	RCR05G102K	A9	1-15	793-9414-001
ABR56	14-150	RCR05G472K	A9	11-	793-9414-001
ABR57	14-149	RCR05G472K	A9	4-	774-7842-001
ABR58	14-147	RCR05G472K	A9	1-15	783-9480-001
ABR59	14-148	RCR05G472K	A9	1-42	783-9368-001
ABR6	14-7	RCR05G472K	A9	31-	624-5781-001
ABR60	14-13	RCR05G102K	A9	41-	783-9368-001
ABR61	14-15	RCR05G123K	A9CR1	12-41	1N914
ABR62	14-22	RCR05G123K	A9CR1	4-46	1N4454
ABR63	14-128	RCR05G123K	A9CR1	11-12	1N4150
ABR64	14-127	RCR05G123K	A9CR1	31-42	1N4454
ABR65	14-47	RCR05G472K	A9CR1	41-61	1N914
ABR66	14-156A	RCR05G562K	A9CR10	4-62	1N751
ABR7	14-66	RCR05G822K	A9CR10	31-106	1N751
ABR8	14-2	RCR05G472K	A9CR11	4-117	1N963B
ABR9	14-65	RCR05G472K	A9CR11	31-69	1N963B
ABR9	14-65	RCR05G222K	A9CR2	12-2	1N914
ABU1	14-3	RG373K	A9CR2	4-47	1N4454
ABU1	13-28	SG143	A9CR2	11-13	1N4150
ABU10	14-14	RG373K	A9CR2	31-19	1N4454
ABU11	14-16	RG372K	A9CR2	41-23	1N914
ABU12	14-51	RG372K	A9CR3	11-93	1N4150
ABU13	14-19	SG193	A9CR3	4-45	1N4454
ABU14	14-18	N8266R	A9CR3	12-1	1N914
ABU15	14-67	SG143	A9CR3	31-43	1N4454
ABU16	14-50	SM63	A9CR4	12-42	1N914
ABU17	14-49	SS226	A9CR4	4-74	1N4454
ABU18	14-20	N8233R	A9CR4	31-79	1N4454
ABU19	14-21	SM63	A9CR5	12-44	1N914
ABU2	14-6	98424W	A9CR5	31-84	1N4454
ABU2	13-31	SG143	A9CR6	11-92	1N4150
ABU20	14-46	SM63	A9CR6	12-48	1N914
ABU21	14-45	SS226	A9CR6	31-26	1N4454
ABU22	14-23	N8233R	A9CR7	12-29	1N645
ABU23	14-24	SM73	A9CR7	31-27	1N4454
ABU24	14-44	SM63	A9CR8	12-22	1N971B
ABU25	14-43	SS226	A9CR8	31-45	1N751
ABU26	14-25	N8233R	A9CR9	12-59	1N914
ABU27	14-26	SM63	A9CR9	4-60	1N751
ABU28	14-41	SM63	A9CR9	31-105	1N751
ABU29	14-40	SS226	A9C1	12-4	CM06FD472J03
ABU3	14-9	SG143	A9C1	4-102	8131-100W5R104K
ABU30	14-28	N8233R	A9C1	11-73	CK05BX104K

## REFERENCE DESIGNATION INDEX

REFERENCE DESIGNATION	FIG - ITEM	PART NUMBER	REFERENCE DESIGNATION	FIG - ITEM	PART NUMBER
A9C1	31-40	8131-100W5R104K	A9C22	11-127	8123-000C0G0151J
A9C1	41-59	CK06BX474K	A9C22	4-78	8121-100W5R103K
A9C10	4-107	913-3279-430	A9C22	31-82	8131-100W5R104K
A9C10	11-129	CK05BX104M	A9C23	4-80	913-3279-430
A9C10	12-37	8111-050-651-472 M	A9C23	11-28	8123-000C0G0221F
A9C10	31-95	913-3279-430	A9C23	31-85	913-3279-430
A9C10	41-32	A121-050-651-104 Z	A9C24	11-126	CK05BX103M
A9C100	11-66	CK05BX104K	A9C24	4-81	913-3279-430
A9C101	11-56	CK05RX104K	A9C24	31-86	913-3279-430
A9C102	11-51	151D115X9020W2	A9C25	4-71	DM5C030D050WV
A9C11	12-36	8101-050-651-471 M	A9C25	11-33	CK05BX103M
A9C11	4-85	913-3279-430	A9C25	31-91	DM5C030D050WV
A9C11	11-99	M39003-01-2116	A9C26	11-36	M39003-01-2043
A9C11	31-88	913-3279-430	A9C26	4-5	DM5F331J050WV
A9C11	41-57	A111-050-651-472 M	A9C26	31-53	8121-100W5R102K
A9C12	4-105	DM5C100D050WV	A9C27	11-111	8123-000C0G0151J
A9C12	12-72	M39003-01-2032	A9C27	4-18	8121-050-651-104 Z
A9C12	11-77	CK05BX104K	A9C27	31-51	8121-050-651-104 Z
A9C12	31-94	DM5C100D050WV	A9C28	11-105	CK05BX103M
A9C12	41-34	150D105X9035A2	A9C28	31-103	DM5F151J050WV
A9C13	4-84	8121-050-651-104 Z	A9C29	11-108	DM5C050D050WV
A9C13	12-65	109D187X0010F2	A9C29	4-22	DM5C030D050WV
A9C13	11-75	CK05BX104K	A9C29	31-104	DM5C100D050WV
A9C13	31-89	151D115X9020W2	A9C3	4-100	913-3279-430
A9C14	12-58	8111-050-651-472 M	A9C3	11-20	LP9A1B333F
A9C14	11-59	LP9A1B103F	A9C3	12-51	8101-050-651-471 M
A9C15	11-23	LP9A1B103F	A9C3	31-36	913-3279-430
A9C15	4-3	8121-050-651-104 Z	A9C3	41-55	CK05BX122K
A9C15	12-61	8131-050-651-474 M	A9C30	4-114	913-3279-430
A9C15	31-56	8121-050-651-104 Z	A9C30	11-107	CK05BX103M
A9C16	11-55	DM5E300J050WV	A9C30	31-72	913-3279-430
A9C16	4-8	8121-050-651-104 Z	A9C31	4-111	913-3279-430
A9C16	31-110	8121-050-651-104 Z	A9C31	11-38	CK05BX104M
A9C17	11-34	8123A1B8C0G471F	A9C31	31-98	913-3279-430
A9C17	4-42	M39003-01-2102	A9C32	11-54	8123-000C0G0331J
A9C17	31-10	M39003-01-2043	A9C32	4-15	8121-050-651-104 Z
A9C18	11-49	8123A1B8C0G471F	A9C32	31-2	8121-050-651-104 Z
A9C18	4-49	913-3279-430	A9C33	11-84	CK05BX104M
A9C18	31-48	913-3279-430	A9C33	31-6	8121-050-651-104 Z
A9C19	4-54	913-3279-430	A9C34	11-147	CK05BX104M
A9C19	11-29	CK05BX103M	A9C35	11-80	CK05BX104M
A9C19	31-47	913-3279-430	A9C36	11-40	8123A1B8C0G471F
A9C2	12-49	CM06FD472J03	A9C37	11-39	8123A1B8C0G471F
A9C2	4-101	8131-100W5R104K	A9C38	11-8	CK05BX104M
A9C2	11-71	CK05BX104K	A9C4	11-11	LP9A1B333F
A9C2	31-41	8131-100W5R104K	A9C4	4-89	913-3279-430
A9C2	41-54	CK05BX122K	A9C4	12-66	8121-050-651-104 Z
A9C20	4-75	913-3279-430	A9C4	31-30	913-3279-430
A9C20	11-50	CK05BX103M	A9C4	41-26	CK06BX124K
A9C20	31-80	913-3279-430	A9C40	4-27	913-3279-430
A9C21	4-76	913-3279-430	A9C41	4-30	913-3279-430
A9C21	31-81	913-3279-430	A9C42	4-104	M39003-01-2073
			A9C43	4-103	M39003-01-2073
			A9C44	4-25	CK05BX471K
			A9C45	4-61	CK05BX102K
			A9C46	4-26	CK06BX222K

## REFERENCE DESIGNATION INDEX

REFERENCE DESIGNATION	FIG - ITEM	PART NUMBER	REFERENCE DESIGNATION	FIG - ITEM	PART NUMBER
A9C5	4-97	DM5C100D050WV	A9R1	12-40	T055-3-83K1F
A9C5	11-6	DM5C030D050WV	A9R1	4-99	T055-14-7K1F
A9C5	12-83	8121-050-651-104 Z	A9R1	11-65	RN50C1102F
A9C5	31-33	DM5C100D050WV	A9R1	31-37	T055-14-7K1F
A9C5	41-27	CK058X103K	A9R1	41-52	RCR07G472KS
A9C6	12-87	8121-050-651-104 Z	A9R10	12-63	RCR07G102KS
A9C6	4-92	DM5C030D050WV	A9R10	4-86	RCR05G104K
A9C6	11-9	DM5C150D050WV	A9R10	11-16	RCR05G272JS
A9C6	31-29	DM5C030D050WV	A9R10	31-90	RCR05G104K
A9C6	41-6	8101-050-651-152 M	A9R10	41-38	RCR07G472KS
A9C60	4-79	DM5E620J050WV	A9R100	11-60	C3272G
A9C7	11-141	M39003-01-2043	A9R11	12-30	RCR07G102KS
A9C7	4-44	8121-050-651-104 Z	A9R11	4-48	RCR05G152K
A9C7	12-16	8121-050-651-104 Z	A9R11	11-61	C3153G
A9C7	31-28	151D115X9020W2	A9R11	31-39	RCR05G152K
A9C7	41-11	8111-050-651-222 M	A9R11	41-39	RCR07G472KS
A9C8	12-35	8121-050-651-104 Z	A9R12	12-18	RCR07G472KS
A9C8	11-90	CK058X104M	A9R12	4-43	RCR05G152K
A9C8	4-41	8131-100W5R104K	A9R12	11-14	RN50C1002F
A9C8	31-20	8131-100W5R104K	A9R12	31-18	RCR05G152K
A9C8	41-4	8121-050-651-104 Z	A9R12	41-40	RCR07G472KS
A9C9	4-40	8131-100W5R104K	A9R13	11-104	RL07S392J
A9C9	11-91	CK058X104M	A9R13	4-51	RCR05G103K
A9C9	12-54	8111-050-651-472 M	A9R13	12-56	RCR07G103KS
A9C9	31-21	8131-100W5R104K	A9R13	31-8	RCR05G103K
A9C9	41-16A	8121-050-651-104 Z	A9R13	41-15	RCR07G103KS
A9Q1	4-59	2N2432	A9R14	11-102	C3102G
A9Q1	11-30	F5379	A9R14	4-53	T055-14-7K1F
A9Q1	12-47	2N2222A	A9R14	12-55	RCR07G472KS
A9Q1	31-102	2N2432	A9R14	31-13	T055-14-7K1F
A9Q1	41-19	2N2222A	A9R14	41-16	RCR07G103KS
A9Q2	12-46	2N2222A	A9R15	11-96	RW70U2740F
A9Q2	4-34	2N2432	A9R15	4-56	T055-10K1F
A9Q2	11-37	2N4045	A9R15	12-53	RCR07G221KS
A9Q2	31-99	2N2432	A9R15	31-7	T055-10K1F
A9Q2	41-30	2N2222A	A9R15	41-13	RCR07G103KS
A9Q3	11-122	2N5066	A9R16	11-89	C3752G
A9Q3	4-64	2N2222A	A9R16	12-38	RCR07G221KS
A9Q3	12-86	2N2222A	A9R16	4-72	RCR05G102K
A9Q3	31-107	2N2222A	A9R16	31-77	RCR05G102K
A9Q3	41-24	2N6027	A9R16	41-14	RCR07G103KS
A9Q4	11-121	2N5066	A9R17	12-20	RCR07G183KS
A9Q4	12-33	2N2222A	A9R17	4-73	RCR05G102K
A9Q4	4-23	2N2907A	A9R17	11-68	RN50C1003F
A9Q4	31-62	2N2907A	A9R17	31-78	RCR05G102K
A9Q5	12-25	2N2222A	A9R17	41-35	RCR07G102KS
A9Q5	4-113	2N2222A	A9R18	12-70	RCR07G470KS
A9Q5	11-112	2N4855	A9R18	11-67	RN50C1003F
A9Q5	31-67	2N2222A	A9R18	31-93	RCR05G472K
A9Q6	4-116	2N2907A	A9R18	41-62	RCR07G221KS
A9Q6	11-106	2N4855	A9R19	4-77	RCR05G562K
A9Q6	31-70	2N2907A	A9R19	11-57	RN50C3161F
A9Q7	11-103	2N3486A	A9R19	12-68	RCR07G183KS
			A9R19	31-83	RCR05G822K
			A9R19	41-18	RCR07G472KS
			A9R2	12-45	T055-3-83K1F
			A9R2	4-98	T055-14-7K1F
			A9R2	11-64	RN50C1102F
			A9R2	31-38	T055-14-7K1F
			A9R2	41-53	RCR07G472KS
			A9R20	4-67	RCR05G223K
			A9R20	11-58	RN50C3161F
			A9R20	12-69	RCR07G470KS

## REFERENCE DESIGNATION INDEX

REFERENCE DESIGNATION	FIG - ITEM	PART NUMBER	REFERENCE DESIGNATION	FIG - ITEM	PART NUMBER
A9R20	31-73	RCR05G223K	A9R34	4-109	T055-10K1F
A9R20	41-20	RCR07G473KS	A9R34	11-97	C3102G
A9R21	12-26	RCR07G151KS	A9R34	31-96	T055-10K1F
A9R21	11-52	T055-301000-1F	A9R35	11-133	RCR05G332K
A9R21	31-44	RN65D1960F	A9R35	4-31	T055-5-11K1F
A9R21	41-21	RCR07G472KS	A9R35	31-66	T055-5-11K1F
A9R22	12-23	RCR07G472KS	A9R36	11-132	C3471G
A9R22	11-53	T055-301000-1F	A9R36	4-32	T055-5-11K1F
A9R22	31-58	RCR05G103K	A9R36	31-101	T055-5-11K1F
A9R22	41-29	T055-3-16K1F	A9R37	11-131	C3471G
A9R23	12-24	RCR07G101KS	A9R37	4-33	T055-5-11K1F
A9R23	11-94	RCR05G332K	A9R37	31-100	T055-5-11K1F
A9R23	4-12	RCR05G332K	A9R38	11-22	C3431G
A9R23	31-4	RCR05G332K	A9R38	4-29	T055-1542-1F
A9R23	41-31	T055-7-5K1F	A9R38	31-65	T055-1542-1F
A9R24	11-143	RCR05G332K	A9R39	11-31	RN50C2741F
A9R24	4-6	RCR05G332K	A9R39	4-28	T055-100-1F
A9R24	12-62	RCR07G472KS	A9R39	31-64	T055-100-1F
A9R24	31-59	RCR05G332K	A9R4	12-43	T055-332000-1F
A9R24	41-25	T055-121K1F	A9R4	4-94	T055-100-1F
A9R25	11-142	C3752G	A9R4	11-69	RN50C1181F
A9R25	12-31	RCR07G122KS	A9R4	31-34	T055-100-1F
A9R25	4-10	RCR05G151K	A9R4	41-48	RCR07G472KS
A9R25	31-111	RCR05G151K	A9R40	11-32	RN50C2741F
A9R25	41-28	RCR07G472KS	A9R40	4-21	RCR05G103K
A9R26	12-60	RCR07G221KS	A9R40	31-61	RCR05G103K
A9R26	11-26	C3103G	A9R41	11-144	C3183G
A9R26	4-13	RCR05G332K	A9R41	4-63	RCR05G560K
A9R26	31-49	RCR05G332K	A9R41	31-108	RCR05G560K
A9R26	41-43	RCR07G472KS	A9R42	4-115	RCR05G102K
A9R27	12-57	RCR07G221KS	A9R42	11-117	C3152G
A9R27	4-57	T055-7-5K1F	A9R42	31-74	RCR05G102K
A9R27	31-11	T055-7-5K1F	A9R43	11-116	C3152G
A9R27	41-42	RCR07G472KS	A9R43	4-66	RCR05G392K
A9R28	11-128	RN50C5361F	A9R43	31-71	RCR07G392KS
A9R28	4-36	T055-7-5K1F	A9R44	4-112	RCR05G102K
A9R28	31-15	T055-7-5K1F	A9R44	11-123	C3133G
A9R28	41-41	RCR07G472KS	A9R44	31-68	RCR05G102K
A9R29	4-55	T055-1541-1F	A9R45	11-124	C3133G
A9R29	11-27	T055-215K1F	A9R45	4-2	RCR05G332K
A9R29	31-12	T055-1541-1F	A9R45	31-55	RCR05G332K
A9R29	41-2	RCR07G472KS	A9R46	4-83	RCR05G102K
A9R3	12-39	RT22C2P103	A9R46	11-118	RN50C1002F
A9R3	4-95	T055-100-1F	A9R46	31-87	RCR05G102K
A9R3	11-70	RN50C1181F	A9R47	11-115	RN50C1002F
A9R3	31-35	T055-100-1F	A9R48	11-120	RN50C4991F
A9R3	41-51	RCR07G472KS	A9R49	11-114	RN50C4991F
A9R30	11-43	RN50C1541F	A9R5	12-3	T055-42-2K1F
A9R30	4-35	T055-1541-1F	A9R5	4-91	RCR05G104K
A9R30	31-16	T055-1541-1F	A9R5	11-72	RN50C3162F
A9R30	41-58	RCR07G221KS	A9R5	31-31	RCR05G104K
A9R31	4-108	T055-13-1K1F	A9R5	41-47	RCR07G472KS
A9R31	11-42	RN50C1272F	A9R50	11-119	RN50C4991F
A9R31	31-17	T055-13-1K1F	A9R50	4-52	RCR05G332K
A9R31	41-9	RCR07G101KS	A9R51	11-113	RN50C1502F
A9R32	4-37	T055-13-1K1F	A9R51	4-68	RCR05G332K
A9R32	11-44	RCR05G104JS	A9R52	11-110	RCR05G103K
A9R32	31-14	T055-13-1K1F	A9R52	4-65	RCR05G332K
A9R32	41-33	RCR07G391KS	A9R53	11-135	C3560G
A9R33	4-110	T055-10K1F	A9R53	4-82	RCR05G272K
A9R33	11-41	C3103G	A9R54	4-90	RCR05G152K
A9R33	31-97	T055-10K1F	A9R54	11-24	C3103G
A9R33	41-8	RCR07G472KS	A9R55	4-106	RCR05G152K

REFERENCE DESIGNATION INDEX

REFERENCE DESIGNATION	FIG - ITEM	PART NUMBER	REFERENCE DESIGNATION	FIG - ITEM	PART NUMBER
A9R55	11-18	RN50C1000F	A9U22	41-7	SG8303
A9R56	11-81	RCR07G392JS	A9U23	12-19	MC836P
A9R57	11-3	RCR07G392JS	A9U23	4-20	SN74H103N
A9R58	11-46	RN50C2672F	A9U23	31-112	SF10303
A9R59	11-45	RN50C2672F	A9U24	12-27	MCT2
A9R6	4-38	T055-26-1K1F	A9U24	4-4	SN74H103N
A9R6	11-74	RN50C3162F	A9U24	31-57	RF101D
A9R6	12-50	RCR07G103KS	A9U301	11-79	CF81
A9R6	31-22	T055-26-1K1F	A9U302	11-4	RG371K
A9R6	41-45	RCR07G472KS	A9U303	11-146	RG191K
A9R60	11-21	RCR05G332K	A9U304	11-87	RF101K
A9R61	11-47	RN50C2672F	A9U31	12-75	DM7486N
A9R62	11-48	RN50C2672F	A9U31	41-60	S8A80A
A9R63	11-101	RCR05G270K	A9U32	4-11	SN7474N
A9R64	11-100	C3102G	A9U32	12-74	MC7400P
A9R7	11-76	RN50C2261F	A9U32	31-5	SN7474N
A9R7	4-39	T055-26-1K1F	A9U32	41-10	S8A80A
A9R7	12-52	RCR07G222KS	A9U33	12-17	SN7474N
A9R7	31-23	T055-26-1K1F	A9U33	4-9	MC7400P
A9R7	41-49	RCR07G472KS	A9U33	31-109	MC7400P
A9R8	4-96	T055-100-1F	A9U34	12-28	MCT2
A9R8	11-17	C3112G	A9U34	4-7	MC7404P
A9R8	31-24	T055-100-1F	A9U34	31-60	MC7404P
A9R8	41-44	RCR07G472KS	A9U401	11-78	SG341
A9R9	12-32	RCR07G153KS	A9U402	11-5	CF81
A9R9	4-88	T055-100-1F	A9U403	11-145	RG141K
A9R9	11-15	RN50C3161F	A9U404	11-88	RG81K
A9R9	31-25	T055-100-1F	A9U41	12-77	SN74151N
A9R9	41-46	RCR07G472KS	A9U41	41-56	S8822A
A9T1	11-137	677-0390-010	A9U42	12-76	MC7402P
A9T1	4-58	8-879	A9U42	41-12	SG8303
A9T1	31-9	754	A9U43	12-15	MC7410P
A9U101	11-83	SG341	A9U502	11-7	LM101AF
A9U101	12-88	MC7493P	A9U51	4-50	LM311H
A9U102	12-7	SN74H103N	A9U51	12-79	S8266B
A9U102	11-1	RF100K	A9U51	31-46	LM301AH
A9U103	12-5	MC7404P	A9U51	41-50	S8280A
A9U103	11-149	UJL931251	A9U52	12-78	MC7404P
A9U104	11-85	SF51	A9U52	41-17	S8822A
A9U11	12-67	SN7408N	A9U53	12-14	SN7473N
A9U11	41-3	S8281A	A9U53	4-24	U5F7715393
A9U111	12-89	MC7402P	A9U53	31-63	LM301AH
A9U112	12-6	SN7473N	A9U602	11-10	LM101F
A9U12	12-71	SG8303	A9U603	11-138	LM101F
A9U12	4-17	MC7402P	A9U61	4-93	U5B770939
A9U12	31-1	MC7402P	A9U61	12-81	SN74164N
A9U12	41-5	S8816A	A9U61	31-32	U5B770939
A9U13	12-21	MC7410P	A9U61	41-37	S8280A
A9U13	4-19	SN74H74N	A9U62	4-87	U5B770939
A9U13	31-52	SN7474N	A9U62	12-80	MC7402P
A9U14	4-1	SN74H103N	A9U62	31-92	U5B770939
A9U14	31-54	SF10303	A9U62	41-22	S8890A
A9U201	11-82	SG71	A9U63	12-13	MC7400P
A9U202	11-2	RF101K	A9U63	4-70	LM311H
A9U203	11-148	RF101K	A9U63	31-76	LM301AH
A9U204	11-86	RF101K	A9U64	4-69	LM311H
A9U21	12-64	MC7402P	A9U64	31-75	LM301AH
A9U21	4-14	U6B931259	A9U71	12-82	S8415A
A9U21	31-50	U6B931259	A9U71	41-36	S8280A
A9U21	41-1	S8880A	A9U72	12-12	S8266B
A9U22	12-73	MC7400P	A9U73	12-34	SN7473N
A9U22	4-16	MC7401P	A9U801	11-35	LM101AF
A9U22	31-3	MC7401P	A9U802	11-25	LM101F

## REFERENCE DESIGNATION INDEX

REFERENCE DESIGNATION	FIG - ITEM	PART NUMBER	REFERENCE DESIGNATION	FIG - ITEM	PART NUMBER
A9U803	11-130	J3F7710312	C210	40-12	601D108G050JL6
A9U81	12-84	MC7402P	C3	30-27	8131-050-651-104
A9U82	12-11	SN74197N			M
A9U83	12-10	SN7427N	C3	29-3	150D475X0035R2
A9U903	11-125	LM101AF	C301	28-8	2C067104X0101A3
A9U904	11-109	LM101AF	C302	28-9	2C067104X0101A3
A9U91	12-85	MC7400P	C303	28-13	2C067104X0101A3
A9U92	12-9	SN7474N	C4	30-26	150D226X9035R2
A9U93	12-8	MC7400P	C4	29-25	K05SK102M
A9VR1	11-139	LM103H3-9	C405	26-17	M39003-01-2015
A9VR1	12-22	1N971B	C406	26-18	M39003-01-2026
A9VR10	11-134	1N750A	C5	30-23	150D226X9035R2
A9VR11	11-136	1N750A	C5	29-23	M39003-01-2067
A9VR12	11-63	1N746A	C501	27-4	2C067104X0101A3
A9VR13	11-62	1N4649	C502	27-10	M39003-01-2029
A9VR3	11-95	1N4656	C6	30-13	M39003-03-0045
A9VR5	11-19	LM103H3-9	C6	29-22	2C067473X0101A3
A9VR7	11-98	1N963B	C7	30-10	DM5F271J050WV
B201	40-3	A074675	C7	29-21	600D227G020DG5
CR1	30-17	1N4003	C8	30-18	8131-050-651-104
CR1	29-15	1N4003			M
CR105	40-41	1N459	C8	29-9	2C067182X0101A3
CR106	40-40	1N459	C9	29-29	M39003-01-2070
CR201	40-27	1N4003	C9	30-21	600D507G020DL5
CR203	40-8	1N1200R	DS101	39-7	M324515-685
CR204	40-7	1N1200R	DS104	39-76	62
CR205	40-24	1N4003	DS105	39-78	62
CR206	40-23	1N4003	FL201	40-51	A188
CR207	40-25	1N5198	F201	40-55	MDL1 1-2
CR207	40-25	1N5550	F202	40-56	MDL1 1-2
CR208	40-22	1N5198	J11	26-33	609-0792-001
CR208	40-22	1N5550	J12	26-35	609-0792-001
CR301	28-5	1N914	J13	26-38	609-0792-001
CR302	28-4	1N914	J14	26-44	609-0792-001
CR303	28-11	1N914	J15	26-30	609-0792-001
CR304	28-10	1N914	J16	26-27	609-0792-001
CR501	27-9	1N4003	J18	26-31	609-0792-001
CR502	27-7	1N4003	J19	26-39	609-0792-001
C1	30-3	150D474X9035A2	J20	26-40	609-0792-001
C1	29-31	M39003-01-2108	J21	26-41	609-0792-001
C10	29-27	8131-050-651-104	J22	26-34	609-0792-001
		M	J23	26-45	609-0792-001
C10	30-22	600D507G020DL5	J24	26-28	609-0792-001
C101	39-39	M39003-01-2050	J25	26-26	609-0792-001
C102	40-48	M39003-01-2111	J28	26-25	609-0792-001
C103	39-15	2C067102X0101A3	J29	26-47	609-0792-001
C104	39-14	2C067102X0101A3	J3	26-32	609-0792-001
C11	30-29	8131-050-651-104	J35	26-59	609-0792-001
		M	J36	26-49	609-0792-001
C11	29-14	M39003-01-2026	J37	26-60	609-0792-001
C12	30-8	8131-050-651-104	J38	26-48	609-0792-001
		M	J4	26-36	609-0792-001
C13	30-6	M39003-03-0015	J40	26-24	609-0792-001
C2	29-2	150D475X0035B2	J41	26-51	609-0792-001
C2	30-31	150D226X9035R2	J42	26-50	609-0792-001
C201	40-50	41C157	J43	26-23	609-0792-001
C202	40-49	41C157	J45	26-53	609-0792-001
C204	40-14	36C175A	J46	26-52	609-0792-001
C205	26-7	36D303G015CC2A	J47	26-58	609-0792-001
C206	40-19	36C175A	J48	26-22	609-0792-001
C207	26-8	36D902G050BC2A	J5	26-42	609-0792-001
C208	40-20	36C175A	J50	26-21	609-0792-001
C209	40-21	36C175A	J51	26-55	609-0792-001

REFERENCE DESIGNATION INDEX

REFERENCE DESIGNATION	FIG - ITEM	PART NUMBER	REFERENCE DESIGNATION	FIG - ITEM	PART NUMBER
J52	26-56	609-0792-001	R120	39-51	55D47R5F
J54	26-57	609-0792-001	R121	39-52	55D47R5F
J55	26-54	609-0792-001	R122	39-53	55D47R5F
J57	39-20	PT02A16-8P	R123	39-41	55D2100F
J58	39-70	11J1043	R124	39-42	55D2210F
J59	40-62	M39012-21-0001	R125	39-83	RCR05G153JS
J6	26-29	609-0792-001	R126	39-84	RCR05G153JS
J60	40-61	M39012-21-0001	R127	39-85	RCR05G153JS
J61	40-60	M39012-21-0001	R128	39-126	RCR05G153JS
J62	39-19	JT02A14-37P014	R129	39-128	RCR05G153JS
J63	39-18	JT02A14-37PA014	R13	30-9	RCR07G471KS
J64	40-58	3501FP	R13	29-11	RW70U1ROOF
J65	40-59	M39012-21-0001	R130	39-129	RCR05G153JS
J66	26-46	609-0792-001	R131	39-82	RCR05G153JS
J69	26-61	609-0792-001	R132	39-127	RCR20G820KS
J7	26-43	609-0792-001	R133	39-87	RCR05G153JS
J8	26-37	609-0792-001	R134	39-88	RCR05G153JS
L1	29-18	2890-30	R135	39-89	RCR05G153JS
L201	40-16	668-0240-010	R136	39-122	RCR05G153JS
L202	40-15	668-0241-010	R137	39-123	RCR05G153JS
L301	28-12	MS90537-49	R138	39-125	RCR05G153JS
M101	39-1	458-0840-010	R139	39-86	RCR05G153JS
Q1	30-34	2N2222A	R14	30-20	RCR07G221KS
Q1	29-7	2N3054	R14	29-17	RW67V3R3
Q2	30-35	2N2907A	R140	39-124	RCR20G820KS
Q2	29-12	2N3740	R141	39-91	RCR05G153JS
Q201	40-6	2N3716	R142	39-92	RCR05G153JS
Q202	40-9	2N3741	R143	39-93	RCR05G153JS
Q203	40-5	2N3716	R144	39-118	RCR05G153JS
Q3	30-37	2N3054	R145	39-119	RCR05G153JS
Q3	30-37	2N3766	R146	39-121	RCR05G153JS
Q4	30-38	2N3766	R147	39-90	RCR05G153JS
Q4	30-38	2N3054	R148	39-120	RCR20G820KS
Q5	30-40	2N3740	R149	39-95	RCR05G153JS
Q501	27-18	2N3740	R15	30-11	RCR07G100KS
Q502	27-2	2N1711	R15	29-13	RCR07G470KS
Q503	27-14	2N2222A	R150	39-96	RCR05G153JS
Q504	27-15	2N2907A	R151	39-97	RCR05G153JS
R1	29-1	RCR07G474KS	R152	39-114	RCR05G153JS
R1	29-1	RCR07G564KS	R153	39-115	RCR05G153JS
R1	29-1	RCR07G684KS	R154	39-117	RCR05G153JS
R1	29-1	RCR07G754JS	R155	39-94	RCR05G153JS
R1	29-1	RCR07G824KS	R156	39-116	RCR20G820KS
R1	30-1	RCR07G274KS	R157	39-99	RCR05G153JS
R10	30-15	RCR07G101KS	R158	39-100	RCR05G153JS
R10	29-5	RCR07G472KS	R159	39-101	RCR05G153JS
R101	39-60	RA20SASD252A	R16	30-14	RW70U1ROOF
R102	39-37	T055-61-9-1F	R160	39-110	RCR05G153JS
R102	39-37	T055-61-9-1F	R161	39-111	RCR05G153JS
R102	39-37	T055-619-1F	R162	39-113	RCR05G153JS
R102	39-37	T055-619-1F	R163	39-98	RCR05G153JS
R11	30-16	RCR07G331KS	R164	39-112	RCR20G820KS
R11	29-16	RCR20G102KS	R165	39-103	RCR05G153JS
R112	39-43	55D47R5F	R166	39-104	RCR05G153JS
R113	39-44	55D47R5F	R167	39-105	RCR05G153JS
R114	39-45	55D47R5F	R168	39-106	RCR05G153JS
R115	39-46	55D47R5F	R169	39-107	RCR05G153JS
R116	39-47	55D47R5F	R17	30-12	RW70U1ROOF
R117	39-48	55D47R5F	R170	39-109	RCR05G153JS
R118	39-49	55D47R5F	R171	39-102	RCR05G153JS
R119	39-50	55D47R5F	R172	39-108	RCR20G820KS
R12	30-19	RCR07G222KS	R173	40-42	RCR07G222KS
R12	29-6	RW70U1ROOF	R174	39-68	RCR20G101KS



## REFERENCE DESIGNATION INDEX

REFERENCE DESIGNATION	FIG - ITEM	PART NUMBER	REFERENCE DESIGNATION	FIG - ITEM	PART NUMBER
R175	39-61	RV2NAYS D103D	TB101	40-63	410MY6
R175	39-61	BA178003	TB103	40-44	606-9724-001
R176	39-27	RCR07G101KS	TB104	29-35	606-9886-001
R177	39-55	RCR05G822JS	TB104	30-42	618-7104-001
R178	39-57	RCR05G822JS	TB106	40-64	410MY2
R179	39-58	RCR05G822JS	TB201	40-31	606-9723-001
R18	30-28	RCR07G471KS	T201	40-34	662-0534-010
R18	29-4	RCR07G100KS	T301	28-2	606-9713-001
R180	39-56	RCR05G822JS	T302	28-3	606-9713-001
R181	39-38	55D80R6F	U1	29-28	GEL24681
R181	39-38	55D8060F	VR501	27-11	1N750A
R181	39-38	55D80R6F	V101	1-25	DT1704C
R181	39-38	55D8060F	V102	1-26	DT1704C
R182	39-54	55D47R5F	V103	1-27	DT1704C
R183	39-69	RCR20G101KS	V104	1-28	DT1704C
R185	39-40	RCR32G470KS	V105	1-29	DT1704C
R186	40-39	RCR07G472KS	V106	1-30	DT1704C
R187	40-43	RCR07G103KS	XF201, XF202	40-57	HTA
R189	39-60A	RCR05G223K			
R19	30-7	RCR07G150KS			
R2	30-2	RCR07G223KS			
R2	29-32	RCR07G753JS			
R201	40-28	RCR32G180KS			
R203	26-5	RCR20G222KS			
R204	40-26	RW67V120			
R205	26-4	RCR20G471KS			
R206	40-13	RE70G1001			
R3	29-30	RCR07G123KS			
R3	30-33	RCR07G103KS			
R301	28-6	RCR05G102K			
R302	28-7	RCR05G102K			
R4	30-32	RCR07G182KS			
R4	29-26	RCR07G102KS			
R5	30-25	RCR07G471KS			
R5	29-24	RCR07G183KS			
R501	27-6	RCR07G122KS			
R502	27-5	RCR20G270KS			
R503	27-13	RCR20G101KS			
R504	27-12	RCR07G270KS			
R505	27-8	RCR07G180KS			
R506	27-1	RCR07G102KS			
R507	27-3	RCR07G122KS			
R6	30-5	RCR07G822KS			
R6	29-8	RCR07G334KS			
R7	30-4	RCR07G181KS			
R7	29-20	RCR07G220KS			
R8	30-24	RCR07G222KS			
R8	29-10	RCR07G823KS			
R9	30-30	RCR07G221KS			
R9	29-19	RCR20G102KS			
S101	39-62	280100K2			
S102	39-63	280103K1			
S103	39-32	38425SMLR			
S104	39-30	38423SMLR			
S105	39-31	38425SMLR			
S107	39-33	38422SMLR			
S108	39-34	38424SMLR			
S109	39-17	610-2150-001			
S110	39-25	39352-48LR1			
S111	39-24	39352-48LR1			
S112	39-59	276805CK3			
S113	39-26	G111SPDT			
S201	40-10	C4344-207-4			

